

Illustrations
Study Guide
CD-ROM
FREE INTERNET

BIOCHEMISTRY

THIRD EDITION

MATHEWS | VAN HOLDE | AHERN

choose a chapter

1	2	3	4
5	6	7	8
9	10	11	12
13	14	15	16
17	18	19	20
21	22	23	24
25	26	27	28

requirements
index

welcome

Welcome to the *Companion Web Site* that accompanies the third edition of *Biochemistry* by Mathews, van Holde, and Ahern. At a time when major technological advances are occurring in both electronics and biochemistry, it is fitting that a web site accompanies this important biochemistry textbook.

Companion Web Site Requirements

To fully utilize this Companion Web Site it is important to understand the [requirements](#).

Get Started!

Click on one of the chapters in the "choose a chapter" table to the left.

Features of This Companion Web Site

Each chapter in the textbook has a corresponding section on the Companion Web Site that contains *Outlines*, *Concepts*, *Terminology*, and *Quizzing* to help you succeed in your Biochemistry course.

- *Outlines* sections parallel the organization of the individual chapters in the textbook, with hyperlinks to key concepts, figures, and pathways.
- *Concepts* sections contain hyperlinked summaries of the important concepts from each chapter.
- *Terminology* sections, which define the important terms from the text on a chapter-by-chapter basis, also include hyperlinks to appropriate figures.
- *Quizzing* sections help you learn and retain the numerous terms, names, structures, enzymes, and pathways encountered in biochemistry. The *Quizzing* sections contain over 6000 queries to give you a thorough review and to make it possible to return many times without encountering the same question twice.

CD-ROM Access

When you're not on-line you can continue your study of biochemistry by using the CD-ROM found in the back of the book. The material available on this web site can also be found on the CD-ROM.

Connectivity to Expanded Information on the Internet

The internet provides an incredible amount of information in Biochemistry. We have included hyperlinks between the concepts, enzymes, and molecules covered on the Companion Web Site to related information found on hundreds of external web sites. In doing so, the Companion Web Site provides an intellectual bridge between the textbook and an evolving body of knowledge that will undoubtedly grow with time, making this site a tool for learning biochemistry and an ongoing reference.

chapter one

outline | concepts
terminology | quizzing

1 2 3 4
5 6 7 8
9 10 11 12
13 14 15 16
17 18 19 20
21 22 23 24
25 26 27 28

help | index

Outline

Introduction ([Figure 1.1](#))

Revolution in biological sciences

Designing Molecules

[6-Mercaptopurine](#)

[3'-Azido-2',3'-dideoxythymidine \(AZT\)](#)

[Isoproterenol](#)

What is Biochemistry?

Goals of Biochemistry

Describe structure, organization, function of cells in molecular terms.

Structural Chemistry

Metabolism

Molecular Genetics

[Roots of Biochemistry \(Figure 1.3\)](#)

Wohler's synthesis of urea

Buchners' fermentation of sugar from yeast extracts

Sumner's crystallization of urease

Flemming's discovery of chromosomes

Mendel's characterization of genes

Miescher's isolation of nucleic acids

Watson and Crick's structure of DNA

Biochemistry as a Discipline

[Biochemistry as a Chemical Science](#)

[Amino acids](#)

[Sugars](#)

[Lipids](#)

[Nucleotides](#)

[Vitamins](#)

[Hormones](#)

Chemical Elements of Living Matter ([Figure 1.4](#), [Table 1.1](#))

[Biological Molecules](#)

Monomers/Polymers ([Figure 1.7](#))

[Sugar/Polysaccharide](#)

[Nucleotide/Nucleic Acids](#)

Biochemistry as a Biological Science

Distinguishing Characteristics of Living Matter

Constant renewal of a highly ordered structure accompanied by an increase in complexity of that structure

Overcoming entropy requires energy

Life is self-replicating

Unit of Biological Organization: The Cell (Figure 1.8, Figure 1.9)

Prokaryotes (Table 1.2)

Eubacteria

Archaeobacteria

Eukaryotes (Compartmentalization of organelles) (Figure 1.11, Figure 1.13)

Windows on Cellular Functions: The Viruses

New Tools in the Biological Revolution(Figure 1.15)

The Uses of Biochemistry

Agriculture

Medicine

Nutrition

Clinical Chemistry

Pharmacology

Toxicology

Outline

Introduction ([Figure 1.1](#))

Revolution in biological sciences

Designing Molecules

[6-Mercaptopurine](#)

[3'-Azido-2',3'-dideoxythymidine \(AZT\)](#)

[Isoproterenol](#)

What is Biochemistry?

Goals of Biochemistry

Describe structure, organization, function of cells in molecular terms.

Structural Chemistry

Metabolism

Molecular Genetics

[Roots of Biochemistry](#) ([Figure 1.3](#))

Wohler's synthesis of urea

Buchners' fermentation of sugar from yeast extracts

Sumner's crystallization of urease

Flemming's discovery of chromosomes

Mendel's characterization of genes

Miescher's isolation of nucleic acids

Watson and Crick's structure of DNA

Biochemistry as a Discipline

[Biochemistry as a Chemical Science](#)

[Amino acids](#)

[Sugars](#)

Lipids

Nucleotides

Vitamins

Hormones

Chemical Elements of Living Matter(Figure 1.4, Table 1.1)

Biological Molecules

Monomers/Polymers (Figure 1.7)

Sugar/Polysaccharide

Nucleotide/Nucleic Acids

Amino acid/Polypeptides (Figure 1.6)

Biochemistry as a Biological Science

Distinguishing Characteristics of Living Matter

Constant renewal of a highly ordered structure accompanied by an increase in complexity of that structure

Overcoming entropy requires energy

Life is self-replicating

Unit of Biological Organization: The Cell (Figure 1.8, Figure 1.9)

Prokaryotes (Table 1.2)

Eubacteria

Archaeobacteria

Eukaryotes (Compartmentalization of organelles) (Figure 1.11, Figure 1.13)

Windows on Cellular Functions: The Viruses

New Tools in the Biological Revolution(Figure 1.15)

The Uses of Biochemistry

Agriculture

Medicine

Nutrition

Clinical Chemistry

Pharmacology

Toxicology

Figure 1.1: Medical applications of biochemistry.

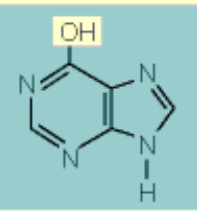
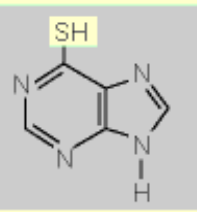
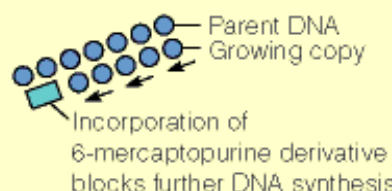
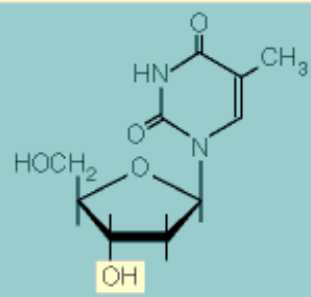
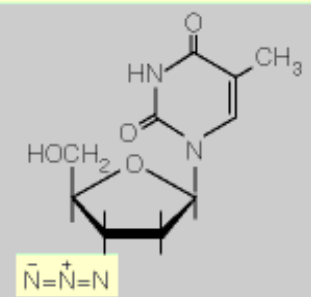
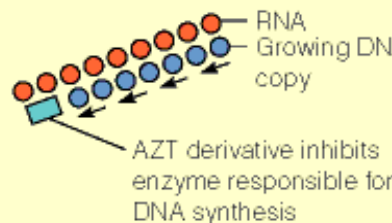
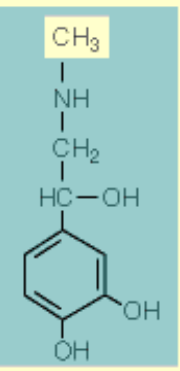
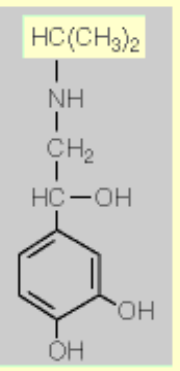
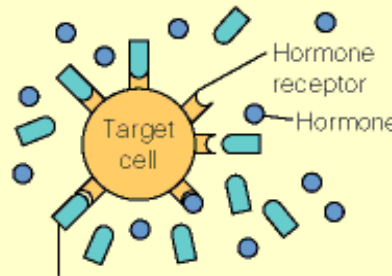
Normal biological molecule	Analog used as drug	Application
 <p>Hypoxanthine, a precursor of purine bases in DNA and RNA</p>	 <p>6-mercaptopurine, a hypoxanthine analog that blocks nucleic acid synthesis</p>	 <p>Parent DNA Growing copy Incorporation of 6-mercaptopurine derivative blocks further DNA synthesis</p>
 <p>Thymidine, a normal constituent of DNA</p>	 <p>3'-azido-2',3'-dideoxythymidine (AZT), an inhibitor of the RNA-directed DNA synthesis of the AIDS virus</p>	 <p>RNA Growing DNA copy AZT derivative inhibits enzyme responsible for DNA synthesis</p>
 <p>Epinephrine, an adrenal hormone that controls many cellular functions</p>	 <p>Isoproterenol; by binding to certain membrane receptors for epinephrine, it mimics the action of this hormone</p>	 <p>Target cell Hormone receptor Hormone Binding of isoproterenol mimics hormone binding to target cell, thereby blocking stimulation</p>

6-Mercaptopurine

6-Mercaptopurine is an analog of [hypoxanthine](#), an intermediate in purine nucleotide biosynthesis. When **mercaptopurine** is made into a [nucleotide](#) by a cell, it stops DNA replication from occurring because it is incorporated into DNA by DNA polymerase instead of the proper nucleotide.

6-Mercaptopurine is an anticancer medication. It inhibits the uncontrolled DNA replication associated with proliferation of white blood cells in leukemia.

See also: [DNA](#), [Purines](#), [De Novo Biosynthesis of Purine Nucleotides](#), [DNA Replication Overview](#)

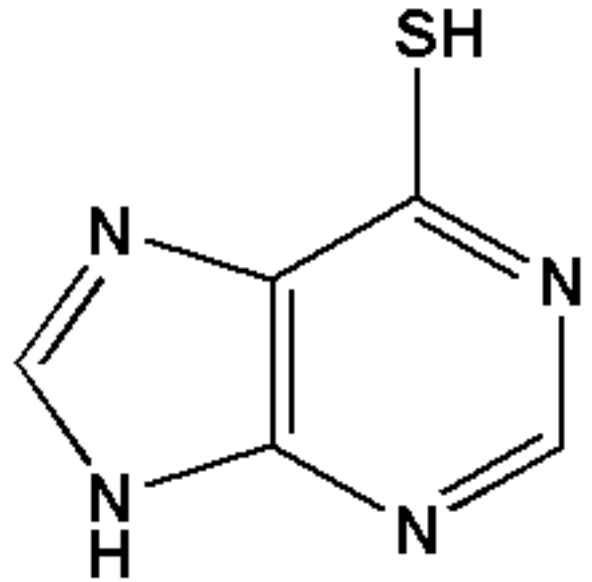

6-Mercaptopurine

Hypoxanthine

Hypoxanthine is a base found in an intermediate of purine nucleotide biosynthesis. [Figure 22.4](#) summarizes the pathway leading from phosphoribosyl-1-pyrophosphate ([PRPP](#)) to the first fully formed purine nucleotide, inosine 5'-monophosphate ([IMP](#)), also called inosinic acid. IMP contains as its base, **hypoxanthine**.

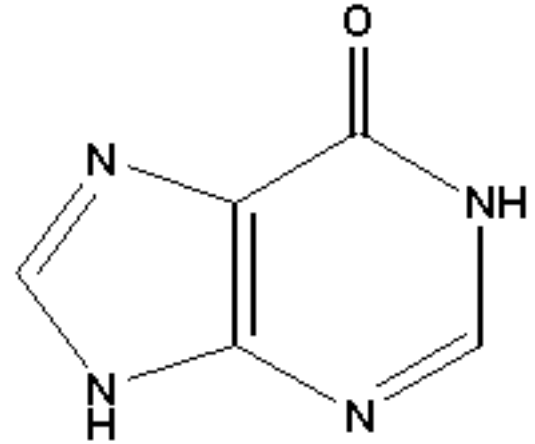

Hypoxanthine

Hypoxanthine is also a product of catabolism of purine nucleotides ([Figure 22.7](#)). Hypoxanthine can be converted to xanthine by the enzyme [xanthine oxidase](#) in the reaction that follows:

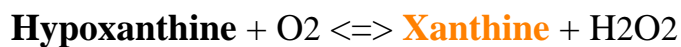

In addition, **hypoxanthine** can be converted back to IMP in purine nucleotide salvage biosynthesis (by the enzyme [HGPRT](#)), as shown in [Figure 22.9](#).

Complete deficiency of HGPRT results in gout-related arthritis, dramatic malfunction of the nervous system, behavioral disorders, learning disability, and hostile or aggressive behavior, often self directed. In the most extreme cases, patients nibble at their fingertips or, if restrained, their lips, causing severe self-mutilation.

Allopurinol, which is similar to **hypoxanthine** (see [here](#)), is used to treat gout because it inhibits [xanthine oxidase](#), leading to accumulation of **hypoxanthine** and [xanthine](#), both of which are more soluble and more readily excreted than [uric acid](#), the chemical that causes gout.

See also: [De Novo Biosynthesis of Purine Nucleotides](#), [Purine Degradation](#), [Excessive Uric Acid in Purine Degradation](#), [Salvage Routes to Deoxyribonucleotide Synthesis](#), [Nucleotide Analogs in Selection](#)

INTERNET LINKS:

1. Purine Metabolism

2. Purine and Pyrimidine Metabolism

Figure 22.4: *De novo* biosynthesis of the purine ring, from PRPP to inosinic acid.

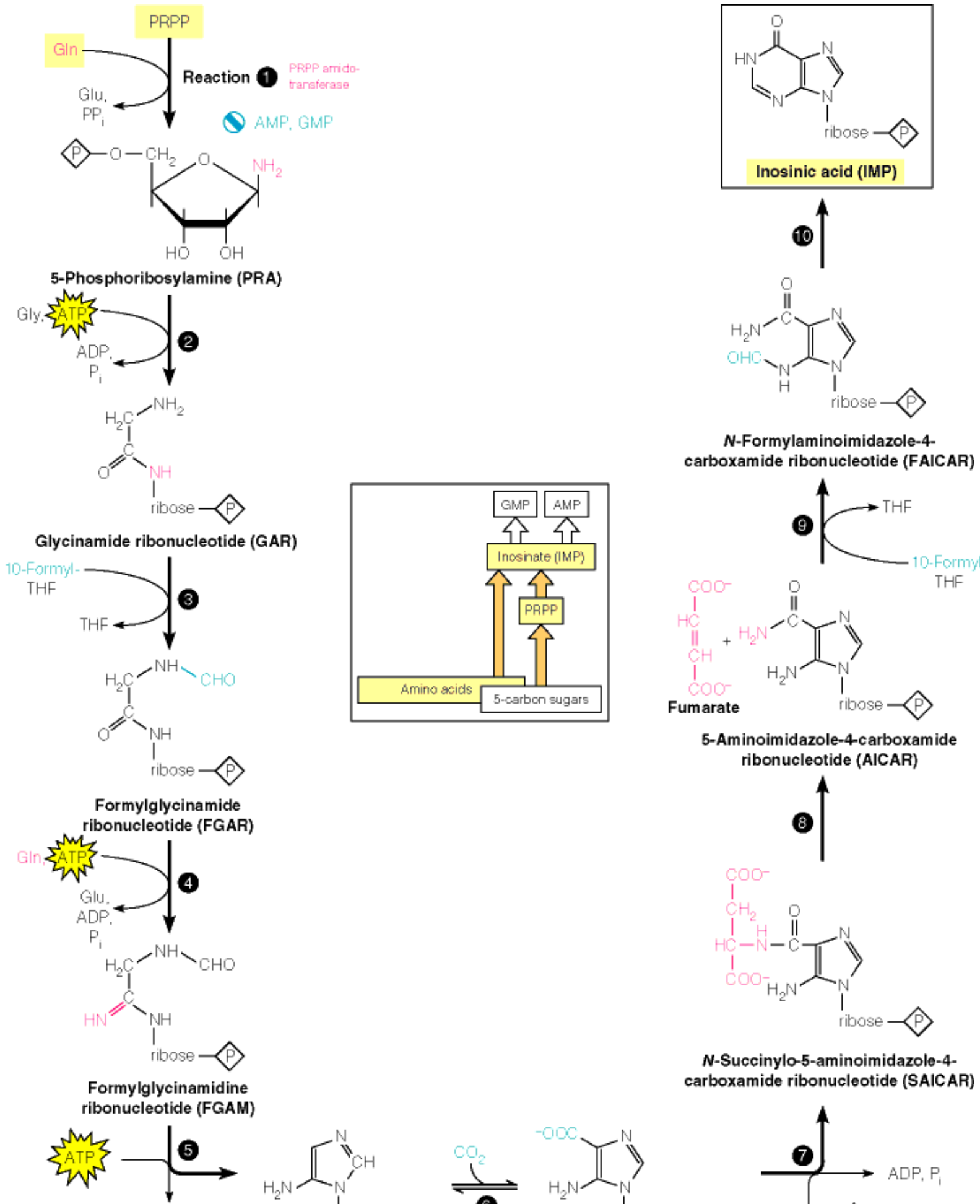

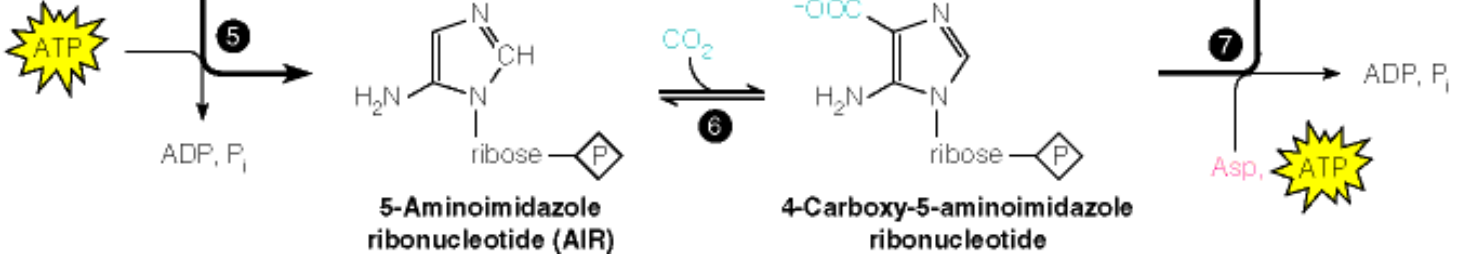

Phosphoribosyl Pyrophosphate (PRPP)

PRPP is an intermediate in nucleotide metabolism. It is found in several *de novo* and salvage pathways. **PRPP** is formed by action of the enzyme, **PRPP Synthetase**, as follows:

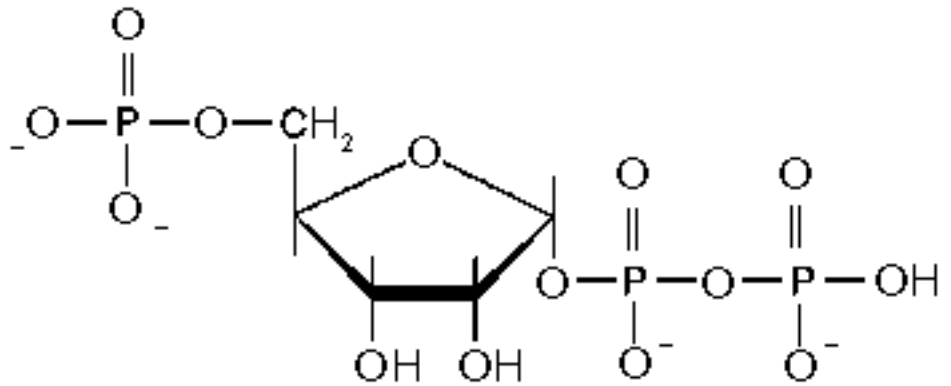

PRPP

Enzymes that act on **PRPP** include **Phosphoribosyltransferases** (salvage synthesis and *de novo* synthesis of pyrimidines), **PRPP amidotransferase** (*de novo* purine synthesis)

See also: [De Novo Biosynthesis of Purine Nucleotides](#), [De Novo Pyrimidine Nucleotide Metabolism](#), [Nucleotide Salvage Synthesis](#)

Phosphoribosyl Pyrophosphate Synthetase (PRPP Synthetase)

PRPP synthetase is an enzyme that catalyzes the reaction below (see [here](#) also):



PRPP is an important intermediate in the *de novo* synthesis of purines pathway ([Figure 22.4](#)). Defects in PRPP synthetase may render it insensitive to feedback inhibition by purine nucleotides. Thus, purine nucleotides are overproduced, leading to excessive [uric acid](#) synthesis and gout ([Figure 22.9](#)).

See also: [The Importance of PRPP](#), [De Novo Biosynthesis of Purine Nucleotides](#), [Excessive Uric Acid in Purine Degradation](#)

Unnumbered Item

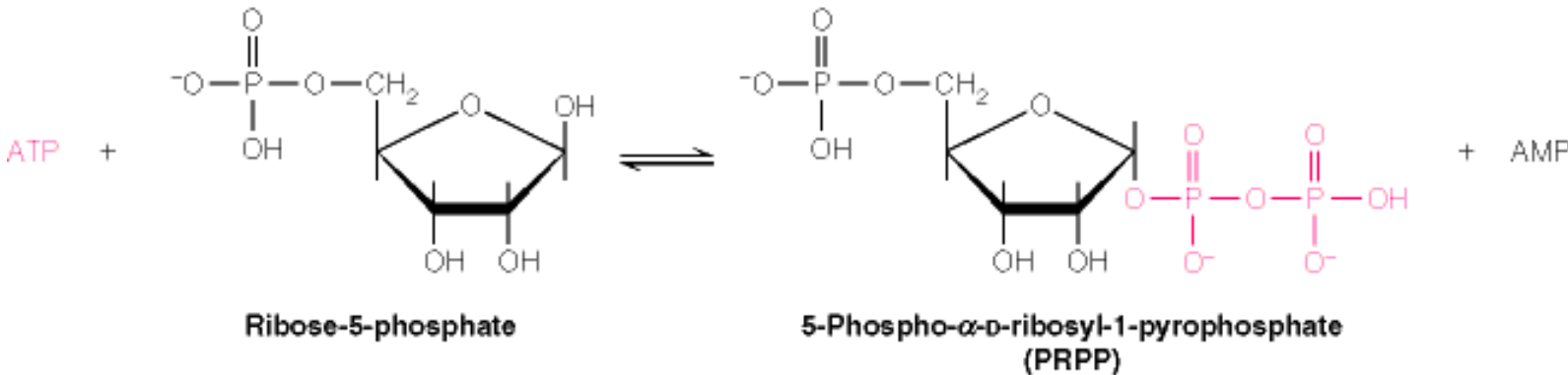

Adenosine Triphosphate (ATP)

ATP serves as the general "free energy currency" for virtually all cellular processes. Hydrolysis of **ATP** is used to drive countless biochemical reactions, including many that are not phosphorylations. It is a direct source of energy for cell motility, muscle contraction, and the

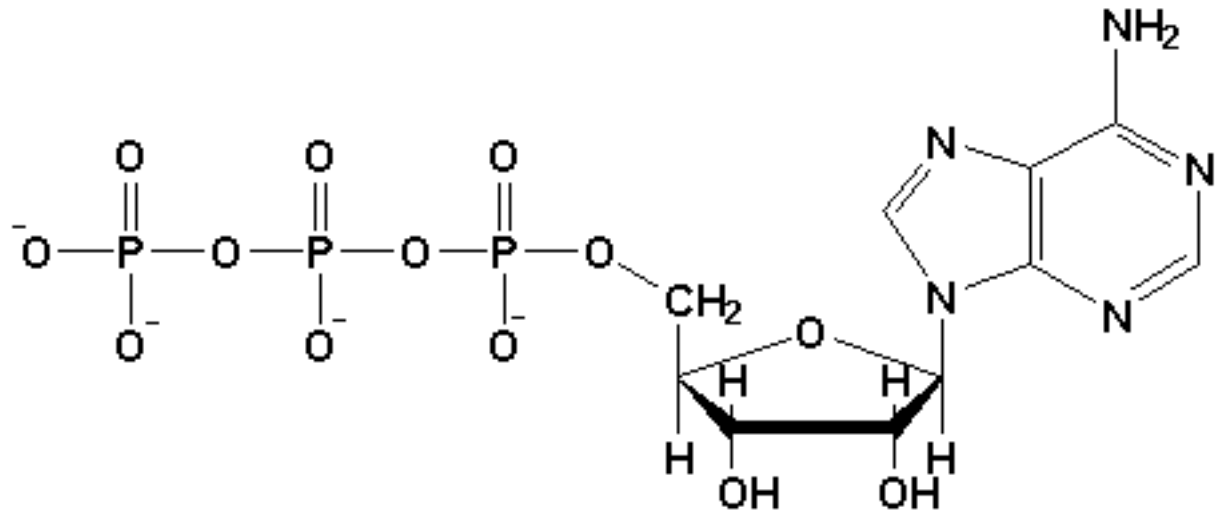

Adenosine triphosphate (ATP)

specific transport of substances across membranes. The processes of photosynthesis and metabolism of nutrients are used mainly to produce **ATP**. It is probably no exaggeration to call **ATP** the single most important substance in biochemistry. The average adult human generates enough metabolic energy to synthesize his or her own weight in **ATP** every day.

ATP is produced in the cell from **ADP** as a result of three types of phosphorylations - substrate-level phosphorylations, oxidative phosphorylation, and, in plants, photosynthetic phosphorylation.

ATP is a source of phosphate energy for synthesis of the other nucleoside triphosphates via the reaction that follows:



ATP is also an allosteric effector of many enzymes.

See also: [Nucleotides](#), [ATP as Free Energy Currency](#) (from Chapter 12), [ADP](#), [AMP](#), [Figure 3.7](#)

Adenosine Diphosphate (ADP)

ADP is a nucleotide produced as a result of hydrolysis of ATP in the most common energy-yielding reaction of cells.

ADP participates in substrate-level phosphorylation, oxidative phosphorylation, and photosynthetic phosphorylation. It is not possible to list here all of the enzymes interacting with **ADP**. Metabolism of **ADP** is shown below:

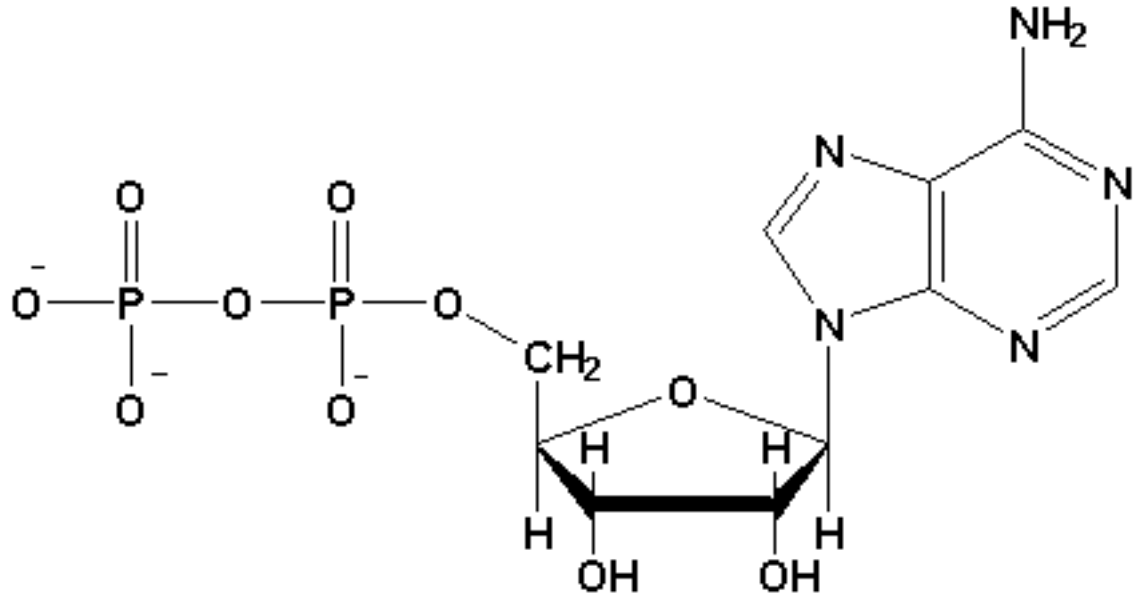

Adenosine diphosphate (ADP)

1. **ADP** \rightleftharpoons **ATP** + **AMP** (catalyzed by **adenylate kinase**).
2. **GMP** + **ATP** \rightleftharpoons **GDP** + **ADP** (catalyzed by **guanylate kinase**).
3. **NDP** + **ATP** \rightleftharpoons **NTP** + **ADP** (catalyzed by **nucleoside diphosphokinase**).
4. **ADP** + NADPH \rightleftharpoons dADP + NADP⁺ (catalyzed by **ribonucleotide reductase**).

ADP is transferred into the mitochondrial matrix by adenine nucleotide translocase and may be a limiting reagent in **oxidative phosphorylation**.

See also: **Phosphorylations**, **AMP**, **ATP**

Adenosine Monophosphate (AMP)

AMP is a common intermediate in metabolism involving ATP.

AMP is produced as a result of energy-yielding metabolism of ATP in three ways:

A. By hydrolysis of a pyrophosphate from ATP (one example is shown in reaction 1 below).

B. By transfer of a phosphate from ADP (reaction 2 below).

C. By transfer of a pyrophosphate from ATP to another metabolite (reaction 6 below)

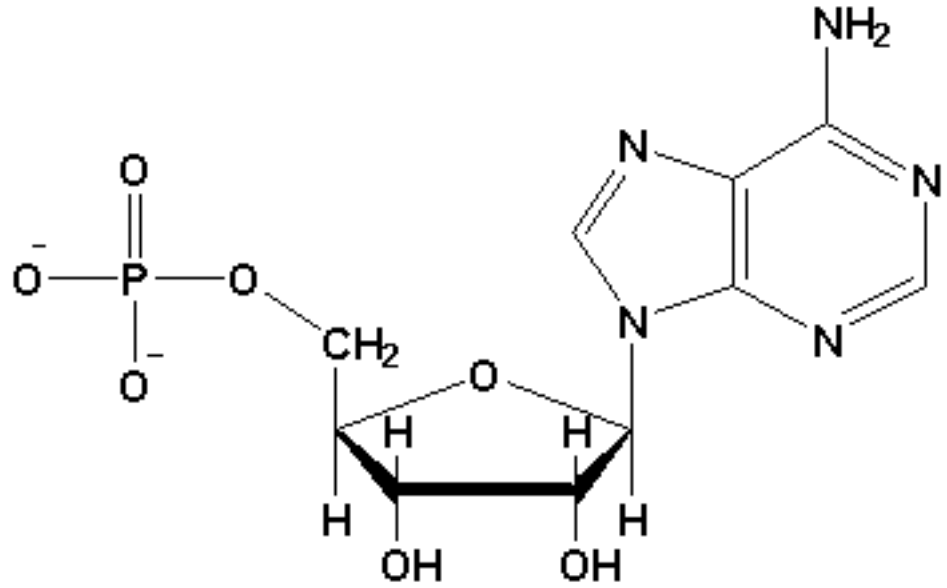

Adenosine 5'-Monophosphate

AMP is also an intermediate in *de novo* synthesis of ATP (reaction 3 below) and salvage synthesis of ATP (reactions 4, 5, and 8 below). AMP is an allosteric activator of glycogen phosphorylase b, and phosphofruktokinase, as well as an allosteric inhibitor of fructose-1,6-bisphosphatase and adenylosuccinate synthetase. AMP is also an allosteric inhibitor of glutamine synthetase, an enzyme with a central role in nitrogen metabolism in the cell.

Selected reactions involving AMP

1. Fatty acid + ATP + CoASH \rightleftharpoons Fatty acyl-CoA + AMP + P_i (catalyzed by Fatty acyl-CoA Ligase).
2. 2 ADP \rightleftharpoons ATP + AMP (catalyzed by Adenylate Kinase)
3. Adenylosuccinate \rightleftharpoons Fumarate + AMP (catalyzed by Adenylosuccinate Lyase)
4. PRPP + Adenine \rightleftharpoons AMP + P_i (catalyzed by Phosphoribosyltransferase)
5. ATP + Ribose-5-Phosphate \rightleftharpoons PRPP + AMP (catalyzed by PRPP Synthetase)
6. AMP + H₂O \rightleftharpoons NH₄⁺ + IMP (catalyzed by AMP Deaminase)

See also: [ATP](#), [ADP](#), [cAMP](#), [AMP-Dependent Protein Kinase](#)

Glycogen Phosphorylase b

Glycogen phosphorylase b is the less active form of [glycogen phosphorylase](#). It differs from [glycogen phosphorylase a](#) in that it is not phosphorylated and that it requires [AMP](#) for activity. **Glycogen phosphorylase b** is a substrate for the enzyme [glycogen phosphorylase b kinase](#), which converts the b form to the a form by adding two phosphates. The reaction is stimulated in the presence of calcium via interaction of [calmodulin](#) with glycogen phosphorylase b kinase

Two features distinguish **glycogen phosphorylase b** from the **a** form:

1. The a form is derived from the b form by phosphorylation of the b form by the enzyme phosphorylase b kinase ([Figure 13.18](#)).
2. The b form requires AMP for allosteric activation and is thus active only when cells are at a low energy state.

See also: [Mechanism of Activating Glycogen Breakdown](#), [Kinase Cascade](#), [Glycogen Breakdown Regulation](#), [Phosphorolysis](#), [Glycogen](#), [Glucose-1-Phosphate](#), [cAMP](#)

Glycogen Phosphorylase

Glycogen phosphorylase catalyzes phosphorolysis of glycogen to glucose-1-phosphate (Figure 13.18).

Two forms of the enzyme exist. The relatively "inactive" form 'b' has no phosphate, but can be converted to the more active form 'a' by action of the enzyme glycogen phosphorylase b kinase.

Two features distinguish **glycogen phosphorylase a** from the b form:

1. The a form is derived from the b form by phosphorylation of the b form by the enzyme phosphorylase b kinase.
2. The b form requires AMP for allosteric activation and is thus active only when cells are at a low energy state.

See also: Glycogen Phosphorylase a, Glycogen Phosphorylase b, Glycogen, Kinase Cascade, Glycogen Phosphorylase b Kinase, Figure 16.11

Phosphorolysis

Phosphorolysis involves the cleavage of a bond by addition across that bond of the elements of phosphoric acid. An enzyme catalyzing a **phosphorolysis** is called a phosphorylase, to be distinguished from a phosphatase (or, more precisely, a phosphohydrolase), which catalyzes the hydrolytic cleavage (hydrolysis) of a phosphate ester bond.

Energetically speaking, the **phosphorolytic** mechanism has an advantage in mobilization of glycogen, which yields most of its monosaccharide units in the form of sugar phosphates (glucose-1-phosphate). These units can be converted to glycolytic intermediates directly, without the investment of additional ATP. By contrast, starch digestion yields glucose plus some maltose. ATP and the hexokinase reaction are necessary to initiate glycolytic breakdown of these sugars.

See also: [Figure 13.15](#), [Glycogen](#), [Glucose-1-Phosphate](#), [Starch](#), [Glucose](#), [Maltose](#), [Hexokinase](#)

Figure 13.15: Cleavage of a glycosidic bond by hydrolysis or phosphorolysis.

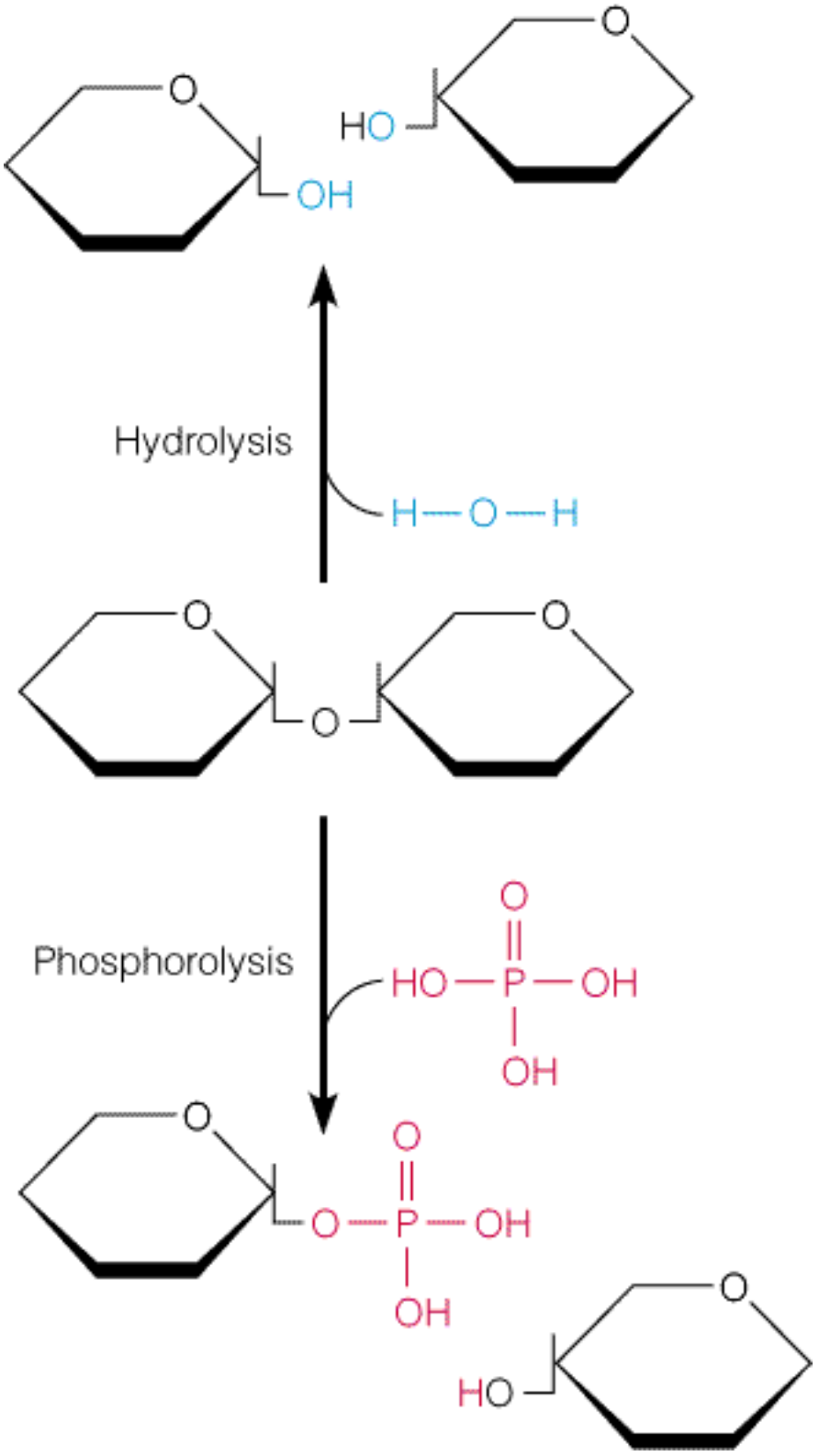

Glycogen

Glycogen is a branched polymer of [glucose](#), consisting of main branches of glucose units joined in $\alpha(1\text{-} >4)$ linkages. Every 7-20 residues, $\alpha(1\text{-} >6)$ branches of glucose units are also present. **Glycogen** is a primary energy storage material in muscle. Individual glucose units are cleaved from glycogen in a phosphorolytic mechanism catalyzed by [glycogen phosphorylase](#).

The storage polysaccharides, such as **glycogen**, are admirably designed to serve their function. Glucose and even [maltose](#) are small, rapidly diffusing molecules, which are difficult to store. Were such small molecules present in large quantities in a cell, they would give rise to a very large cell osmotic pressure, which would be deleterious in most cases. Therefore, most cells build the glucose into long polymers, so that large quantities can be stored in a semi-insoluble state. Whenever glucose is needed, it can be obtained by selective degradation of the polymers by specific enzymes.

See also: [Phosphorolysis](#), [Glycogen phosphorylase](#), [Figure 13.18](#), [Kinase Cascade](#), [Figure 13.16](#), [Figure 13.17](#), [Polysaccharides](#), [Glycogen Breakdown](#), [Hydrolysis vs Phosphorolysis](#), [Glycogen Breakdown Regulation](#)

α -D-Glucose

Glucose is a six carbon sugar which can provide a rapid source of **ATP** energy via **glycolysis**. **Glucose** is stored in polymer form by plants (starch) and animals (glycogen). Plants also have cellulose, which is not used to store **glucose**, but rather provides structural integrity to the cells.

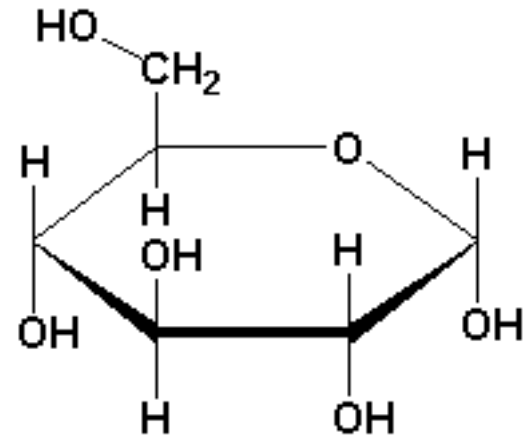

Glucose

Glucose has an anomeric carbon, which can exist in the α and β configurations. **Glucose** can exist in both the D and L forms (though the D-form predominates biologically). It can exist as a straight chain or in ring structures composed of 5 (furanose) or 6 (pyranose) member rings.

Metabolic pathways involving glucose

Glycolysis

Gluconeogenesis

Glycogen Synthesis

Glycogen Breakdown

Cori Cycle

Glycoside Formation

Other Saccharide Synthesis

See also: Diastereomers (from Chapter 9), Saccharides (from Chapter 9)

Glycolysis

Glycolysis is a central metabolic pathway involving metabolism of the sugar [glucose](#). [Figure 13.3](#) shows an overview of the process, being divided into a phase in which [ATP](#) energy is invested (see [here](#)) and a phase in which ATP energy is generated (see [here](#)). The starting point for **glycolysis** is the molecule glucose and the process ends with formation of two pyruvate molecules. Additional products of **glycolysis** include two ATPs and two [NADHs](#).

See also: [Glycolysis Reaction Summaries](#), [Molecular Intermediates](#), [Glycolysis/Gluconeogenesis Regulation](#), [Gluconeogenesis](#), [Aerobic vs Anaerobic Glycolysis](#), [Pyruvate](#)

INTERNET LINKS:

1. [Glycolysis/Gluconeogenesis](#)
-

Figure 13.3: An overview of glycolysis.

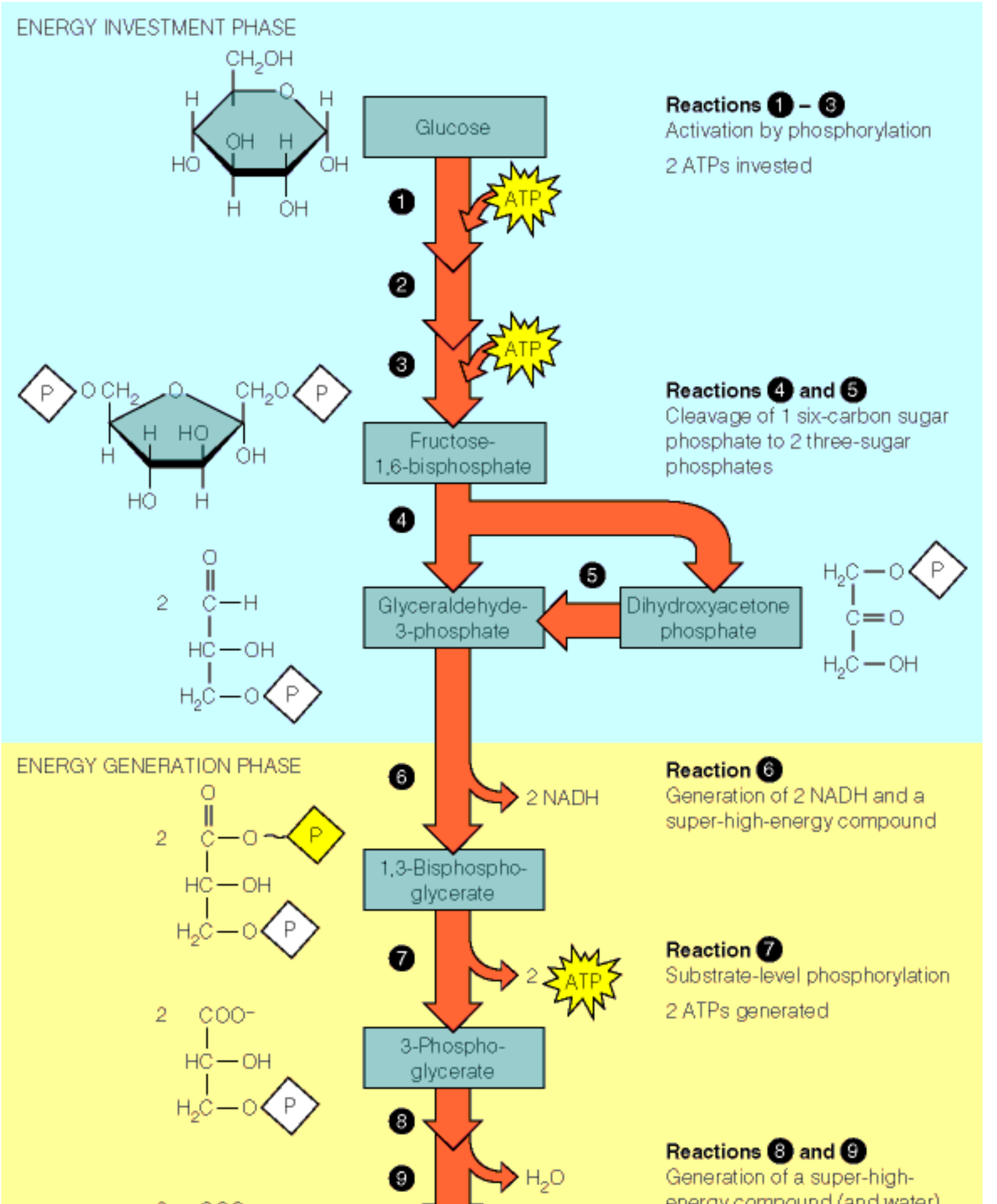

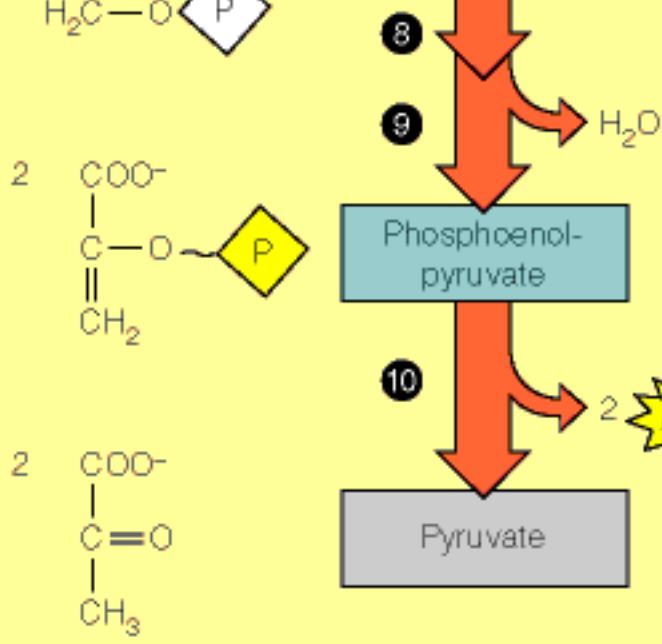

Reactions 8 and 9
 Generation of a super-high-energy compound (and water)

Reaction 10
 Substrate-level phosphorylation
 2 ATPs generated

Unnumbered Item

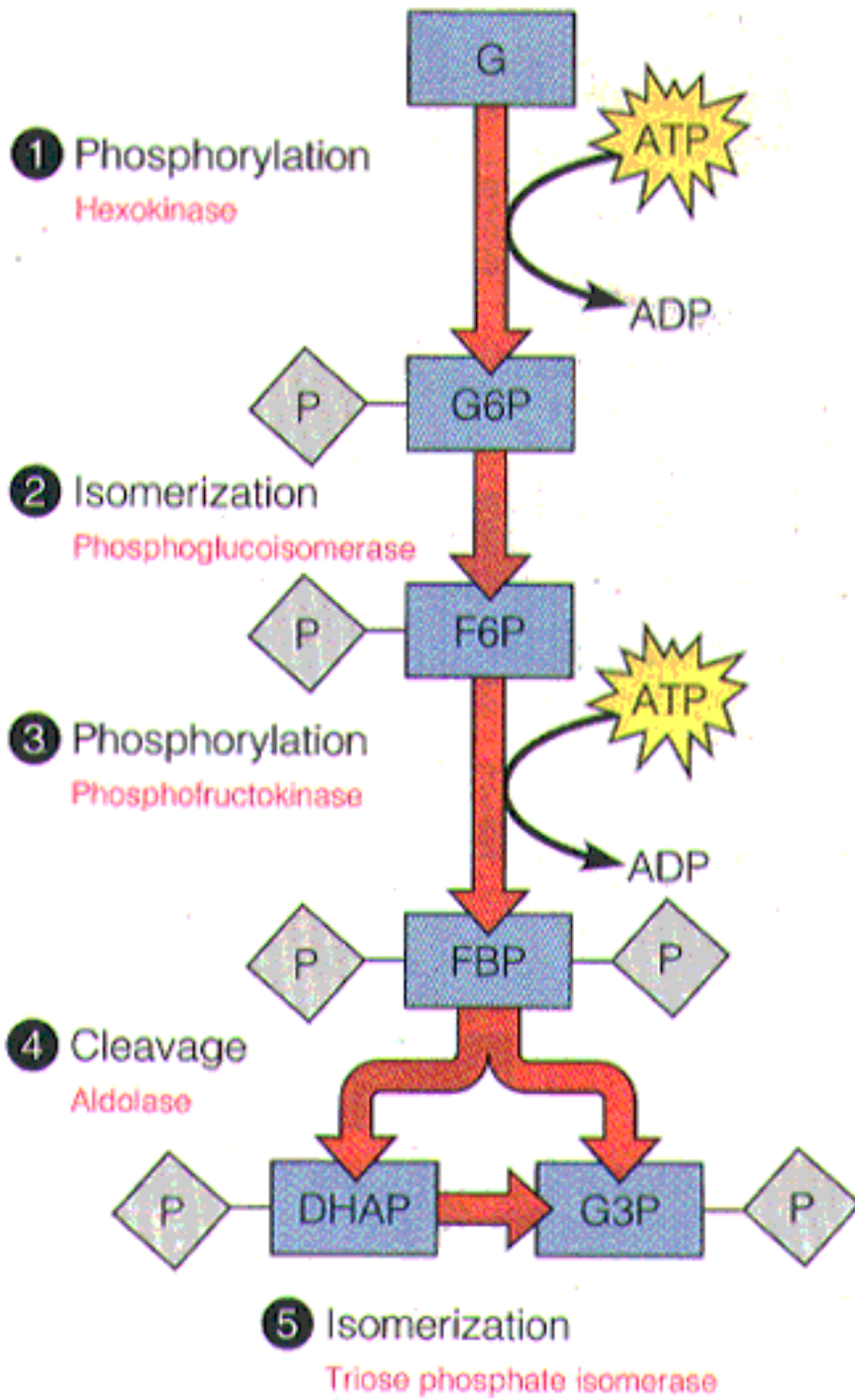

Unnumbered Item

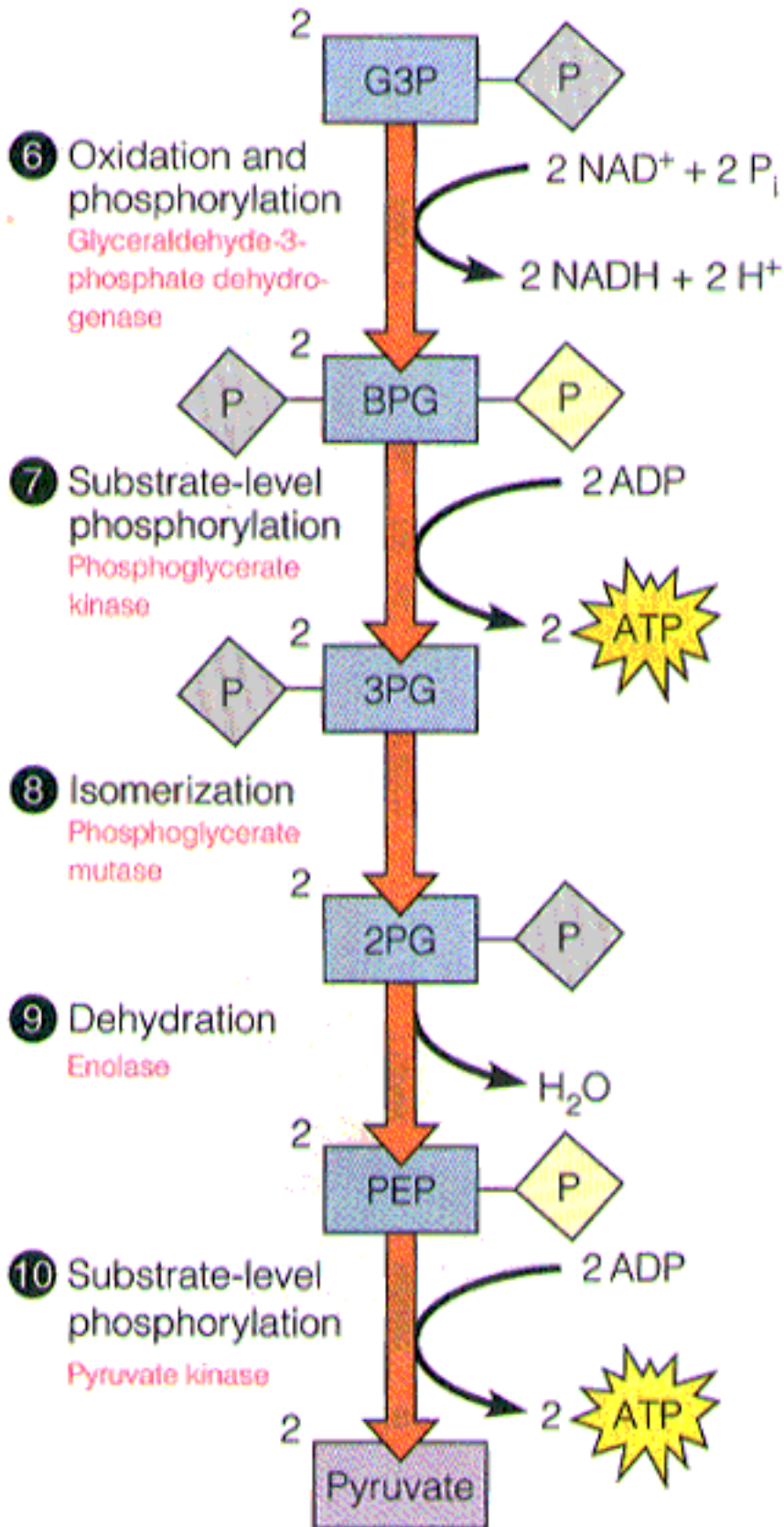

NADH

NADH is a carrier of electrons produced in biological oxidations. The molecule exists in two forms that vary in whether or not they are carrying electrons.

NADH is the reduced form of the molecule (carries electrons) and **NAD⁺** is the oxidized form of the molecule

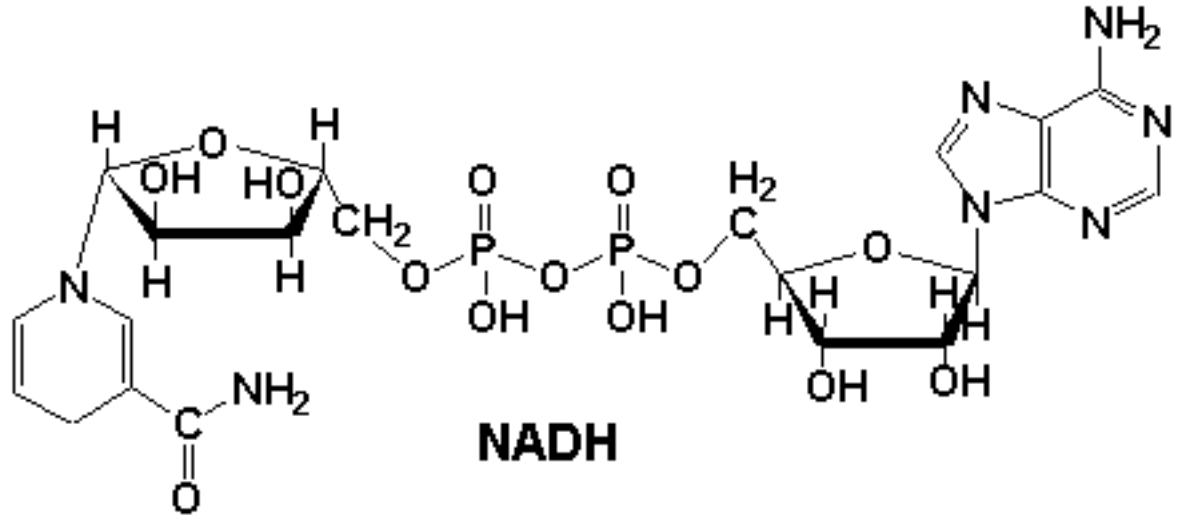

(lacks electrons). **NADH** is produced from **NAD⁺** in reactions such as conversion of **acetaldehyde** to **ethanol** by **alcohol dehydrogenase** (**Figure**). **NADH** is converted back to **NAD⁺** by donating electrons (such as in the conversion of **pyruvate** to **lactate**) or by depositing electrons into the **electron transport** system.

NADH carries electrons to the electron transport system inside the mitochondrion via a shuttle system (**Figure 15.11**). Electrons that enter via the shuttle in **Figure 15.11a** bypass complex I of the electron transport system, whereas electrons that enter via the shuttle in **Figure 15.11b** enter at complex I.

In contrast to the reduced related compound, **NADPH**, which donates electrons primarily for biosynthetic reactions, **NADH** primarily donates electrons to the electron transport system for energy generation.

See also: **Lactic Acid Fermentation**, **Alcoholic Fermentation**

INTERNET LINK: **Nicotinate and Nicotinamide Metabolism**

NAD

NADH is a carrier of electrons produced in biological oxidations. The molecule exists in two forms that vary in whether or not they are carrying electrons. NADH is the reduced form of the molecule (carries electrons) and **NAD⁺** is the oxidized form of the molecule

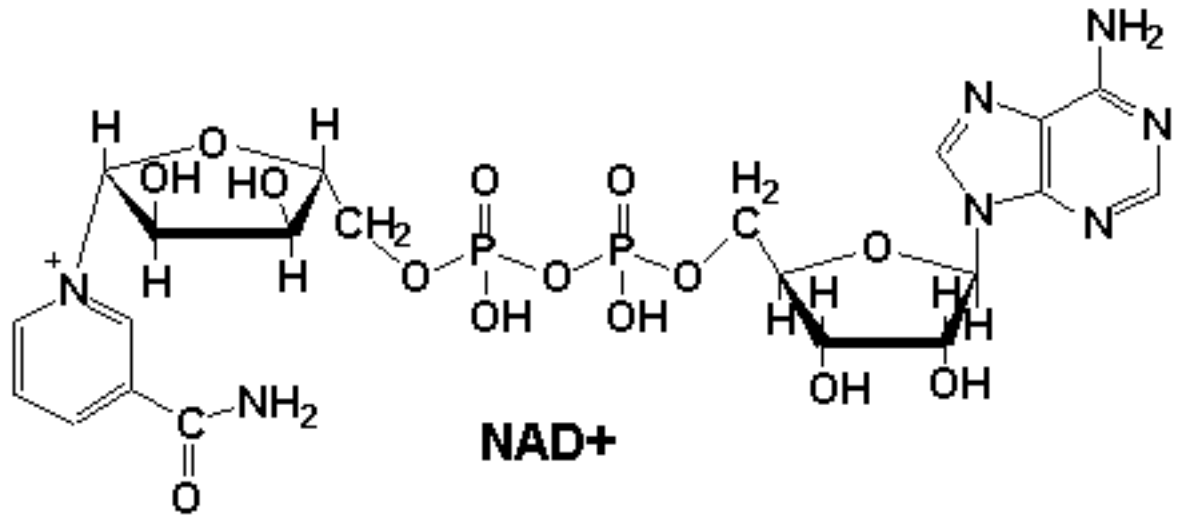

(lacks electrons). NADH is produced from **NAD⁺** in reactions such as conversion of **acetaldehyde** to **ethanol** by **alcohol dehydrogenase** (**Figure**). NADH is converted back to **NAD⁺** by donating electrons (such as in the conversion of **pyruvate** to **lactate**) or by depositing electrons into the **electron transport** system.

NADH carries electrons to the electron transport system inside the mitochondrion via a shuttle system (**Figure 15.11**). Electrons that enter via the shuttle in **Figure 15.11a** bypass complex I of the electron transport system, whereas electrons that enter via the shuttle in **Figure 15.11b** enter at complex I.

In contrast to the reduced related compound, **NADPH**, which donates electrons primarily for biosynthetic reactions, NADH primarily donates electrons to the electron transport system for energy generation.

See also: **Lactic Acid Fermentation**, **Alcoholic Fermentation**

INTERNET LINKS:

1. **3D Structure**
 2. **Nicotinate and Nicotinamide Metabolism**
-

Acetaldehyde

Acetaldehyde is a two carbon compound participating in the reactions below:

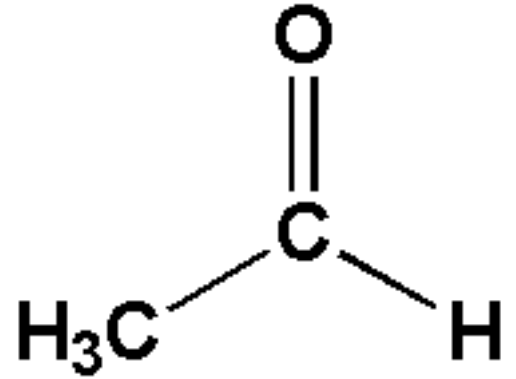

Acetaldehyde

1. **Pyruvate** \rightleftharpoons **Acetaldehyde** + CO₂ (catalyzed in yeast by **Pyruvate Decarboxylase**).
2. **Ethanol** + **NAD**⁺ \rightleftharpoons **Acetaldehyde** + **NADH** (catalyzed by **Alcohol Dehydrogenase**)
3. **Threonine** \rightleftharpoons **Acetaldehyde** + **Glycine** (catalyzed by **Threonine Aldolase**)

See also: **Alcoholic Fermentation**

Pyruvic Acid (Pyruvate)

Pyruvate is the final product of [glycolysis](#) and a starting point for [gluconeogenesis](#). Amino acids broken down through **pyruvate** include [alanine](#), [cysteine](#), [glycine](#), [serine](#), [threonine](#), and [tryptophan](#).

In [anaerobic glycolysis](#), **pyruvate** is converted to [lactate](#) or [ethanol](#)

Enzymes that act on pyruvate include:

[Pyruvate Kinase](#)

[Pyruvate Decarboxylase](#)

[Pyruvate Dehydrogenase](#)

[Pyruvate Carboxylase](#)

[Transaminases](#)

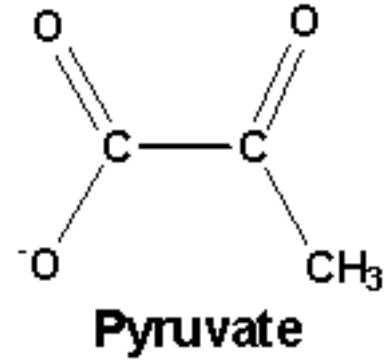

See also: [Transamination in Amino Acid Metabolism](#) (from Chapter 20), [Citric Acid Cycle Intermediates in Amino Acid Metabolism](#) (from Chapter 21)

INTERNET LINKS

[Pyruvate Metabolism](#)

Gluconeogenesis

Gluconeogenesis is a central metabolic pathway involving biosynthesis of the sugar [glucose](#). [Figure 16.6](#) shows an overview of the process. With the exception of the enzymes shown in red on the right hand side of the figure, the enzymes of **gluconeogenesis** and glycolysis are the same. One starting point for **gluconeogenesis** is two molecules of [pyruvate](#) and the process ends with formation of one glucose molecule.

See also: [Gluconeogenesis Enzymatic Reactions](#), [Gluconeogenesis Molecular Intermediates](#), [Regulation of Gluconeogenesis and Glycogen](#), [Glycolysis](#),

INTERNET LINK: [Glycolysis/Gluconeogenesis](#)

Figure 16.6: Major control mechanisms affecting glycolysis and gluconeogenesis.

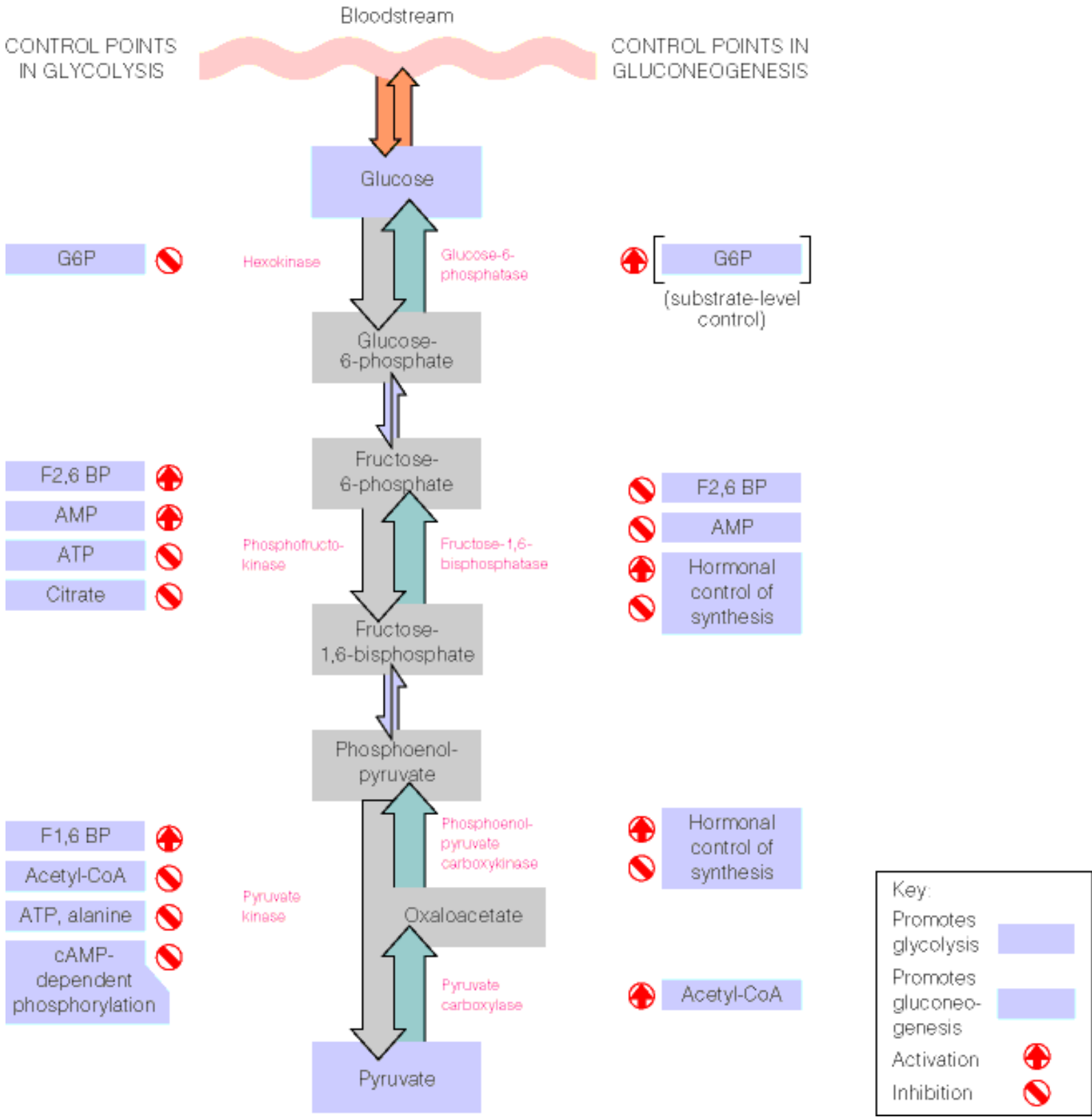

Enzymes of Gluconeogenesis

Eleven reactions are catalyzed in **gluconeogenesis**. The enzymes involved and the reactions they catalyze are listed below. Glycolysis uses many of the same enzymes as **gluconeogenesis**, but with reversal of reaction direction. Enzymes differing between glycolysis and **gluconeogenesis** are marked with an asterisk (*).

* [Glucose-6-Phosphatase](#) (glycolysis uses [Hexokinase](#))

[Phosphoglucoisomerase](#)

* [Fructose-1,6-Bisphosphatase](#)(glycolysis uses [Phosphofructokinase](#))

[Fructose-1,6-Bisphosphate Aldolase](#)

[Triosephosphate Isomerase](#)

[Glyceradehyde-3-Phosphate Dehydrogenase](#)

[Phosphoglycerate Kinase](#)

[Phosphoglycerate Mutase](#)

[Enolase](#)

* [PEPCK](#) (Glycolysis uses [Pyruvate Kinase](#))

[Pyruvate Carboxylase](#) (Glycolysis uses [Pyruvate Kinase](#))

See also: [Glycolysis/Gluconeogenesis Regulation](#), [Enzymes/Energies of Glycolysis](#),
[Gluconeogenesis](#), [Glycolysis](#)

Glucose-6-Phosphatase

Glucose-6-phosphatase is an enzyme of [gluconeogenesis](#) that catalyzes the hydrolysis of glucose-6-phosphate (G6P) to glucose plus Pi.

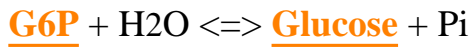

Activity of the enzyme is regulated, not allosterically, but rather by the concentration of the substrate, G6P. Normally the concentration of G6P is considerably lower than the K_M of the enzyme.

Glucose-6-phosphatase is an important enzyme for making glucose from G6P in tissues, such as liver and kidney, that supply glucose to other tissues via the bloodstream. The enzyme is not made appreciably in muscles, which obtain glucose for use in glycolysis either from the bloodstream or as G6P from glucose-1-phosphate produced during glycogen catabolism. The enzyme has been implicated in von Gierke's disease, a glycogen storage disorder (see [here](#)).

See also: [Glycolysis/Gluconeogenesis Regulation Links](#), [Enzymes of Gluconeogenesis](#); [Enzymes/Energies of Glycolysis](#), [Hexokinase](#), , [Glycolysis](#), [Glucose-1-Phosphate](#), [Muscle Metabolism](#)

INTERNET LINK: [Glycolysis/Gluconeogenesis](#)

α -D-Glucose-6-Phosphate (G6P)

G6P is a phosphorylated form of [glucose](#) commonly found in cells. **G6P** is an intermediate in [glycolysis](#), [gluconeogenesis](#), the [pentose phosphate pathway](#), the [Calvin Cycle](#), [glycogen biosynthesis](#), [glycogen breakdown](#), and sugar interconversion. The latter three pathways indirectly involve **G6P** via the enzyme phosphoglucomutase.

Enzymes whose activity includes **G6P**:

[Glucokinase](#)

[Hexokinase](#)

[Phosphoglucoisomerase](#)

[Phosphoglucomutase](#)

[Glucose-6-Phosphate Dehydrogenase](#)

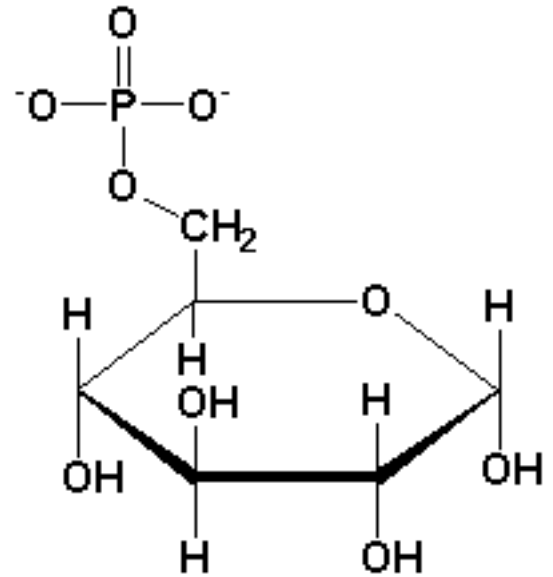

Glucose-6-Phosphate (G6P)

See also: [Phosphoglucomutase](#), [Liver Metabolism](#), [Glycogen Metabolism Diseases](#)

INTERNET LINK: [Pentose Phosphate Pathway](#)

Pentose Phosphate Pathway

The **pentose phosphate pathway** is an important pathway for generating NADPH (for biosynthetic reactions) and pentose sugars (for nucleotide biosynthesis). It operates exclusively in the cytosol. Be aware that in contrast to pathways, such as glycolysis (with a linear sequence of reactions) or the citric acid cycle (with a circular sequence of reactions), the **pentose phosphate pathway** has several possible "branches" that can be taken to allow it to supply the cell with different products as needed. The primary products of the pathway include NADPH (from the oxidative reactions), pentoses (used in nucleotide synthesis), and miscellaneous other sugar phosphates.

A variation of the **pentose phosphate pathway** called the **Calvin cycle** is used by plants to fix CO₂ in photosynthesis.

Oxidative Phase (Generates **NADPH**)

Glucose-6-Phosphate + **NADP[±]** \rightleftharpoons **6-Phosphogluconolactone** + **NADPH** (catalyzed by **Glucose-6-Phosphate Dehydrogenase**)

6-Phosphogluconolactone + H₂O \rightleftharpoons **6-Phosphogluconate** + H⁺ (catalyzed by **Lactonase**)

6-Phosphogluconate + **NADP[±]** \rightleftharpoons **Ribulose-5-Phosphate** + CO₂ + **NADPH** (catalyzed by **6-Phosphogluconate Dehydrogenase**)

Nonoxidative Phase (note how products of each reaction are shuffled - the pathway does not lead to a single end product)

Ribulose-5-Phosphate \rightleftharpoons **Ribose-5-Phosphate** (catalyzed by **Phosphopentose Isomerase**)

Ribulose-5-Phosphate \rightleftharpoons **Xylulose-5-Phosphate** (catalyzed by **Phosphopentose epimerase**)

Xylulose-5-Phosphate + **Ribose-5-phosphate** \rightleftharpoons **Glyceraldehyde-3-phosphate** + **Sedoheptulose-7-Phosphate** (catalyzed by **Transketolase**)

Sedoheptulose-7-Phosphate + **Glyceraldehyde-3-Phosphate** \rightleftharpoons **Erythrose-4-**

Phosphate + Fructose-6-Phosphate (catalyzed by Transaldolase)

Xylulose-5-phosphate + Erythrose-4-Phosphate \rightleftharpoons Glyceraldehyde-3-phosphate +
Fructose-6-phosphate (catalyzed by Transketolase)

See also: Enzymes of the Pentose Phosphate Pathway, Intermediates of the Pentose Phosphate Pathway,

INTERNET LINK: Pentose Phosphate Pathway

Calvin Cycle

The **Calvin cycle**-the so-called dark reactions of photosynthesis-does not occur solely in the dark. In fact, the dark reactions are stimulated by light, but do not directly use the energy of light to function. Instead, they use the NADPH and ATP generated by the light reactions to fix atmospheric carbon dioxide into carbohydrates.

The dark reactions occur in the stroma of the chloroplast and are shown schematically in [Figure 17.20](#). The cycle can be viewed as occurring in two stages. In stage I, carbon dioxide is trapped as a carboxylate and reduced to the aldehyde-ketone level found in sugars. In stage II, the molecule that accepts CO₂ is regenerated. Note with each turn of the cycle in [Figure 17.20](#) that one glyceraldehyde-3-phosphate exits the cycle to be made into hexose phosphates (such as glucose-6-phosphate) and other sugar moieties. Thus, the end products of the **Calvin cycle** are hexoses and a regenerated acceptor molecule.

Stage 1: The initial reaction, in which CO₂ is first incorporated into [ribulose-1,5-bisphosphate](#) (RuBP), is shown [here](#). This reaction is catalyzed by the enzyme ribulose-1,5-bisphosphate carboxylase, more commonly known as [rubisco](#). The end product of this reaction is two molecules of [3-phosphoglycerate](#), a [gluconeogenesis](#) and [glycolysis](#) intermediate.

Next, 3-phosphoglycerate is converted to [1,3 bisphosphoglycerate](#) (BPG) and then to [glyceraldehyde-3-phosphate](#) (G3P) by the enzymes [phosphoglycerate kinase](#) and [glyceradehyde-3-phosphate dehydrogenase](#), respectively. These two reactions are similar to the analogous ones that occur in gluconeogenesis.

To this point, one molecule of CO₂ has been incorporated and two G3Ps have been made at the expense of 2 [ATPs](#) and 2 [NADPHs](#) from the light reactions. Because it takes 6 CO₂ to make one complete glucose molecule, it takes 12 ATP and 12 NADPH to incorporate a complete glucose from CO₂. Six CO₂ molecules will also generate 12 G3Ps at this point ([Figure 17.21](#)). Two of these are used to make one glucose-phosphate compound (via gluconeogenesis) and the other 10 are used to regenerate the 6 molecules of RuBP that are necessary to bind to 6 CO₂ molecules. Of the 10 G3Ps involved in regeneration of RuBP, 4 go through part of the gluconeogenesis cycle and form 2 molecules of [fructose-6-phosphate](#) (F6P).

Stage II: Many of the reactions of the **Calvin cycle** also occur in the [pentose phosphate pathway](#). The two F6P molecules from the last step of stage I react with the remaining 6 G3Ps as shown in [Figure 17.22](#). Two of the G3Ps are isomerized to dihydroxyacetone

phosphate ([DHAP](#)). As shown in [Figure 17.22](#), the enzymes [transketolase](#), [aldolase](#), [phosphatase](#), and transketolase (again) generate intermediates after combining the G3Ps and DHAPs together. These intermediates include 4-[xylulose-5-phosphates](#) and 2 [ribulose-5-phosphates](#). Conversion of the 4 xylulose-5-phosphates to 4 ribulose-5-phosphates occurs and the 6 ribulose-5-phosphates are phosphorylated by kinases to regenerate the 6 RuBPs. This last reaction requires 1 ATP per molecule converted, or a total of 6 ATPs. The overall equation for the **Calvin cycle** is shown in [here](#). Note that complete synthesis of one molecule of glucose requires 18 ATPs and 12 NADPHs.

See also: [Calvin Cycle Reactions](#), [C4 Cycle](#), [Basic Processes of Photosynthesis](#), [Relationship of Gluconeogenesis to Glycolysis](#) (from Chapter 16), [Pentose Phosphate Pathway](#) (from Chapter 14)

INTERNET LINKS:

1. [CO2 Fixation in Bacteria](#)
 2. [CO2 Fixation in Plants](#)
-

Figure 17.20: Schematic view of the Calvin cycle.

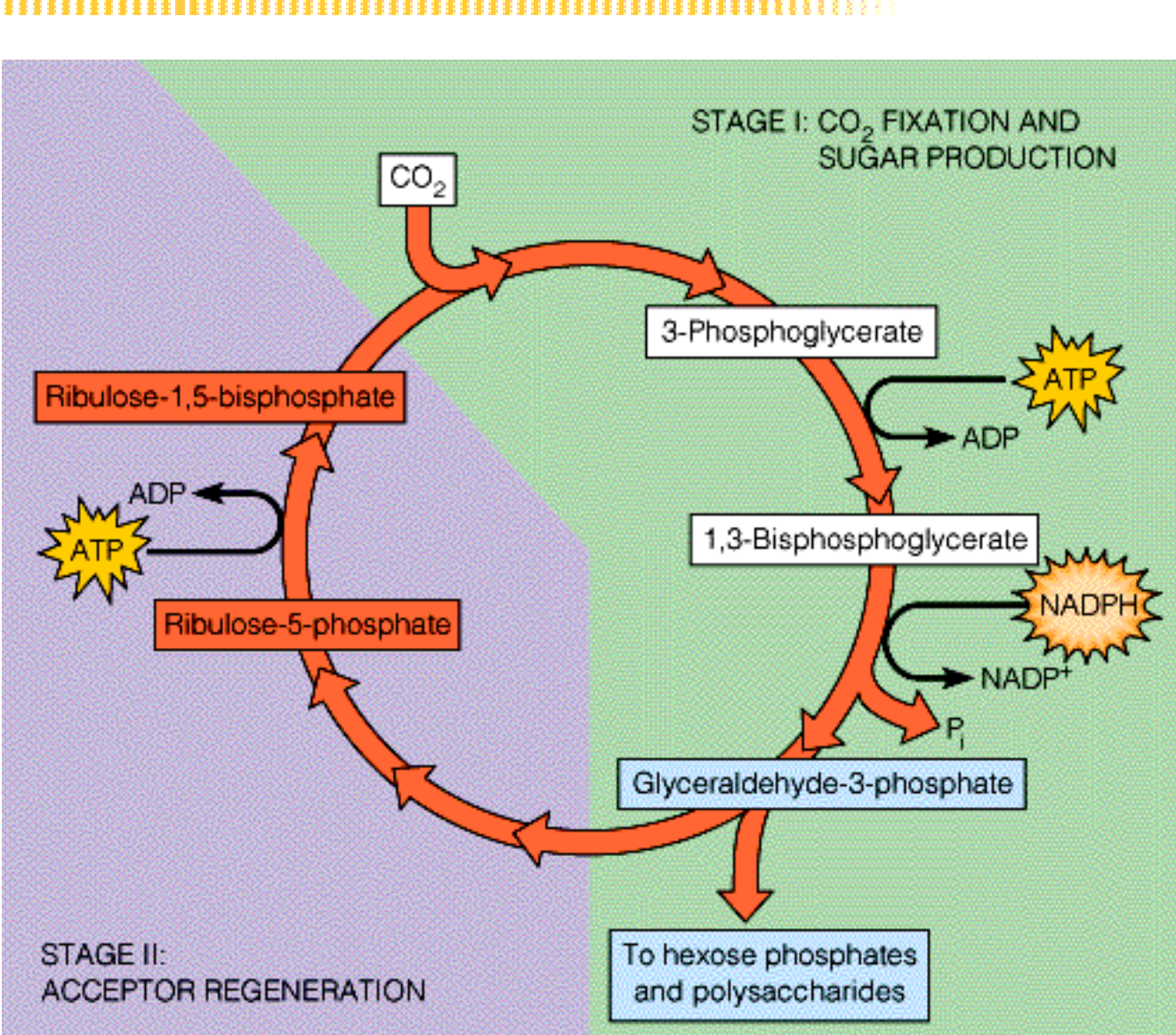

Ribulose-1,5-Bisphosphate (RuBP)

RuBP is the intermediate of the Calvin cycle onto which CO₂ is added in the process of carbon dioxide fixation. The reaction below is catalyzed by the enzyme called **rubisco**

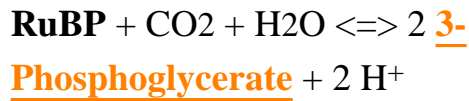

RuBP is made by action of a **kinase** acting on ribulose-5-phosphate, as follows:

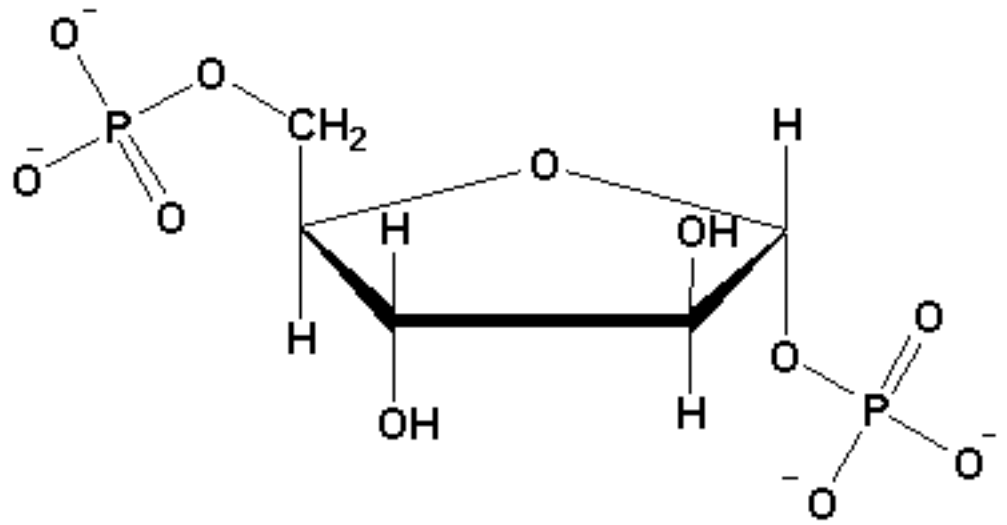

Ribulose-1,5-bisphosphate (RuBP)

See also: [Calvin Cycle](#), [Rubisco](#), [Photorespiration](#)

Ribulose Bisphosphate Carboxylase-Oxygenase (RUBISCO)

Rubisco is the probably the most abundant protein on the planet Earth. It contains two important activities.

1. Rubisco is the enzyme catalyzing the following reaction:

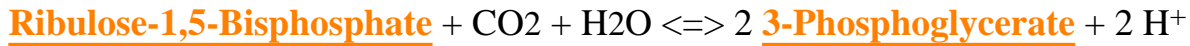

The reaction above is the first step of the Calvin cycle and is responsible for a vast amount of the carbon dioxide fixation that occurs as a result of photosynthesis. The enzyme also has an unusual oxygenase activity, shown below:



Phosphoglycolate is subsequently dephosphorylated and passed into organelles called the peroxisomes where it is further oxidized, the **glyoxylate** is amidated, and **glycine** is produced. This process is referred to as photorespiration and it occurs under conditions where the oxygen concentration is high. The C₄ cycle, which occurs in so-called C₄ plants, bypasses some of the inefficiency of photosynthesis arising from photorespiration.

See also: [Calvin Cycle](#), [Photorespiration](#), [The C₄ Cycle](#)

3-Phosphoglycerate

3-Phosphoglycerate is an intermediate in the [glycolysis](#), [gluconeogenesis](#), and [Calvin cycle](#) pathways and in metabolism of [serine](#), [cysteine](#), and [glycine](#). **3-Phosphoglycerate** is acted on by the glycolytic enzymes [phosphoglycerate kinase](#) and [phosphoglycerate mutase](#) and the important photosynthesis enzyme, ribulose-1,5-bisphosphate carboxylase ([rubisco](#)).

See also: [2,3-Bisphosphoglycerate](#), [2-Phosphoglycerate](#)

INTERNET LINK: [Glycolysis/Gluconeogenesis](#)

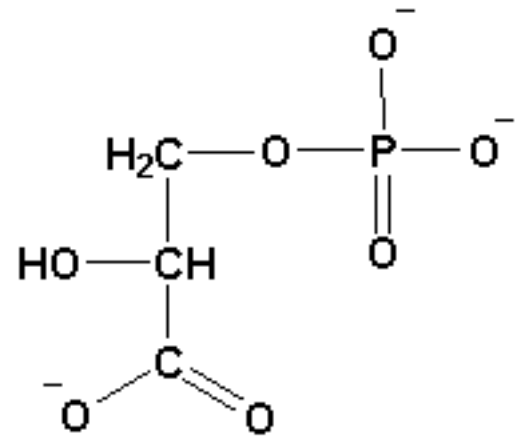

3-phosphoglycerate

Unnumbered Item

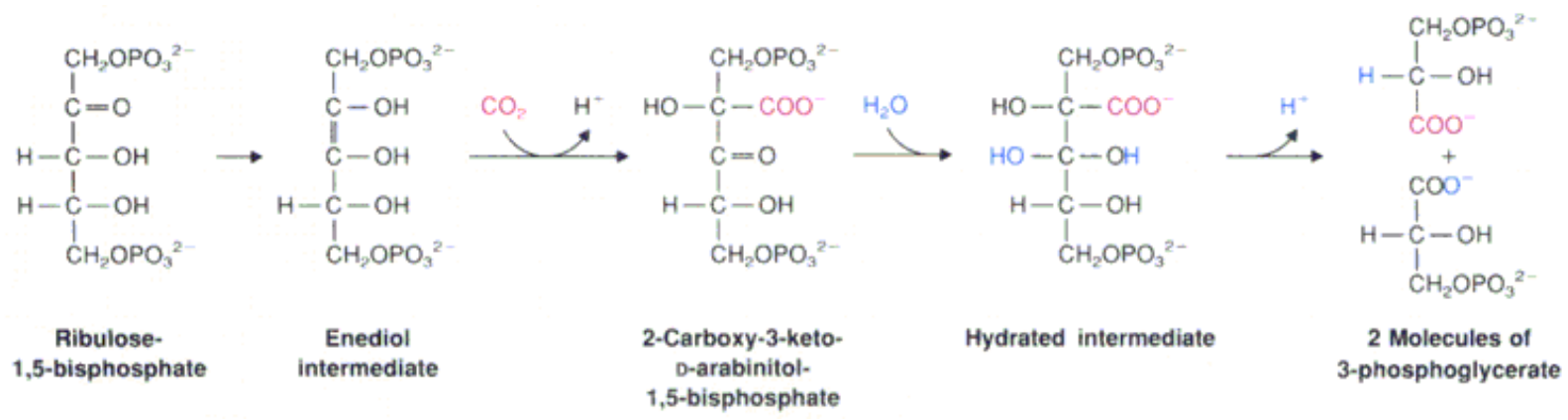

Serine

Serine is an α **amino acid** found in proteins. In mammals, **serine** is a non-essential amino acid, meaning it does not need to be present in the diet.

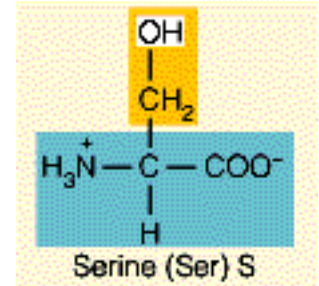

Serine's alcohol chain is a site of phosphorylation of many proteins.

The hydroxy and sulfur-containing amino acids are generally more hydrophilic than their aliphatic analogs.

One Letter Code	Three Letter Code	Molecular Wt. (Daltons)	Genetic Code Codons
S	SER	87.08	UCU, UCC, UCA, UCG, AGU, AGC

See also: [Table 5.1, Genetic Code](#), [Metabolism of Serine, Glycine, and Threonine](#), [Figure 21.24](#), [Figure 21.25](#), [Essential Amino Acids](#)

INTERNET LINK: [Gly, Ser, Thr Metabolism](#)

Amino Acid Information

1. **L-Amino acids** are the building blocks of proteins. They are frequently grouped according to the chemical nature of their side chains. Common groupings of amino acids are [aliphatic](#), [hydroxyl/sulfur](#), [cyclic](#), [aromatic](#), [basic](#), [acidic and acid amides](#). Links to individual **amino acids** are given below:

Alanine	Arginine	Asparagine	Aspartic Acid
Cysteine	Glutamine	Glutamic Acid	Glycine
Histidine	Isoleucine	Leucine	Lysine
Methionine	Phenylalanine	Proline	Serine
Threonine	Tryptophan	Tyrosine	Valine

A rare amino acid, [selenocysteine](#), is sometimes incorporated into proteins at UGA, which is normally a normal [stop codon](#).

2. [Figure 5.3](#) shows the structures of the 20 **amino acids** in proteins. [Table 5.1](#) lists the 20 amino acids used to make proteins, the one-letter code used to designate them, and some of their chemical properties.

2. The genetic code for each of the 20 **amino acids** above is shown [here](#). Links and 1/3 letter codes are shown [here](#).

3. **Amino acids** not found in proteins are shown [here](#).

4. [Modified amino acids](#) are sometimes found in proteins.

5. Virtually all **amino acids** in proteins are in the L configuration.

6. During times of starvation or low food supply, some **amino acids** (called glucogenic) can serve as precursors of [glucose](#) via [gluconeogenesis](#).

7. Dietary **amino acids** are classified as being [essential](#) (must be in the diet) or non-essential (can be synthesized by the organism).

See also: [Amino Acids](#), [Proteins](#), [Gluconeogenesis Precursors](#), [Essential Amino Acids](#)

INTERNET LINK: [Introduction to Amino Acids](#)

>Aliphatic Amino Acids

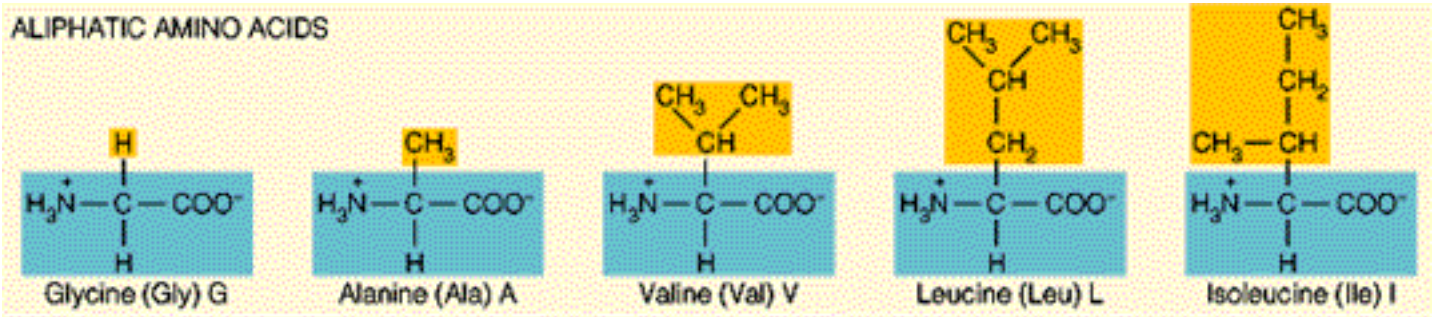

Glycine

Glycine is one of the 20 common α [amino acids](#) found in proteins. In mammals, **glycine** is a non-essential amino acid, meaning it does not need to be present in the diet.

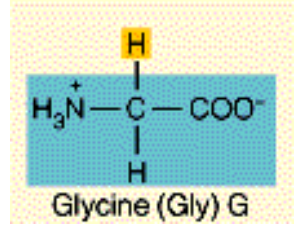

Glycine has the smallest functional group (hydrogen) of any of the α amino acids.

One Letter Code	Three Letter Code	Molecular Wt. (Daltons)	Genetic Code Codons
G	GLY	57.06	GGU, GGC, GGA, GGG

Glycine is an allosteric inhibitor of [glutamine synthetase](#), an enzyme with a central role in nitrogen metabolism in the cell.

See also - [Table 5.1, Genetic Code](#), [Glutathione](#), [Metabolism of Serine, Glycine, and Threonine](#), [Essential Amino Acids](#), [Titration Curve of Glycine](#)

INTERNET LINK: [Gly, Ser, Thr Metabolism](#)

Glutamine Synthetase

Glutamine synthetase is an important enzyme both in synthesis of glutamine and in ammonia metabolism. It catalyzes the following reaction (see [here](#) also):

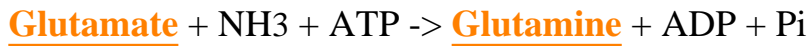

The *E. coli* **glutamine synthetase** is a dodecamer, with 12 identical subunits and the complex has a molecular weight of about 600,000 Daltons. The amide nitrogen of glutamate is used for the synthesis of several amino acids, purine and pyrimidine nucleotides, and amino sugars, so **glutamine synthetase** plays a central role in nitrogen metabolism. In animals, the enzyme is a key participant in detoxifying ammonia, particularly in the brain, and in ammonia excretion in the kidney. Accumulation of glutamate and glutamine depletes α -ketoglutarate, which would interfere with the [citric acid cycle](#). As a result, **glutamine synthetase** is tightly regulated. Mechanisms controlling the activity of **glutamine synthetase** include the following:

Cumulative feedback Inhibition - Eight specific feedback inhibitors, which are either metabolic end products of glutamine ([tryptophan](#), [histidine](#), [glucosamine-6-phosphate](#), [carbamoyl phosphate](#), [CTP](#), or [AMP](#)) or indicators of the general status of amino acid metabolism ([alanine](#) or [glycine](#)), can bind to any of the subunits of the enzyme and at least partially inhibit it. The more inhibitors that bind, the greater the inhibition.

Covalent modification (adenylation) - A specific tyrosine residue in glutamine synthetase can react with ATP to form a phosphate ester with AMP (see [here](#)). Adenylation renders the catalytic site of the enzyme inactive. Adenylation and deadenylation involve a complex series of regulatory cascades. [Figure 20.9](#) shows regulatory mechanisms of the *E. coli* enzyme. Both processes are catalyzed by the same enzyme—a complex of [adenyl transferase \(AT\)](#) and a regulatory protein, PII. The form of PII determines whether the AT-PII complex catalyzes adenylation or deadenylation. If PII is uridylylated, the AT-PII complex catalyzes deadenylation. Deuridylylation of PII causes the AT-PII complex to catalyze adenylation. The enzyme [uridylyl transferase](#) catalyzes uridylylation of PII, whereas deuridylylation is catalyzed by a different enzyme. Uridylyl transferase is allosterically regulated, with ATP and α -ketoglutarate activating it and glutamine inhibits it.

See also: [Utilization of Ammonia](#), [Transamination in Amino Acid Metabolism](#)

Unnumbered Item

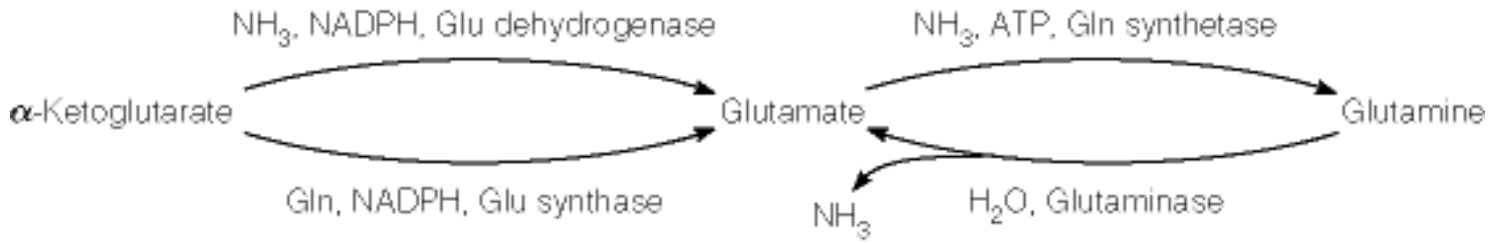

Glutamic Acid (Glutamate)

Glutamic acid (glutamate) is an α amino acid found in proteins. In mammals, **glutamic acid** is a non-essential amino acid, meaning it does not need to be present in the diet. **Glutamic acid** (surprise!) is classified as an acidic amino acid.

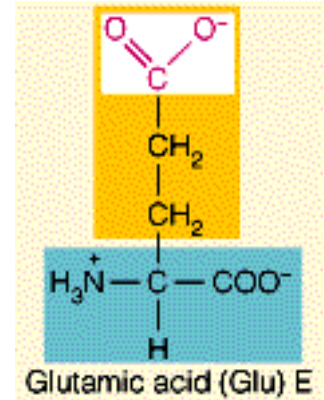

In animals, **vitamin K2** carboxylates **glutamate** residues in certain proteins, to give γ -**carboxyglutamate**. This modification allows the protein to bind calcium, an essential event in the blood clotting cascade. Carboxylation of **glutamate** residues occurs in other proteins that are active in the mobilization or transport of calcium.

Glutamic acid is very important in transamination reactions in the body and as a precursor of other amino acids.

One Letter Code	Three Letter Code	Molecular Wt. (Daltons)	Genetic Code Codons
E	GLU	129.12	GAA, GAG

Reactions involving **glutamate**:



5. UTP + ATP + Glutamine \rightleftharpoons CTP + ADP + **Glutamate** + Pi (catalyzed by CTP Synthetase)

6. Glutamate + NADP⁺ (or NAD⁺) + H₂O \rightleftharpoons α -Ketoglutarate + NADPH (or NADH) + NH₄⁺ (catalyzed by Glutamate Dehydrogenase)

See also: Table 5.1, Amino Acids, Genetic Code, γ -Carboxyglutamic Acid, Glutamine, Glutamate as a Precursor of Other Amino Acids (from Chapter 21), Transamination in Amino Acid Metabolism (from Chapter 20), Citric Acid Cycle Intermediates in Amino Acid Metabolism (from Chapter 21), Essential Amino Acids

INTERNET LINKS:

1. Glutamate Metabolism
 2. Urea Cycle and Metabolism of Amino Groups
-

Vitamin K

In animals, **vitamin K2** carboxylates **glutamate** residues in certain proteins, to give γ carboxyglutamate. This modification allows the protein to bind calcium, an essential event in the blood clotting cascade.

Carboxylation of glutamate residues occurs in other proteins that are active in the mobilization or transport of calcium.

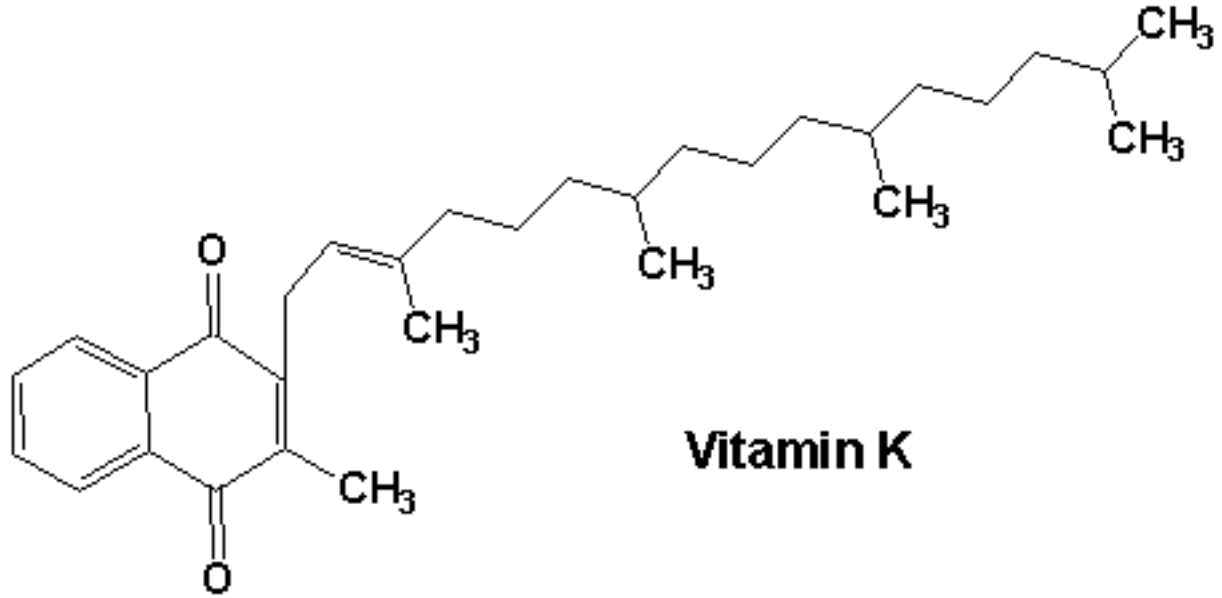

Vitamin K is found in plants as phylloquinone (**vitamin K1**) and in animals as menaquinone (**vitamin K2**). **Vitamin K2** is essential for the carboxylation of glutamate residues in certain proteins, to give γ -carboxyglutamate. This modification allows the protein to bind calcium, an essential event in the blood clotting cascade. Carboxylation of glutamate is also important in other proteins involved in the mobilization or transport of calcium.

See also: [Lipid-Soluble Vitamins](#)

INTERNET LINK: [Vitamin K](#)

Vitamin K1 (Phylloquinone)

Vitamin K is found in plants as **phylloquinone (vitamin K1)** and in animals as menaquinone (vitamin K2). Vitamin K2 is essential for the carboxylation of glutamate residues in certain proteins, to give γ -carboxyglutamate. This modification allows the protein to bind calcium, an essential event in the blood clotting cascade. Carboxylation of glutamate is also important in other proteins involved in the mobilization or transport of calcium.

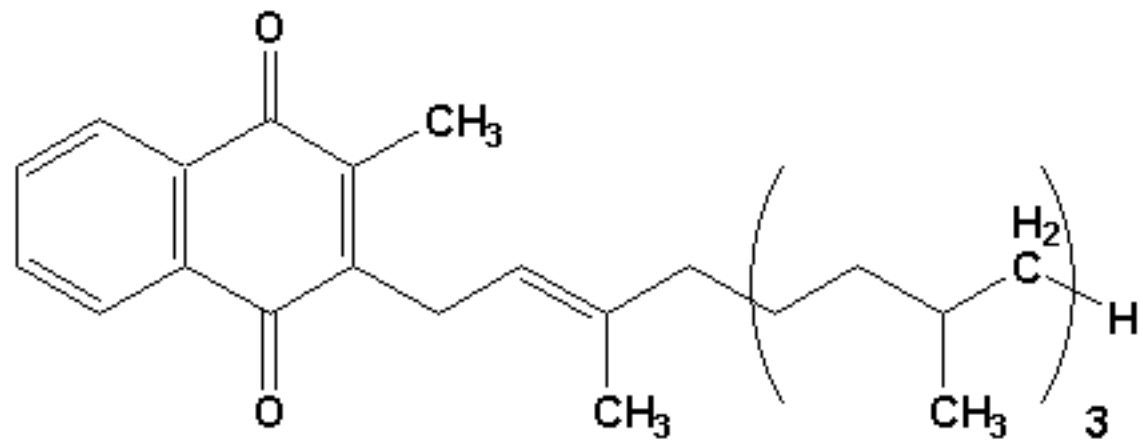

Phylloquinone A1

See also: [Lipid-Soluble Vitamins](#)

INTERNET LINK: [Vitamin K](#)

Lipid-Soluble Vitamins

The four lipid-soluble **vitamins - A,D,E, and K** - are made from the same 5-carbon building blocks (dimethylallyl pyrophosphate and isopentenyl pyrophosphate) as the steroids. Although one of these, **Vitamin D**, is ultimately derived from cholesterol, the other three are not.

Vitamin A - also called all-*trans*-retinol, is an isoprenoid alcohol that plays a key role in vision and a role in controlling animal growth. **Vitamin A** must either be present in the diet, or derived from **β -carotene**, an isoprenoid compound prominent in carrots. See **Figure 19.25** for the biosynthesis of all-*trans*-retinol. Dehydrogenation of retinol yields the aldehyde, **retinal**, which has a role in vision. Another derivative of retinol is **retinoic acid**, which can be made by the oxidation of retinal.

Retinoids (derivatives of retinol) act like steroid hormones and interact with specific receptor proteins in the cell nucleus. The ligand-receptor complexes bind to specific DNA sequences, where they control the transcription of particular genes.

Vitamin D - the most abundant form is D₃, also called cholecalciferol. **Vitamin D** is not technically a vitamin, because it is not required in the diet. It arises from UV-photolysis of 7-dehydrocholesterol, an intermediate in cholesterol biosynthesis (see [here](#)).

Vitamin D regulates calcium and phosphorus metabolism, particularly the synthesis of the inorganic matrix of bone, which consists largely of calcium phosphate.

D₃ undergoes two successive hydroxylations catalyzed by mixed-function oxidases. The first occurs at carbon 25 in liver. When calcium levels are low, hydroxylation occurs at carbon 1, yielding the active form, **1,25(OH)D₃**, which stimulates osteoblasts to take up calcium. In the intestine, **1,25(OH)D₃** stimulates transcription of a protein that stimulates calcium absorption into the bloodstream. When calcium levels are adequate, hydroxylation occurs instead at carbon 24, yielding the inactive **24,25(OH)D₃** form.

Vitamin E - also called α -tocopherol. **Vitamin E** is an antioxidant. It is particularly effective in preventing the attack of peroxides on unsaturated fatty acids in membrane lipids. Deficiency of **vitamin E** also leads to other symptoms, however, so **vitamin E** probably plays other roles as yet undiscovered.

Vitamin K - found in plants as phylloquinone (**vitamin K₁**) and in animals as menaquinone (**vitamin K₂**). **Vitamin K₂** is essential for the carboxylation of glutamate residues in certain proteins, to give γ -carboxyglutamate. This modification allows the

protein to bind calcium, an essential event in the blood clotting cascade. Carboxylation of glutamate is also important in other proteins involved in the mobilization or transport of calcium.

See also: [Steroid Metabolism](#), [Dimethylallyl Pyrophosphate](#), [Isopentenyl Pyrophosphate](#), [Cholesterol Biosynthesis](#), [Chemistry of Photoreception](#)

INTERNET LINKS:

1. [Retinol Metabolism](#)
 2. [Vitamin K](#)
-

Vitamin A (All-*trans*-Retinol)

Vitamin A is a fat soluble vitamin derived from β -carotene. The alcohol form of **vitamin A, retinol**, is the storage form in the body. The aldehyde form, **retinal**, has a role in vision. The acid form, **retinoic acid**, functions in embryonic development. **Vitamin A** acts to some extent in the body as an antioxidant, protecting against oxidative damage.

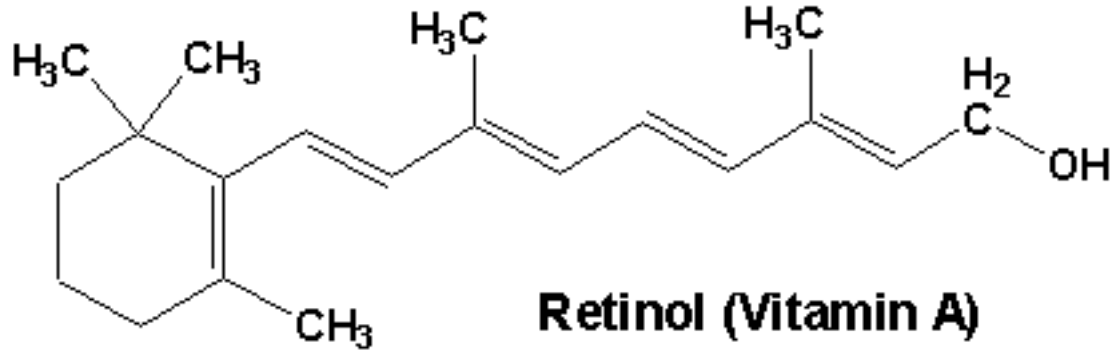

See also: [Antioxidants](#), [Reactive Oxygen](#), [Oxygen Metabolism and Human Disease](#), [\$\beta\$ -Carotene](#), [G Proteins in Vision](#), [Lipid-Soluble Vitamins](#), [Vitamins](#)

INTERNET LINKS:

1. [Retinol Metabolism](#)
 2. [Rod Photoreceptor](#)
-

All-trans-Retinal

All-trans-retinal is a derivative of **vitamin A** involved in vision.

In the eye, specialized photoreceptor cells of the retina, called rod cells are primarily responsible for low-light vision, with relatively little color detection.

Rod cell outer segments contain lamellar protein disks rich in the protein opsin (**Figure 19.26**). Oxidation and isomerization of all-*trans*-**retinol** yields an intermediate, 11-*cis* retinal, which is important in photoreception. The chemistry of photoreception is shown in **Figure 19.27** and summarized as follows.

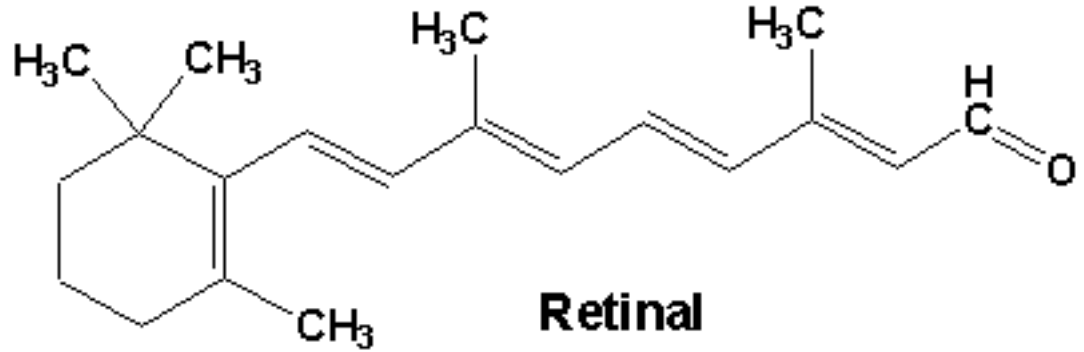

1. 11-*cis*-**retinal** is linked to opsin via a Schiff's base to form **rhodopsin**.
2. Absorption of light by the **retinal** portion of the complex isomerizes the *cis*-bond in 11-*cis* **retinal** to a trans-bond, forming an all-*trans* compound called bathorhodopsin.
3. Release of a proton yields metarhodopsin II
4. Hydrolysis yields opsin and all-*trans* **retinal**.
5. Retinal isomerase converts all-*trans* **retinal** to 11-*cis* **retinal**.

At step 3 above, bathorhodopsin (activated form of rhodopsin) can activate transducin so that it binds **GTP**. The transducin-GTP complex can bind to a specific phosphodiesterase that cleaves **cyclic GMP** to **GMP**. This, in turn, stimulates a cascade of events that generates a visual signal to the brain.

See also: [G Proteins in Vision](#), [Chemistry of Photoreception](#)

INTERNET LINKS: [Rod Photoreceptor](#)

Figure 19.26: Schematic drawing of a rod cell.

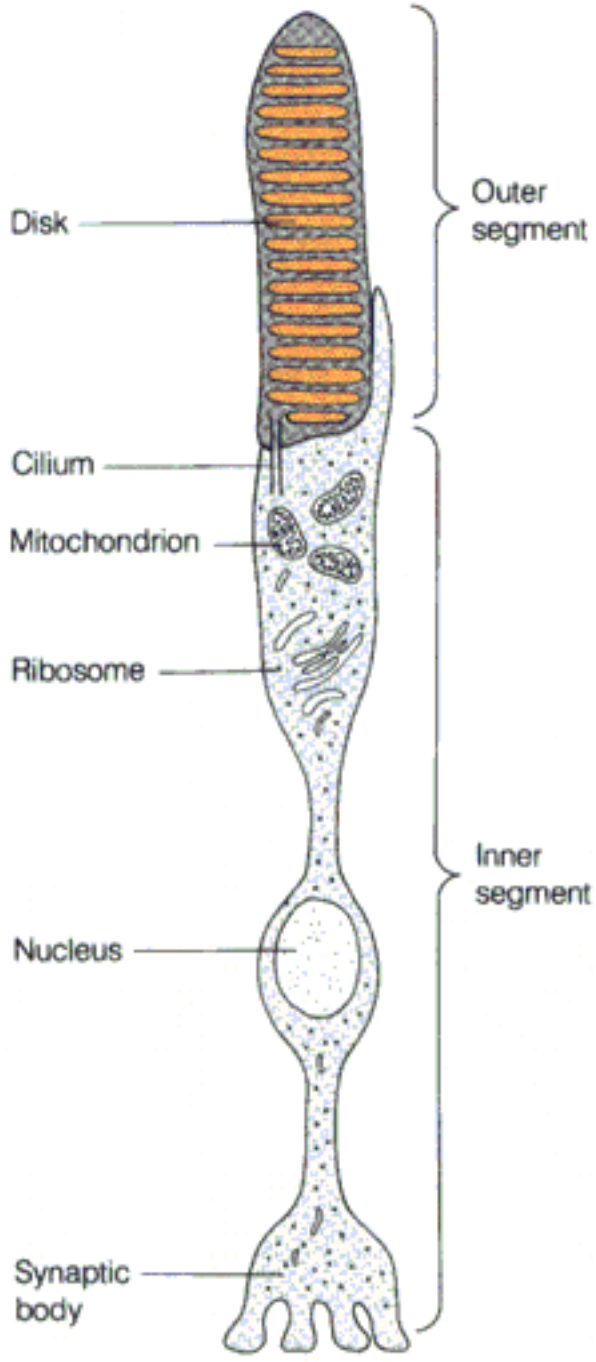
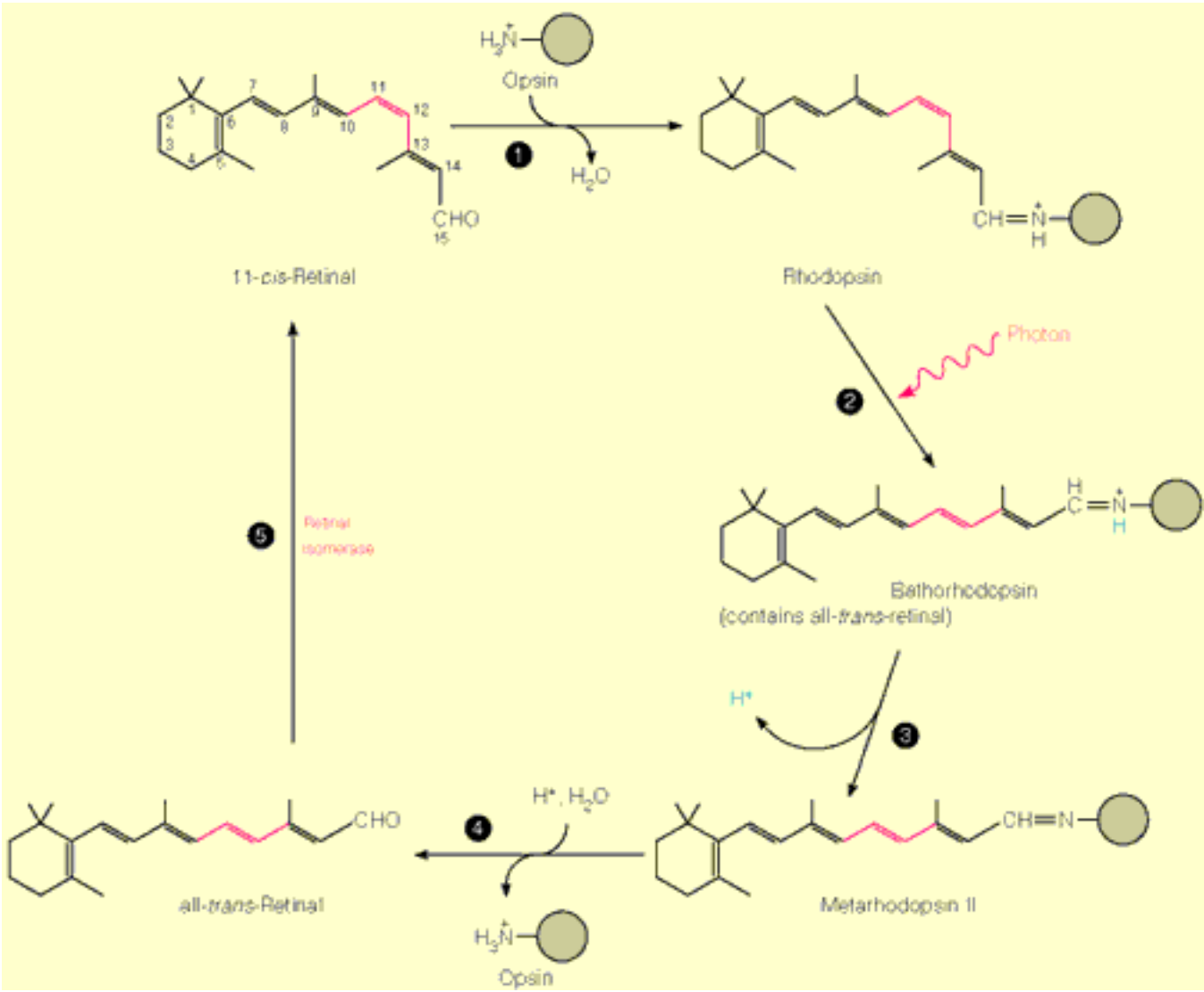

Figure 19.27: The chemical changes in photoreception.



Rhodopsin

Rhodopsin is the name of the complex between the protein opsin and 11-*cis* retinal in the visual process ([Figure 19.27](#), see also [here](#)). Absorption of light by the retinal portion of the complex isomerizes the *cis*-bond in 11-*cis* retinal to a *trans*-bond, forming an all-*trans* compound called **bathorhodopsin**.

Bathorhodopsin (activated form of **rhodopsin**) can activate [transducin](#) so that it binds [GTP](#). The transducin-GTP complex can bind to a specific phosphodiesterase that cleaves [cyclic GMP](#) to [GMP](#). This, in turn, stimulates a cascade of events that generates a visual signal to the brain.

See also: [G Proteins in Vision](#), [Vitamin A](#), [Chemistry of Photoreception](#)

INTERNET LINKS:

1. [Rod Photoreceptor](#)
-

Unnumbered Item

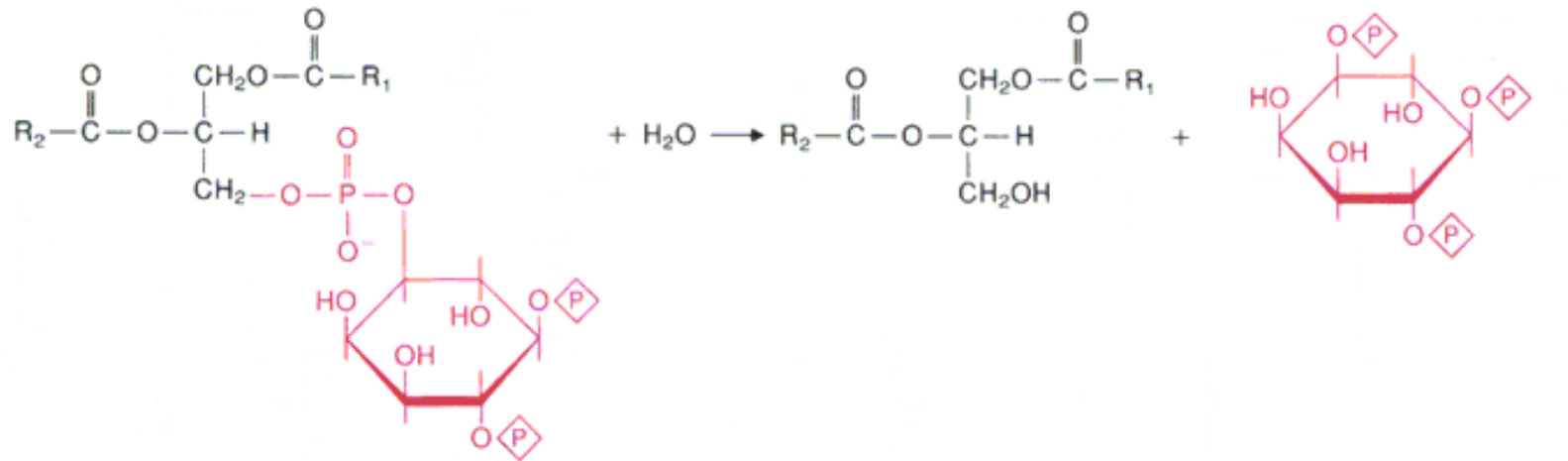

**Phosphatidylinositol
4,5-bisphosphate (PIP₂)**

***sn*-1,2-Diacylglycerol
(DAG)**

**Inositol 1,4,5-trisphosphate
(InsP₃)**

Transducin

Transducin is a protein in the visual process that binds GTP after activation by a form of rhodopsin called bathorhodopsin (Figure 19.27, see also here). The **transducin-GTP complex** can bind to a specific phosphodiesterase that cleaves cyclic GMP to GMP. This, in turn, stimulates a cascade of events that generates a visual signal to the brain.

See also: G Proteins in Vision, Vitamin A, Chemistry of Photoreception

INTERNET LINKS:

1. Rod Photoreceptor
-

Guanosine Triphosphate (GTP)

GTP is used for many purposes in the cell. They include being a source of energy for translation and other cellular processes, a substrate for **RNA polymerase** in synthesis of RNA, and a factor bound by G-proteins in cellular signalling/control mechanisms. **GTP** is produced by substrate level phosphorylation in the citric acid cycle reaction catalyzed by **succinyl-CoA synthetase**.

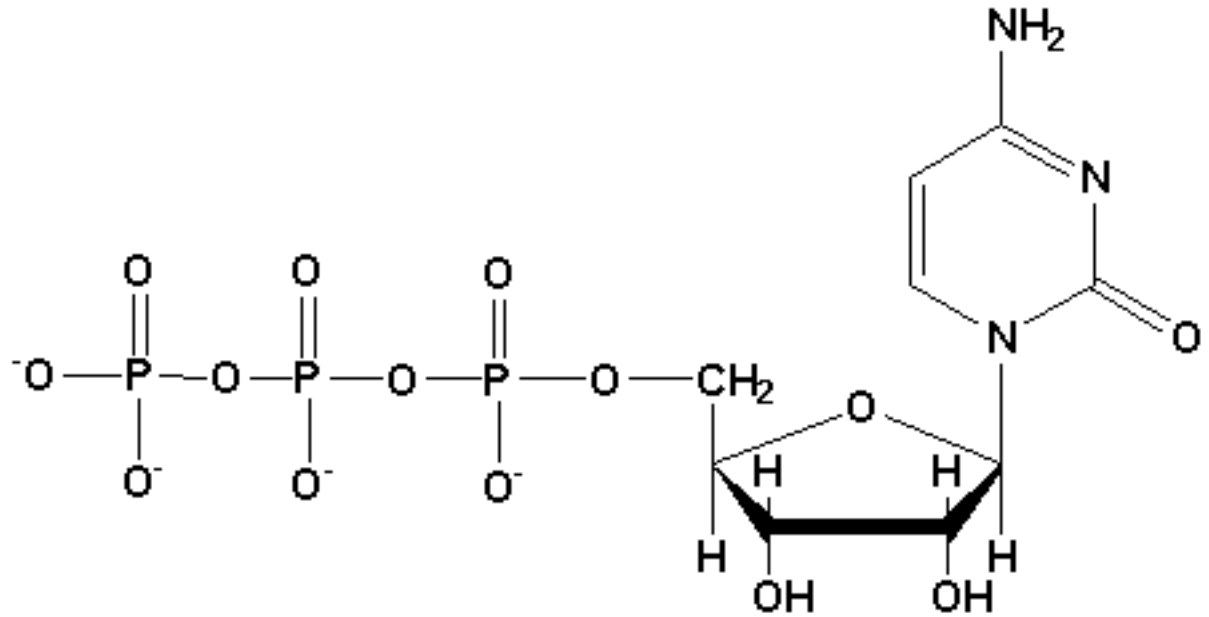

Guanosine Triphosphate (GTP)

See also: [Substrate Level Phosphorylation](#), [Nucleotide Salvage Synthesis](#), [De Novo Biosynthesis of Purine Nucleotides](#), [Nucleotides](#), [Guanine](#), [G Proteins and Signal Transduction](#)

RNA Polymerases

Synthesis - RNA synthesis involves the copying of a template DNA strand by **RNA polymerase**. Though several different types of **RNA polymerase** are known, all catalyze the following basic reaction,



using the rules of complementarity (A-T, G-C, C-G, and U-A, where the bases of ribonucleosides are listed first in each pair and the bases of deoxyribonucleosides are listed second).

Prokaryotic RNA polymerase - A single **RNA polymerase** catalyzes the synthesis of all three *E. coli* RNA classes--**mRNA**, **rRNA**, and **tRNA**. This was shown in experiments with rifampicin (**Figure 26.4a**), an antibiotic that inhibits **RNA polymerase** *in vitro* and blocks the synthesis of mRNA, rRNA, and tRNA *in vivo*.

Eukaryotic RNA polymerases - Eukaryotes contain three distinct **RNA polymerases**, one each for the synthesis of the three larger rRNAs, mRNA, and small RNAs (tRNA plus the 5S species of rRNA). These are called **RNA polymerases I** (see **here**), **II** (**here**), and **III** (**here**), respectively. The enzymes differ in their sensitivity to inhibition by α -**amanitin** (**Figure 26.4b**), a toxin from the poisonous *Amanita* mushroom. **RNA polymerase II** is inhibited at low concentrations, **RNA polymerase III** is inhibited at high concentrations, and **RNA polymerase I** is quite resistant.

Other transcriptional inhibitors - **Cordycepin** (3'-deoxyadenosine) (**Figure 26.4c**), is a transcription chain terminator because it lacks a 3' hydroxyl group from which to extend. The nucleotide of cordycepin is incorporated into growing chains, confirming that transcriptional chain growth occurs in a 5' to 3' direction. Another important **transcriptional inhibitor** is **actinomycin D** (**Figure 26.4d**), which acts by binding to DNA. The tricyclic ring system (phenoxazone) intercalates between adjacent G-C base pairs, and the cyclic polypeptide arms fill the nearby narrow groove.

DNA polymerase vs. RNA polymerase - V_{\max} (see **here**) for the **DNA polymerase III holoenzyme**, at about 500 to 1000 nucleotides per second, is much higher than the chain growth rate for bacterial transcription-50 nucleotides per second, which is the same as V_{\max} for purified **RNA polymerase**. Although there are only about 10 molecules of DNA polymerase III per *E. coli* cell, there are some 3000 molecules of **RNA polymerase**, of which half might be involved in transcription at any one time.

Replicative DNA chain growth is rapid but occurs at few sites, whereas transcription is much slower, but occurs at many sites. The result is that far more RNA accumulates in the cell than DNA. Like the DNA polymerase III holoenzyme, the action of **RNA polymerase** is highly processive. Once transcription of a gene has been initiated, **RNA polymerase** rarely, if ever, dissociates from the template until the specific

signal to terminate has been reached.

Accuracy of template copying - Another important difference between DNA and RNA polymerases is the accuracy with which a template is copied. With an error rate of about 10^{-5} , RNA polymerase is far less accurate than replicative DNA polymerase holoenzymes, although RNA polymerase is much more accurate than would be predicted from Watson-Crick base pairing (see [here](#)) alone. Recent observations suggest the existence of error-correction mechanisms. In *E. coli*, two proteins, called GreA and GreB, catalyze the hydrolytic cleavage of nucleotides at the 3' ends of nascent RNA molecules. These processes may be akin to 3' exonucleolytic proofreading by DNA polymerases. The following, however, are important differences:

1. Cleavage of 3' ends of RNA molecules usually removes oligonucleotides, rather than single nucleotides, and
2. The rate of hydrolysis is much lower than the rate of RNA chain extension by RNA polymerase.

The mechanism of transcriptional error correction is still an open question and the subject of ongoing research efforts.

See also: [Structure of RNA Polymerase](#), [Interactions with Promoters](#), [Initiation and Elongation](#), [Factor-Independent Termination of Transcription](#), [Factor-Dependent Termination of Transcription](#)

INTERNET LINKS:

1. [Regulation of Transcription by RNA Polymerase II](#)
 2. [RNA Polymerase and GreA 3D Structures](#)
-

Messenger RNA (mRNA)

Messenger RNAs are RNA molecules that carry the "message" from the DNA to the ribosomes to be translated into protein. The "message" in **mRNA** is carried in groups of three nucleotides called codons. Each codon specifies one amino acid in a protein according to the rules of the genetic code.

See also: Transcription, Translation, RNA Polymerases, Background on Transcription, RNA Polymerase II Transcription, Eukaryotic Transcription,

INTERNET LINK: The RNA World

RNA



RNA (**R**ibo**N**ucleic **A**cid), like **DNA**, is a form of **nucleic acid** found in cells. **RNA**, like DNA, is a polymer composed of nucleoside monophosphates. The nucleoside monophosphates in **RNA** are called ribonucleoside monophosphates, however, because they contain the sugar **ribose** instead of 2-**deoxyribose**, as is found in DNA.

The bases in **RNA** are **adenine** (A), **guanine** (G), **cytosine** (C), and **uracil** (U). These are the same bases as DNA except that the base uracil is used in place of **thymine** (T). Unlike DNA, **RNA** is rarely composed of two strands base paired with each other. Instead, **RNA** exists as a single-stranded entity, though extensive regions of many **RNAs** may form double helices within themselves by the base pairing rules.

The three predominant forms of **RNA** are all involved in translating the genetic information in the sequence of bases in DNA to a sequence of amino acids in proteins. They are called messenger **RNA** (mRNA), transfer **RNA** (tRNA), and ribosomal **RNA** (rRNA).

mRNA is made directly from DNA, so **mRNA** carries the genetic information in the DNA sequence from the cell nucleus to the **ribosomes** where **proteins** are made. Information is organized in DNA (and **mRNA**) in a sequence of three nucleotides called a **codon**. One codon specifies the incorporation of a specific **amino acid** into a protein.

tRNAs translate the **genetic code**. One end of the **tRNA** contains a three nucleotide sequence called the anticodon loop that is complementary to the codon of the mRNA. The other end of the **tRNA** is covalently attached to a specific amino acid. Because the amino acid carried by a **tRNA** is specific for each anticodon and each **anticodon** is complementary to the codons in **mRNA**, the **tRNA** provide the link between **nucleic acid sequence** and amino acid sequence for a protein during translation. This process, which occurs on **ribosomes**, sequentially incorporates amino acids corresponding to the order of codons in the **mRNA**. **tRNAs** contain numerous chemical modifications to the bases within them. Examples include pseudouridine, ribothymidine, and dihydrouridine (See **Figure 27.7**)

rRNA is a component of the ribosomes where **translation** (protein synthesis) is occurring.

Another type of **RNA** in eukaryotic cells, called **snRNA** (for small nuclear **RNA**) helps process some **RNAs** after they are made (see **here**). Many eukaryotic **RNAs** have portions of them removed by a process called **splicing**. It is this process in which the **snRNAs** participate.

See also: [Transcription](#), [Ribozymes](#)

INTERNET LINKS:

1. [The RNA World](#)
 2. [RNA Secondary Structures](#)
-

DNA

DNA (DeoxyriboNucleic Acid) is called the genetic material because it contains the genetic information for every cell and tissue in an organism. **DNA** is a component of the chromosomes (proteins are the other component). **DNA** is one of two types of nucleic acid. Ribonucleic acid (RNA) is the other. As such, **DNA** is a polymer of deoxyribonucleotides linked through phosphodiester bonds ([Figure 4.1](#)).

[Deoxyribonucleotides](#) contain three components - a phosphate group, a modified sugar called [deoxyribose](#), and a nitrogenous base (see [here](#)) ([adenine](#), [guanine](#), [cytosine](#), or [thymine](#)). Adenine and guanine are called [purine](#) bases, whereas cytosine and thymine are called [pyrimidine](#) bases.

Deoxyribonucleotides are also called deoxyribonucleoside mono-, di-, or triphosphates if they contain 1, 2, or 3 phosphates, respectively. Deoxyadenosine triphosphate, for example, is a nucleoside triphosphate.

As seen in [Figure 4.1](#), **DNA** is a polymer of nucleoside monophosphates. The backbone of the chain consists of alternating units of phosphate and sugar. The asymmetry of the nucleoside monophosphate monomers of **DNA** gives the chain a "polarity". We describe **DNA**'s polarity relative to the numbering of the carbons in deoxyribose. In [Figure 4.1](#), for example, the chain is said to be oriented 5' to 3' as it goes from top to bottom. That is, the phosphate residue is attached to the hydroxyl on the 5' carbon of one sugar residue and the 3' hydroxyl of the next one.

In cells, **DNA** consists of two strands wound around each other in a double-helical structure such that the phosphate-deoxyribose backbone is on the outside and the bases are on the inside. ([Figure 4.11](#) and [Figure 4.15b](#)). The polarity of the two strands in a **DNA** molecule is opposite; that is, the 5' end of one strand matches up to the 3' end of the other strand. Thus, the strands are said to be "antiparallel."

The arrangement of bases in double-stranded **DNA** is not random. Adenine on one strand is always arranged adjacent to a thymine on the other strand and vice-versa. Guanine is similarly paired with cytosine and vice-versa. Hydrogen bonds between the base pairs hold the two strands together ([Figure 4.10a](#)). As Watson and Crick (discoverers of the structure of **DNA**) noted, the complementary nature of the bases provides a reasonably simple means for the molecule to be replicated because all of the information for making double-stranded **DNA** is contained within one of the two strands.

DNA is found in three predominant forms in cells - called **B-DNA**, **A-DNA**, and **Z-DNA** ([Figures 4.15](#) and [4.26](#)). Of these, the **B-DNA** form predominates. [Figure 4.15](#) shows that both **B-** and **A-DNA** have major and minor grooves due to the particular orientation of the paired bases. In **B-DNA**, however, the two grooves are quite distinguishable, whereas in the **A-DNA** they are more nearly equal in width. Both **B-** and **A-DNA** are right-handed helices, whereas **Z-DNA** is a left-handed helix. [Table 4.3](#) compares some of the physical parameters of **B-**, **A-**, and **Z-DNA**. Within **DNA** is the information necessary for making proteins (the workhorses of the cell). Proteins are not made directly from **DNA**, however.

Instead, a complementary copy of the relevant portion of the **DNA** is made in the form of messenger RNA (**mRNA**), which is translated on a particle called a **ribosome**, using the **genetic code**, to direct the synthesis of protein.

See also: [Nucleic Acids](#), [Nucleoside and Nucleotide Naming](#), [Phosphodiester Bonds](#), [RNA](#), [Proteins](#)

INTERNET LINKS:

1. [DNA](#)
 2. [DNA Database at NCBI](#)
-

Figure 4.1: Chemical structures of ribonucleic acid (RNA) and deoxyribonucleic acid (DNA).

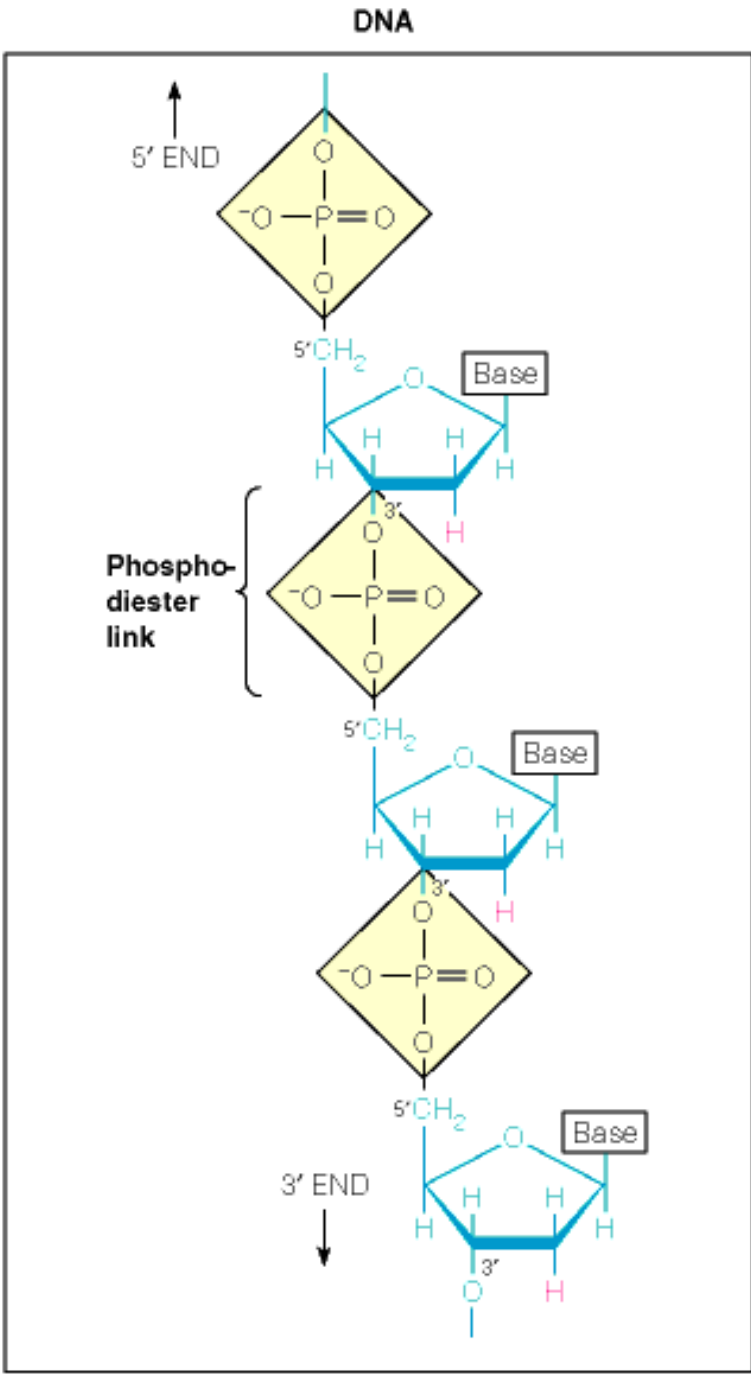
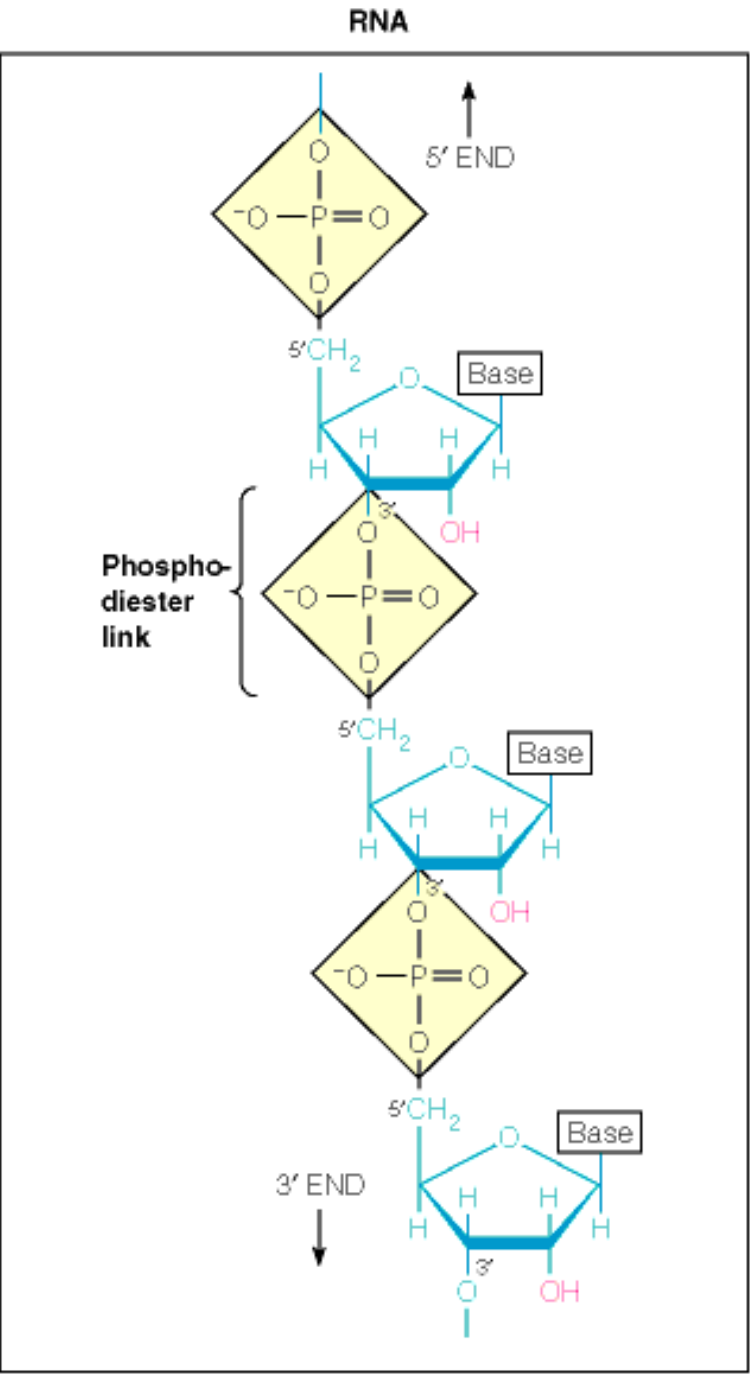

Nucleotides

Ribonucleotides and **deoxyribonucleotides** (collectively called **nucleotides**) are the building blocks of the **nucleic acids**, **RNA** and **DNA**, respectively. **Nucleotides** are composed of a sugar, a phosphate, and a base (see below).

The composition of DNA differs from that of RNA in only two respects. First, DNA uses **nucleotides** containing the sugar deoxyribose. RNA's **nucleotides** contain the sugar ribose. Second, DNA uses the bases **adenine**, **guanine**, **cytosine**, and **thymine**. RNA uses the bases adenine, guanine, cytosine, and **uracil**.

Nucleotides differ from **nucleosides** in that the latter do not contain phosphate, so we sometimes refer to **nucleotides** as nucleoside (mono, di, or tri)-phosphates. For example, adenosine diphosphate is a **nucleotide** (also called ADP) **Deoxyribonucleotides** (written with a 'd') differ from **ribonucleotides** in containing **deoxyribose** as the sugar moiety instead of **ribose**. In some naming schemes, deoxythymidine **nucleotides** are written without the 'd', but the 'd' convention will be used here.

The table below lists the most common nucleotides found in cells.

<u>AMP</u>	<u>CMP</u>	<u>GMP</u>	<u>UMP</u>
<u>ADP</u>	<u>CDP</u>	<u>GDP</u>	<u>UDP</u>
<u>ATP</u>	<u>CTP</u>	<u>GTP</u>	<u>UTP</u>
<u>dAMP</u>	<u>dCMP</u>	<u>dGMP</u>	<u>dTMP</u>
<u>dADP</u>	<u>dCDP</u>	<u>dGDP</u>	<u>dTDP</u>
<u>dATP</u>	<u>dCTP</u>	<u>dGTP</u>	<u>dTTP</u>
<u>cAMP</u>	<u>dUMP</u>	<u>dUDP</u>	<u>dUTP</u>

See also: [Figure 4.2](#), [Figure 4.3](#)

Nucleic Acids



Nucleic acid is the general name for the macromolecules [RNA](#) and [DNA](#). They are each made up of a polymer of nucleoside monophosphates or deoxynucleoside monophosphates, respectively, with the 5' phosphate of each group forming a phosphodiester bond with the 3' hydroxyl of the subsequent group ([Figure 4.1](#))

See also: [Proteins](#), [Nucleotides](#), [RNA](#), [DNA](#), [Genetic Code](#)

Proteins

Proteins -

1. **Proteins** are biopolymers (called polypeptides) of L-amino acids.
2. Amino acids in **proteins** are joined to each other via peptide bonds.
3. Only L-amino acids are used to make **proteins** (rare exceptions of proteins in bacterial cell wall, which contain some D-amino acids)
4. The process of putting amino acids together to make **proteins** is called translation.
5. Translation relies on the genetic code, in which three nucleotides in mRNA specify one amino acid in **protein**.
6. The order or sequence of amino acids distinguishes different **proteins** from each other. The sequence of amino acids determines the 3-dimensional shape of the **protein**. Alterations to the amino acid sequence of a **protein** changes its 3D shape.
7. The difference between a polypeptide and a **protein** is that the term polypeptide refers simply to a chain of amino acids. The term **protein** refers to the chain of amino acids after it folds properly and is (in some cases) modified. **Proteins** may consist of more than one polypeptide chain.
8. **Proteins** are sometimes described as the "workhorses" of the cell because they do so many things - catalyze reactions, provide structural integrity, transport molecules, provide movement, bind molecules, and others.

See also: [Amino Acids](#), [Peptide Bonds](#), [Translation](#), [Genetic Code](#), [Polypeptides](#), [Nucleic Acids](#), [RNA](#), [Translation Overview](#) (from Chapter 27), [The Genetic Code](#), [Polyampholytes](#)

Amino Acids

Amino acids are organic acids containing an amine group. The most common **amino acids** are α -amino acids and the most common α **amino acids** are the **L- α -amino acids**.

It is important to understand the following about **amino acid** structure:

1. Only 20 **L- α -amino acids** are used to make **proteins** ([Figure 5.3](#) and [Figure 5.5](#)). Rare exceptions are bacterial membrane proteins, which contain a few **D-Amino Acids**, modified amino acids - primarily lysine (see [here](#)) and proline (see [here](#)), and occasional incorporation of the rare amino acid, [selenocysteine](#)).
2. Side groups (labelled "R" in [Figure 5.4](#)) are what distinguish the α **amino acids** from each other.
3. **Amino acids** can exist as [zwitterions](#) - substances containing equal numbers of positive and negative charge - due to their carboxyl and amine groups, which can be negatively and positively charged, respectively.

Several common **amino acids** found in cells, such as [ornithine](#) and [citrulline](#), are not used to make proteins.

Amino acids are the monomeric units or "building blocks" of proteins that are joined together covalently in [peptide bonds](#).

Amino acids are built into proteins by the process of [translation](#) using the [genetic code](#).

See also: [Amino Acid Information](#), [Table 5.2](#), [Stereochemistry](#)

INTERNET LINKS:

1. [SECOST - Sequence-Conformation-Structure Database for Amino Acids in Proteins](#)
2. [IMB-Jena Amino Acid Repository](#)
3. [Introduction to Amino Acids](#)



Figure 5.3: The amino acids found in proteins.

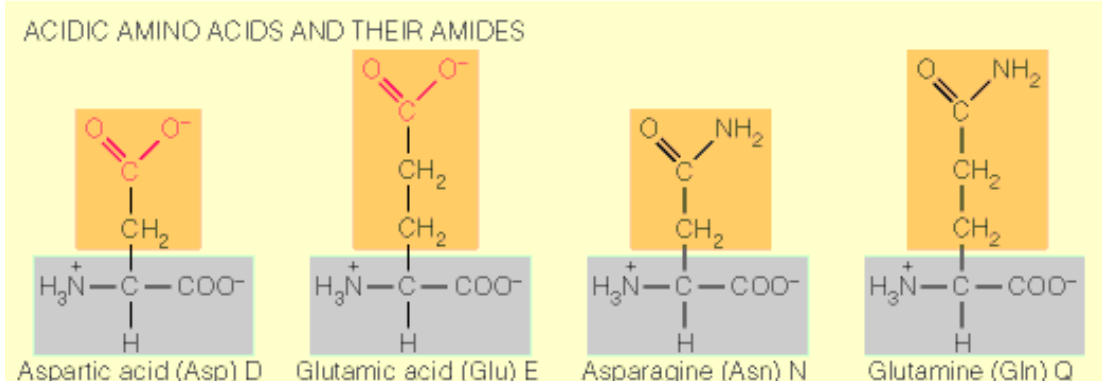
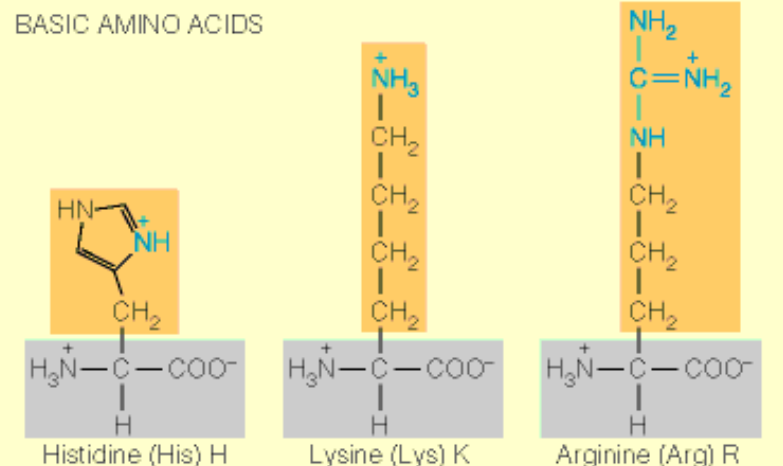
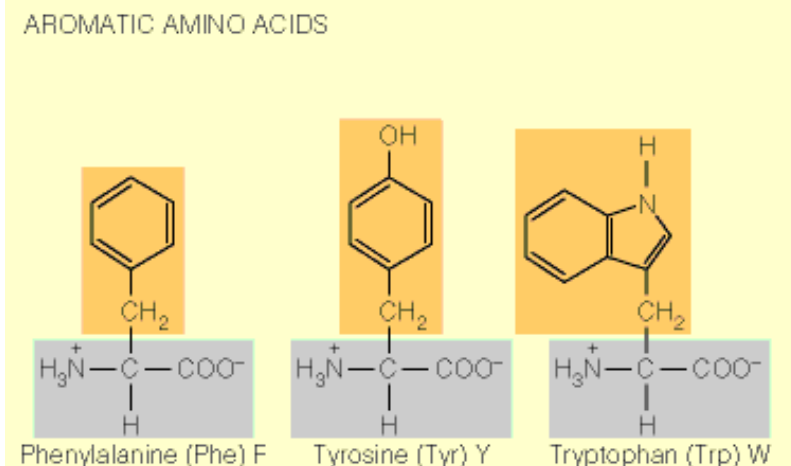
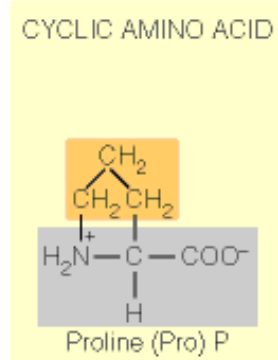
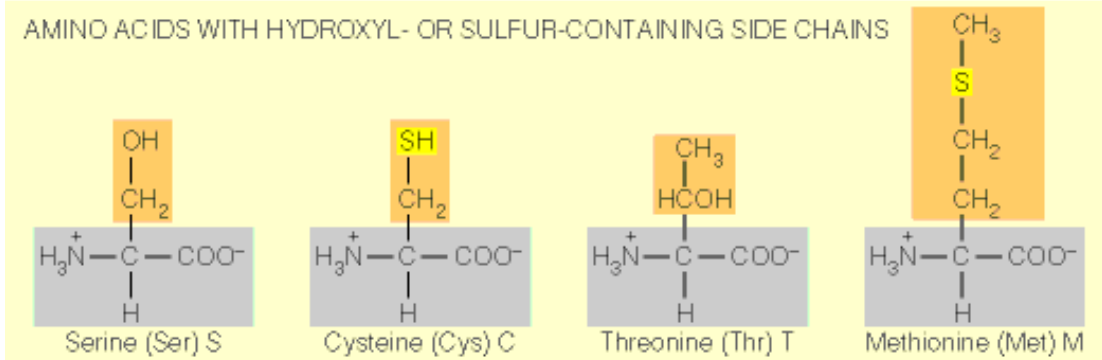
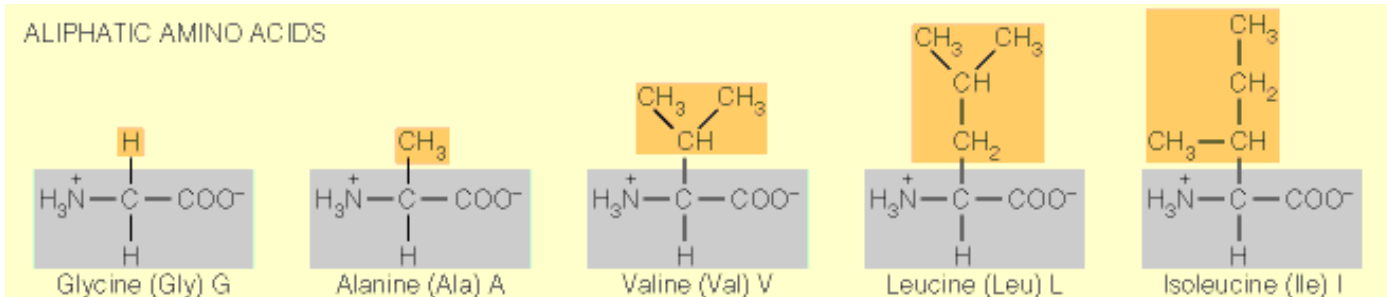
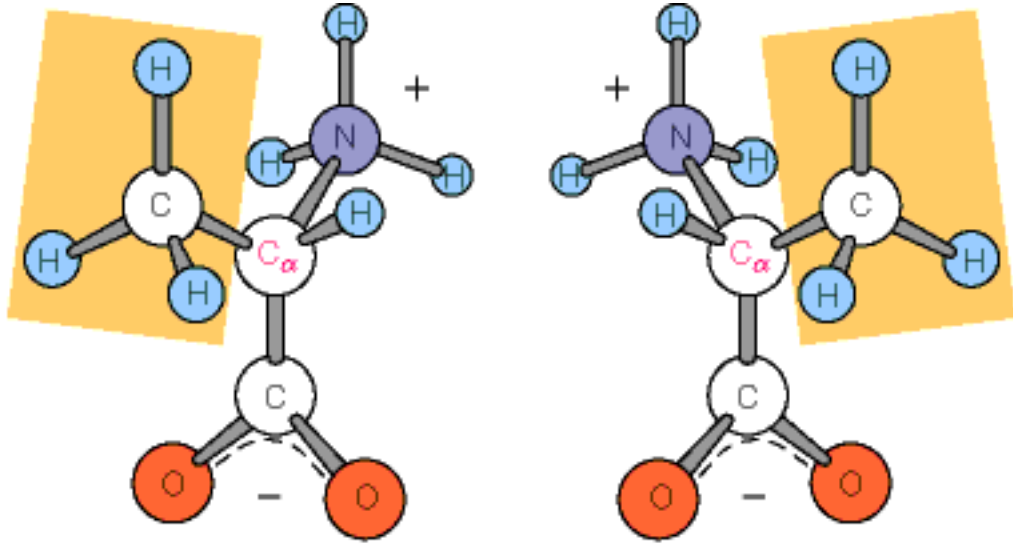
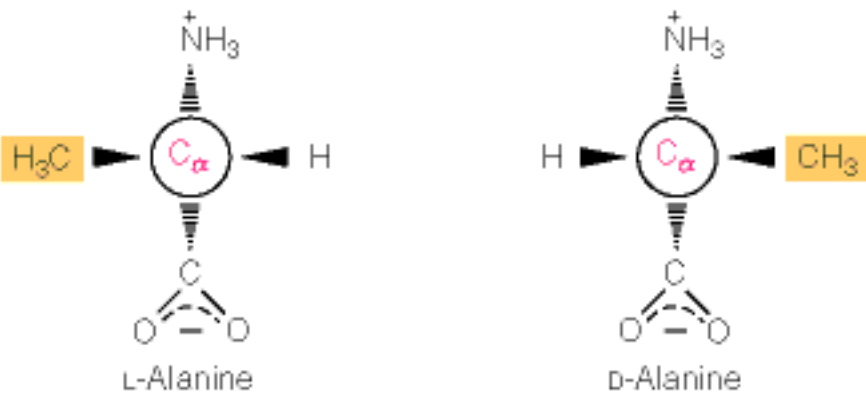

Figure 5.5: Stereoisomers of α -amino acids.



(a) L-Alanine and D-Alanine



(b) L-Alanine and D-Alanine

D-Amino Acids

Amino acids have two possible stereochemical configurations - D and L. L-Amino acids are the forms that are found in biological proteins. **D-Amino acids** are found in rare proteins, such as the bacterial cell wall polypeptides ([Figure 9.26](#)), where they are thought to protect against protease digestion.

See also: [Amino Acids](#), [D-Alanine](#), [D-Glutamic Acid](#)

Figure 9.26: The peptidoglycan layer of Gram positive bacteria.

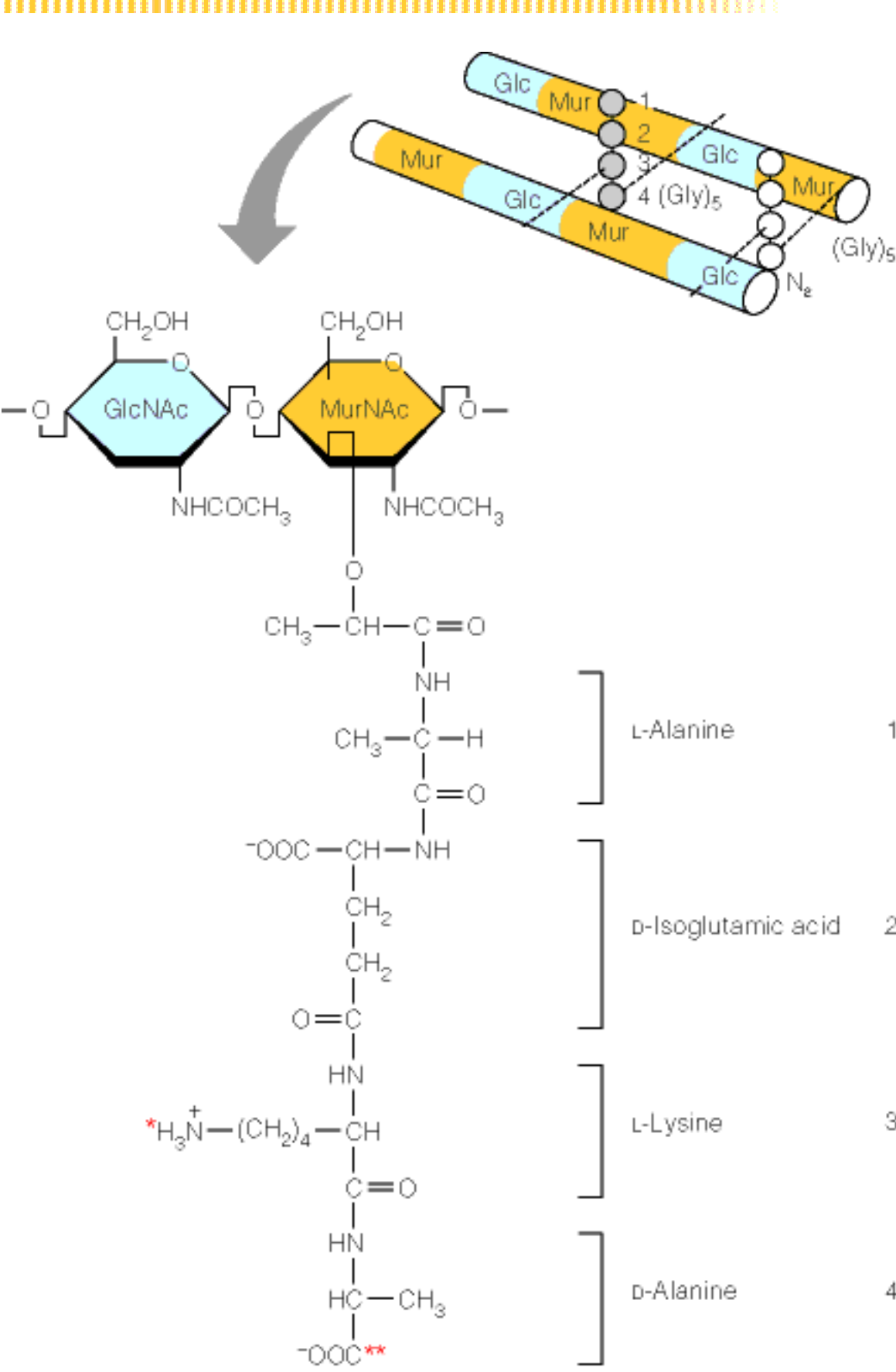

D-Alanine



D-Alanine is a stereoisomer of [L-alanine](#), which is found in proteins. **D-Alanine** is not a normal component of proteins, but is found in the polypeptides of some bacterial cell walls ([Figure 9.26](#)) where it may function to protect the bacterium against attack by peptidases.

See also: [D-Amino Acids](#), [Amino Acids Not In Proteins](#), [Bacterial Cell Walls](#)

Alanine (ALA or A)

L-Alanine is one of the 20 [amino acids](#) commonly found in proteins. Under the essential or non-essential categorization of amino acids, **Alanine** is a non-essential amino acid, meaning it does not need to be present in the diet.

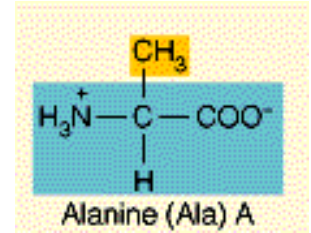

The methyl side chain of **alanine** results in it being classified as an aliphatic amino acid. The more hydrophobic amino acids are usually found within a protein molecule, where they are shielded from water.

Alanine can be made by several metabolic processes. Most commonly it is made by transfer of an amine group to pyruvate (reaction 2 below). **Alanine** is also a product of [tryptophan](#) catabolism.

Like all the other amino acids in proteins, the L isomer of **alanine** is exclusively used, though [D-alanine](#) can be found as a component of bacterial cell walls. Another variant of **alanine**, called β -[alanine](#), has the amino group on the β carbon and is found in [pantothenic acid](#). **Alanine** can be formed by transamination of pyruvate and thus has close links to pathways such as [glycolysis](#), [gluconeogenesis](#), and the [citric acid cycle](#).

Metabolic reactions involving **alanine**:

1. **Alanine** + α -[Ketoglutarate](#) \rightleftharpoons [Pyruvate](#) + [Glutamate](#) (catalyzed by [Aminotransferase](#)).
2. [Glutamate](#) + [Pyruvate](#) \rightleftharpoons α -[Ketoglutarate](#) + **Alanine** (catalyzed by [SGPT](#)).

One Letter Code	Three Letter Code	Molecular Wt. (Daltons)	Genetic Code Codons
A	ALA	71.08	GCA, GCC, GCG, GCU

Alanine is an allosteric inhibitor of [glutamine synthetase](#), an enzyme with a central role in nitrogen metabolism in the cell. **Alanine** participates in transamination reactions and in the [glucose-alanine cycle](#).

See also: [Table 5.1, Genetic Code](#), [Gluconeogenesis](#), [Transamination in Amino Acid Metabolism](#) (from Chapter 20), [Citric Acid Cycle Intermediates in Amino Acid Metabolism](#) (from Chapter 21), [Essential Amino Acids](#)

INTERNET LINK: [Alanine Aspartate Metabolism](#)

Tryptophan

Tryptophan is an α **amino acid** found in proteins. In mammals, **tryptophan** is an essential amino acid, meaning it must be present in the diet.

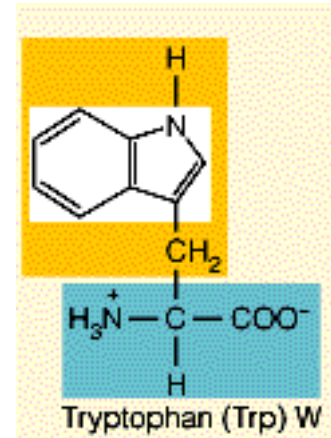

Tryptophan's side chain classifies it as an aromatic amino acid. The aromatic amino acids, like most compounds carrying conjugated rings, exhibit strong absorption of light in the near-ultraviolet region of the spectrum (**Figure 5.6**). This absorption is frequently used for the analytical detection of proteins.

Tyrosine and **tryptophan** have some hydrophobic character, but it is tempered by the polar groups in their side chains. In addition, tyrosine can ionize at high pH.

Tryptophan is an allosteric inhibitor of **glutamine synthetase**, an enzyme with a central role in nitrogen metabolism in the cell.

One Letter Code	Three Letter Code	Molecular Wt. (Daltons)	Genetic Code Codons
W	TRP	186.21	UGG

See also: [Table 5.1, Genetic Code](#), [Metabolism of Aromatic Amino Acids and Histidine](#), [Essential Amino Acids](#)

INTERNET LINKS:

1. [Phenylalanine, Tyrosine, and Tryptophan Biosynthesis](#)
2. [Tryptophan Metabolism](#)

Figure 5.6: Absorption spectra of the aromatic amino acids in the near-ultraviolet region.

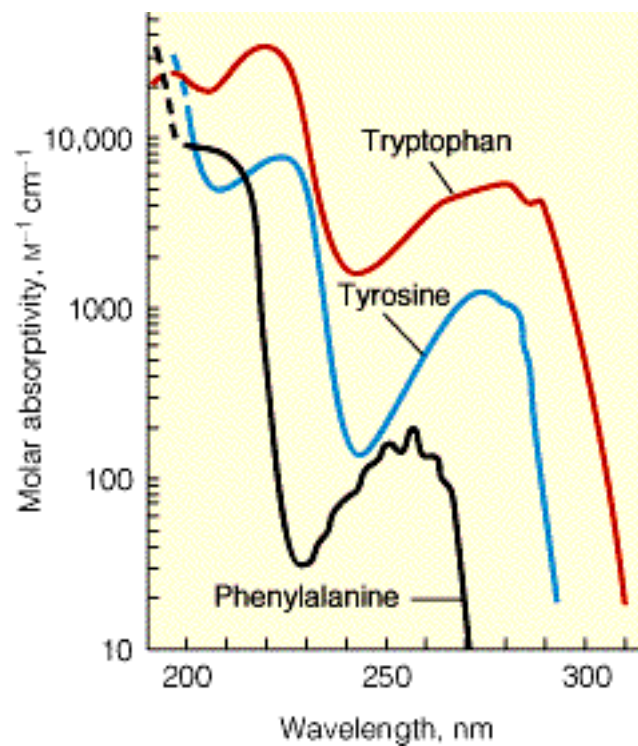

From D. Wetlaufer, *Adv. Protein Chem.* (1962) 17:303-390. © 1962 Academic Press.

Tyrosine

Tyrosine is an α **amino acid** found in proteins. In mammals, **tyrosine** is a non-essential amino acid, meaning it does not need to be present in the diet. **Tyrosine's** hydroxyl group is a target for phosphorylation in some proteins.

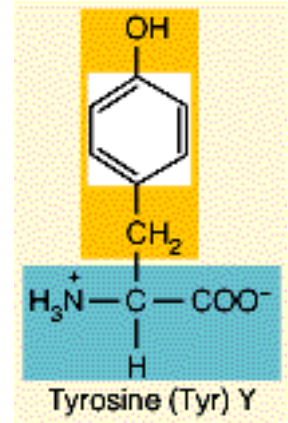

Tyrosine's benzene-ring side chain classifies it as an aromatic amino acid. The aromatic amino acids, like most compounds carrying conjugated rings, exhibit strong absorption of light in the near-ultraviolet region of the spectrum (**Figure 5.6**). This absorption is frequently used for the analytical detection of proteins. **Tyrosine** and **tryptophan** have some hydrophobic character, but it is tempered by the polar groups in their side chains. In addition, **tyrosine** can ionize at high pH.

One Letter Code	Three Letter Code	Molecular Wt. (Daltons)	Genetic Code Codons
Y	TYR	163.18	UAU, UAC

See also: [Table 5.1, Genetic Code](#), [Metabolism of Aromatic Amino Acids and Histidine](#), [Essential Amino Acids](#)

INTERNET LINKS:

1. [Phenylalanine, Tyrosine, and Tryptophan Biosynthesis](#)
 2. [Tyrosine Metabolism](#)
-

Table 5.1



Name	Abbreviations	pK _a of α-COOH Group	pK _a of α-NH ₃ ⁺ Group	pK _a of Ionizing Side Chain ^a	Residue ^b Mass (daltons)	Occurrence ^c in Proteins (mol %)
Alanine	A, Ala	2.3	9.7	—	71.08	9.0
Arginine	R, Arg	2.2	9.0	12.5	156.20	4.7
Asparagine	N, Asn	2.0	8.8	—	114.11	4.4
Aspartic acid	D, Asp	2.1	9.8	3.9	115.09	5.5
Cysteine	C, Cys	1.8	10.8	8.3	103.14	2.8
Glutamine	Q, Gln	2.2	9.1	—	128.14	3.9
Glutamic acid	E, Glu	2.2	9.7	4.2	129.12	6.2
Glycine	G, Gly	2.3	9.6	—	57.06	7.5
Histidine	H, His	1.8	9.2	6.0	137.15	2.1
Isoleucine	I, Ile	2.4	9.7	—	113.17	4.6
Leucine	L, Leu	2.4	9.6	—	113.17	7.5
Lysine	K, Lys	2.2	9.0	10.0	128.18	7.0
Methionine	M, Met	2.3	9.2	—	131.21	1.7
Phenylalanine	F, Phe	1.8	9.1	—	147.18	3.5
Proline	P, Pro	2.0	10.6	—	97.12	4.6
Serine	S, Ser	2.2	9.2	—	87.08	7.1
Threonine	T, Thr	2.6	10.4	—	101.11	6.0
Tryptophan	W, Trp	2.4	9.4	—	186.21	1.1
Tyrosine	Y, Tyr	2.2	9.1	10.1	163.18	3.5
Valine	V, Val	2.3	9.6	—	99.14	6.9

^aApproximate values found for side chains on the *free* amino acids.

^bTo obtain the mass of the amino acid itself, add the mass of a mole of water, 18.02 g. The values given are for neutral side chains; slightly different values will apply at pH values where protons have been gained or lost from the side chains.

^cAverage for a large number of proteins. Individual proteins can show large deviations from these values.

Genetic Code

A **code** is used for converting one type of symbolism to another. For example, the ASCII **code** of computers specifies that each letter of the keyboard has a numerical equivalent - "A" is equivalent to ASCII code 65, etc.

		Second position						
		U	C	A	G			
U	UUU	Phe	UCU } UCC } UCA } UCG } Ser	UAU } UAC } Tyr	UGU } UGC } Cys	U		
	UUC					C		
	UUA	Leu		UAA	Stop	UGA	Stop	A
	UUG			UAG	Stop	UGG	Trp	G
C	CUU	Leu	CCU } CCC } CCA } CCG } Pro	CAU } CAC } Gln	CGU } CGC } CGA } CGG } Arg	U		
	CUC					C		
	CUA	A						
	CUG	G						
A	AUU	Ile	ACU } ACC } ACA } ACG } Thr	AAU } AAC } Asn	AGU } AGC } AGA } AGG } Arg	U		
	AUC					C		
	AUA	A						
	AUG	Met/start		G				
G	GUU	Val	GCU } GCC } GCA } GCG } Ala	GAU } GAC } Asp	GGU } GGC } GGA } GGG } Gly	U		
	GUC					C		
	GUA	A						
	GUG	G						

Cells encode information about the sequence of amino acids for making proteins in nucleic acids. This is called the **genetic code**.

Nucleic acids are polymers of four different nucleotides, whereas proteins are polymers of 20 different amino acids. Thus, each nucleotide cannot stand for one amino acid. Neither can two nucleotides code for one amino acid, because there would be only 16 combinations of two nucleotides ($4^2 = 16$). In reality, three nucleotides **code** for one amino acid in a protein ($4^3 = 64$, so there is room for redundancy in the **genetic code**). The grouping of three nucleotides that **code** for one amino acid is called a codon.

The **genetic code** is used in the process of translation to make proteins. We refer to any region of DNA that codes for protein as a "coding sequence" or a "coding region."

The **genetic code** is fairly "universal," meaning that the same code is used by all organisms, from

bacteria to humans. A few rare variations of the **genetic code** are known, but they are the exception, not the rule.

See also: [Nucleotides](#), [Codons](#), [Genetic Code](#) (from Chapter 27), [Stop codon](#), [mRNA](#), [1&3 Letter Amino Acid Codes](#)

INTERNET LINK: [Reading the Message in Genes](#)

Translation

The genetic information in [DNA](#) is transcribed into messenger RNA ([mRNA](#)). mRNA, in turn, is used to specify the exact sequence of amino acids in a protein according to the [genetic code](#). This process, which is called **translation**, occurs in protein-RNA complexes called [ribosomes](#).

Special RNA molecules called transfer RNA ([tRNA](#)) actually perform the **translation** because they contain a three nucleotide sequence at one end, called an [anticodon](#), that is complementary to the [codon](#) of the mRNA. At the other end of the tRNA, an [amino acid](#) (specific to the anticodon) is attached. The amino acid is covalently joined (via a [peptide bond](#)) to the growing polypeptide chain on the ribosome (See [Figure 5.20](#)).

See also: [Translation Overview](#) (from Chapter 27), [Proteins](#)

INTERNET LINK: [Translation: Protein Synthesis](#)

Ribosomes

The **ribosome** is the structure on which translation occurs. [Figure 27.13](#) shows that the prokaryotic **ribosome** consists of two large subunits. Each subunit, in turn, consists of multiple proteins and RNA. The 70S, 50S, and 30S designations refer to centrifugation sedimentation coefficients, which reflect the size of each entity, but are not strictly additive.

The 50S subunit is called the large subunit. It contains 31 separate single-copy proteins and one, designated as L7/L12, which is present in four copies. Proteins in the large subunit are numbered and begin with the letter 'L' to indicate they are from the large subunit. The 50S subunit also contains 2 ribosomal RNA (**rRNA**) sequences called 23S (2904 residues in length) and 5S (120 residues in length). Again, the 'S' is a relative size measure based on centrifugation properties.

The 30S subunit is called the small subunit. It contains 21 proteins and a single rRNA sequence, called 16S (1542 residues in length). Proteins in the small subunit are numbered and begin with the letter 'S' to indicate they are from the small subunit. One protein is found in both the large and small subunits. It is called L26 in the large subunit and S20 in the small subunit.

The amino acid sequence of each ribosomal protein is known. There are no significant homologies among the proteins of a **ribosome**, but sequences of corresponding proteins in different organisms show considerable evolutionary conservatism.

The 16S rRNA in the small subunit contains many regions of self-complementarity, which are capable of forming double-helical segments ([Figure 27.15](#)). The potentially double-stranded regions are highly conserved among a wide variety of otherwise unrelated organisms. The 16S rRNA folds into a three dimensional structure in the **ribosome** and is bound by multiple **ribosomal** proteins.

See also: [Internal Ribosomal Structure](#), [Translation](#), [Initiation of Translation](#), [Elongation of Translation](#), [Termination of Translation](#), [Antibiotic Inhibition of Translation](#), [Genetic Code](#), [Codons](#)

INTERNET LINKS:

1. [Ribosome Database Project](#)
2. [rRNA Database](#)
3. [16S rRNA Secondary Structures](#)

4. Ribosomal RNA Mutation Database

Figure 27.13: Components of a 70S prokaryotic ribosome.

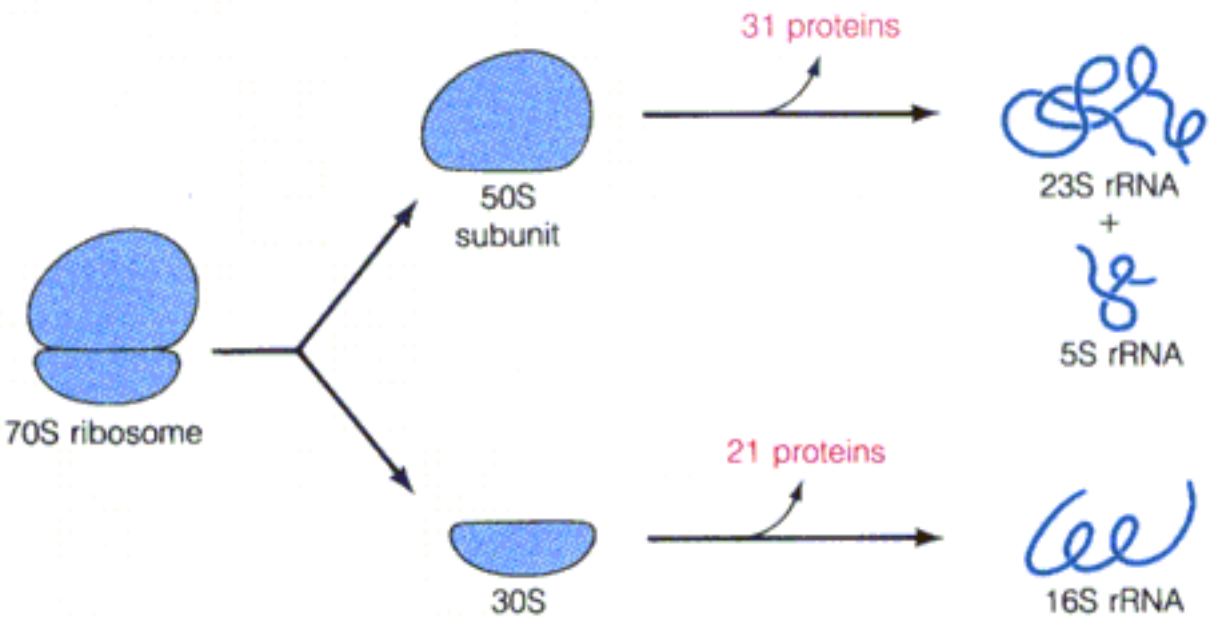

Ribosomal RNA (rRNA)

rRNA is a type of **RNA** that is a component of **ribosomes** and plays a role in the process of **translation** (making **protein** from **nucleic acid** sequence).

See also: [Translation Overview](#), [Eukaryotic vs Prokaryotic Translation](#), [Figure 27.15](#), [Stringent Response](#), [Posttranscriptional Processing of rRNA and tRNA](#)

INTERNET LINKS:

1. [rRNA Database](#)
 2. [The RNA World](#)
 3. [RNA Secondary Structures](#)
 4. [5S rRNA Homepage](#)
 5. [Ribosomal RNA Mutation Database](#)
-

Translation

Once the genetic information in [DNA](#) has been transcribed onto [RNA](#), the RNA must be used to direct the synthesis of a specific protein. The process of reading the RNA and converting it into the sequence for a protein is called **translation**. [Figure 4.22](#) shows the basic principles of **translation**.

The RNA transcribed with the information from DNA is called messenger RNA ([mRNA](#)). The sequence of bases in the mRNA is read on protein/RNA complexes called [ribosomes](#) using another type of [RNA](#) called transfer RNA ([tRNA](#)).

The mRNA sequence is read in single units of three nucleotides, called a [codon](#).

See also: [Transcription](#), [Translation Overview](#) (from Chapter 27), [Nucleotides](#), [Proteins](#)

INTERNET LINKS:

1. [DNA and Protein Pages](#)
 2. [Translation Movie](#)
-

Figure 4.22: The basic principle of translation.

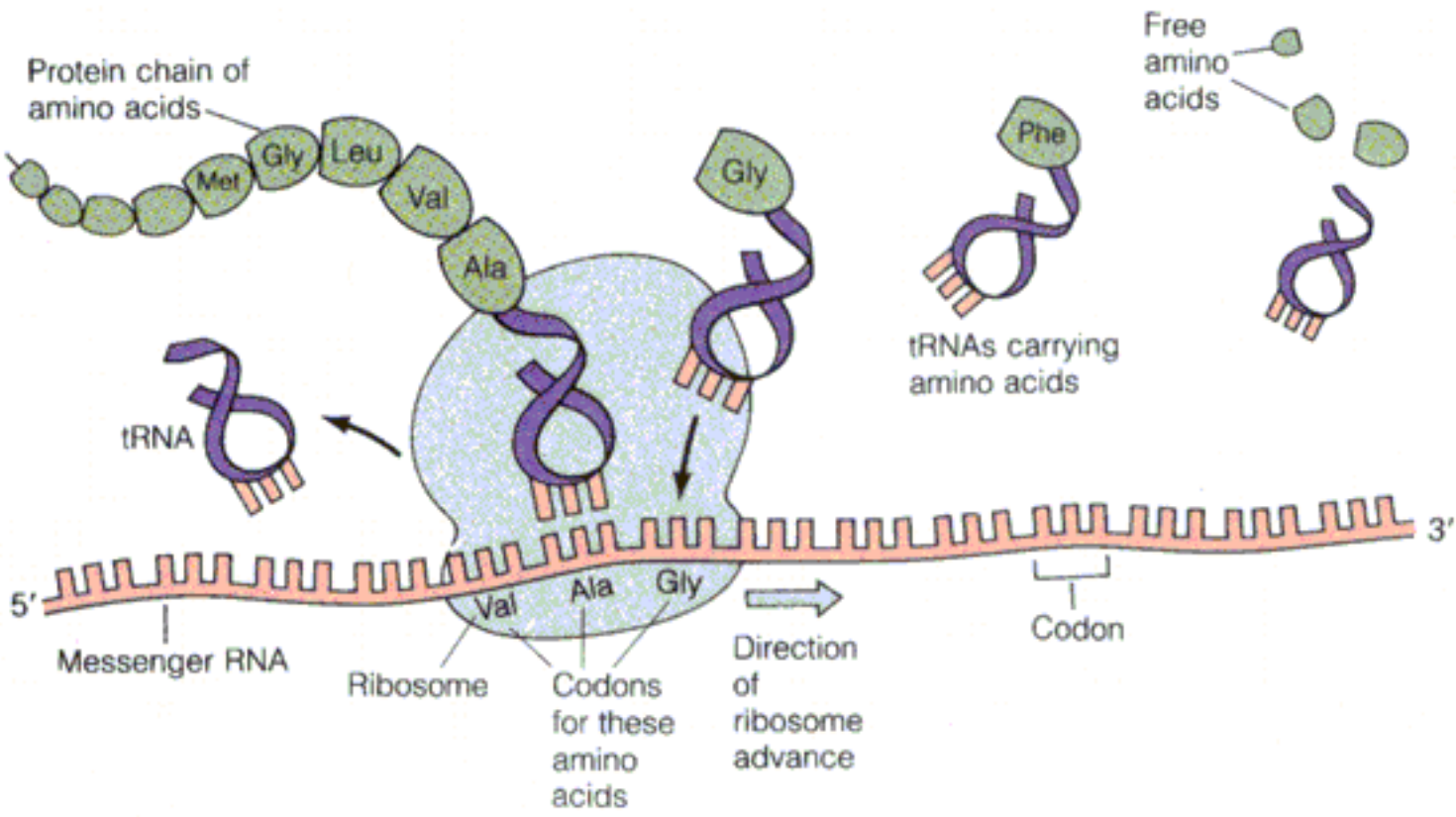

Transfer RNAs (tRNAs)

tRNAs are **RNA** molecules that provide the means of translating the genetic code. One end of the **tRNA** contains a three nucleotide sequence called the anticodon loop that is complementary to the codon of the mRNA. The other end of the **tRNA** is covalently attached to a specific amino acid. Since the amino acid carried by a **tRNA** is specific for each anticodon and each **anticodon** is complementary to the **codons** in **mRNA**, the **tRNA** provide the link between nucleic acid sequence and **amino acid** sequence for a protein during **translation**. This process, which occurs on **ribosomes**, incorporates a sequence of amino acids corresponding to the sequential series of codons in the mRNA.

See also: [Structure of tRNAs](#), [Figure 27.6](#), [Figure 5.20](#), [Figure 4.27](#), [Figure 4.20](#), , [Translation Overview](#) (from Chapter 27), [Figure 27.11](#), [Stringent Response](#), [Posttranscriptional Processing of rRNA and tRNA](#)

INTERNET LINKS:

1. [Small RNA Database](#)
 2. [The RNA World](#)
 3. [RNA Modification Database](#)
 4. [tRNA Sequence Database](#)
-

Anticodon



An **anticodon** is a sequence of three nucleotides in a transfer RNA (**tRNA**) that is complementary to a **codon** of messenger RNA (**mRNA**). The relationship between codons and the **amino acids** they code for is called the **genetic code**. The process of converting mRNA sequence information to the amino acid sequence of a protein is called **translation**.

See also: [Table 4.5](#), [Ribosomes](#), [Nucleotides](#)

Codons

The term **codon** refers to a sequence of three [nucleotides](#) in a messenger RNA ([mRNA](#)) that specifies the incorporation of a specific [amino acid](#) into a protein. The relationship between **codons** and the amino acids they code for is called the [genetic code](#). The process of converting mRNA sequence information to the amino acid sequence of a protein is called [translation](#). An [anticodon](#) is a complementary 3 base sequence in transfer RNA ([tRNA](#)).

Not all **codons** are used with equal frequency. In fact, there is a considerable amount of variation in the patterns of **codon** usage between different organisms.

See also: [Table 4.5](#), [Figure 27.3](#), [Ribosomes](#)

INTERNET LINKS:

1. [Codon Usage Database](#)
 2. [Transcription/Translation Summary](#)
-

Transcription

DNA contains the genetic information in cells, but proteins are not made directly from DNA. Instead, complementary **RNA** molecules must first be made from the DNA. The process of making RNA from DNA is called **transcription**. As shown schematically in **Figure 4.21**, **transcription** requires an enzyme called **RNA polymerase**.

The base pairing rules for making RNA from DNA are the following:

1. **T** in DNA is transcribed as **A** in RNA
2. **G** in DNA is transcribed as **C** in RNA
3. **A** in DNA is transcribed as **U** in RNA
4. **C** in DNA is transcribed as **G** in RNA

See also: [Nucleoside and Nucleotide Naming](#), [mRNA](#), [Background on Transcription](#) (from Chapter 26)

INTERNET LINK: [RNA Transcription and Processing](#)

Figure 4.21: The basic principle of transcription.

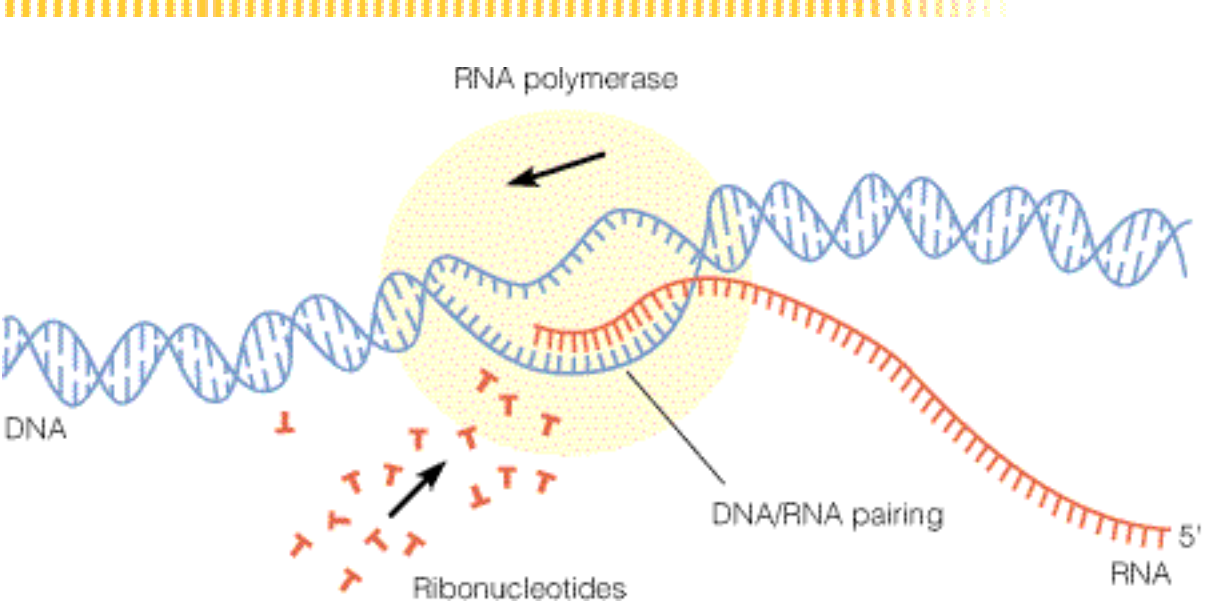

Structure of RNA Polymerase

Subunits - *E. coli* **RNA polymerase** is a multi-subunit protein. The five distinct polypeptide subunits of *E. coli* **RNA polymerase** are summarized in [Table 26.1](#). Two copies of the α subunit are present, along with one each of β , β' , σ , and ω , giving an Mr of about 450,000 for the holoenzyme. The subunit ω may be involved in regulation, but its precise role is not yet clear. It is not required for the reconstitution of active enzyme.

Subunit β is the target for **rifampicin** inhibition and β also plays a role in transcription initiation. β is the subunit with the catalytic site for chain elongation.

The σ subunit plays an important role in directing RNA polymerase to bind to template at the proper site for initiation--the promoter site--and to select the correct strand for transcription. The addition of σ to core polymerase reduces the affinity of the enzyme for nonpromoter sites by about 10^4 , thereby increasing the enzyme's specificity for binding to promoters. In at least some cases, gene expression is regulated by having core polymerase interact with different forms of σ , which would in turn direct the holoenzyme to different promoters.

Prokaryotic/eukaryotic RNA polymerases - **RNA polymerases** from different prokaryotic sources are remarkably similar in subunit size and composition. Eukaryotic **RNA polymerases** have much more complex and diverse subunit structures.

T7 RNA polymerase - Not all **RNA polymerases** in prokaryotic systems have multiple subunits. The best-known exception is **RNA polymerase** specified by bacteriophage T7. The left-hand 20% of the chromosome of its linear genome (as usually drawn) is transcribed early in infection by *E. coli* **RNA polymerase**. One of these early gene products is a virus-specified **RNA polymerase**. This single-subunit enzyme (Mr = 98,000) responds to different DNA control sequences and is responsible for all T7 transcription late in infection.

Recent crystallographic analysis of **T7 RNA polymerase** shows a DNA-binding domain similar to the "hand" structure seen in DNA polymerases, with a palm, fingers, and thumb that wrap about the DNA template

See also: [RNA Polymerases](#), [Interactions with Promoters](#), [Initiation and Elongation](#), [Factor-Independent Termination of Transcription](#), [Factor-Dependent Termination of Transcription](#)

INTERNET LINKS:

1. Regulation of Transcription by RNA Polymerase II

2. RNA Polymerase and GreA 3D Structures

Table 26.1



Subunit	M_r	Number per Enzyme Molecule	Function
α	36,500	2	Chain initiation, interaction with regulatory proteins and upstream promoter elements
β	151,000	1	Chain initiation and elongation
β'	155,000	1	DNA binding
σ	70,000 ^a	1	Promoter recognition
ω	11,000	1	Unknown

^a The 70-kDa σ subunit is one of several alternative σ subunits.

Interactions with Promoters

The overall process of transcription initiation and elongation is summarized in [Figure 26.6](#). The first step in transcription is binding of [RNA polymerase](#) to DNA, followed by migration to an initiation DNA site called the promoter.

1. RNA polymerase finds promoters by a search process ([Figure 26.6](#), step 1), in which the holoenzyme binds nonspecifically to DNA, with low affinity, and then slides along the DNA, without dissociation from it, until it reaches a **promoter** sequence, to which it binds with much higher affinity. σ factor is essential for this search, because the core enzyme does not bind to promoters more tightly than to nonpromoter sites. Binding to DNA and then moving along it reduce the complexity of the search for the promoter from three dimensions to one, just as finding a house becomes simpler once you find the street upon which that house is located.

2. The initial encounter between RNA polymerase holoenzyme and a **promoter** generates a closed-**promoter** complex. Whereas DNA strands unwind later in transcription, no unwinding is detectable in a closed-**promoter** complex. This complex forms with a K_a between 10^6 and 10^9 M^{-1} at 0.1 M NaCl. Binding is primarily electrostatic, for K_a depends on ionic strength. The complex is relatively labile, dissociating with a half-life of about 10 seconds.

Footprinting studies (techniques that determine the region of DNA covered by a protein) show that polymerase contacts DNA from about nucleotide -55 to -5, where +1 represents the first DNA nucleotide to be transcribed.

3. RNA polymerase unwinds several base pairs of DNA, from about -10 to -1, giving an open-**promoter** complex, so-called because it binds DNA whose strands are open, or unwound. This highly temperature-dependent reaction occurs with half-times of about 15 seconds to 20 minutes, depending upon the structure of the promoter. The open-**promoter** complex is extremely stable; it is not easily disrupted by high ionic strength, and it forms with a K_a as high as 10^{14} M^{-1} . A Mg^{2+} -dependent isomerization next occurs, giving a modified form of the open- **promoter** complex with the unwound DNA region extending from -12 to +2. Analysis indicates that DNA bending in the **promoter** region accompanies the transition from a closed-promoter to an open-**promoter** complex ([Figure 26.8](#)).

See also: [Initiation and Elongation](#), [Promoter Organization](#)

Figure 26.6: Initiation and elongation steps of transcription by bacterial RNA polymerase.

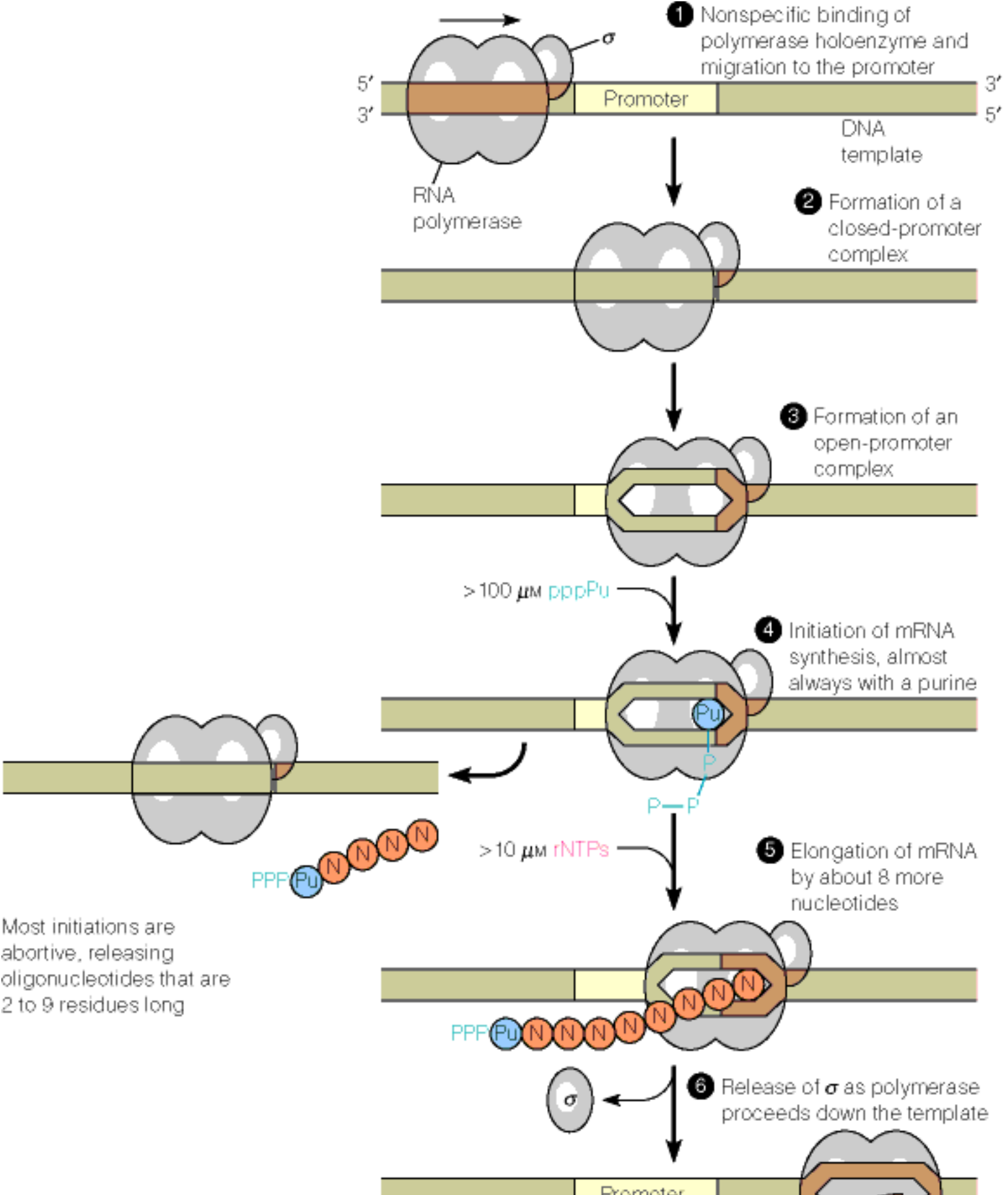

Most initiations are abortive, releasing oligonucleotides that are 2 to 9 residues long

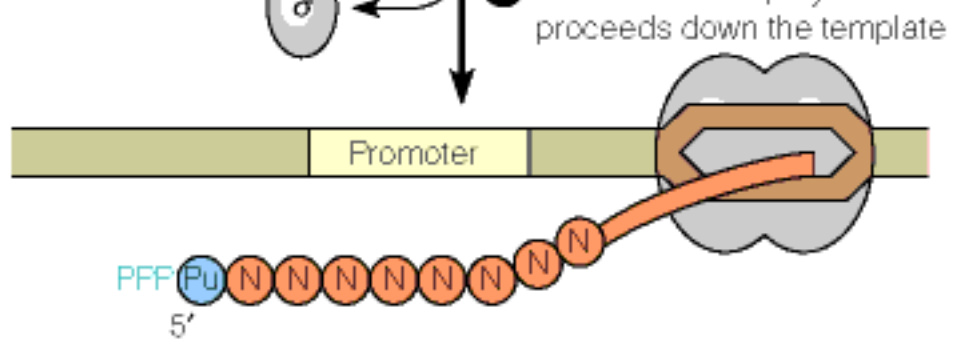
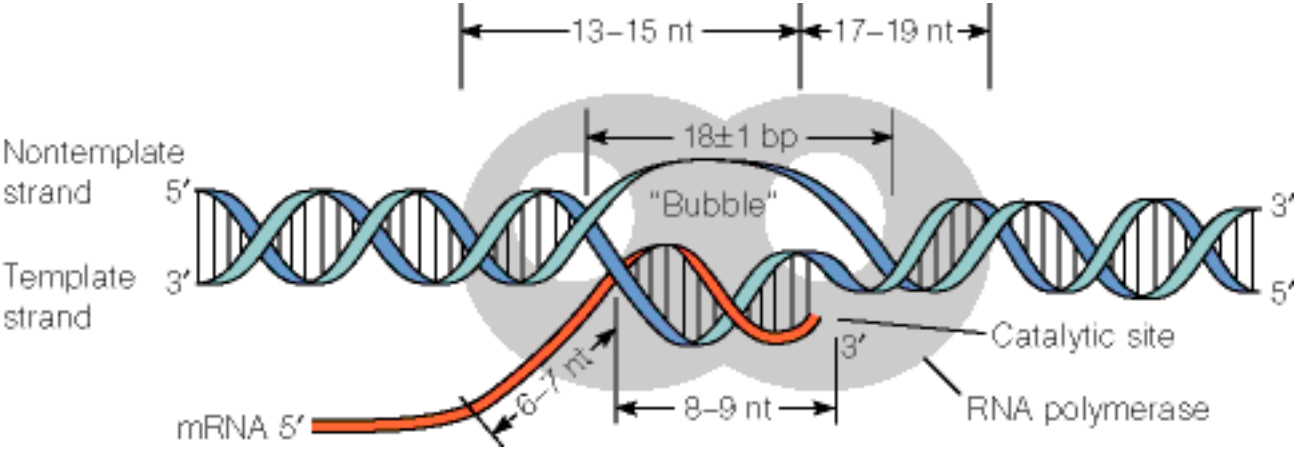

Figure 26.8: The transcription bubble.



Initiation and Elongation

Initiation - After **RNA polymerase** has bound to a promoter and formed an open-promoter complex, the enzyme is ready to initiate synthesis of an RNA chain. One nucleoside triphosphate binding site on RNA polymerase is used during elongation. It binds any of the four common ribonucleoside triphosphates (rNTPs). Another binding site is used for initiation. It binds **ATP** and **GTP** preferentially. Thus, most **mRNAs** have a **purine** at the 5' end.

1. Chain growth begins with binding of the template-specified rNTP at the initiation-specific site of **RNA polymerase** (**Figure 26.6**, step 4),
2. The next nucleotide binds at the elongation-specific site.
3. Nucleophilic attack by the 3' hydroxyl of the first nucleotide on the α (inner) phosphorus of the second nucleotide generates the first phosphodiester bond and leaves an intact triphosphate moiety at the 5' position of the first nucleotide.

Most initiations are abortive, with release of oligonucleotides 2 to 9 residues long. It is not yet clear why this happens.

σ and elongation - During transcription of the first 10 nucleotides, the σ subunit dissociates from the transcription complex, and the remainder of the transcription process is catalyzed by the core polymerase (**Figure 26.6**, steps 5 and 6). Once σ has dissociated, the elongation complex becomes quite stable. Transcription, as studied in vitro, can no longer be inhibited by adding **rifampicin** after this point, and virtually all transcription events proceed to completion.

Unwinding and rewinding - During elongation (**Figure 26.6**, steps 5 and 6), the core enzyme moves along the duplex DNA template and simultaneously unwinds the DNA, exposing a single-strand template for base pairing with incoming nucleotides and with the nascent transcript (the most recently synthesized RNA). It also rewinds the template behind the 3' end of the growing RNA chain. **Figure 26.9** shows interactions in the transcription elongation complex. A view of transcriptional elongation is represented in **Figure 26.8**. In the model shown in **Figure 26.8**, about 18 base pairs of DNA are unwound to form a moving "transcription bubble." As one base pair becomes unwound in advance of the 3' end of the nascent RNA strand, one base pair becomes rewound near the trailing end of the RNA polymerase molecule. About 8 base pairs of the 3' end of the nascent transcript are hybridized to the template DNA strand.

Irregular movement - RNA polymerase often advances through DNA discontinuously, holding its position for several cycles of nucleotide addition and then jumping forward by several base pairs along

the template. RNA polymerase "pauses" when it reaches DNA sequences that are difficult to transcribe in vitro, often sitting at the same site for several minutes before transcription is resumed. At such sites, RNA polymerase often translocates backward, and in the process the 3' end of the nascent transcript is displaced from the catalytic site of the enzyme. When this happens, a 3' "tail," is created which may be several nucleotides long and is not base-paired to the template, protruding downstream of the enzyme ([Figure 26.10](#)). In order for transcription to resume, the 3' end of the RNA must be positioned in the active site of the RNA polymerase. This is evidently the main function of the RNA 3' cleavage reactions catalyzed by the GreA and GreB proteins, which have been shown to stimulate a transcript cleavage activity intrinsic to the polymerase. These observations suggest that RNA polymerase movement generally moves forward until one of these special sequences is reached, or perhaps, until a transcription insertion error generates a DNA-RNA mispairing that weakens the hybrid and allows backtracking.

See also: [Promoter Organization](#), [Interactions with Promoters](#), [Factor-Independent Termination of Transcription](#), [Factor-Dependent Termination of Transcription](#)

INTERNET LINKS:

1. [Regulation of Transcription by RNA Polymerase II](#)
 2. [RNA Polymerase and GreA 3D Structures](#)
 3. [Fundamental Mechanisms in the Initiation of Transcription](#)
-

Succinyl-CoA Synthetase

Succinyl-CoA synthetase (also called **succinate thiokinase**) is an enzyme of the **citric acid cycle** that catalyzes the reaction below:



Note that the enzyme is named for the **reverse** reaction. Plants and bacteria form **ATP** from **ADP** instead of using **GDP/GTP**. GTP and ATP can be interconverted in the reaction catalyzed by **NDPK**:

Next enzyme of citric acid cycle / **Previous** enzyme of citric acid cycle

See also: **Citric Acid Cycle Enzymes**, **Figure 14.3**, **Table 14.1**, **Substrate Level Phosphorylation**

INTERNET LINK: **Citric Acid Cycle**

Citric Acid Cycle Reactions

The **citric acid cycle** is a central metabolic pathway which generates NADH and FADH₂ for use in electron transport. It also produces GTP via substrate-level phosphorylation. Many metabolic processes use intermediates of the **citric acid cycle** in their pathways. The cyclic process is generally considered to "begin" with addition of acetyl-CoA to oxaloacetate to form citrate. Remember, however, that the pathway *is* cyclic.

Reaction Summary of the Citric Acid Cycle:

1. <u>Acetyl-CoA</u> + <u>Oxaloacetate</u> + H ₂ O \rightleftharpoons <u>Citrate</u> + <u>CoASH</u> + H ⁺	Enzyme: <u>Citrate Synthase</u> $\Delta G^{\circ\prime} = -32.2 \text{ kJ/mol}$
2. <u>Citrate</u> \rightleftharpoons <u>cis-Aconitate</u> + H ₂ O \rightleftharpoons <u>Isocitrate</u>	Enzyme: <u>Aconitase</u> $\Delta G^{\circ\prime} = +6.3 \text{ kJ/mol}$
3. <u>Isocitrate</u> + <u>NAD</u> ⁺ \rightleftharpoons α - <u>Ketoglutarate</u> + CO ₂ + <u>NADH</u>	Enzyme: <u>Isocitrate Dehydrogenase</u> $\Delta G^{\circ\prime} = -20.9 \text{ kJ/mol}$
4. α - <u>Ketoglutarate</u> + <u>NAD</u> ⁺ + <u>CoASH</u> \rightleftharpoons <u>Succinyl-CoA</u> + CO ₂ + <u>NADH</u>	Enzyme: α - <u>Ketoglutarate Dehydrogenase Complex</u> $\Delta G^{\circ\prime} = -33.5 \text{ kJ/mol}$
5. <u>Succinyl-CoA</u> + Pi + GDP \rightleftharpoons <u>Succinate</u> + <u>GTP</u> + <u>CoASH</u>	Enzyme: <u>Succinyl-CoA Synthetase</u> $\Delta G^{\circ\prime} = -2.9 \text{ kJ/mol}$
6. <u>Succinate</u> + <u>FAD</u> (enzyme bound) \rightleftharpoons <u>Fumarate</u> + <u>FADH</u> ₂	Enzyme: <u>Succinate Dehydrogenase</u>

$$\Delta G^{\circ'} = 0 \text{ kJ/mol}$$

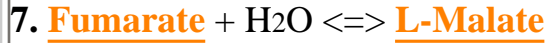

Enzyme: **Fumarate Hydratase**

$$\Delta G^{\circ'} = -3.8 \text{ kJ/mol}$$



Enzyme: **Malate Dehydrogenase**

$$\Delta G^{\circ'} = +29.7 \text{ kJ/mol}$$

See also: **Table 14.1**, **Figure 14.3**, **Electron Transport**

INTERNET LINK: **Citric Acid Cycle**

Acetyl-CoA

Acetyl-CoA is an "activated" two carbon compound found in many central metabolic pathways, including the citric acid cycle, the glyoxylate cycle, fatty acid synthesis, fatty acid oxidation, isoprene metabolism, amino sugar metabolism, ketone body metabolism, and cholesterol biosynthesis. The term "activated" used to describe the compound comes partly from the nature of the high energy thioester bond in the molecule with a $\Delta G^{\circ\prime}$ of -31.5 kJ/mol. **Acetyl-CoA** is one of the most ubiquitous metabolites in biological systems.

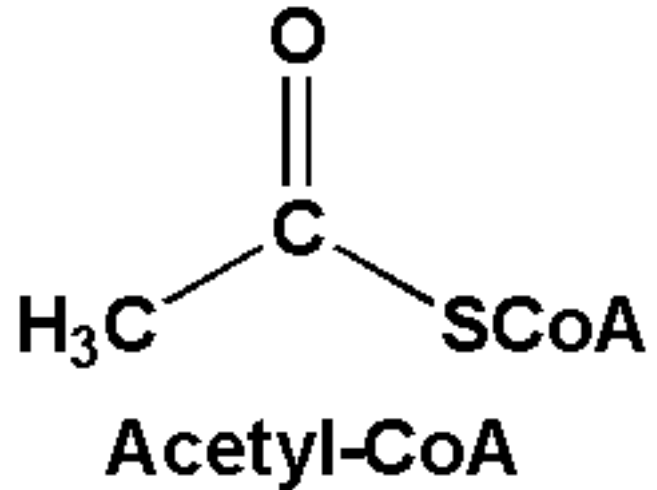

Acetyl-CoA is also an allosteric regulator of the enzymes pyruvate kinase (turns it off), pyruvate carboxylase (turns it on).

See also: [Coenzyme A](#), [Citric Acid Cycle](#), [Pyruvate Kinase](#), [Pyruvate Carboxylase](#)

INTERNET LINKS:

1. [Glyoxylate Cycle Metabolism](#)
 2. [Citric Acid Cycle](#)
-

Coenzyme A (CoA or CoASH)

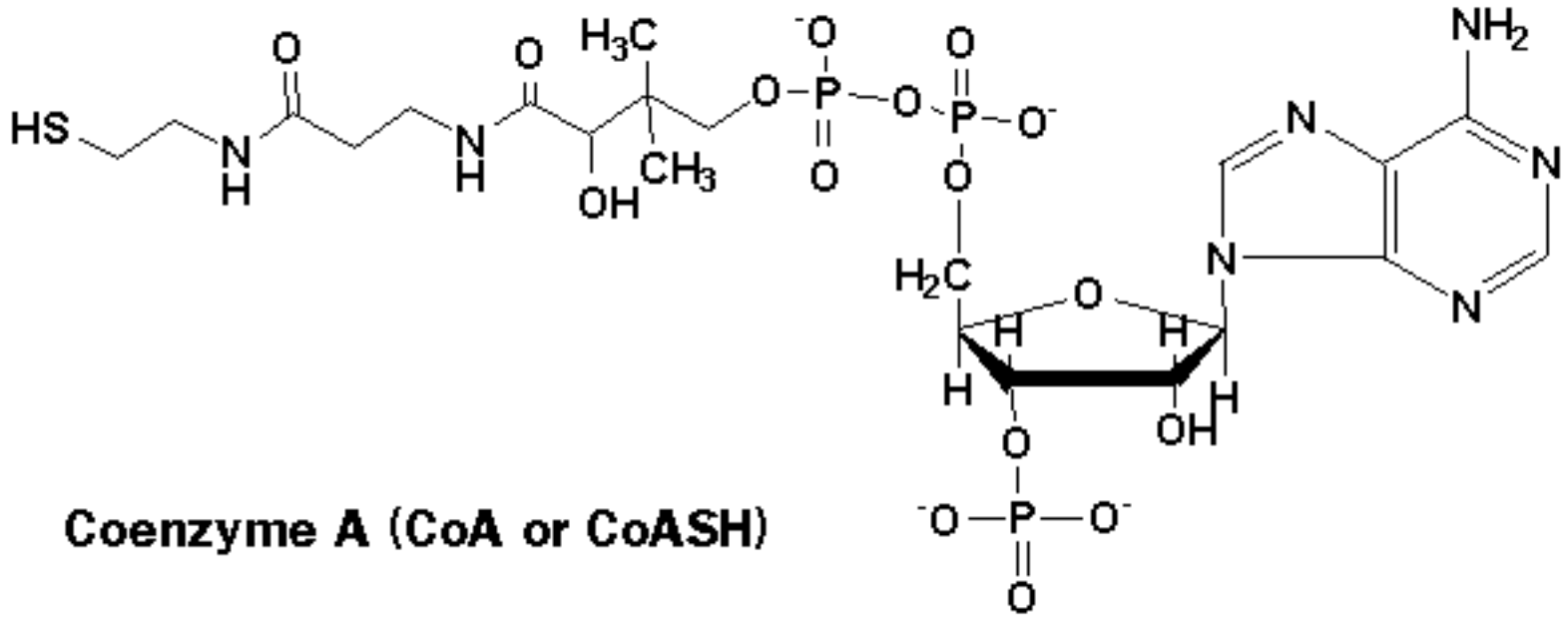

Coenzyme A (CoA or CoASH)

Coenzyme A (A for acyl) participates in activation of acyl groups in general, including the acetyl group derived from **pyruvate**. The coenzyme is derived metabolically from **ATP**, the vitamin **pantothenic acid**, and **β -mercaptoethylamine** (**Figure 18.26**). A free thiol on the last moiety is the functionally significant part of the coenzyme molecule; the rest of the molecule provides enzyme binding sites. In acylated derivatives, such as **acetyl-coenzyme A**, the acyl group is linked to the thiol group to form an energy-rich thioester. The acylated forms of coenzyme A will be designated here as acyl-CoA, and the unacylated form as CoA-SH.

The energy-rich nature of thioesters, as compared with ordinary esters, is related primarily to resonance stabilization (**Figure 14.9**). Most esters can resonate between two forms (**Figure 14.9**). Stabilization involves Pi-electron overlap, giving partial double-bond character to the C-O link. In thioesters, the larger atomic size of S (as compared with O) reduces the Pi-electron overlap between C and S, so that the C-S structure does not contribute significantly to resonance stabilization. Thus, the thioester is destabilized relative to an ester, so that its ΔG of hydrolysis is increased.

The lack of double-bond character in the C-S bond of acyl-CoAs makes this bond weaker than the corresponding C-O bond in ordinary esters, in turn making the thioalkoxide ion (R-S⁻) a good leaving group in nucleophilic displacement reactions. Thus, the acyl group is readily transferred to other metabolites, as occurs, in fact, in the first reaction of the citric acid cycle.

Common metabolic reactions involving **Coenzyme A** are shown below.

- Acetate** + **CoASH** + ATP \rightleftharpoons **Acetyl-CoA** + **AMP** + P_i (catalyzed by **Acetate Thiokinase**).
- Pyruvate** + **NAD⁺** + **CoASH** \rightleftharpoons **Acetyl-CoA** + **NADH** + CO₂ (catalyzed by **Pyruvate**

Dehydrogenase).

3. 3-Ketoacyl-CoA + CoASH \rightleftharpoons Acyl-CoA (less 2 carbons) + Acetyl-CoA (catalyzed by Thiolase).
4. Malonyl-CoA + ACP \rightleftharpoons Malonyl-ACP + CoASH (catalyzed by Malonyl-CoA-ACP Transacylase)
5. Acetyl-CoA + ACP \rightleftharpoons Acetyl-ACP + CoASH (catalyzed by Acetyl-CoA-ACP Transacylase)
6. Acyl-CoA + Carnitine \rightleftharpoons Acyl-Carnitine + CoASH (catalyzed by Carnitine Acyltransferase I)
7. Acyl-Carnitine + CoASH \rightleftharpoons Acyl-CoA + Carnitine (catalyzed by Carnitine Acyltransferase II)

See also: Pyrimidine Catabolism

Pantothenic Acid

Pantothenic acid is a vitamin that forms an essential part of the acyl-carrier moiety, coenzyme A.

See also: [Coenzyme A](#)

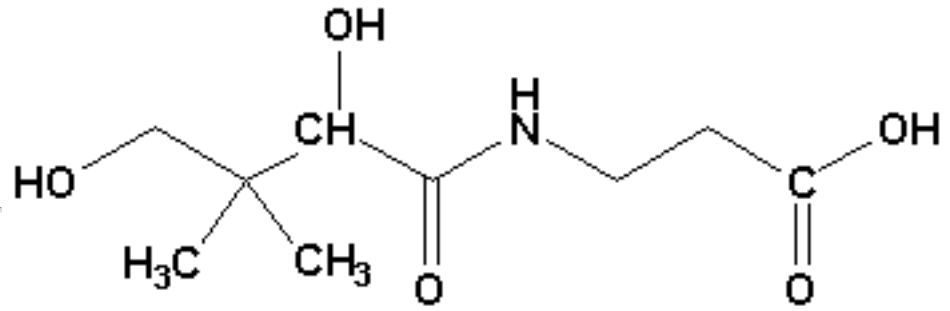

Pantothenic Acid

β -Mercaptoethylamine

β -Mercaptoethylamine is a structural part of coenzyme A to which the acyl groups are attached (see [coenzyme A](#)).

See also: [Acyl Groups](#)

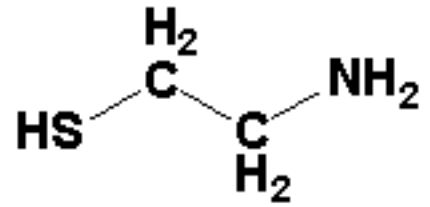

Beta mercaptoethylamine

Acyl Groups

Acyl groups refer to carbon chains derived from [fatty acids](#) or simple organic acids, such as [acetic acid](#). Examples of fatty acid groups are shown in [Table 10.1](#). Coenzyme A is a common carrier of acyl groups in cells. [Fats](#), some proteins, glycolipids, and [sphingolipids](#) may all contain one or more **acyl groups**.

See also: [Coenzyme A](#), [Fatty Acids](#)

Fatty Acids

Fatty acids in the body arise either from biosynthesis from acetyl-CoA or from breakdown of fats and phospholipids. Free **fatty acids** are rarely found in the body. **Fatty acids** are transported in the blood complexed to serum albumin. **Fatty acids** can be saturated (no double bonds) or unsaturated (contain double bonds). Unsaturated **fatty acids** of biological origin predominantly contain *cis* double bonds. Mammals are unable to synthesize some **fatty acids**, making these **fatty acids** essential components of their diet.

Common saturated fatty acids include [palmitic acid](#) and [stearic acid](#). Common unsaturated fatty acids include [oleic acid](#), [palmitoleic acid](#), [linoleic acid](#), [linolenic acid](#). The fatty acid, [arachidonic acid](#), is a precursor of the [prostaglandins](#).

See also: [Acetyl-CoA](#), [Fats](#), [Albumin](#), [Fatty Acid Activation](#), [\$\beta\$ Oxidation of Saturated Fatty Acids](#), [Oxidation of Unsaturated Fatty Acids](#), [Fatty Acid Biosynthesis Strategy](#), [Palmitate Synthesis from Acetyl-CoA](#), [Fatty Acid Desaturation](#), [Essential Fatty Acids](#), [Control of Fatty Acid Synthesis](#), [Molecular Structures and Properties of Lipids](#) (from Chapter 10)

Palmitic Acid (Palmitate, n-Hexadecanoic Acid)

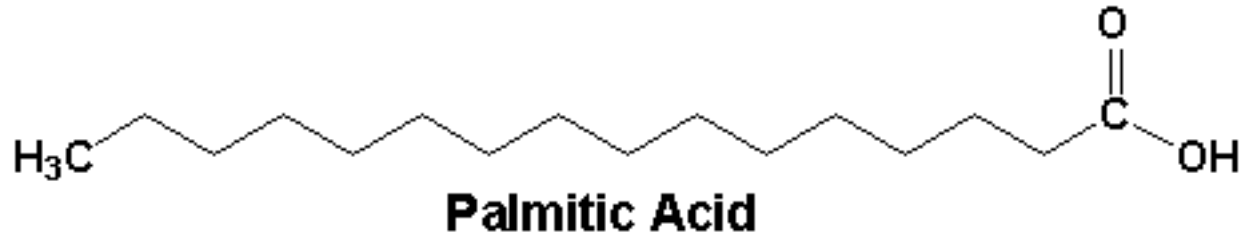

Palmitic acid is a 16-carbon saturated fatty acid that is the end product of synthesis of the fatty acid synthase complex. **Palmitic acid** (as [palmitoyl-CoA](#)) is a starting substrate for synthesis of both longer chain fatty acids and unsaturated fatty acids.

Palmitic acid (in the form of [palmitoyl-CoA](#)) is also a precursor of the [sphingolipids](#) ([Figure 19.12](#)).

See also: [Fatty Acids](#), [Table 10.1](#), [Synthesis of Long Chain Fatty Acids](#), [Fatty Acid Desaturation](#), [Fatty Acid Synthase](#), [Palmitate Synthesis from Acetyl-CoA](#)

Palmitoyl-CoA

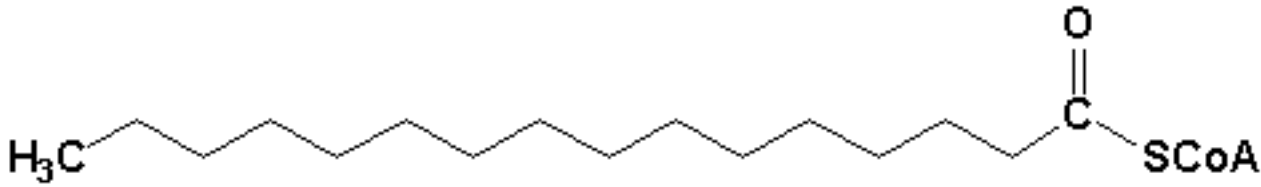

Palmitoyl-CoA

Palmitoyl-CoA is the product of synthesis catalyzed by the [fatty acid synthase](#) complex. Cleavage of the thioester bond of the CoA group yields [palmitic acid](#). Palmitoyl-CoA is also a precursor of the sphingolipids (see [here](#))

See also: [Fatty Acids](#), [Table 10.1](#), [Synthesis of Long Chain Fatty Acids](#), [Fatty Acid Desaturation](#), [Palmitate Synthesis from Acetyl-CoA](#), [Biosynthesis of Sphingolipids](#), [3-Ketosphinganine](#)

INTERNET LINKS:

1. [Sphingolipid Metabolism](#)
 2. [Sphingoglycolipid Metabolism](#)
-

Fatty Acid Synthase

Fatty acid synthase is the name of the complex of six enzymatic activities that performs biosynthesis of fatty acids in cells. The enzyme is composed of two multifunctional polypeptide chains, which contain the enzymatic activities below:

[Acetyl-CoA-ACP Transacylase](#)

[\$\beta\$ -Ketoacyl-ACP Synthase](#)

[Malonyl-CoA-ACP Transacylase](#)

[\$\beta\$ -Ketoacyl-ACP Reductase](#)

[3-Hydroxylacyl-ACP Dehydrogenase](#)

[Enoyl-ACP Reductase](#)

See also: [Palmitate Biosynthesis from Acetyl-CoA](#), [Fatty Acid Biosynthesis Strategy](#), [Synthesis of Long Chain Fatty Acids](#), [Figure 18.29](#), [Figure 18.30](#), [Fatty Acids](#)

INTERNET LINK: [Fatty Acid Biosynthesis](#)

Acetyl-CoA-ACP Transacylase

Acetyl-CoA-ACP Transacylase is an enzyme of fatty acid biosynthesis that catalyzes the transfer of acyl carrier protein (ACP) to acetyl-CoA in the reaction below ([Figure 18.24](#)). Acetyl-ACP is the initial two carbon unit onto which the initial malonyl-ACP is added to form β -ketoacyl-ACP.



See also: [Fatty Acid Biosynthesis](#), [Fatty Acid Synthase](#)

INTERNET LINK: [Fatty Acid Biosynthesis](#)

Figure 18.24: The first three reactions in each addition cycle of fatty acid synthesis.

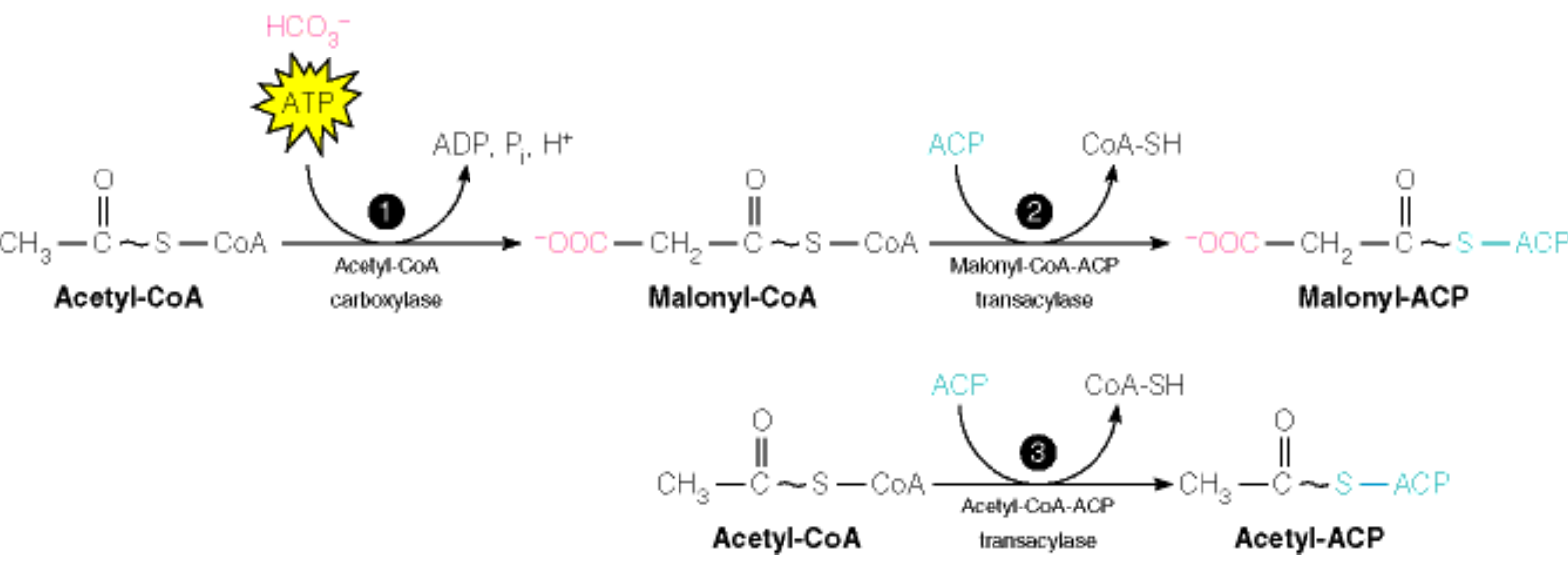

Oxaloacetate (OAA)

OAA is an intermediate in several important pathways, including [gluconeogenesis](#), [citric acid cycle](#), [glyoxylate cycle](#), [urea cycle](#), and amino acid metabolism (see [here](#)).

Oxaloacetate is formed in the glyoxylate, citric acid, and urea cycles as a result of catalysis by [malate dehydrogenase](#):



In the reaction, hydrogens are transferred to NAD^+ , forming $\text{NADH} + \text{H}^+$.

Oxaloacetate can be converted in the citric acid and glyoxylate cycles to citrate by addition of [acetyl-CoA](#) by the enzyme [citrate synthase](#). In the urea cycle, **oxaloacetate** is transaminated by a transaminase to form aspartic acid.

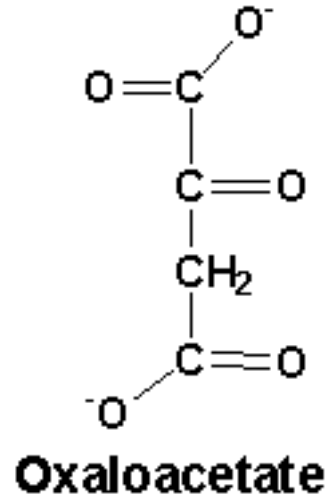

Some of the enzymes that act on **OAA** include the following:

[Pyruvate Carboxylase](#)

[PEPCK](#)

[Citrate Synthase](#)

[Malate Dehydrogenase](#)

See also: [Malate/Aspartate Shuttle](#), [Transamination in Amino Acid Metabolism](#) (from Chapter 20), [Citric Acid Cycle Intermediates in Amino Acid Metabolism](#) (from Chapter 21)

INTERNET LINKS:

1. [Glyoxylate Cycle Metabolism](#)
2. [Citric Acid Cycle](#)

3. Urea Cycle and Metabolism of Amino Groups

Glyoxylate Cycle

Plants and some bacteria contain two enzymes (**isocitrate lyase** and **malate synthase**) that enable them to synthesize sugars by using the **glyoxylate cycle**, a variant form of the citric acid cycle. Notice in **Figure 14.20** that the **glyoxylate cycle** uses some of the same enzymes as the citric acid cycle, but that the steps in which decarboxylations occur are bypassed. One of the intermediates in the bypass is glyoxylate, which gives the cycle its name.

Because the decarboxylation reactions are bypassed, the two carbons lost during each turn of the citric acid cycle are retained in the **glyoxylate cycle**. In fact, the **glyoxylate cycle** results in the net synthesis of oxaloacetate, a four-carbon molecule, because each turn of the cycle incorporates two molecules of acetyl-CoA. The oxaloacetate can then be used for other purposes, such as gluconeogenesis. Animal cells can use oxaloacetate from the citric acid cycle for gluconeogenesis too, but there is no net synthesis of glucose from acetyl-CoA because for every carbon introduced via acetyl-CoA, one is lost via CO₂.

The **glyoxylate cycle** also allows many microorganisms (i.e., many bacteria, fungi, protozoans, and algae) to metabolize two-carbon substrates such as acetate. *E. coli* can be grown in a medium that provides acetate as the sole carbon source. *E. coli* synthesizes acetyl-CoA, then uses it for energy production (via the citric acid cycle) and for synthesis of gluconeogenic precursors (via the **glyoxylate cycle**).

Reaction Summary of the Glyoxylate Cycle:

1. **Acetyl-CoA** + **Oxaloacetate** + H₂O \rightleftharpoons **Citrate** + **CoASH** + H⁺ (catalyzed by **Citrate Synthase**, $\Delta G^{\circ\prime} = -32.2$ kJ/mol)
2. **Citrate** \rightleftharpoons **cis-Aconitate** + H₂O \rightleftharpoons **Isocitrate** (catalyzed by **Aconitase**, $\Delta G^{\circ\prime} = +6.3$ kJ/mol)
3. **Isocitrate** \rightleftharpoons **Succinate** + **Glyoxylate** (catalyzed by **Isocitrate Lyase**)
4. **Glyoxylate** + **Acetyl-CoA** \rightleftharpoons **L-Malate** + **CoASH** + H⁺ (catalyzed by **Malate Synthase**)
5. **Succinate** + **FAD** (enzyme bound) \rightleftharpoons **Fumarate** + **FADH₂** (enzyme bound)
(catalyzed by **Succinate Dehydrogenase**, $\Delta G^{\circ\prime} = 0$)
6. **Fumarate** + H₂O \rightleftharpoons **L-Malate** (catalyzed by **Fumarate Hydratase**, $\Delta G^{\circ\prime} = -3.8$ kJ/mol)

7. L-Malate + NAD⁺ <=> Oxaloacetate + NADH + H⁺ (catalyzed by Malate Dehydrogenase, $\Delta G^{\circ\prime} = +29.7$ kJ/mol)

See also: Citric Acid Cycle Reactions, Gluconeogenesis

INTERNET LINK: Glyoxylate Cycle Metabolism

Isocitrate Lyase

Isocitrate lyase is an enzyme of the glyoxylate cycle that catalyzes the reaction below:



This enzyme, which is present in plants and bacteria, allows for net synthesis of **glucose** using a two-carbon source, such as **acetyl-CoA** from breakdown of fatty acids. Because animals do not have **isocitrate lyase**, they cannot synthesize glucose in net amounts from fat.

See also: [Glyoxylate Cycle](#), [Glyoxylate Cycle Enzymes](#), [Figure 14.20](#)

INTERNET LINK: [Glyoxylate Cycle Metabolism](#)

D-Isocitrate

D-Isocitrate is a [citric acid cycle](#) (and glyoxylate cycle) intermediate produced as a result of action of the enzyme aconitase on citrate. **Isocitrate** is converted to α -ketoglutarate by action of the enzyme isocitrate dehydrogenase

See also: [Glyoxylate Cycle](#), [Aconitase](#), [Citrate](#), [Isocitrate Dehydrogenase](#), [\$\alpha\$ -Ketoglutarate](#), [Fluorocitrate](#), [Citric Acid Cycle Intermediates](#), [Figure 14.3](#), [Table 14.1](#)

INTERNET LINKS:

1. [Glyoxylate Cycle Metabolism](#)
 2. [Citric Acid Cycle](#)
-

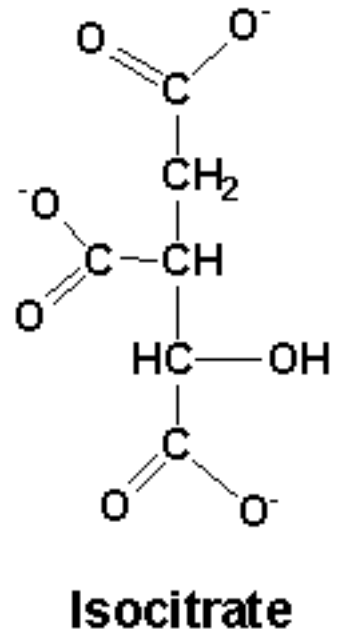

Aconitase

Aconitase is an enzyme of the citric acid cycle (and glyoxylate cycle) that catalyzes the reaction below ([reaction diagram](#)):



The reaction is interesting in that the starting compound, citrate, has an axis of symmetry, yet a stereospecific product, D-isocitrate, is produced. This arises from the fact that **aconitase** has an asymmetric binding site for citrate (see stereospecificity link below as well).

Aconitase is inhibited by [fluorocitrate](#).

[Next](#) enzyme of citric acid cycle / [Previous](#) enzyme of citric acid cycle

See also: [Citric Acid Cycle](#), [Glyoxylate Cycle Reactions](#), [Stereospecificity of Aconitase](#), [Enzymes of the Citric Acid Cycle](#), [Table 14.1](#)

INTERNET LINKS:

1. [Glyoxylate Cycle Metabolism](#)
 2. [Citric Acid Cycle](#)
-

Unnumbered Item

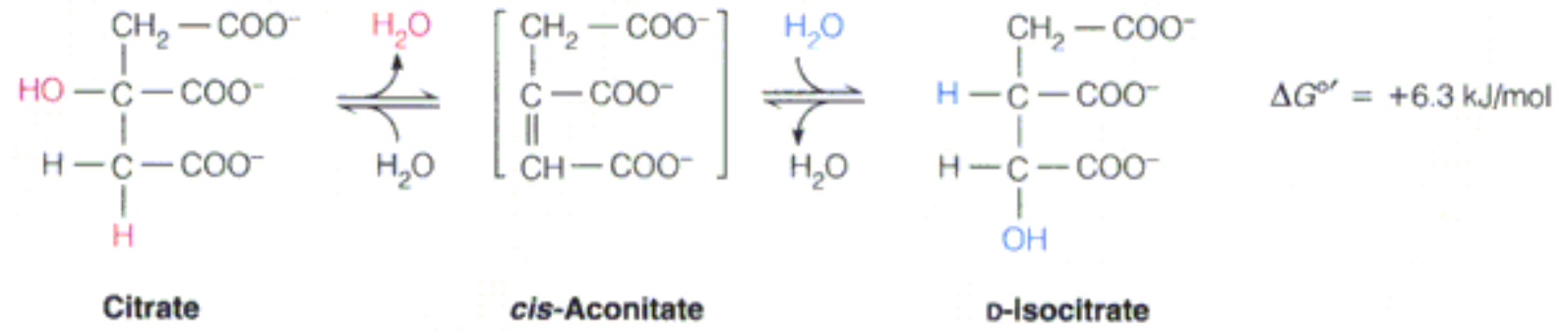

Citric Acid (Citrate)

Citrate is a citric acid cycle (and glyoxylate cycle) intermediate (reactions 1 and 2 below)

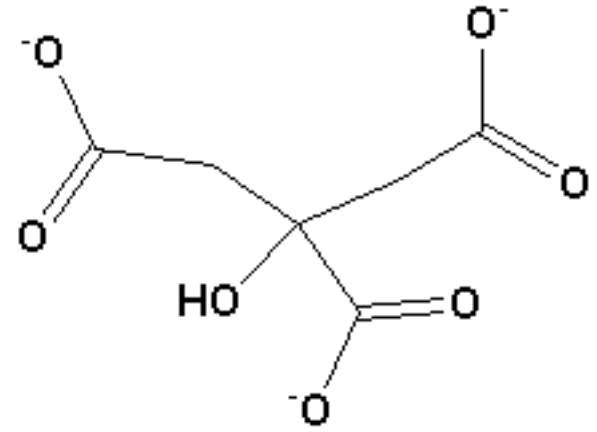

Citric Acid (Citrate)

1. Acetyl-CoA + Oxaloacetate \rightleftharpoons **Citrate** + CoASH (catalyzed by Citrate Synthase)
2. **Citrate** \rightleftharpoons cis-aconitate \rightleftharpoons D-Isocitrate (catalyzed by Aconitase)
3. **Citrate** + ATP + CoASH \rightleftharpoons Acetyl-CoA + Oxaloacetate + ADP + Pi (catalyzed by Citrate Lyase)

In the first reaction, citroyl-CoA is a transient intermediate and in the second reaction, cis-aconitate is a transient intermediate. **Citrate** is used in fatty acid biosynthesis to transport acetyl-CoA across the mitochondrial membrane to the cytoplasm (Figure 18.31). After release in the cytoplasm, reaction #3 occurs.

Citrate acts allosterically to stimulate polymerization of acetyl-CoA carboxylase (regulatory enzyme for fatty acid biosynthesis) and inhibits the glycolysis enzyme, phosphofruktokinase.

See also: Citric Acid Cycle, Glyoxylate Cycle

INTERNET LINKS:

1. Glyoxylate Cycle Metabolism
 2. Citric Acid Cycle
-

Urea Cycle

Ammonia is a universal participant in amino acid synthesis and degradation, but its accumulation has toxic consequences. Because terrestrial animals must conserve water, they convert ammonia to a form that can be excreted without large water losses. Birds, terrestrial reptiles, and insects convert most of their excess ammonia to **uric acid**, an oxidized purine. Most mammals excrete the bulk of their nitrogen as **urea**. See urea cycle reactions [here](#).

Urea is synthesized in mammals almost exclusively in the liver and then transported to the kidneys for excretion. The process that generates urea is called the urea cycle and is depicted in [Figure 20.13](#). The last step in the cycle is the hydrolytic cleavage of arginine to yield ornithine and one molecule of urea. Virtually all organisms use the reactions shown in [Figure 20.13](#) to synthesize **arginine** from **ornithine**, but they lack the **arginase** enzyme needed to make the pathway cyclic. Only ureotelic organisms—those that excrete urea—contain arginase, so only ureotelic organisms can carry out the cyclic pathway.

The net reaction for one turn of the urea cycle is

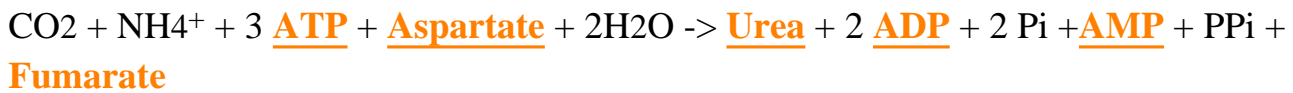

Because it takes 2 ATP to regenerate one ATP from one AMP, four high energy phosphates are consumed in each turn of the cycle. Thus, synthesis of urea is energetically expensive.

Reactions of the **urea cycle** occur in both the mitochondria and cytosol of liver cells. **Glutamate dehydrogenase**, the **citric acid cycle enzymes**, **carbamoyl phosphate synthetase I**, and **ornithine transcarbamoylase** are localized in the mitochondrion, whereas the rest of the cycle occurs in the cytosol. This means that ornithine must be transported into mitochondria, and citrulline must be exported to the cytosol, in order for the cycle to proceed.

Following synthesis, urea is transported in the bloodstream to the kidneys, which filter it for excretion. Measurements of blood urea nitrogen (BUN) levels provide a sensitive clinical test of kidney function, because filtration and removal of urea are impaired in cases of kidney malfunction. Analogously, blood ammonia measurements are a sensitive test of liver function.

See also: [Urea Cycle Reactions](#), [Urea](#), [Uric Acid](#), [The Nitrogen Cycle](#), [Utilization of Ammonia](#), [Metabolic Nitrogen Balance](#), [Amino Acid Degradation](#), [Ammonia Transport in the Body](#), [Citric Acid Cycle](#), [ATP as Free Energy Currency](#) (from Chapter 12)

INTERNET LINK: [Urea Cycle and Metabolism of Amino Groups](#)

Uric Acid

Ammonia is a universal participant in amino acid synthesis and degradation, but its accumulation has toxic consequences. Because terrestrial animals must conserve water, they convert ammonia to a form that can be excreted without large water losses. Birds, terrestrial reptiles, and insects convert most of their excess ammonia to **uric acid**, an oxidized purine. Most mammals excrete the bulk of their nitrogen as urea. See urea cycle reactions [here](#).

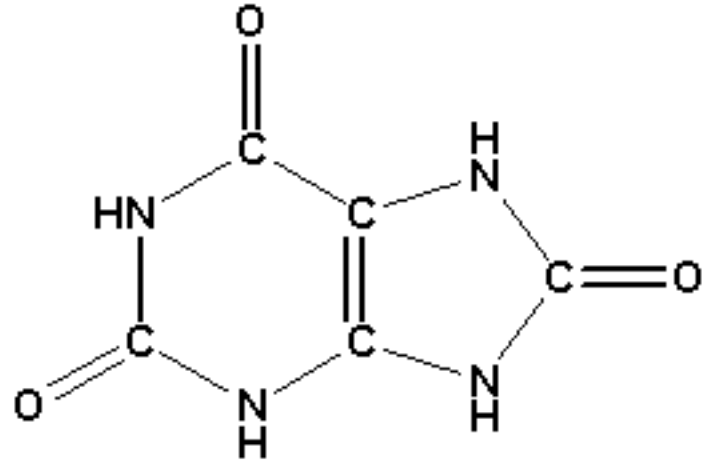

Uric Acid

Uric acid is an intermediate in purine nucleotide metabolism ([Figure 22.7](#)) and is quite insoluble in water. Consequently, increasing concentrations of it causes it to precipitate as crystals of sodium urate, and cause the painful condition of gout.

Uric acid also has antioxidant properties.

See also: [Urea Cycle Reactions](#), [Urea](#), [Antioxidants](#) (from Chapter 15), [Excessive Uric Acid in Purine Degradation](#) (from Chapter 22), [Purine Degradation](#) (from Chapter 22), [Pathways in Nucleotide Metabolism](#) (from Chapter 22), [HGPRT](#), [Hypoxanthine](#), [Xanthine Oxidase](#)

INTERNET LINK: [Purine Metabolism](#)

Urea Cycle Reactions

The **urea cycle**, as its name implies, is a cyclic pathway, but there is a point of entry of ammonium ion and an exit point of urea, which will be used below as the first and last reactions of the cycle. **Figure 20.13** depicts the figure-8 scheme of the pathway, which explains the reactions below that follow the reactions leading to urea.

Reaction	Enzyme
$\text{NH}_4^+ + \text{CO}_2 + 2 \text{ATP} \rightleftharpoons \text{Carbamoyl Phosphate} + 2 \text{ADP} + \text{P}_i$	<u>Carbamoyl Phosphate Synthetase</u>
$\text{Carbamoyl Phosphate} + \text{Ornithine} \rightleftharpoons \text{Citrulline} + \text{P}_i$	<u>Ornithine Transcarbamoylase</u>
$\text{Citrulline} + \text{Aspartate} + \text{ATP} \rightleftharpoons \text{Argininosuccinate} + \text{AMP} + \text{PP}_i$	<u>Argininosuccinate Synthetase</u>
$\text{Argininosuccinate} \rightleftharpoons \text{Arginine} + \text{Fumarate}$	<u>Argininosuccinase</u>
$\text{Arginine} + \text{H}_2\text{O} \rightleftharpoons \text{Urea} + \text{Ornithine}$	<u>Arginase</u>
$\text{Fumarate} + \text{H}_2\text{O} \rightleftharpoons \text{Malate}$	<u>Fumarate Hydratase</u>
$\text{Malate} + \text{NAD}^+ \rightleftharpoons \text{Oxaloacetate} + \text{NADH} + \text{H}^+$	<u>Malate Dehydrogenase</u>
$\text{Oxaloacetate} + \text{Glutamate} \rightleftharpoons \text{Aspartate} + \alpha\text{-Ketoglutarate}$	<u>Transaminase</u>
$\alpha\text{-Ketoglutarate} + \text{NH}_4^+ + \text{NADH} + \text{H}^+ \rightleftharpoons \text{Glutamate} + \text{H}_2\text{O} + \text{NAD}^+$	<u>Glutamate dehydrogenase</u>

See also: [Urea Cycle Description](#)

INTERNET LINK: [Urea Cycle and Metabolism of Amino Groups](#)

Figure 20.13: The Krebs-Henseleit urea cycle.

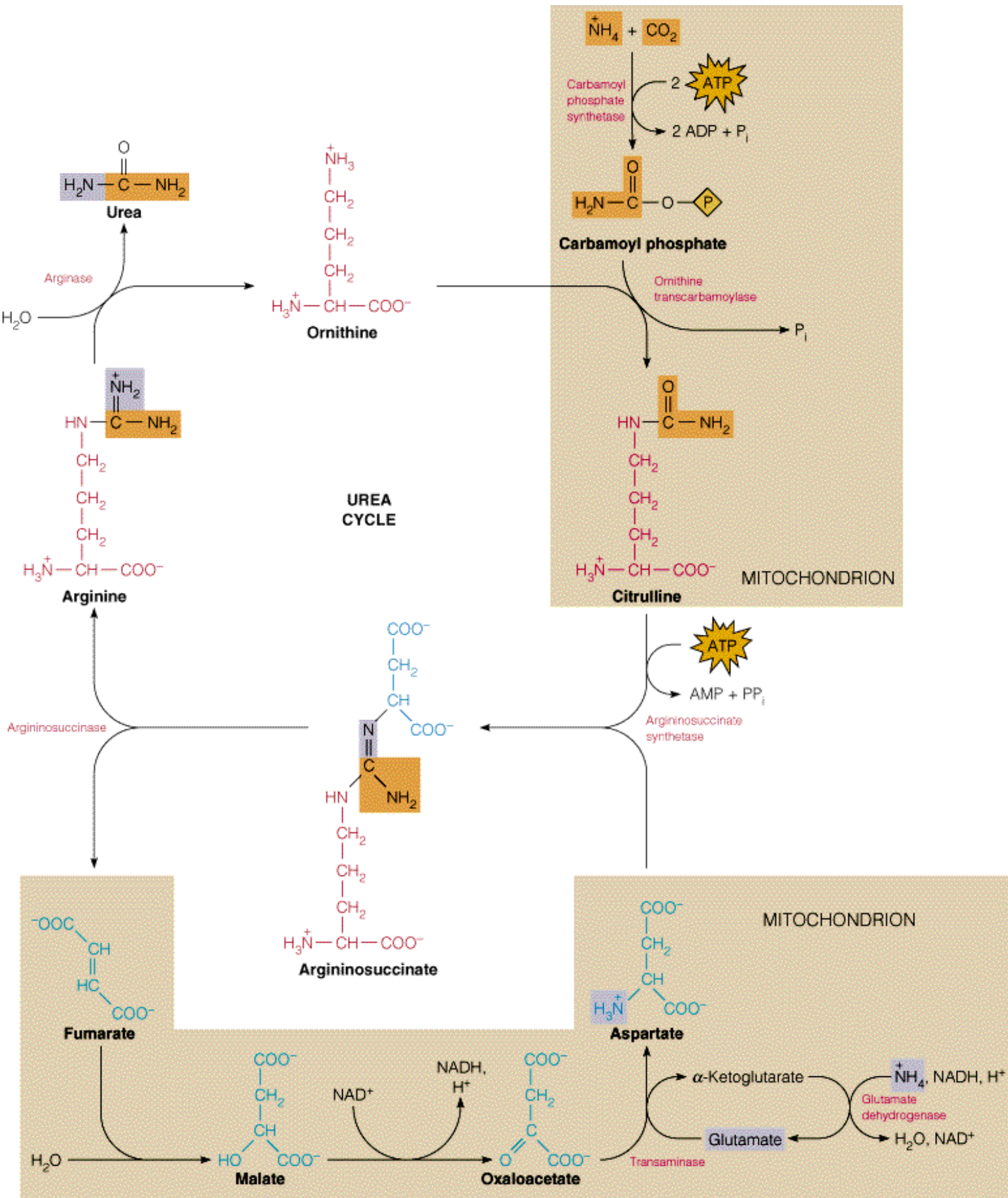

**Malate****Oxaloacetate**

Transaminase



Carbamoyl Phosphate

Carbamoyl phosphate is an intermediate in [arginine](#), [urea](#), and [pyrimidine biosynthesis](#).

Carbamoyl phosphate is created in reactions 1 and 2 below.

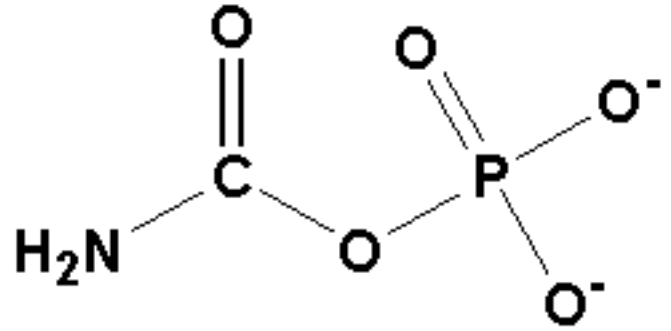

Carbamoyl Phosphate

1. $\text{NH}_4^+ + \text{CO}_2 + 2 \text{ATP} \rightleftharpoons \text{Carbamoyl Phosphate} + 2 \text{ADP} + \text{Pi}$ (catalyzed [Carbamoyl Phosphate Synthetase](#))

2. [Glutamine](#) + [ATP](#) + $\text{HCO}_3^- \rightleftharpoons \text{Glutamate} + \text{Carbamoyl phosphate} + \text{ADP}$ (catalyzed by [Carbamoyl Phosphate Synthetase II](#))

3. Carbamoyl phosphate + [Ornithine](#) \rightleftharpoons [Citrulline](#) + Pi (catalyzed by [Ornithine Transcarbamoylase](#))

4. [Aspartate](#) + Carbamoyl Phosphate \rightleftharpoons [Carbamoyl aspartate](#) (catalyzed by [Aspartate Transcarbamoylase](#))

Carbamoyl phosphate is an allosteric inhibitor of [glutamine synthetase](#), an enzyme with a central role in nitrogen metabolism in the cells.

See also: [Urea Cycle Reactions](#), [Figure 11.35](#), [Figure 22.10](#), [Glutamine Synthetase](#)

INTERNET LINK: [Urea Cycle and Metabolism of Amino Groups](#)

Arginine

Arginine is an **essential amino acid** found in proteins and is one of three **amino acids** categorized as basic amino acids. The basic amino acids are strongly polar, and as a consequence, they are usually found on the exterior surfaces of proteins, where they can be hydrated by the surrounding aqueous environment.

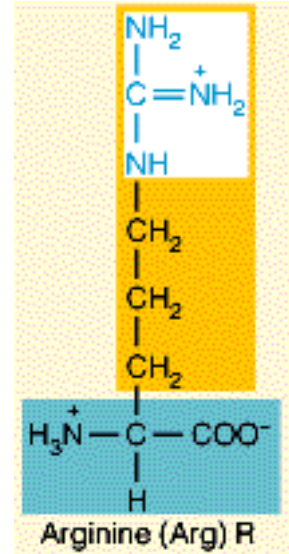

Arginine is an intermediate in the **urea cycle** - **Figure 20.14** (reactions 1-2 shown below).

Arginine is a precursor to nitric oxide. In this unusual reaction, an unprecedented five-electron oxidation of **arginine** occurs (reaction #3 below).

In muscle, **arginine** is also involved as a precursor of creatine and creatine phosphate (Reaction #4 below).

Arginine is classified as an essential amino acid in mammals, meaning it must be present in the diet.

One Letter Code	Three Letter Code	Molecular Wt. (Daltons)	Genetic Code Codons
R	ARG	156.20	CGU, CGC, CGA, CGG, AGA, AGG

Arginine is both metabolically degraded to and synthesized from **glutamate** through ornithine.

- Argininosuccinate** \rightleftharpoons **Arginine** + **Fumarate** (catalyzed by **Argininosuccinase**).
- Arginine** + H₂O \rightleftharpoons **Urea** + **Ornithine** (catalyzed by **Arginase**)
- Arginine** + O₂ \rightarrow **Citrulline** + **Nitric Oxide** (catalyzed by **Nitric Oxide Synthase**).

4. Arginine + Glycine \rightleftharpoons Guanidinoacetate + Ornithine

See also: Table 5.1, Genetic Code, Urea, Ornithine, Citrulline, Glycine, Creatine, Creatine Phosphate, Metabolism of Ornithine and Arginine, Essential Amino Acids

INTERNET LINKS:

1. Arginine Metabolism
 2. Urea Cycle and Metabolism of Amino Groups
-

Essential Amino Acids

Amino acids that must be provided in the diet to meet an animal's metabolic needs are called **essential amino acids** ([Table 20.1](#)). Those that need not be provided because they can be biosynthesized in adequate amounts are called nonessential amino acids.

Mammals require about half of the amino acids in their diet for growth and maintenance of normal nitrogen balance.

Essential Amino Acids in Mammals	Non-Essential Amino Acids in Mammals
Arginine , Histidine , Isoleucine , Leucine , Lysine , Methionine , Phenylalanine , Threonine , Tryptophan , Valine	Alanine , Asparagine , Aspartic Acid , Cysteine , Glutamic Acid , Glutamine , Glycine , Proline , Serine , Tyrosine

See also: [Transamination in Amino Acid Metabolism](#), [Amino Acids](#)

Table 20.1

Essential

Arginine, histidine, isoleucine, leucine, lysine, methionine, phenylalanine, threonine, tryptophan, valine

Nonessential

Alanine, asparagine, aspartate, cysteine, glutamate, glutamine, glycine, proline, serine, tyrosine

Note: In both humans and rats, arginine and histidine are classified as essential amino acids, but nutritional studies show that they are required in the diet only during the growth of juveniles.

Histidine

Histidine is an α **amino acid** found in proteins. In mammals, **histidine** is an essential amino acid, meaning it must be present in the diet. **Histidine's** nonpolar side chain classifies it as a basic amino acid.

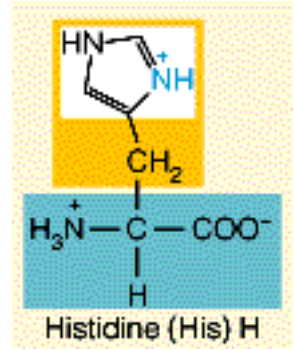

Histidine is the least basic of the three basic amino acids. The imidazole ring in the side chain of the free amino acid loses its proton at about pH 6. When **histidine** is incorporated into proteins, the pKa is raised to about 7 ([Table 5.3](#)). Because the **histidine** side chain can exchange protons near physiological pH, it often plays a role in enzymatic catalysis involving proton transfer.

The basic amino acids are strongly polar, and as a consequence, they are usually found on the exterior surfaces of proteins, where they can be hydrated by the surrounding aqueous environment.

Histidine is an allosteric inhibitor of **glutamine synthetase**, an enzyme with a central role in nitrogen metabolism in the cell.

One Letter Code	Three Letter Code	Molecular Wt. (Daltons)	Genetic Code Codons
H	HIS	137.15	CAU, CAC

See also: [Table 5.1](#), , [Genetic Code](#), [Metabolism of Aromatic Amino Acids and Histidine](#), [Biosynthesis of Histidine / Ames Test](#), [Essential Amino Acids](#)

INTERNET LINK: [Histidine Metabolism](#)

Table 5.3

Group Type	Typical pK_a Range ^a
α -Carboxyl	3.5–4.0
Side chain carboxyls of aspartic and glutamic acids	4.0–4.8
Imidazole (histidine)	6.5–7.4
Cysteine (—SH)	8.5–9.0
Phenolic (tyrosine)	9.5–10.5
α -Amino	8.0–9.0
Side chain amino (lysine)	9.8–10.4
Guanidinyl (arginine)	~12

^aValues outside these ranges are observed. For example, side chain carboxyls have been reported with pK_a values as high as 7.3.

Glutamine

Glutamine is an α amino acid found in proteins. In mammals, **glutamine** is a non-essential amino acid, meaning it does not need to be present in the diet. **Glutamine** is classified as an amide because it is an amide derivative of **glutamic acid** (Reaction 1 below). **Glutamine** is a very important compound in transamination reactions.

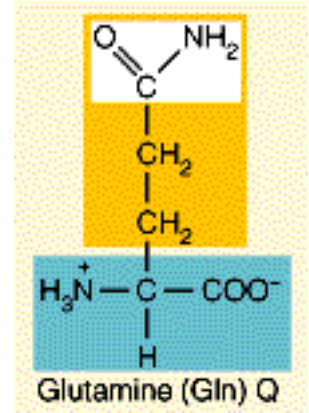

Reactions involving **glutamine**:

1. α -**Ketoglutarate** + **Glutamine** + **NADPH** + H^+ \rightleftharpoons 2 **Glutamate** + **NADP**⁺
(Catalyzed by **Glutamate Synthase**)
2. **Fructose-6-Phosphate** + **Glutamine** \rightleftharpoons **Glucosamine-6-Phosphate** + **Glutamate**
(catalyzed by **Glutamine:Fructose-6-Phosphate Amidotransferase**)
3. **UTP** + **ATP** + **Glutamine** \rightleftharpoons **CTP** + **ADP** + **Glutamate** + Pi (catalyzed by **CTP Synthetase**)
4. **Glutamate** + NH_3 + **ATP** \rightarrow **Glutamine** + **ADP** + Pi (catalyzed by **Glutamine Synthetase**)

One Letter Code	Three Letter Code	Molecular Wt. (Daltons)	Genetic Code Codons
Q	GLN	128.14	CAA, CAG

See also: [Table 5.1, Amino Acids](#), [Genetic Code](#), [Transamination in Amino Acid Metabolism](#) (from Chapter 20), [Utilization of Ammonia](#) (from Chapter 20), [Transamination of Citric Acid Cycle Intermediates](#), [Essential Amino Acids](#)

α -Ketoglutarate (AKG)

α -Ketoglutarate is a [citric acid cycle](#) intermediate and an important compound in amino acid metabolism and transamination reactions. Some relevant metabolic reactions involving **AKG** are shown below.

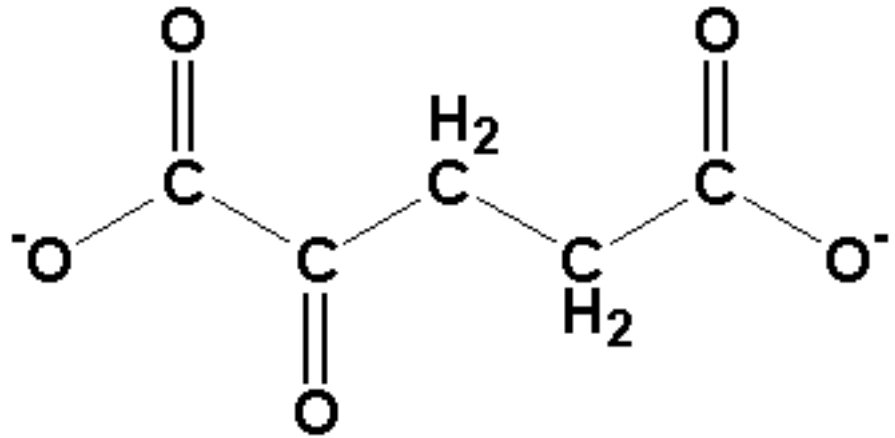

Alpha-keto-glutarate

α -Ketoglutarate is also involved in the malate/aspartate shuttle (see [here](#)) of mitochondria ([Figure 15.11](#)) and enzymatic reactions catalyzed by [procollagen proline hydroxylase](#) that hydroxylate procollagen proline residues in collagen synthesis ([Figure 21.4](#)).

Reactions:

1. [Isocitrate](#) + [NAD⁺](#) \rightleftharpoons α -Ketoglutarate + CO₂ + [NADH](#) (catalyzed by [Isocitrate Dehydrogenase](#))
2. α -Ketoglutarate + [NAD⁺](#) + [CoASH](#) \rightleftharpoons [Succinyl-CoA](#) + CO₂ + [NADH](#) (catalyzed by [\$\alpha\$ -Ketoglutarate Dehydrogenase Complex](#))
3. [Oxaloacetate](#) + [Glutamate](#) \rightleftharpoons [Aspartate](#) + α -Ketoglutarate (transamination catalyzed by [SGOT](#)).
4. α -Ketoglutarate + [Glutamine](#) + [NADPH](#) + H⁺ \rightleftharpoons 2 [Glutamate](#) + [NADP⁺](#) (Catalyzed by [Glutamate Synthase](#))
5. [Alanine](#) + α -Ketoglutarate \rightleftharpoons [Pyruvate](#) + [Glutamate](#) (catalyzed by [Aminotransferase](#)).
6. [Glutamate](#) + [Pyruvate](#) \rightleftharpoons α -Ketoglutarate + [Alanine](#) (catalyzed by [SGPT](#))

See also: [Enzymes](#) of the citric acid cycle, [Figure 14.3](#), [Table 14.1](#), [Citric Acid Cycle Intermediates in Amino Acid Metabolism](#), [Glutamate as a Precursor of Other Amino Acids](#), [Transamination in Amino Acid Metabolism](#)

INTERNET LINKS:

1. [Citric Acid Cycle](#)
 2. [Urea Cycle and Metabolism of Amino Groups](#)
-

Shuttling Electron Carriers into the Mitochondrion

The inner mitochondrial membrane is impermeable to **NADH**. Electrons carried by NADH that are created in the cytoplasm (such as in **glycolysis**) must be shuttled into the mitochondrial matrix before they can enter the **electron transport** system (ETS).

This shuttle involves the reduction of a substrate by NADH molecules in the cytoplasm, passage of the reduced substrate into the mitochondrial matrix via a specific transport system, reoxidation of that compound inside the matrix, and passage of the oxidized substrate back to the cytoplasm, where it can undergo the same cycle again.

Figure 15.11a illustrates the dihydroxyacetone phosphate (**DHAP**)/glycerol-3-phosphate (**Gly-3-P**) shuttle system that is active in brain and in the flight muscle of insects. In the shuttle, NADH reduces DHAP to Gly-3-P. Gly-3-P donates electrons to **Glycerol-3-phosphate dehydrogenase** in the inner mitochondrial membrane, regenerating DHAP and converting FAD to **FADH₂** in the process. Note that the shuttle transfers electrons from NADH ultimately to make FADH₂, which transfers electrons to **CoQ**, bypassing complex I. This process is inefficient, however, because electrons that are passed from NADH to complex I generate enough energy to make 3 ATPs per pair of electrons, but electrons entering after complex I only generate enough energy to make 2 ATPs.

Figure 15.11b shows the **malate/aspartate** shuttle system, which is particularly active in liver and heart. It uses malate, aspartate, and **oxaloacetate** to shuttle cytoplasmic electrons from NADH into the mitochondrial matrix. In this shuttle, NADH reduces oxaloacetate to malate, which travels through an inner membrane transport system that ultimately exchanges the malate for an **α-ketoglutarate**. To do so, malate first donates electrons to NAD⁺, forming NADH and oxaloacetate in the process. Then, in order to regenerate the original substrates in their original locations, oxaloacetate is transaminated to aspartate by glutamate, which is simultaneously converted to α-ketoglutarate. Aspartate is transported out of the mitochondrion in exchange for glutamate. Outside the mitochondrion, aspartate is converted to oxaloacetate by transaminating α-ketoglutarate to glutamate. Unlike the DAHP/Gly-3-P shuttle, none of the energy of the electrons is wasted in the malate/aspartate shuttle, because the NADH generated inside the mitochondrial matrix passes electrons to complex I, enabling production of 3 ATPs per pair of electrons from NADH.

See also: **Electron Transport**, **Mitochondrial Structure and Function**

Electron Transport

The **electron transport system** is the place in the cell where electrons generated by oxidation are transferred. Passage of the electrons through the **system** generates potential energy that is used to make **ATP** in oxidative phosphorylation.

The E0' values for the electron carriers in the mitochondrial membrane increase in the same order as the sequence in which they are used in **electron transport**. The order is consistent with being exergonic for the redox reactions. **Figure 15.10** lists the contents of the various multiprotein complexes described below:

NADH and NADH Dehydrogenase (Complex I) - NADH is generated by numerous dehydrogenases in the cell. NADH is reoxidized to NAD⁺ by complex I of the mitochondria (also called NADH dehydrogenase). NADH dehydrogenase contains flavin mononucleotide (FMN) as a tightly bound prosthetic group and catalyzes the following reaction

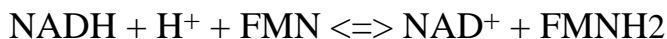

Complex I contains about 25 separate polypeptide chains. It also contains iron-sulfur centers, which transfer electrons from FMNH₂ to the next carrier, coenzyme Q. **Figure 15.4** shows four known structures of the non-heme iron sulfur complexes in Complex I. Iron centers undergo cyclic oxidoreduction between ferrous and ferric states, as shown **here**. Complex I is also called NADH-coenzyme Q reductase because the electrons are used to reduce coenzyme Q. The passage through Complex I can be blocked by the compounds rotenone and amytal and the artificial electron acceptor methylene blue can accept electrons from FMNH₂ **Figure 15.9**.

Complex II (succinate dehydrogenase) - Complex II is not in the path traveled by electrons from Complex I (**Figure 15.3**). Instead, it is a point of entry of electrons from FADH₂ produced by the enzyme succinate dehydrogenase in the citric acid cycle. Both complexes I and II donate their electrons to the same acceptor, coenzyme Q. Complex II, like complex I, contains iron-sulfur proteins, which participate in electron transfer. It is also called succinate-coenzyme Q reductase because its electrons reduce coenzyme Q.

Coenzyme Q (CoQ) - CoQ is a benzoquinone linked to a number of isoprene units (usually 10 in mammalian cells and 6 in bacteria). The isoprenoid tail gives the molecule its apolar character, which allows CoQ to diffuse rapidly through the inner mitochondrial membrane. CoQ has the ability to accept electrons in pairs and pass them one at a time through a semiquinone intermediate to Complex III (see **here**). This cycle is referred to as

the Q cycle.

Complex III - Complex III contains a diversity of electron carrying proteins. They include cytochrome b, iron sulfur centers, and cytochrome c1. Cytochrome b is the first of the [heme](#)-carrying proteins ([Figure 15.6](#)) involved in electron transport. Passage of electrons from cytochrome b to the iron sulfur centers can be blocked by antimycin A. Also, the artificial electron acceptor phenazine methosulfate can accept electrons from cytochrome b and 2,6-dichlorophenol-indophenol can accept electrons from the iron sulfur proteins ([Figure 15.9](#)). The crystal structure of the redox components of complex III from bovine heart mitochondria is shown in [Figure 15.16](#)

Cytochrome c - This small protein is the only one from the electron transport system not in a complex. It accepts electrons from complex III and shuttles them to complex IV. The artificial electron carrier, tetramethyl-p-phenylene diamine can accept electrons from cytochrome c ([Figure 15.9](#)).

Complex IV - Complex IV is also known as cytochrome oxidase, because it takes electrons from cytochrome c. Complex IV contains cytochromes a and a₃. Cytochromes a and a₃ evidently represent two identical heme A moieties, attached to the same polypeptide chain. They are within different environments in the inner membrane, however, so they have different reduction potentials. Each of the hemes is associated with a copper ion, located close to the heme iron. Electrons that pass through complex IV can be blocked by cyanide, azide, and carbon monoxide and the artificial electron carrier, ferricyanide, can accept electrons from cytochrome a in the complex ([Figure 15.9](#)). A model for the final stages in proton pumping by cytochrome oxidase is shown in [Figure 15.18](#).

See also: [Difference Spectra](#), [Inhibitors and Artificial Electron Acceptors](#), [FMN](#), [FMNH₂](#), [NAD⁺](#), [NADH](#), [Rotenone](#), [Amytal](#), [Coenzyme Q](#), [Cytochromes](#), [Antimycin A](#), [Cyanide](#), [Azide](#), [Carbon Monoxide](#).

Figure 15.10: Multiprotein complexes in the respiratory assembly.

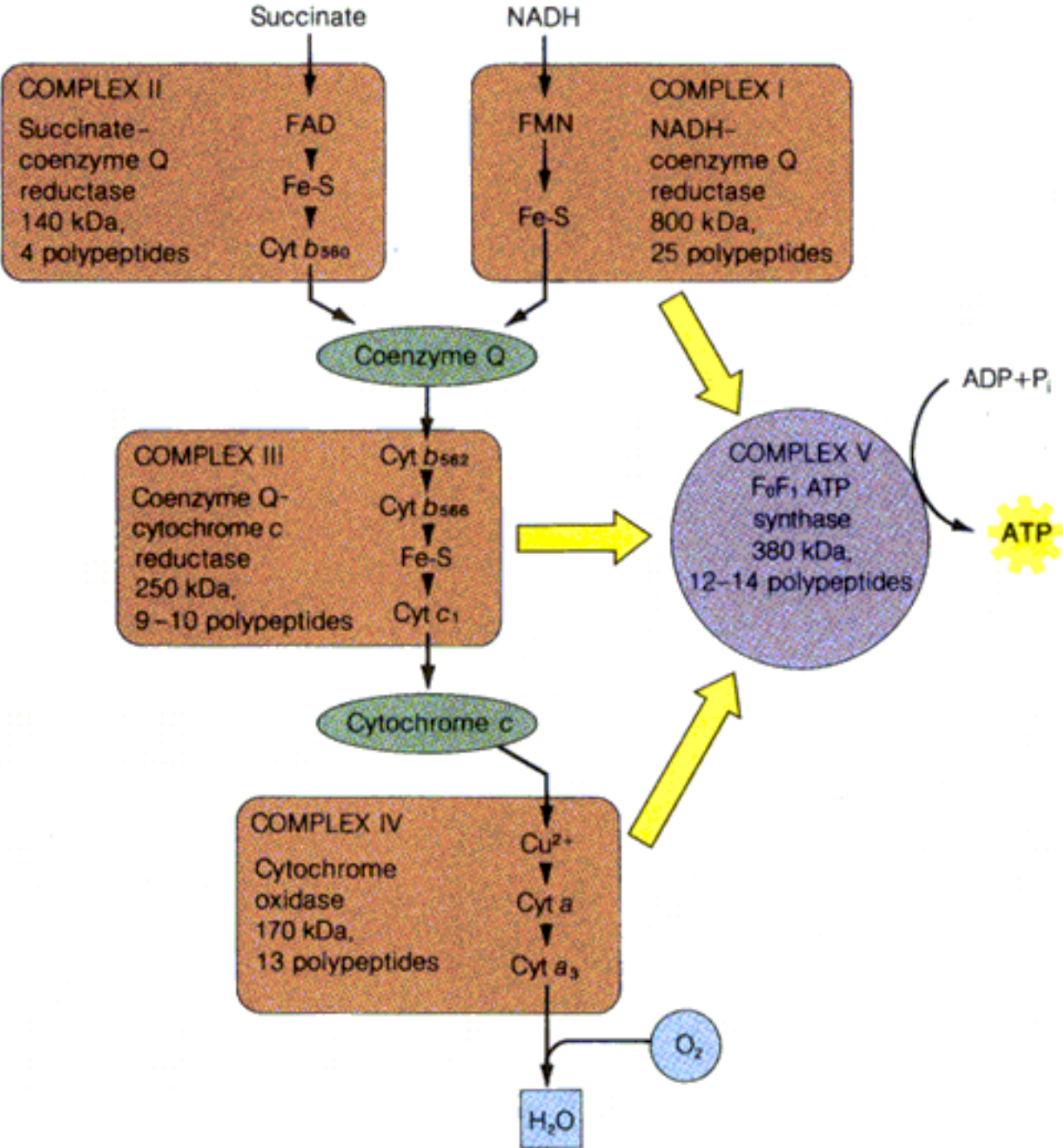
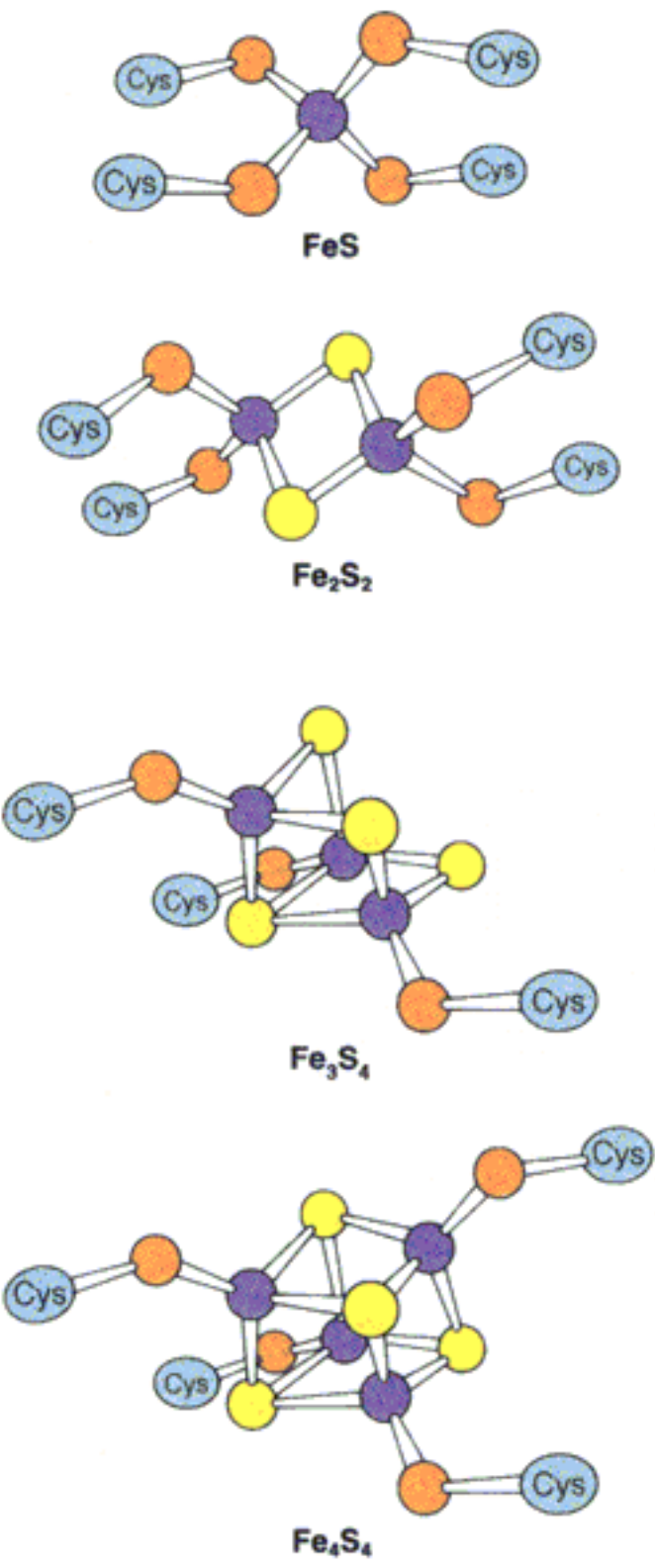





Figure 15.4: Structures of iron-sulfur centers.



Key:

 Iron	 Inorganic sulfur
 Cysteine sulfur	

● iron

● inorganic sulfur

● Cysteine sulfur

Unnumbered Item

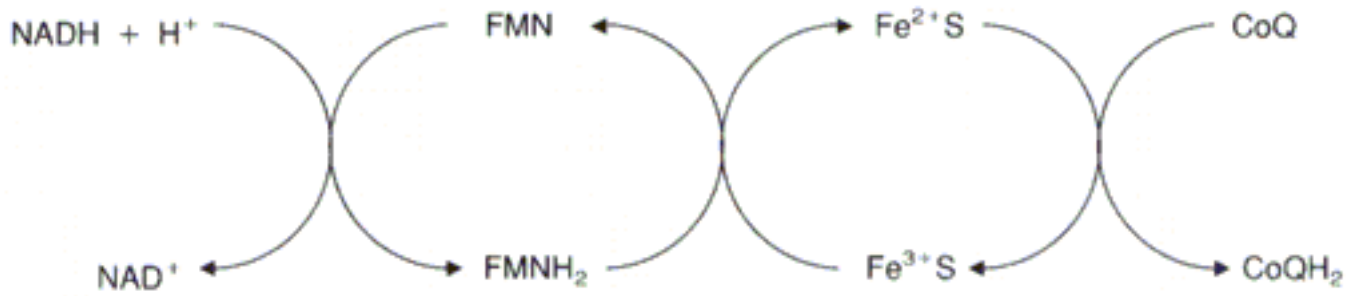
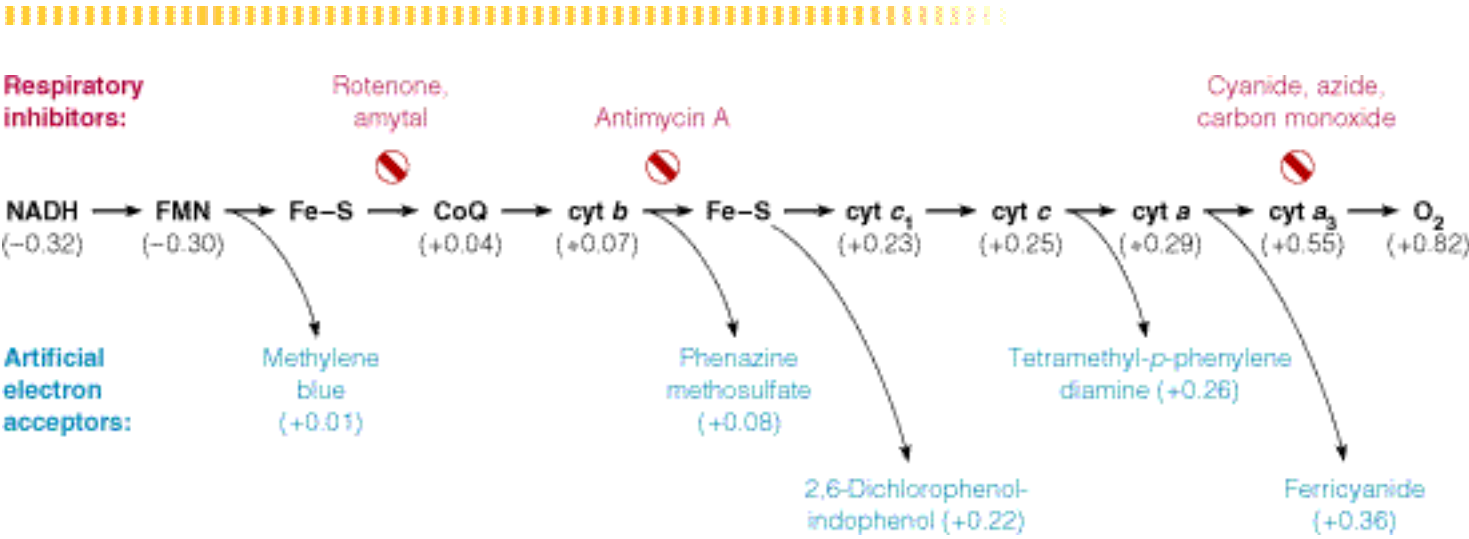

Figure 15.9: Sites of action of some respiratory inhibitors and artificial electron acceptors.



Succinate Dehydrogenase

Succinate dehydrogenase (also called **succinate-coenzyme Q reductase** or **Complex II**) is an enzyme of the [citric acid cycle](#) and [glyoxylate cycle](#), that catalyzes the reaction below:



In the reaction, a *trans* double bond is formed, with transfer of the two hydrogens to FAD, forming FADH₂.

FAD is bound covalently to the enzyme protein through a specific histidine residue. **Succinate dehydrogenase** is tightly bound to the mitochondrial inner membrane. The importance of this binding is that the reduced flavin, which must be reoxidized for the enzyme to act again, becomes reoxidized through interaction with the mitochondrial [electron transport](#) system, also bound to the membrane.

Succinate dehydrogenase is inhibited by [malonate](#).

[Next](#) enzyme of citric acid cycle / [Previous](#) enzyme of citric acid cycle

See also: [Citric Acid Cycle Enzymes](#), [Table 14.1](#)

INTERNET LINKS:

1. [Glyoxylate Cycle Metabolism](#)
 2. [Citric Acid Cycle](#)
-

Succinate

Succinate is an intermediate of the [citric acid cycle](#) (and the glyoxylate cycle) produced by action of the enzyme [succinyl-CoA synthetase](#) on succinyl-CoA. **Succinate** is converted to fumarate by action of the enzyme [succinate dehydrogenase](#) (with formation of FADH₂)

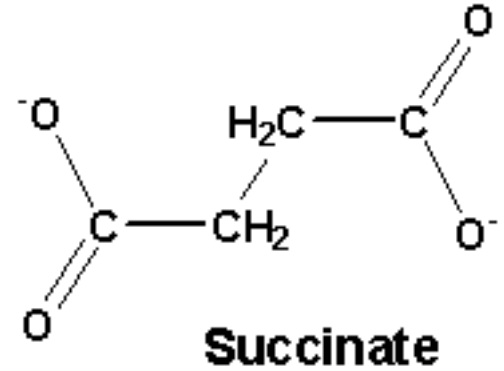

See also: [Citric Acid Cycle Intermediates](#), [Figure 14.3](#), [Table 14.1](#), [Glyoxylate Cycle](#)

INTERNET LINKS:

1. [Glyoxylate Cycle Metabolism](#)
 2. [Citric Acid Cycle](#)
-

Succinyl-CoA

Succinyl-CoA is an intermediate of the [citric acid cycle](#) produced by decarboxylation of α -ketoglutarate. The reaction is catalyzed by the α -[ketoglutarate dehydrogenase](#) enzyme complex. **Succinyl-CoA** is converted to succinate (with formation of [GTP](#)) in a reaction catalyzed by the enzyme [succinyl-CoA synthetase](#).

Succinyl-CoA is also a product of a reaction catalyzed by [L-methylmalonyl-CoA mutase](#), an enzyme in metabolism of propionyl-CoA.

Succinyl-CoA is an allosteric inhibitor of α -[ketoglutarate dehydrogenase](#).

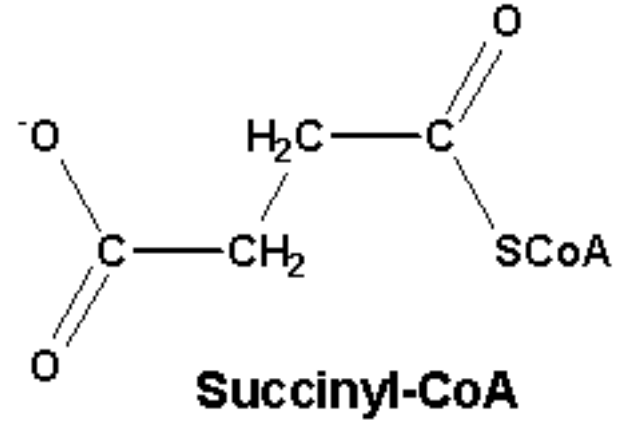

See also: [Citric Acid Cycle Intermediates](#), [Figure 14.3](#), [Table 14.1](#), [Propionyl-CoA](#)

INTERNET LINK: [Citric Acid Cycle](#)

α -Ketoglutarate Dehydrogenase

α -Ketoglutarate dehydrogenase (**AKGDH**) is an enzyme of the citric acid cycle that catalyzes the decarboxylation of α -ketoglutarate.



The enzyme uses [thiamine pyrophosphate](#) as a coenzyme ([Figure 14.14](#)) and is very similar in mechanism of action to the [pyruvate dehydrogenase complex](#) ([Figure 14.10](#))

AKGDH exists as a complex, similar to the pyruvate dehydrogenase complex, with three analogous enzyme activities and the same five coenzymes - thiamine pyrophosphate, [NAD⁺](#), [FAD](#), [lipoic acid](#), and [CoASH](#).

Notably, the **AKGDH** complex differs from the pyruvate dehydrogenase complex in that the regulatory activities associated with the pyruvate dehydrogenase complex are not present in the α -ketoglutarate dehydrogenase complex.

[Next](#) enzyme of citric acid cycle / [Previous](#) enzyme of citric acid cycle

See also: [Citric Acid Cycle](#), [Enzymes of the Citric Acid Cycle](#), [Reaction Picture](#), [Table 14.1](#),

INTERNET LINKS:

1. [\$\alpha\$ -Keto Acid Complexes - A Review](#)
 2. [Citric Acid Cycle](#)
-

Intermediates of the Citric Acid Cycle

Acetyl-CoA

Oxaloacetate

Citrate

cis-Aconitate

D-Isocitrate

α -ketoglutarate

Succinyl-CoA

Succinate

Fumarate

L-Malate

See also: [Citric Acid Cycle](#), [Citric Acid Cycle Enzymes](#), [Figure 14.3](#), [Table 14.1](#)

INTERNET LINK: [Citric Acid Cycle](#)

Citrate Synthase

Citrate synthase is an enzyme of the [citric acid cycle](#) (and glyoxylate cycle) that catalyzes the condensation of acetyl-CoA and oxaloacetate to form citrate. The reaction is as follows:



[Citroyl-CoA](#) is an intermediate in the reaction.

Note that the large negative $\Delta G^{\circ\prime}$ value of this reaction helps to "pull" the highly positive $\Delta G^{\circ\prime}$ of the reaction preceding it.

Citrate synthase is regulated by availability of substrates - acetyl-CoA and oxaloacetate.

[Next](#) enzyme of citric acid cycle / [Previous](#) enzyme of cycle

See also: [Glyoxylate Cycle Reactions](#), [Enzymes of the Citric Acid Cycle](#), [Reaction Picture](#), [Table 14.1](#), [Thioester Bond Energy](#)

INTERNET LINKS:

1. [Glyoxylate Cycle Metabolism](#)
 2. [Citric Acid Cycle](#)
-

Citroyl-CoA

Citroyl-CoA is an intermediate in synthesis of citrate from acetyl-CoA and oxaloacetate. In this reaction, catalyzed by citrate synthase, **citroyl-CoA** spontaneously hydrolyzes in the second part of the reaction ([Figure 14.11](#)).

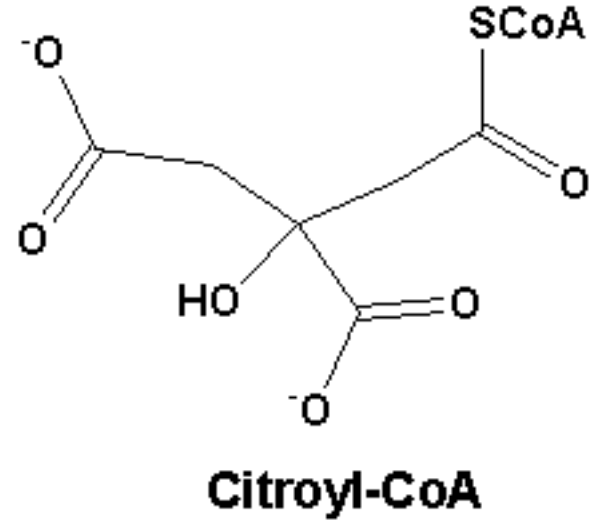

See also: [Citrate Synthase](#), [Citrate](#), [Citric Acid Cycle](#), [Acetyl-CoA](#), [Oxaloacetate](#)

Figure 14.11: Mechanism of the citrate synthase reaction.

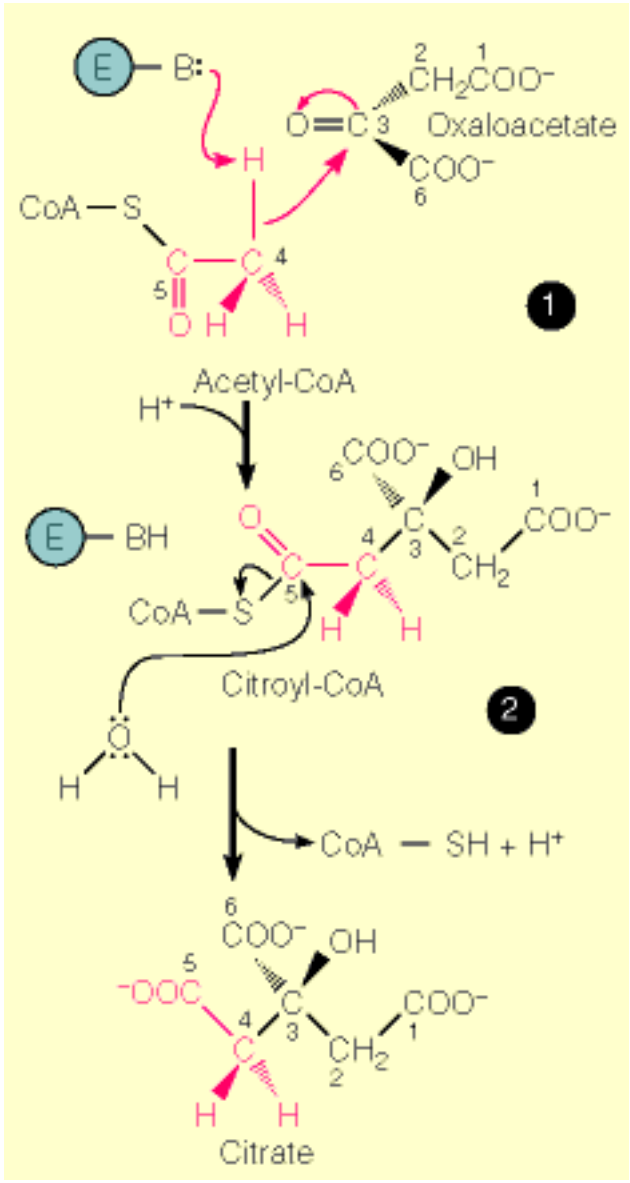

Fluorocitrate

Fluorocitrate is an inhibitor of the citric acid cycle enzyme, aconitase.

Fluorocitrate is produced by catalytic combination of fluoroacetyl-CoA (see fluoroacetate) with oxaloacetate by the enzyme citrate synthase.

See also: [Aconitase](#), [Fluoroacetate](#), [Citrate Synthase](#), [Reaction Diagram](#), [Acetate Thiokinase](#)

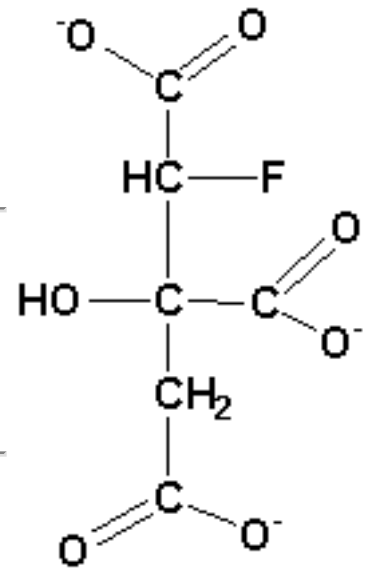

Fluorocitrate

Fluoroacetate

Metabolism of **fluoroacetate** produces an inhibitor of the citric acid cycle enzyme, aconitase. **Fluoroacetate** is known as a suicide substrate because by itself it is not toxic to cells, but it kills cells by being made into a toxic substance. For **fluoroacetate**, this occurs as follows:

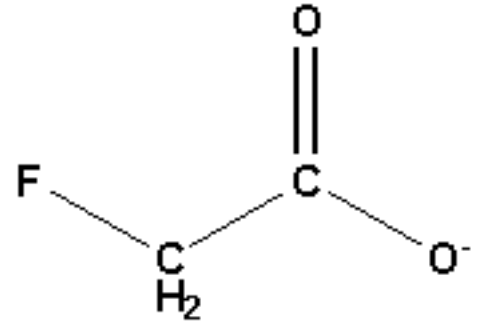

Fluoroacetate

Cells readily convert fluoroacetate to fluoroacetyl-CoA in a reaction catalyzed by the enzyme acetate thiokinase ([reaction diagram](#)). Fluoroacetyl-CoA can combine with oxaloacetate to form fluorocitrate in a reaction catalyzed by the citric acid cycle enzyme, citrate synthase. Fluorocitrate is toxic to cells because it inhibits aconitase.

Fluoroacetate is a plant product that has been used as a pesticide. Its use by ranchers in the West to control coyote populations has led also to the death of eagles.

See also: [Fluorocitrate](#), [Acetate Thiokinase](#), [Aconitase](#), [Citrate Synthase](#)

Unnumbered Item

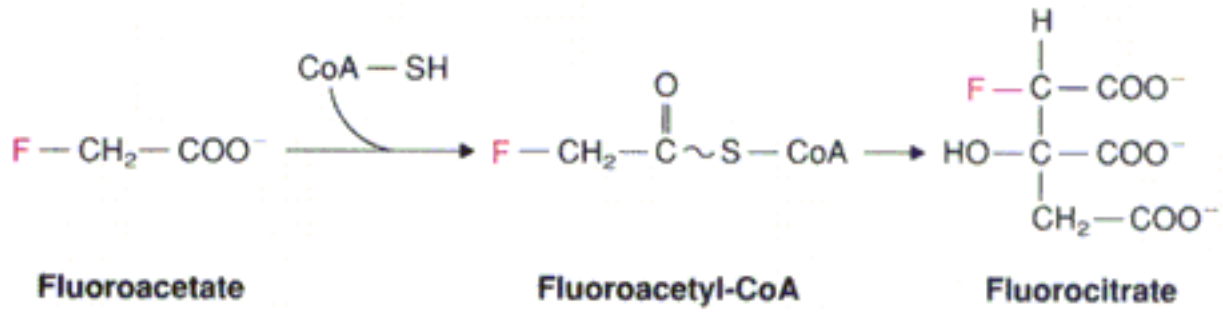

Acetate Thiokinase

Acetate thiokinase catalyzes the following reaction:

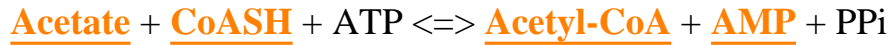

The enzyme will also act on fluoroacetate in the same manner, converting it to fluoroacetyl-CoA, which, after combination with oxaloacetate to form fluorocitrate, inhibits the citric acid cycle enzyme aconitase. Thus, fluoroacetate can be very deadly to cells.

See also: Citric Acid Cycle

Acetic Acid (Acetate)

Acetate in cells can be converted to a more activated form (acetyl-CoA) by the following reaction:

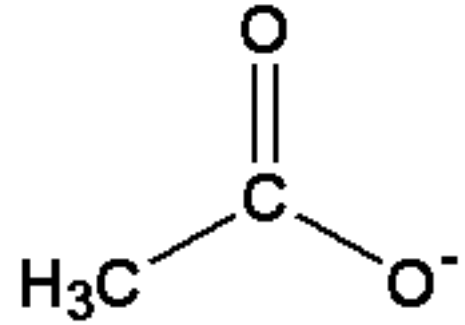

Acetic acid (acetate)

Acetate + **CoASH** + **ATP** \rightleftharpoons **Acetyl-CoA** + **AMP** + PPi (catalyzed by **Acetate Thiokinase**)

Acetate is also produced in the reaction catalyzed by **acetylcholinesterase** in nerve tissue:

Acetylcholine + H₂O \rightleftharpoons **Choline** + **Acetate**

See also: **Acetyl-CoA**, **Figure 2.17**, **Biochemistry of Neurotransmission**, **Neurotransmitters and Biological Regulators**

Maltose

Maltose is a **disaccharide** of **glucose** units joined α -1,4. It differs from cellobiose, which is also a glucose disaccharide with units joined β -1,4. The enzyme, **maltase**, catalyzes hydrolysis of **maltose** to two molecules of D-glucose.

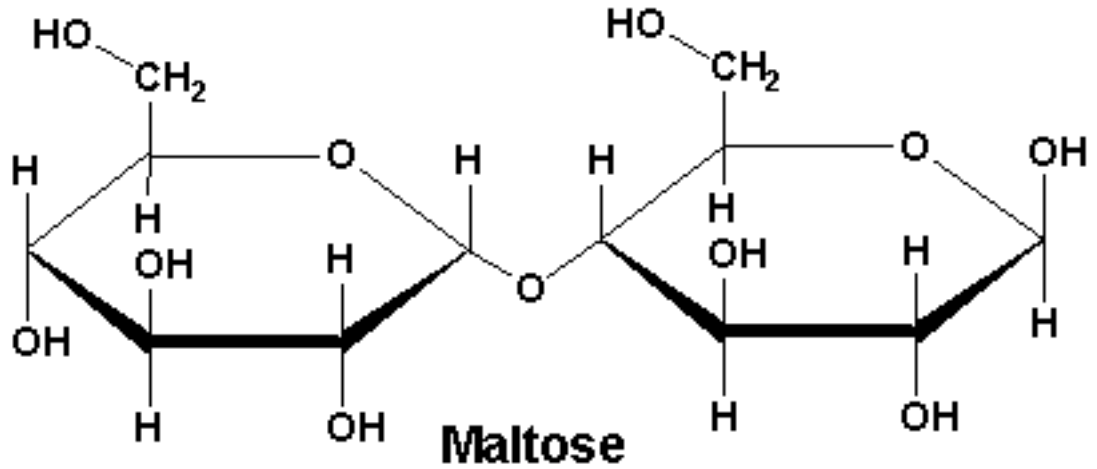

See also: [Figure 9.1](#), [Table 9.5](#), [Figure 9.16a](#), [cAMP Receptor Protein](#)

Disaccharides



A **disaccharide** is a saccharide containing two monosaccharide residues. Common examples include sucrose, maltose, lactose, trehalose, cellobiose, and gentiobiose.

See also: Oligosaccharides, Monosaccharides

Saccharides

Saccharide is another name for a carbohydrate. Simple **saccharides** are the monosaccharides, commonly called sugars. **Glucose** is an example of a monosaccharide. Others are shown in [Figure 9.9a](#) and [Figure 9.9b](#). We use the terms monosaccharide, oligosaccharide, or polysaccharide to refer to compounds composed of a single sugar, several sugars linked together, or many sugars linked together, respectively.

The term carbohydrate derives from the fact that many of them have a formula that can be simplified to $(\text{CH}_2\text{O})_n$. Some of these compounds are chemically modified, however, and do not fit the formula due to the modification.

Saccharides play a variety of roles in living organisms, including energy storage ([monosaccharides](#) and [oligosaccharides](#)), structural roles ([polysaccharides](#)), and cell identity (oligosaccharides).

See also: [Monosaccharide Nomenclature](#), [Derivatives of Monosaccharides](#)

Figure 9.9a: Stereochemical relationships of the D-aldoses.

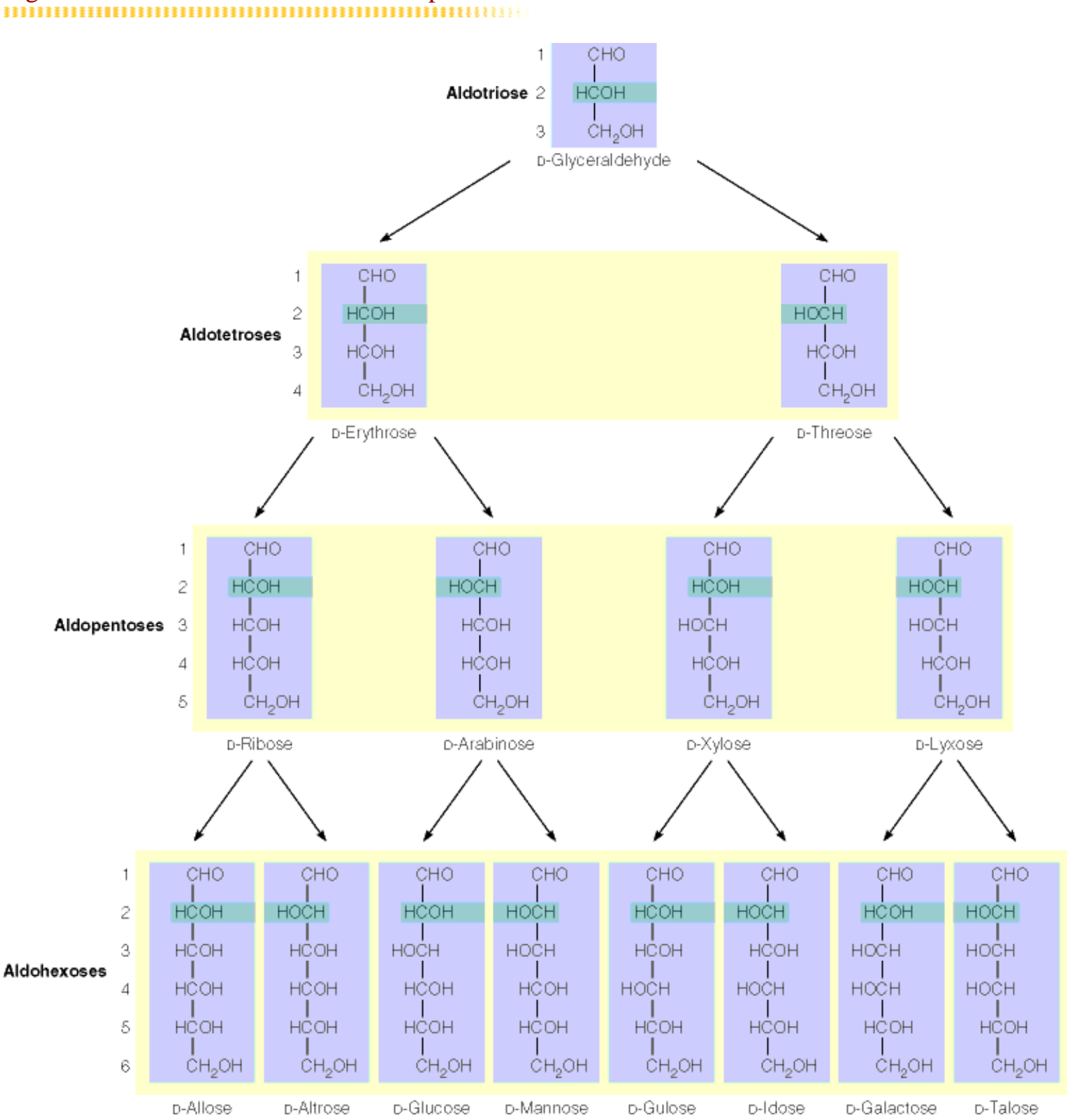

(a) D-Aldoses

Figure 9.9b: Stereochemical relationships of the D-ketoses.

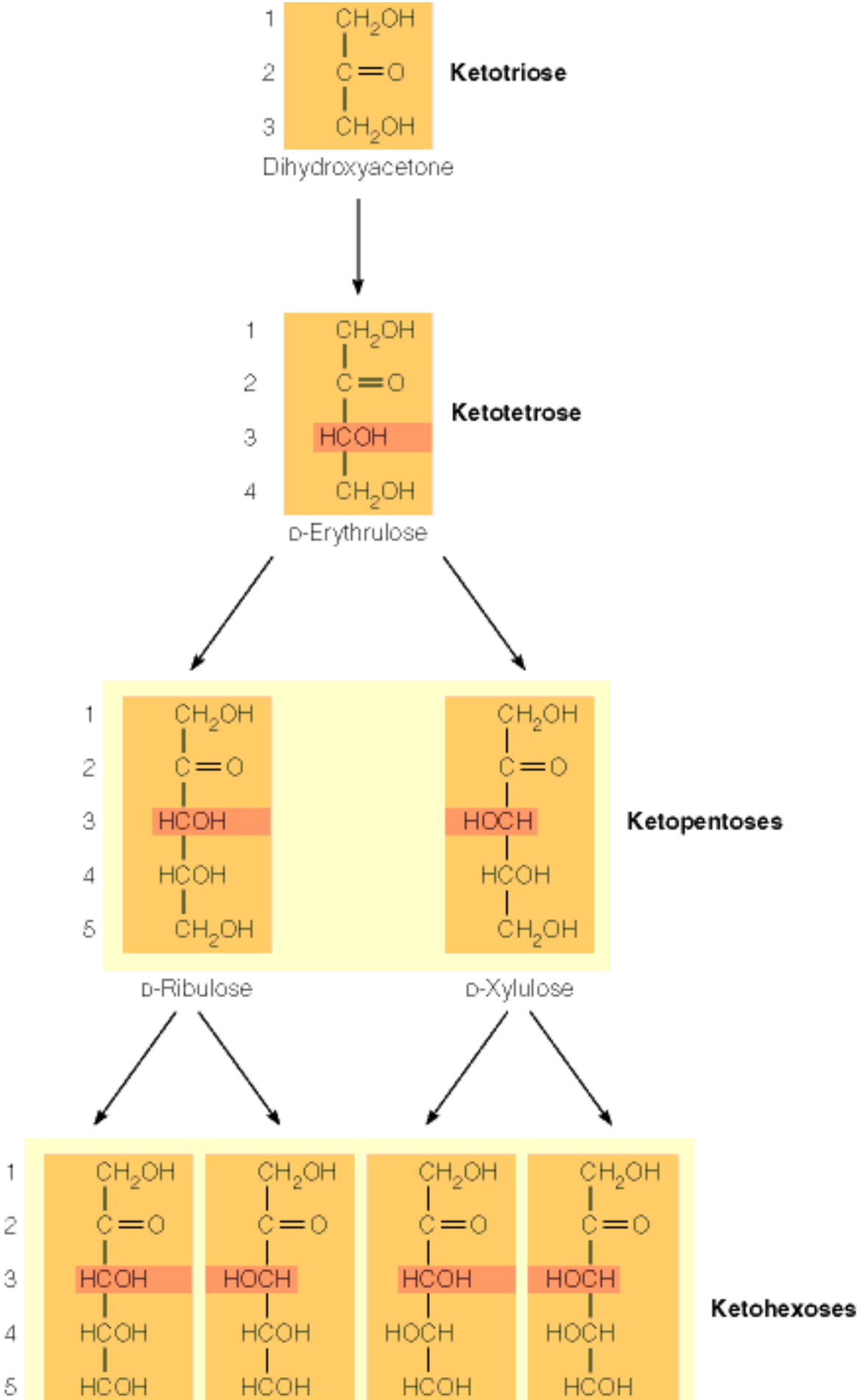

Ketohexoses

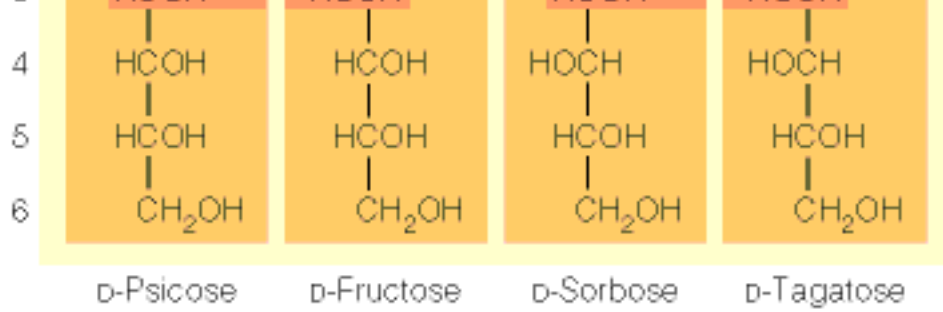

(b) D-Ketoses

Monosaccharides

Monosaccharide is another term for a simple sugar, such as glucose, which is not linked to any other sugars.

Common **monosaccharides** include:

[Glucose](#)

[Mannose](#)

[Fructose](#)

[Ribose](#)

[Galactose](#)

[Erythrose](#)

Monosaccharides may be called trioses, tetroses, pentoses, hexoses, heptoses, or octoses, depending on whether they have 3, 4, 5, 6, 7, or 8 carbons, respectively, in them.

Monosaccharides containing an aldehyde group are called aldoses.

Monosaccharides containing a ketone group are called ketoses.

Monosaccharides that form five member rings are called furanoses.

Monosaccharides that form six member rings are called pyranoses.

See also: [Monosaccharide Nomenclature](#), [Oligosaccharides](#), [Polysaccharides](#)

Mannose

Mannose is a monosaccharides. Containing six carbons and an aldehyde group, it is classified as an aldose and a hexose. **Mannose** is a constituent of glycoproteins and a few polysaccharides.

Mannose is phosphorylated by hexokinase to mannose-6-phosphate, which is readily isomerized to fructose-6-phosphate for entry into glycolysis or gluconeogenesis (Figure 13.12).

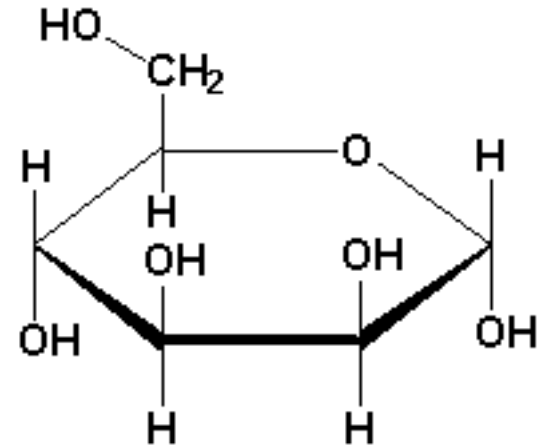

Mannose

See also: Monosaccharide Nomenclature, Diastereomers, Saccharides, Mannitol

INTERNET LINK: Fructose and Mannose Metabolism

Glycoproteins



More than half of all eukaryotic proteins carry covalently attached oligosaccharide or polysaccharide chains. **Glycoproteins** differ from proteoglycans in that proteoglycans are predominantly composed of glycosamino-glycan polysaccharides connected to extended core polypeptides, forming huge feathery molecules.

Glycoproteins are classified as N-linked or O-linked in two groups ([Figure 9.28](#)). In N-linked **glycoproteins**, the glycans are usually attached through [N-acetylglucosamine](#) or [N-acetylgalactosamine](#) to the side chain amino group in an [asparagine](#) residue. In O-linked glycoproteins, glycans are usually attached through an O-glycosidic bond between N-acetylgalactosamine and the hydroxyl group of a [threonine](#) or [serine](#) residue. See also [Table 9.6](#).

N-linked Glycans

A common foundation for N-linked glycans is shown in [here](#). Important N-linked glycans are found in ovalbumin and the [immunoglobulins](#). Every immunoglobulin has carbohydrate attached to the constant domain of each heavy chain. Part of the recognition of immunoglobulins is due to the sequence of the oligosaccharide chains of the glycans.

A very important further use of N-linked oligosaccharides is in intracellular targeting in eukaryotic organisms. Proteins destined for certain organelles or for excretion from the cell are marked specifically by oligosaccharides during posttranslational processing to ensure they arrive at their proper destinations.

O-Linked Glycans

Mucins, which are found extensively in salivary secretions, contain many short O-linked glycans. These glycoproteins increase the viscosity of the fluids in which they are dissolved.

Some O-linked glycans appear to function in intracellular targeting and molecular and cellular identification. An example is found in the blood group antigens ([Figure 9.29](#)).

Antarctic fish contain a glycoprotein that serves as an "antifreeze", preventing the freezing of body fluids, even in extremely cold water.

See also: [Structural polysaccharides](#), [Oligosaccharides and Polysaccharides as Cell Markers](#), [Biosynthesis of Glycoconjugates](#) (from Chapter 16)

Figure 9.28: Glycoprotein bonds.

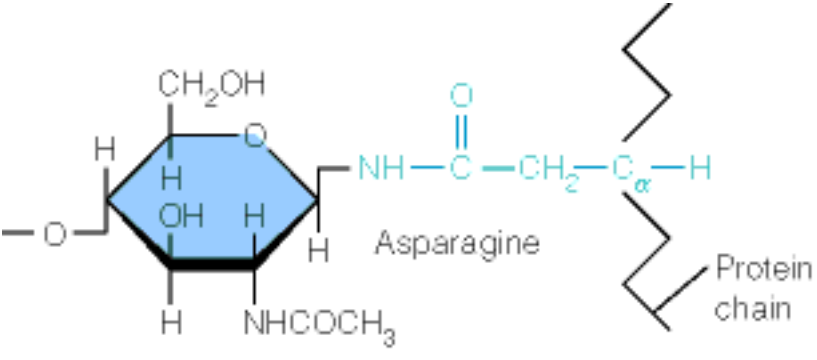

(a) N-Acetylglucosamine

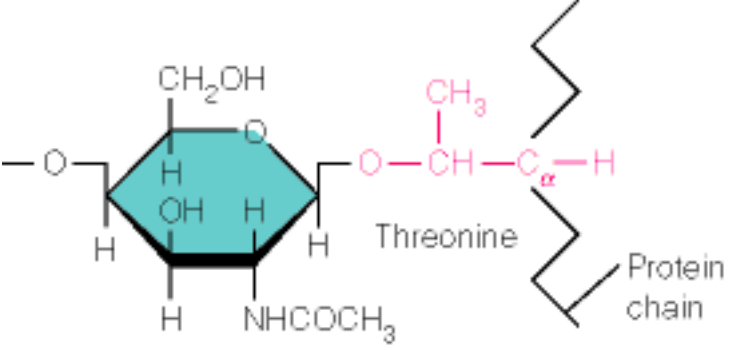

(b) N-Acetylgalactosamine

N-Acetyl- β

N-Acetyl- β -D-glucosamine is the monomeric unit of [chitin](#). It is also part of the peptidoglycan polymer of Gram-positive bacterial cell walls. It is also a component of [hyaluronic acid](#) in conjunction with [glucuronic acid](#).

N-Acetyl- β -D-glucosamine is also a component of the ABO blood group antigens ([Figure 9.29](#)).

See also: [Biosynthesis of Glycoconjugates](#), [Glycoproteins](#), [Figure 9.28](#), [Bacterial Cell Walls](#), [Biosynthesis of Other Polysaccharides](#), [UDP-N-Acetylglucosamine](#)

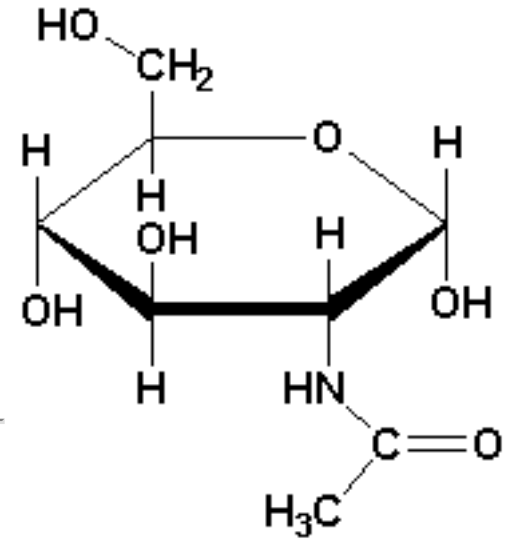

N-acetylglucosamine

Chitin

Chitin is a polymer of of [N-acetyl- \$\beta\$ -D-glucosamine](#). The linkage between individual N-acetyl- β -D-glucosamine units is β -1,4, giving it a structure similar to that of [cellulose](#), except that the hydroxyl on carbon 2 of each residue is replaced by an acetylated amino group.

Chitin is widely distributed among the kingdoms of organisms. It is a minor constituent in most fungi and some algae, where it often substitutes for cellulose or other glucans. In dividing yeast cells, **chitin** is found in the septum that forms between the separating cells. The best known role of **chitin**, however, is in invertebrate animals; it constitutes a major structural material in the exoskeletons of many **arthropods and mollusks**. In many of these exoskeletons, **chitin** forms a matrix on which mineralization takes place, much as [collagen](#) acts as a matrix for mineral deposition in vertebrate bones. The evolutionary implications are interesting. As animals evolved to the size that made rigid body parts essential, quite different paths were taken. The vertebrates developed a mineral skeleton on a collagen matrix. Annelids such as earthworms also use collagen, but in a segmented exoskeleton. The arthropods and mollusks also developed exoskeletons, but theirs were built on **chitin**-a carbohydrate rather than a protein matrix.

See also: [Polysaccharides](#)

Cellulose

Cellulose is the major structural polysaccharide in woody and fibrous plants and is the most abundant single polymer in the biosphere. Like amylose, **cellulose** is a linear polymer of **D-Glucose** (and hence is also a glucan), but in **cellulose** the sugar residues are connected by $\beta(1\rightarrow4)$ linkages. This seemingly small difference from starch has remarkable structural consequences. **Cellulose** can exist as fully extended chains, with each glucose residue flipped by 180° with respect to its neighbor. In this extended form, the chains can form ribbons that pack side by side with a network of hydrogen bonds within and between them. This arrangement is reminiscent of the β -sheet structure in silk **fibroin**, and as in fibroin, the fibrils of **cellulose** have great mechanical strength but limited extensibility.

The same small difference between **cellulose** and starch has another important consequence: Animal enzymes that are able to catalyze the cleavage of the $\alpha(1\rightarrow4)$ link in starch cannot cleave cellulose. For this reason, humans, even if starving, are unable to utilize the enormous quantities of glucose all around them in the form of **cellulose**. Ruminants such as cows can digest **cellulose** only because their digestive tracts contain symbiotic bacteria that produce the necessary cellulases. Termites manage to eat woody substances in a similar fashion-their guts harbor protozoans capable of **cellulose** digestion. Many fungi also produce such enzymes, which is why some mushrooms can live on wood as a carbon source. **Cellulose** is not made strictly in the plant kingdom. Marine invertebrates called tunicates produce **cellulose** in the hard outer mantle. There may be even small amounts of **cellulose** in human connective tissue.

See also: [Structural Polysaccharides](#), [Amylose](#), [Starch](#), [Glycogen](#), [Hydrogen Bonds](#), [Fibroin](#), [Cellulase](#)

Fibroin

Silkworm **fibroin** ([Figure 6.12](#)) contains long regions of antiparallel β sheet, with the polypeptide chains running parallel to the fiber axis. The β sheet regions comprise almost exclusively multiple repetitions of the sequence

[Gly - Ala - Gly - Ala - Gly - Ser - Gly - Ala - Ala - Gly - (Ser - Gly - Ala - Gly - Ala - Gly)₈]

Almost every other residue in the β sheet region of **fibroin** is [glycine](#) and between them lie either [alanine](#) or [serine](#) residues. This alternation allows the sheets to fit together and pack on top of one another in the manner shown in [Figure 6.12](#). The arrangement results in a fiber that is strong and relatively inextensible, because the covalently bonded chains are stretched to nearly their maximum possible length. Yet the fibers are very flexible, because bonding between the sheets involves only the weak van der Waals interactions between the side chains, which provide little resistance to bending.

Not all of the **fibroin** protein is in β -sheets. As the amino acid composition in [Figure 6.12](#) shows, **fibroin** contains small amounts of other, bulky amino acids like [valine](#) and [tyrosine](#), which would not fit into the structure shown. These are carried in compact folded regions that periodically interrupt the β -sheet segments, and they probably account for the amount of stretchiness that silk fibers have. In fact, different species of silkworms produce **fibroins** with different extents of such non - β -sheet structure and corresponding differences in elasticity. The overall **fibroin** structure is a beautiful example of a protein molecule that has evolved to perform a particular function-to provide a tough, yet flexible fiber for the silkworm's cocoon or the spider's web.

See also: [Fibrous Proteins](#)

Figure 6.12: The structure of silk fibroin.

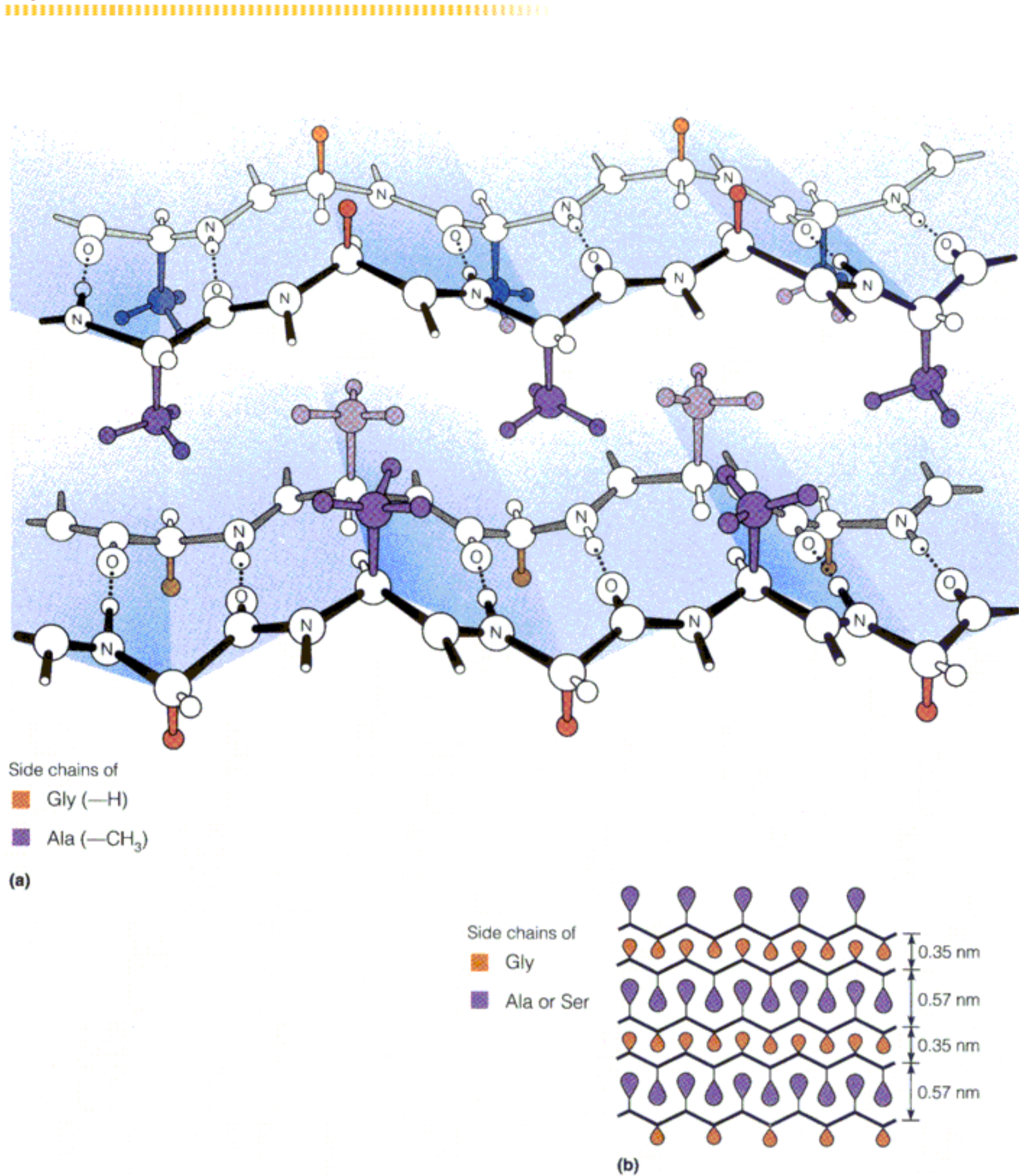

D-Glutamic Acid

D-Glutamic acid is found in the polypeptides of some bacterial cell walls ([Figure 9.26](#)) and may function to protect the bacterium against attack by peptidases.

See also: [D-Amino Acids](#), [Amino Acids Not In Proteins](#)

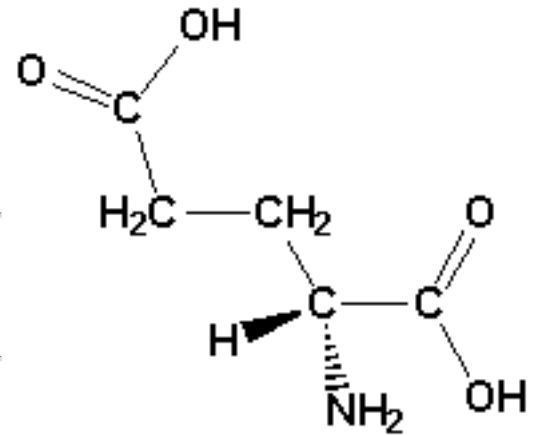

D-glutamic acid

Amino Acids Not Found in Proteins



<u>S-Adenosylhomocysteine</u>	<u>Citrulline</u>	<u>L-Homoserine</u>
<u>S-Adenosylmethionine</u>	<u>β-Cyanoalanine</u>	<u>L-Ornithine</u>
<u>β-Alanine</u>	<u>D-Glutamic Acid</u>	<u>Sarcosine</u>
<u>D-Alanine</u>	<u>γ Amino butyric acid (GABA)</u>	<u>L-Thyroxine</u>
<u>Azaserine</u>	<u>Homocysteine</u>	

S-Adenosylhomocysteine

S-adenosylmethionine ([AdoMet](#)) is a metabolically activated form of methionine involved in donating methyl groups. Transfer of a methyl group from AdoMet to a target molecule converts AdoMet to **S-Adenosylhomocysteine (AdoHcy)** (see [here](#)).

[Table 21.1](#) lists some important **AdoMet**-dependent transmethyations. Substrates range from small metabolites, such as [norepinephrine](#) (see reaction [here](#)) to polymers, such as DNA (see [here](#)), RNA, or proteins.

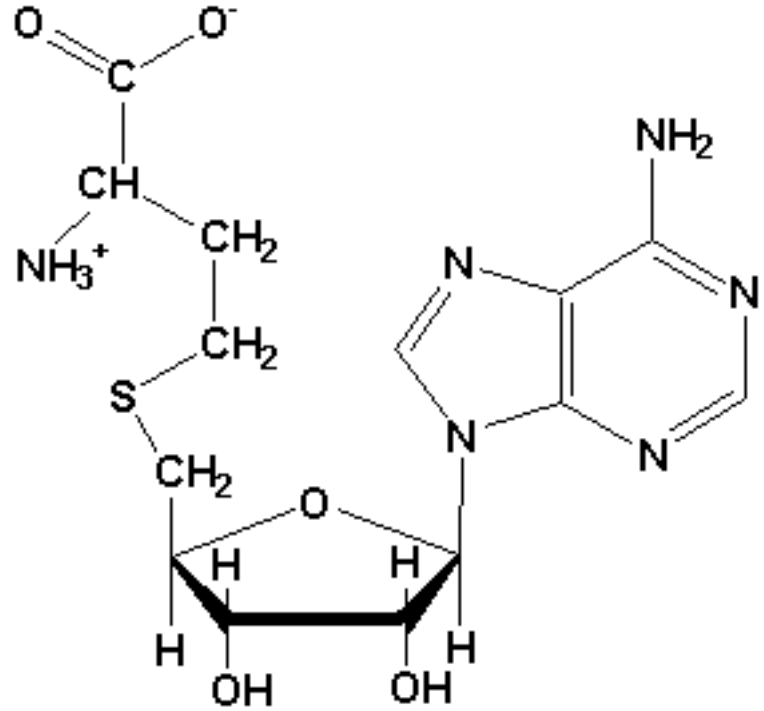

S-Adenosylhomocysteine

See also: [Methionine](#), [S-Adenosylmethionine and Biological Methyations](#), [Amino Acids Not In Proteins](#)

S-Adenosylmethionine (S-AdoMet)

S-Adenosylmethionine (AdoMet) is a metabolically activated form of **methionine** involved in donating methyl groups. **AdoMet** is formed in the reaction shown [here](#). Transfer of a methyl group from **AdoMet** to a target molecule converts **AdoMet** to S-Adenosylhomocysteine (**AdoHcy**) (see [here](#)). [Table 21.1](#) lists some important **AdoMet**-dependent transmethylation reactions. Substrates range from small metabolites, such as **norepinephrine** (see reaction [here](#)) to polymers, such as DNA (see [here](#)), RNA, or proteins.

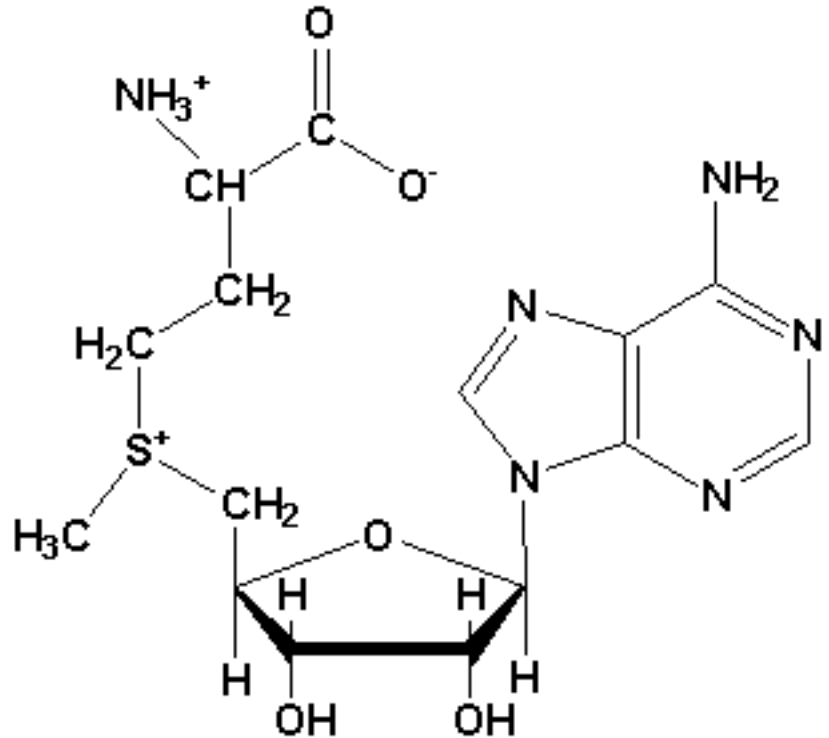

S-Adenosylmethionine (S-AdoMet)

See also: [S-Adenosylmethionine and Biological Methylations](#), [Ribonucleotide Reductase](#), [DNA Methylation](#), [Amino Acids Not In Proteins](#)

Methionine

Methionine is an α **amino acid** found in proteins. In mammals, **methionine** is an essential amino acid, meaning it must be present in the diet.

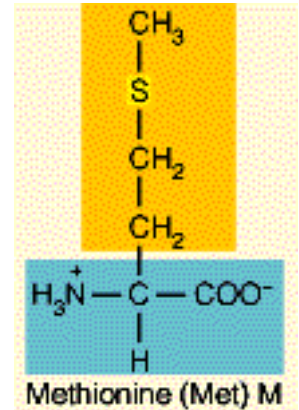

The hydroxy- and sulfur-containing amino acids are generally more hydrophilic than their aliphatic analogs, although **methionine** is fairly hydrophobic.

In the genetic code, **methionine** is coded for by the codon AUG. This codon is called the start codon because **methionine** is the first amino acid used to build a protein chain. **Methionine** forms the so-called amino terminus of a protein. In prokaryotes, a modified form of **methionine**, formyl-methionine is used as the first (but not subsequent) amino acid in proteins. Formyl-methionine is carried by a modified **tRNA** from the tRNA that carries unmodified **methionine**.

One Letter Code	Three Letter Code	Molecular Wt. (Daltons)	Genetic Code Codons
M	MET	131.21	AUG

See also: [Table 5.1, Genetic Code](#), [tRNA](#), [Metabolism of Sulfur-Containing Amino Acids](#), [Essential Amino Acids](#), [Translation Overview](#), [Initiation of Translation](#)

INTERNET LINK: [Methionine Metabolism](#)

Metabolism of Sulfur-Containing Amino Acids

Inorganic sulfur in the environment (primarily sulfate, but also sulfur, and sulfite) must undergo fixation to be utilized by organisms. The fixation of sulfate is largely confined to plants and bacteria. Fixation begins with the formation of **PAPS** (3'-phosphoadenosine-5'-phosphosulfate) (see [here](#)). PAPS is formed in a two-step reaction from sulfate ion and two molecules of ATP (see [here](#)).

PAPS is an activated sulfate compound and is an intermediate in all organisms for sulfate esterification, such as the synthesis of **chondroitin sulfate**.

In bacteria PAPS is a substrate for sulfate reduction. In plants, **adenosine-5'-phosphosulfate** is the substrate. **Thioredoxin**, a small thiol-containing protein, reduces the sulfate in PAPS to sulfite (SO₃²⁻). Sulfite is reduced by sulfite reductase in a six electron transfer through the intermediates **NADPH**, **FAD**, **FMN**, an iron-sulfur center, and the porphyrin **siroheme**. The end product is H₂S.

Bacteria and Plants - Bacteria and plants use H₂S to synthesize **cysteine**, which is then metabolized to make **methionine** ([Figure 21.5](#), [Figure 21.6](#)).

Some bacteria link **serine** to H₂S (see [here](#)) to make **cysteine** (Cys). However, plants and most bacteria react **β-O-acetyserine** with H₂S to make cysteine, as shown [here](#).

Animals - Mammals require **methionine** (Met) in their diets (i.e., Met is an **essential amino acid**) and Cys can be made from Met, as shown in [Figure 21.7](#). Thus, Cys is nonessential as long as sufficient Met is present in the diet. Mammals make Met from **homocysteine**, as shown in the reaction [here](#). [Figure 21.8](#) shows the pathway from Met to Cys and reveals that it is quite similar to the reverse of the methionine synthesis pathway in bacteria shown in [Figure 21.5](#). Plants and bacteria also use the pathway shown in [Figure 21.8](#) so they can synthesize one from the other, depending on their immediate needs. Methionine can also be made by conversion of **choline**, as shown [here](#).

Cystathionine (made by **cystathionine synthase** from **homocysteine** and **serine**) plays a central role both in the biosynthesis of methionine in plants and bacteria and in the biosynthesis of cysteine in animals. In humans, deficiency of cystathionine synthase leads to a condition called homocystinuria, in which **homocysteine** overaccumulates. The condition results in severe mental retardation and dislocation of the lens of the eye.

The principal catabolic pathways for Cys and Met are outlined in [Figure 21.11](#).

See also: [Metabolism of Glutathione](#), [S-Adenosylmethionine and Biological Methylation](#)

INTERNET LINKS:

1. [Sulfur Metabolism](#)
 2. [Methionine Metabolism](#)
 3. [Cysteine Metabolism](#)
-

3'-Phosphoadenosine-5'-Phosphosulfate

Inorganic sulfur in the environment (sulfate, sulfur, or sulfite) must undergo fixation to be utilized by organisms. The process for sulfate is largely confined to plants and bacteria. Activation of sulfur for reduction is in the form of the intermediate called **PAPS** (**3'-phosphoadenosine-5'-phosphosulfate**) (see [here](#)). **PAPS** is formed in a two-step reaction (see [here](#)).

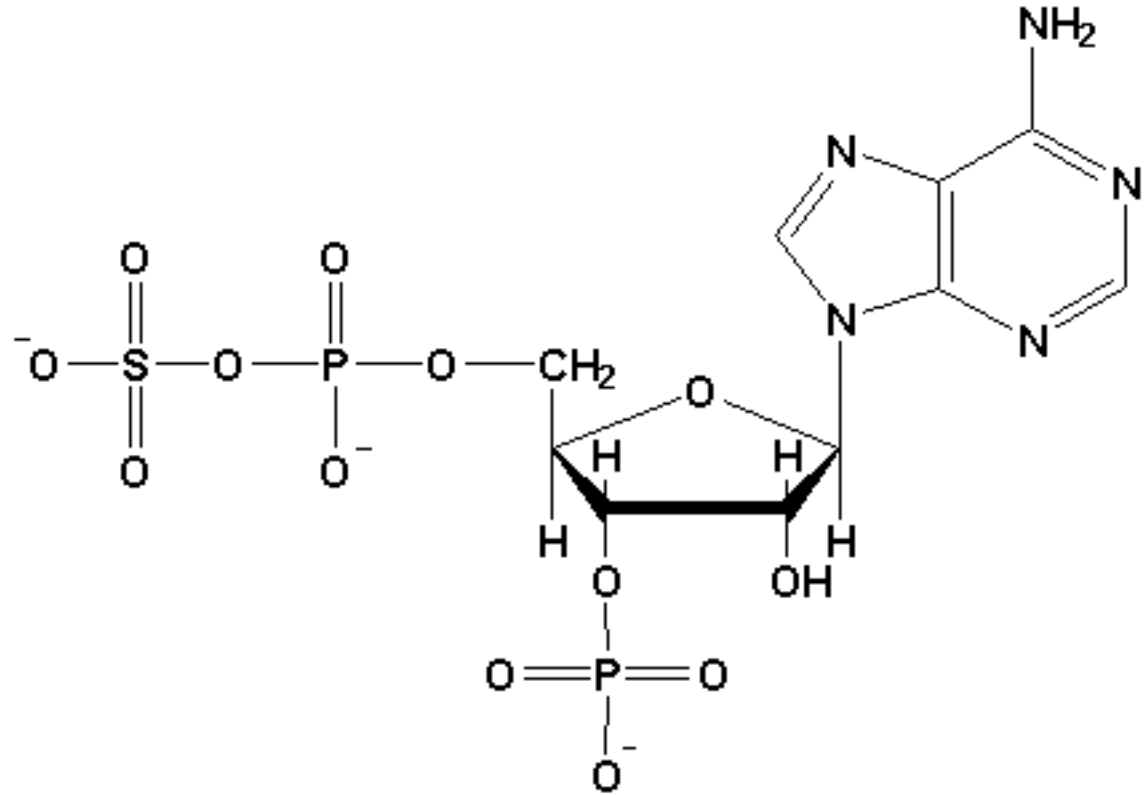

3'-Phosphoadenosine-5'-phosphosulfate

See here: [Metabolism of Sulfur-Containing Amino Acids](#)

Unnumbered Item

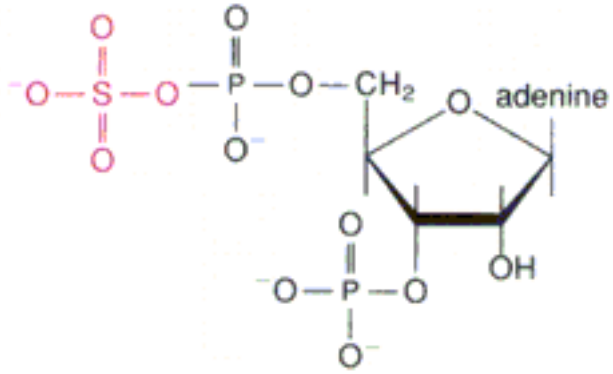

3'-Phosphoadenosine-5'-phosphosulfate

Unnumbered Item

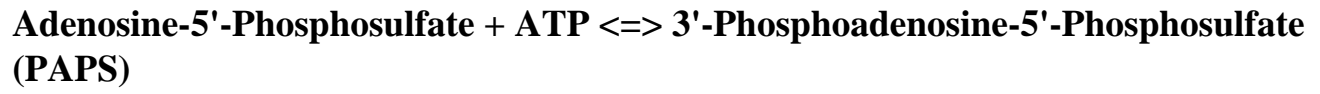

Chondroitin Sulfates

Chondroitin sulfates ([Figure 9.23](#)) are molecules classified as [glycosaminoglycans](#). Two common **chondroitin sulfates** are **chondroitin-4-sulfate** and **chondroitin-6-sulfate**. Each is a polymer of alternating units of [D-glucuronate](#) and [N-acetyl-D-galactosamine-sulfate](#) linked in a β 1-3 linkage. The only differences between the polymers are that **chondroitin-4-sulfate** has the sulfate on position 4 of the N-acetyl-D-galactosamine molecule whereas the sulfate is on position 6 in **chondroitin-6-sulfate**.

Core proteins in cartilage have **chondroitin sulfate** and keratan sulfate chains covalently bound to them through [serine](#) side chains. In cartilage, this kind of structure binds [collagen](#) and helps hold the collagen fibers in a tight, strong network. The binding apparently involves electrostatic interactions between the sulfate and/or carboxylate groups of the proteoglycan complex and the basic side chains in collagen.

See also: [Figure 9.24b](#), [Polysaccharides](#), [Dermatan Sulfates](#), [Keratan Sulfates](#)

Figure 9.23: Repeating structures of some glycosaminoglycans.

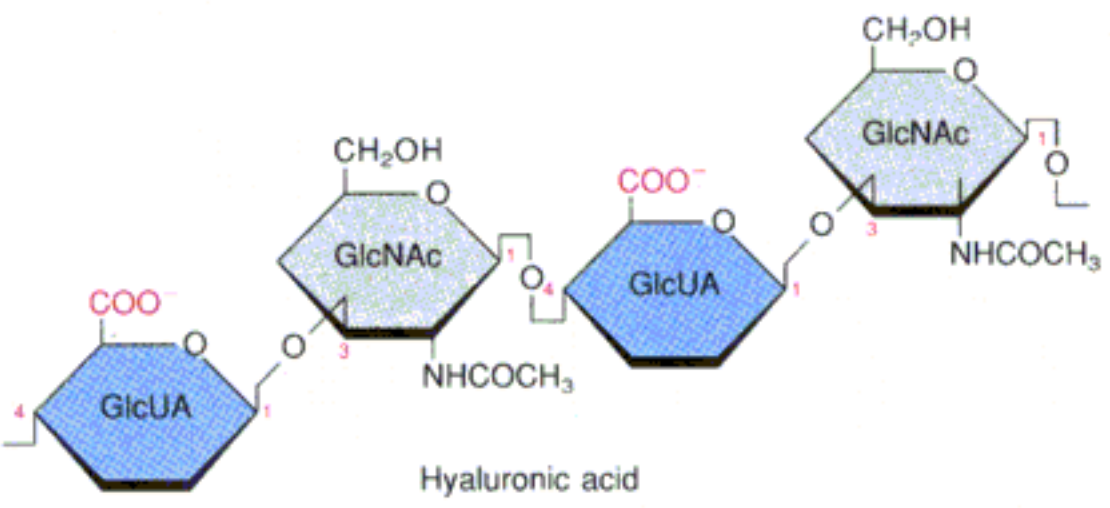
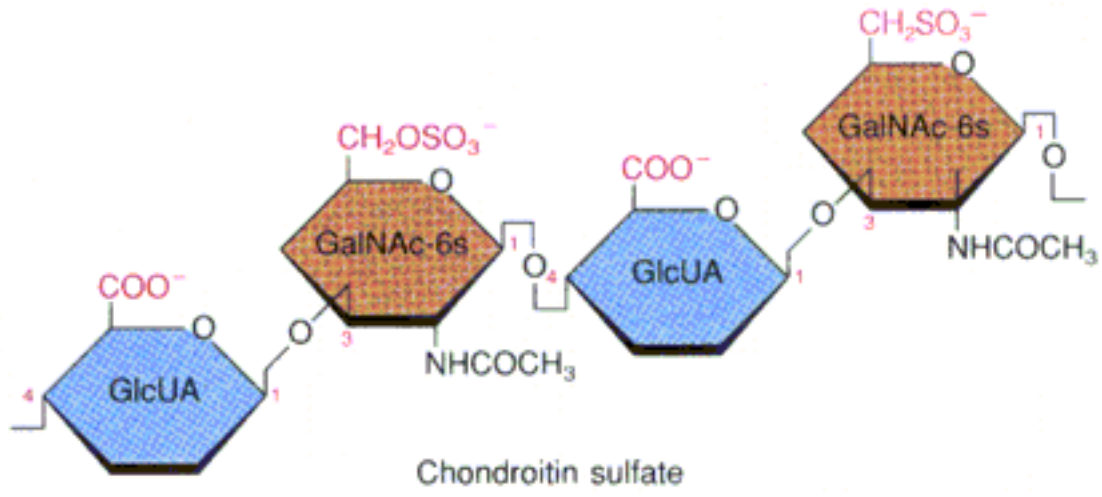

Glycosaminoglycans

Glycosaminoglycans are polysaccharides containing alternating residues of uronic acid and amine derivatives of hexoses (such as N-acetylglucosamine). Typically the repeating unit carries a carboxyl group and often one or more sulfates, so that most **glycosaminoglycans** have a high density of negative charges. **Glycosaminoglycans** are often combined with protein to form proteoglycans and are an important component of the extracellular matrix of vertebrates.

Glycosaminoglycans provide structural support in vertebrates. Several **glycosaminoglycans** are listed in the following table.

Chondroitin sulfates

Hyaluronic Acid

Keratan sulfates

Heparin

Dermatan sulfates

Peptidoglycans

Glycosaminoglycans are sometimes called mucopolysaccharides.

See also: Proteoglycans, Figure 9.23, Figure 9.24b

Polysaccharides

Polysaccharides are polymers of **monosaccharide** units. The monomeric units of a **polysaccharide** are usually all the same (called homopolysaccharides), though there are exceptions (called heteropolysaccharides). In some cases, the monomeric units are modified monosaccharides.

Polysaccharides differ in the composition of the monomeric unit, the linkages between them, and the ways in which branches from the chains occur. Common polymers, their monomeric units, and linkages/branches are shown below:

Polysaccharide Name	Monomeric Unit	Linkages
<u>Glycogen</u>	D- <u>Glucose</u>	α 1->6 branches
<u>Cellulose</u>	D- <u>Glucose</u>	β 1->4
<u>Chitin</u>	<u>N-Acetyl-D-glucosamine</u>	β 1->4
<u>Amylopectin</u>	D- <u>Glucose</u>	α 1->6 branches
<u>Amylose</u>	D- <u>Glucose</u>	α 1->4

Linkages between the individual units require special enzymes to break them down. For example, the α 1-> 4 linkages between glucose units in glycogen, amylose, and amylopectin, are readily broken down by all animals, but only ruminant animals (cows, horses, etc.) contain symbiotic bacteria with an enzyme (cellulase) that can break down the β 1-> 4 linkages between individual glucose units in cellulose. As a result, the huge amount of cellulose in the biosphere is unavailable as an energy source to most animals.

The secondary structure of the **polysaccharides** range from the helical structure of amylose (**Figure 9.20**) to the planar structure of cellulose (**Figure 9.21**). Branching affects the secondary structure of a **polysaccharide**, as shown for amylopectin in **Figure 9.19**.

Polysaccharides are used to some extent for energy storage in almost all higher organisms. Animals use glycogen. Plants use starch, which is composed of amylose and amylopectin. In both plants and animals, the **polysaccharides** used for energy storage are readily broken down into monomeric units that can be rapidly metabolized to produce ATP. In addition to **polysaccharides** used for energy storage, plants use different **polysaccharides**, such as cellulose, for structural purposes in their cell walls. The exoskeleton of many arthropods and mollusks is composed of chitin, a **polysaccharide** of N-acetyl-D-glucosamine.

Polysaccharides containing a single sugar, such as glucose, are referred to as glucans. Others, which contain only mannose, are called mannans. Still others, containing only xylose, are called xylans.

Another group of **polysaccharides** of importance is the glycosaminoglycans. These are

heteropolysaccharides containing either [N-acetylgalactosamine](#) or N-acetylglucosamine as one of their monomeric units. Examples include [chondroitin sulfates](#) and [keratan sulfates](#) of connective tissue, [dermatan sulfates](#) of skin, and [hyaluronic acid](#). All of these are acidic, through the presence of either sulfate or carboxylate groups. Examples are shown in [Figure 9.23](#).

[Hyaluronic Acid](#) also acts in the body as a viscosity-increasing agent or lubricating agent in the vitreous humor of the eye and synovial fluid of joints.

[Heparin](#) is yet another highly sulfated glycosaminoglycan. Part of the repeating unit of its complex chain is shown [here](#). Heparin is used medicinally to inhibit clotting in blood vessels.

Bacteria contain polysaccharides in their cell walls in the form of peptidoglycans. In the case of Gram-positive bacteria, the long polysaccharide chains are strictly alternating copolymers of N-acetylglucosamine (NAG) and [N-acetylmuramic Acid](#) (NAM). A tetrapeptide is attached to the lactic acid moiety of the NAM.

See also: [Saccharides](#), [Structural Polysaccharides](#), [Oligosaccharides](#), [Monosaccharide Nomenclature](#), [Biosynthesis of Polysaccharides](#) (from Chapter 16), [Biosynthesis of Other Polysaccharides](#) (from Chapter 16), [Biosynthesis of Amino Sugars](#) (from Chapter 16), [Biosynthesis of Glycoconjugates](#) (from Chapter 16)

Glycogen

Glycogen is a branched polymer of [glucose](#), consisting of main branches of glucose units joined in $\alpha(1\text{-} >4)$ linkages. Every 7-20 residues, $\alpha(1\text{-} >6)$ branches of glucose units are also present. **Glycogen** is a primary energy storage material in muscle. Individual glucose units are cleaved from glycogen in a phosphorolytic mechanism catalyzed by [glycogen phosphorylase](#).

The storage polysaccharides, such as **glycogen**, are admirably designed to serve their function. Glucose and even [maltose](#) are small, rapidly diffusing molecules, which are difficult to store. Were such small molecules present in large quantities in a cell, they would give rise to a very large cell osmotic pressure, which would be deleterious in most cases. Therefore, most cells build the glucose into long polymers, so that large quantities can be stored in a semi-insoluble state. Whenever glucose is needed, it can be obtained by selective degradation of the polymers by specific enzymes.

See also: [Phosphorolysis](#), [Glycogen phosphorylase](#), [Figure 13.18](#), [Kinase Cascade](#), [Figure 13.16](#), [Figure 13.17](#), [Polysaccharides](#), [Glycogen Breakdown](#), [Hydrolysis vs Phosphorolysis](#) [Glycogen Breakdown Regulation](#)

Oligosaccharides

Glycosidic bonds between **monosaccharides** give rise to **oligosaccharides** and **polysaccharides**. The simplest **oligosaccharides**, the **disaccharides**, include compounds such as **sucrose** and **lactose**, which are referred to as sugars (like the monosaccharides). Other common disaccharides include **trehalose**, **maltose**, **gentiobiose**, and **cellobiose**.

Four features distinguish disaccharides from each other:

1. The two specific sugar monomers and their stereoconfigurations
2. The carbons involved in the linkage
3. The order of the monomeric units, if they are different kinds
4. The anomeric configuration of the hydroxyl group on carbon 1 of each residue

Table 9.4 shows abbreviations for the common monosaccharides. The naming rules for oligosaccharides based on these abbreviations are as follows:

1. The sequence starts with the nonreducing end at the left using the abbreviations of **Table 9.4**
2. Anomeric and enantiomeric forms are designated by prefixes (e.g., α , D-)
3. The ring configuration is designated by the suffixes p (pyranose) or f (furanose)
4. Numbers in parentheses between residue numbers are used to identify glycosidic bonds; e.g., (1->4) means a bond from carbon 1 of the residue on the left to carbon 4 of the residue on the right.

Thus, α -D-Glcp(1->2)- β -D-Fruf corresponds to sucrose.

Oligosaccharides are also found as part of **glycoproteins** and play a role in cell recognition/identity. **Oligosaccharides** form the blood group antigens. In some cells, these antigens are attached as O-linked glycans to membrane proteins. Alternatively, the **oligosaccharide** may be linked to a lipid molecule to form a glycolipid. These **oligosaccharides** determine the blood group types in humans (**Figure 9.29**).

See also: [Saccharides](#), [Oligosaccharides as Cell Markers](#), [Biosynthesis of Glycoconjugates](#) (from Chapter 16), [Diastereomers](#), [Monosaccharide Nomenclature](#)

Glycosides and Glycosidic Bonds

Glycosides are formed by elimination of water between the anomeric hydroxyl of a cyclic [monosaccharide](#) and the hydroxyl group of another compound (see [here](#)). **Glycosides** do not undergo mutarotation (see [here](#)) in the absence of an acid catalyst, so they remain locked in the α or β configuration. (Remember that the hydroxyl group on the anomeric carbon can undergo a change in orientation from the α to β position, or vice versa. This change is called mutarotation). **Glycosidic bonds** are very common in plant and animal tissues. Many **glycosides** are known. Some, such as [ouabain](#) or [amygdalin](#) ([Figure 9.15](#)) are very poisonous. Others, such as the common oligosaccharides and polysaccharides found in our cells, are not.

See also: [Sugar Ring Structures](#), [Derivatives of Monosaccharides](#), [Oligosaccharides](#), [Polysaccharides](#), [Anomers](#), [Ouabain](#), [Amygdalin](#), [Mutarotation](#)

INTERNET LINK: [Chemical Synthesis of Glycosides](#)

Unnumbered Item

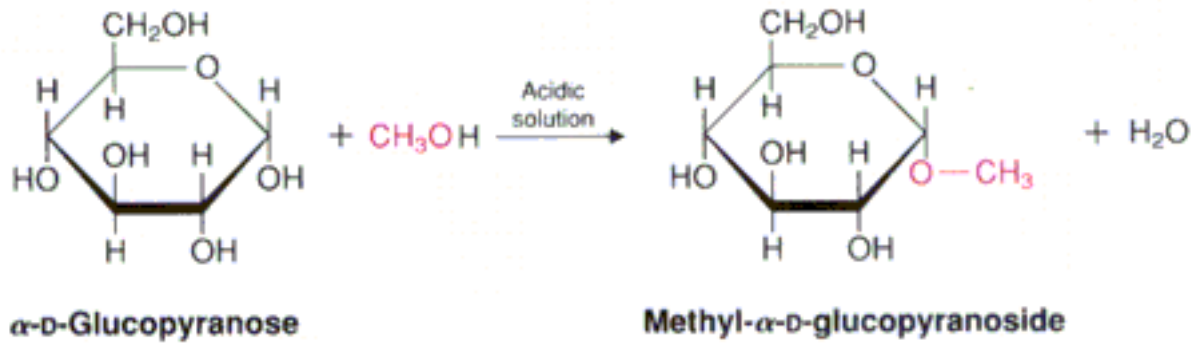

Mutarotation



Mutarotation is a process whereby the configuration of an anomeric carbon converts from α to β or vice-versa.

See also: [Sugar Ring Structures](#), [Diastereomers](#)

Anomers

Anomers are stereoisomers of cyclized monosaccharide molecules differing only in the configuration of the newly created center of chirality arising from the cyclization ([Figure 9.14](#)).

The carbon of a newly created center of chirality arising from the cyclization of a sugar is called an **anomeric carbon**.

Anomerization occurs to the ribose sugar moiety during *de novo* purine nucleotide biosynthesis.

See also: [Sugar Ring Structures](#), [Diastereomers](#), [Mutarotation](#), [De Novo Biosynthesis of Purine Nucleotides](#)

Figure 9.14: Terminology describing the structure of sugar molecules.

Enantiomers

Stereoisomers that are mirror images of one another

The boxed asymmetric carbon (farthest from aldehyde) determines D/L designation

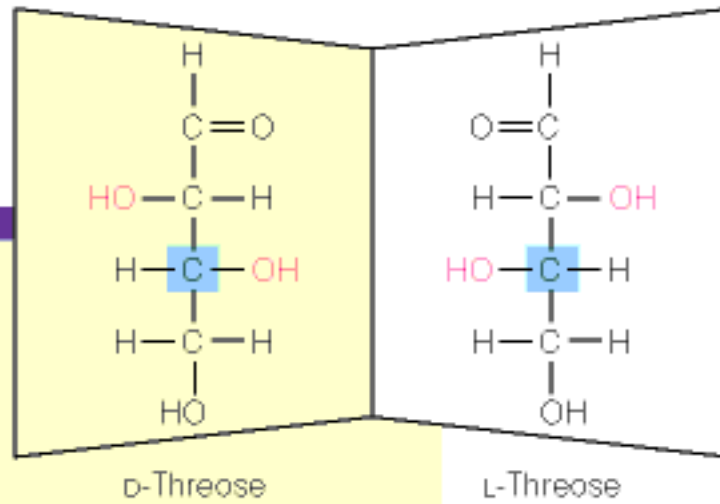

Diastereomers

Stereoisomers that are not mirror images of one another

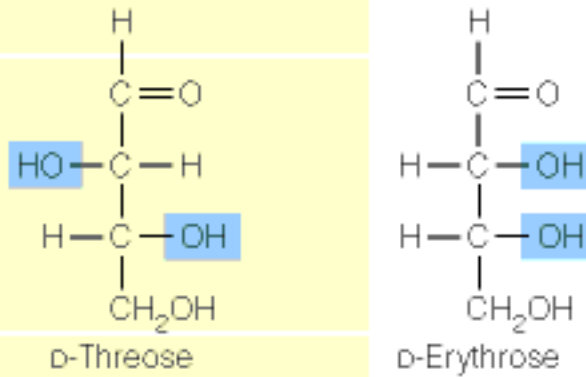

Anomers

Stereoisomers that differ in configuration at the anomeric carbon

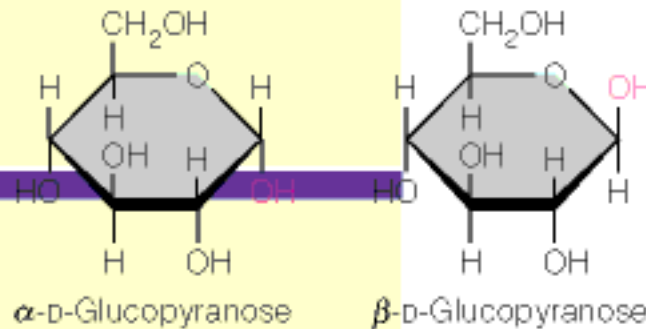

Conformational isomers

Molecules with the same stereochemical configuration, but differing in three-dimensional conformation

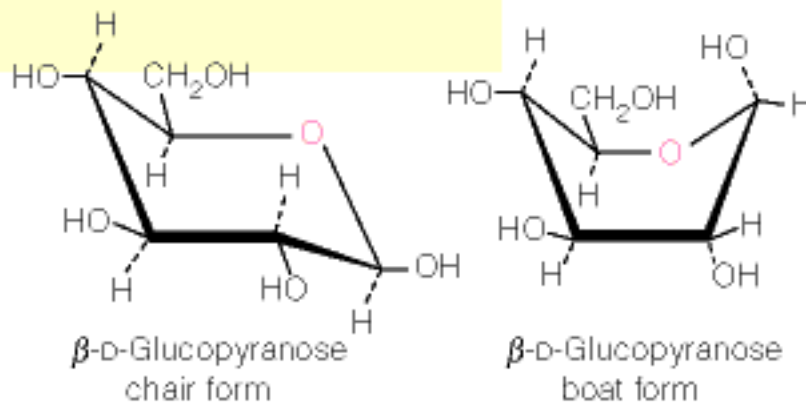

β -D-Glucopyranose^H
chair form

β -D-Glucopyranose
boat form

Sugar Ring Structures

When sugars cyclize, they typically form furanose or pyranose structures ([Figure 9.10](#)). These are molecules with five-membered or six-membered rings, respectively. When cyclization happens, the carbon which contained the aldehyde or ketone group is typically linked to the oxygen on carbon 4 or 5 of the linear sugar structure. In the process, the aldehyde or ketone group is converted to a hydroxyl and the carbon to which it is attached becomes chiral. Thus, there are two possible orientations of the hydroxyl around the new chiral carbon. We refer to this carbon as the anomeric carbon and the two possible forms as [anomers](#). The two possible configurations of the hydroxyl group are called α and β , which correspond to the hydroxyl being in the "down" and "up" positions, respectively, in standard projections (see [here](#)). Anomers are capable of interconverting between α and β positions in a process is called mutarotation.

Sugar ring structures can be written in a variety of ways. The most common forms are the [Haworth projections](#) ([Figure 9.10](#)) and the [Fischer projections](#) (see [here](#)). Note that both of these planar representations are inaccurate. [Figure 9.11](#) shows a 3D projection of a furanose. Notice that all of the atoms of the ring do not fit into the same plane. Flexing of the atoms in the ring can give rise to rings with slightly different shapes. Note the very different orientations of carbon #3 in [Figure 9.11a and 9.11b](#). These are called [conformational isomers](#) because they have the same chemical composition and the same atoms are bonded to each other, but slightly different bond angles give rise to different structural conformations.

[Figure 9.13](#) shows that a pyranose, such as [glucose](#), has two common conformational isomers, referred to as the "boat" and "chair" form. For glucose (and most sugars), the chair form is more stable because the hydroxyls of carbons 1 and 2 are further removed and thus have less steric interference with carbons 3, 4, and 5.

See also: [Monosaccharide Nomenclature](#), [Figure 9.14](#), [Monosaccharides](#)

Figure 9.10: Formation of ring structures by pentoses.

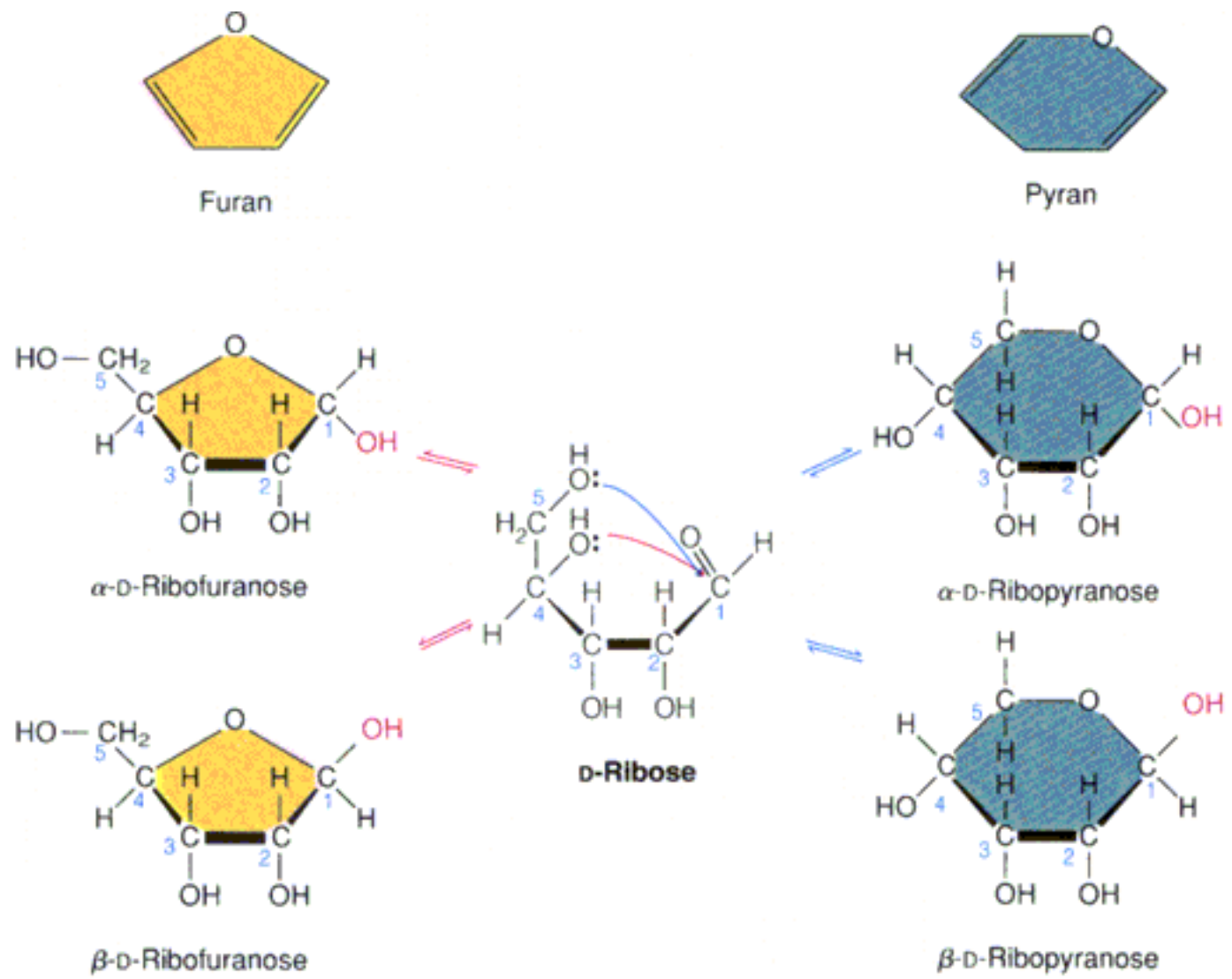

Unnumbered Item

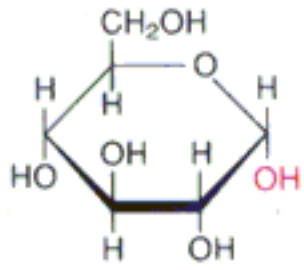

α -D-Glucopyranose

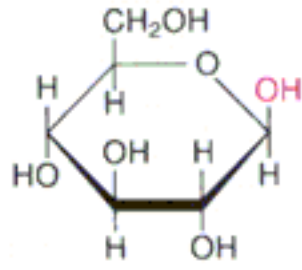

β -D-Glucopyranose

Haworth Projection

A **Haworth projection** is a conventional planar representation of a cyclized **monosaccharide** molecule. The hydroxyls that are represented to the right of the chain in a Fischer projection are shown below the plane in a **Haworth projection**. **Glucose** is shown at the right in a **Haworth projection**.

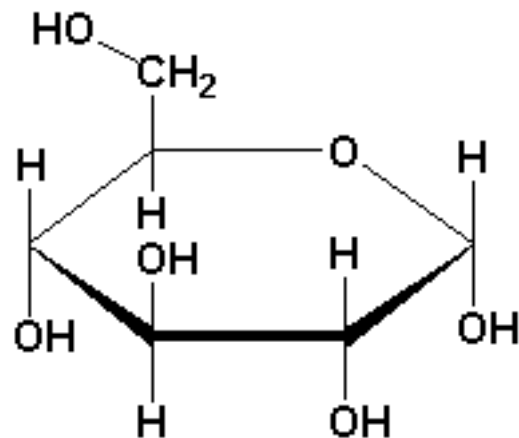

Glucose

See also: [Fischer Projection](#), [Diastereomers](#), [Sugar Ring Structures](#)

Diastereomers

Chiral carbons (carbons covalently linked to 4 different entities) give rise to stereoisomers. Molecules that are stereoisomers have the same formula and the same structure, but have their atoms arranged in different ways in 3D space. For example, compare the structures of D-glyceraldehyde and L-glyceraldehyde in [Figure 9.5](#). Notice that they are nonsuperimposable.

Common sugars typically have not one, but multiple chiral carbons. [Glucose](#), for example, contains four chiral carbons. For a carbon with 'm' chiral carbons, the number of possible stereoisomers is 2^m . Thus, for glucose, there are 16 possible stereoisomers. The form most commonly found in living organisms, D-glucose, has only one mirror image. In fact, any stereoisomer has only one mirror image. The other 14 stereoisomers of glucose that are not mirror images of it are called **diastereomers**. That is, **diastereomers** are stereoisomers that are not mirror images of each other.

Diastereomers can have very different biological uses. For example, [Figure 9.9a](#) shows the 8 D-stereoisomers of D-glucose. Some of these, such as [galactose](#) and [mannose](#), are commonly found in biological systems. Others, such as [D-idose](#) or [D-talose](#), are much rarer.

See also: [Saccharides](#), [Monosaccharide Nomenclature](#), [Glucose](#), [Galactose](#), [Mannose](#)

Figure 9.5: The enantiomers of glyceraldehyde.

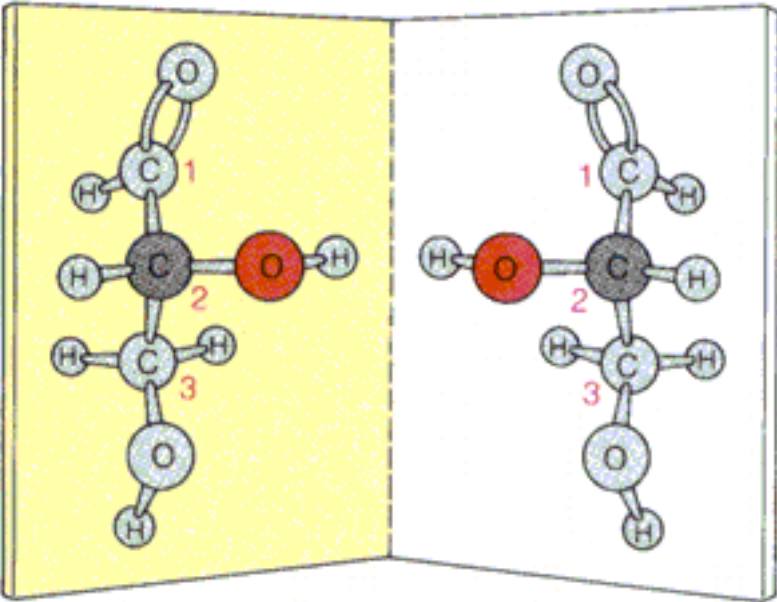

D-Glyceraldehyde

L-Glyceraldehyde

Galactose

Galactose is a **monosaccharide**. It contains six carbons and an aldehyde group and is classified as an aldose and a hexose. Both the D and L forms are found in nature. The structure depicted at the right is the D isomer. **D-Galactose** is commonly found in milk as part of the disaccharide **lactose**. **L-Galactose** is present in **polysaccharides**, such as agar.

See also: [Galactose Operon](#), [Galactose Metabolism](#), [Diastereomers](#), [Saccharides](#), [cAMP Receptor Protein](#), [Monosaccharide Nomenclature](#)

INTERNET LINK: [Galactose Metabolism](#)

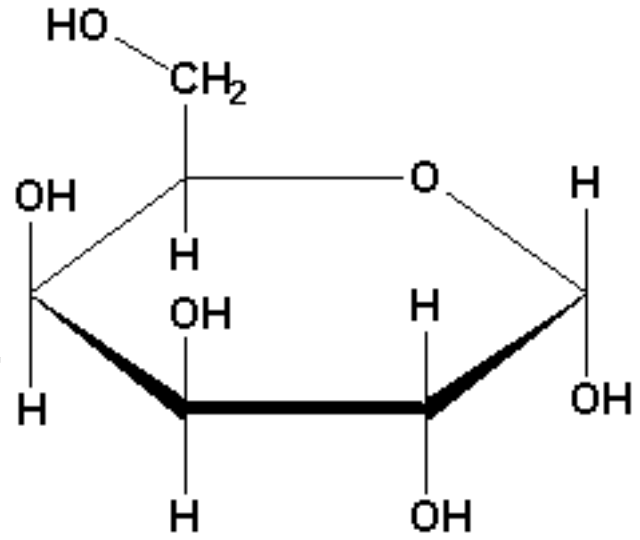

Galactose

Lactose

Lactose is a **disaccharide** composed of **galactose** and **glucose** linked as follows: Carbon number one of galactose (β configuration) is linked to carbon four of glucose. **Lactose** is formed as a result of the process shown in **Figure 9.17**.

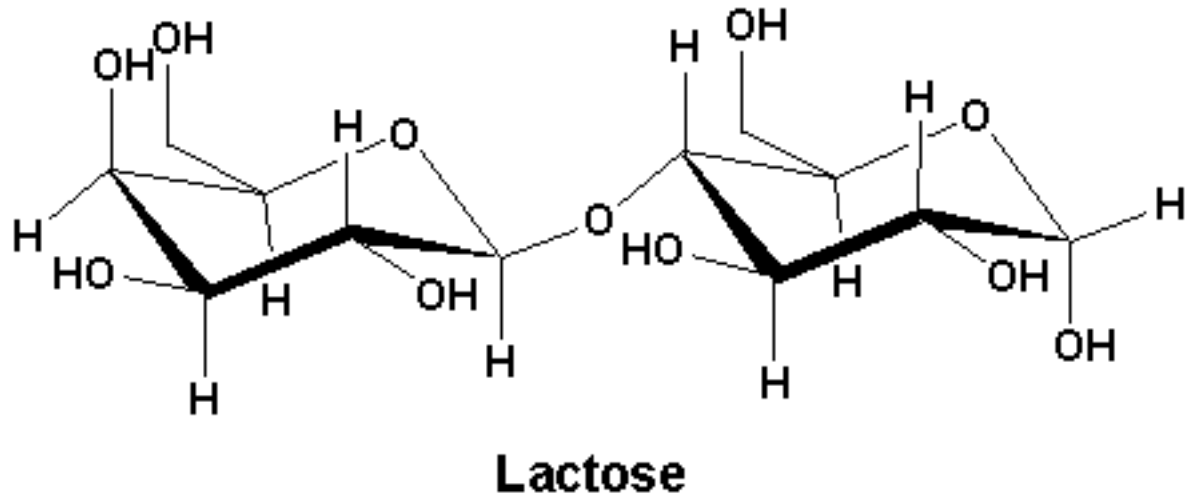

See also: [Lactose Intolerance](#), [\$\alpha\$ -Lactalbumin](#), [Lactose Synthase](#), [Regulation of the *Lac* Operon](#)

Figure 9.17: Formation of lactose in vivo.

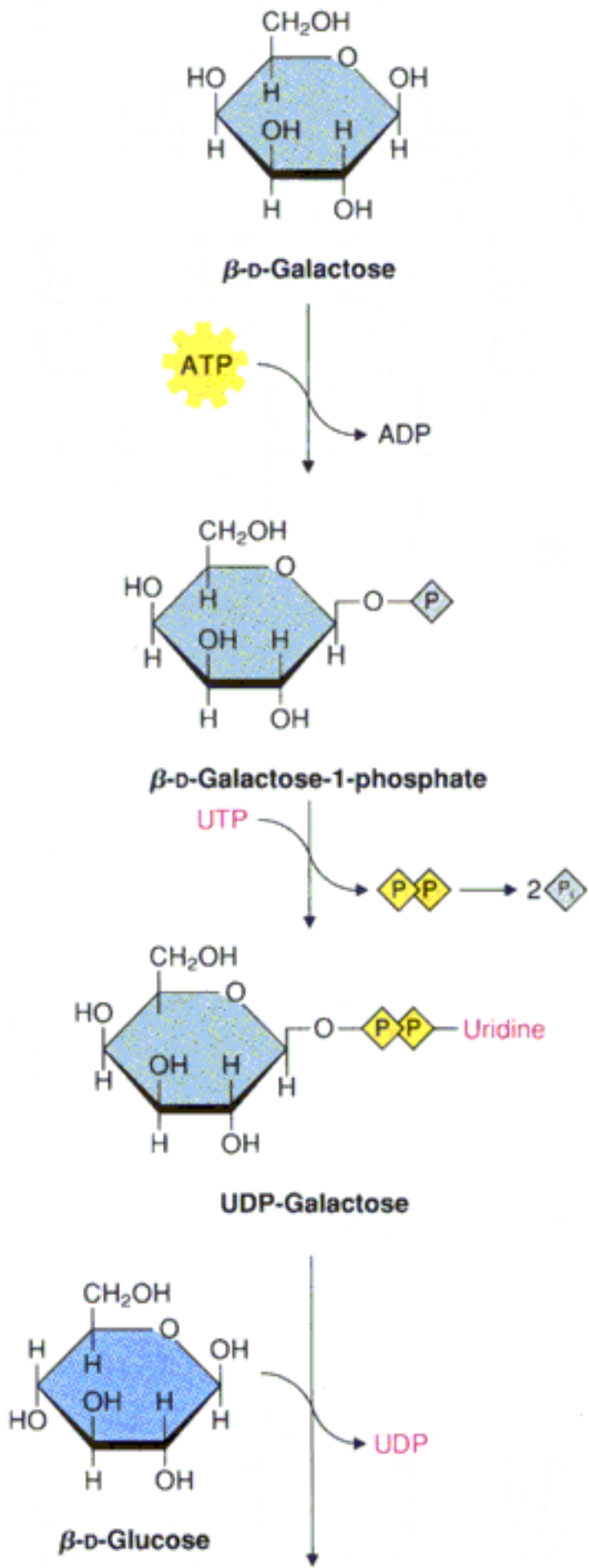

H OH
 β -D-Glucose

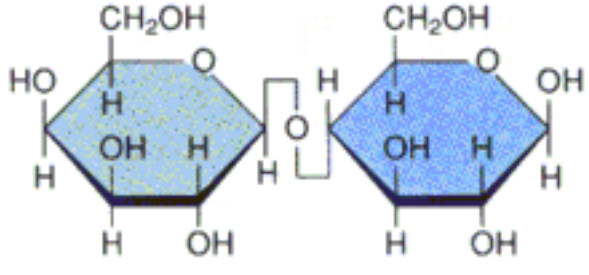

Lactose

Lactose Intolerance



In many humans the enzyme [lactase](#), which digests the milk sugar [lactose](#) to galactose and glucose, disappears from the intestinal mucosal cells after age 4 to 6, when milk drinking usually decreases. This causes **lactose intolerance**, a condition in which ingestion of milk or lactose-containing milk products causes intestinal distress, because of bacterial action on the lactose that accumulates.

See also: [Galactose](#), [Glucose](#)

INTERNET LINK: [Lactose.Net - Lactose Intolerance Resources](#)

Lactase



Lactase catalyzes the hydrolysis of lactose to galactose and glucose:



See also: [Lactose Intolerance](#)

α -Lactalbumin

N-acetyllactosamine is a constituent of the carbohydrate portion of glycoproteins. The synthetic reaction to make N-acetyl- β -lactosamine is catalyzed by galactosyltransferase:



The common form of the galactosyltransferase enzyme contains a single polypeptide subunit. The presence of an additional subunit changes the specificity of the galactosyltransferase enzyme so that lactose is synthesized instead.



This modified enzyme, termed Lactose Synthase, is found in animals only in mammary gland, where it synthesizes the major sugar of milk. The polypeptide that modifies the specificity of the enzyme is the mammary gland protein α -**lactalbumin**. Synthesis of α -**lactalbumin** is activated hormonally in mothers shortly after giving birth. The protein combines with preexisting galactosyltransferase, changes its specificity, and activates the large amount of lactose synthesis needed for milk production.

See also: UDP-Galactose, Lactose, Glucose, Lactose Synthase, N-acetyllactosamine, Figure 9.17

INTERNET LINK: Image of Lactalbumin (Slow)

N-Acetylglucosamine

The enzymes shown in **Figure 13.13** participate in mammary gland in the synthesis of **lactose** in milk. Lactose is formed from UDP-Gal plus glucose by **lactose synthase**, in the presence of the protein α -lactalbumin. The endergonic synthesis of UDP-Gal in this tissue proceeds smoothly because of its high rate of conversion to lactose.

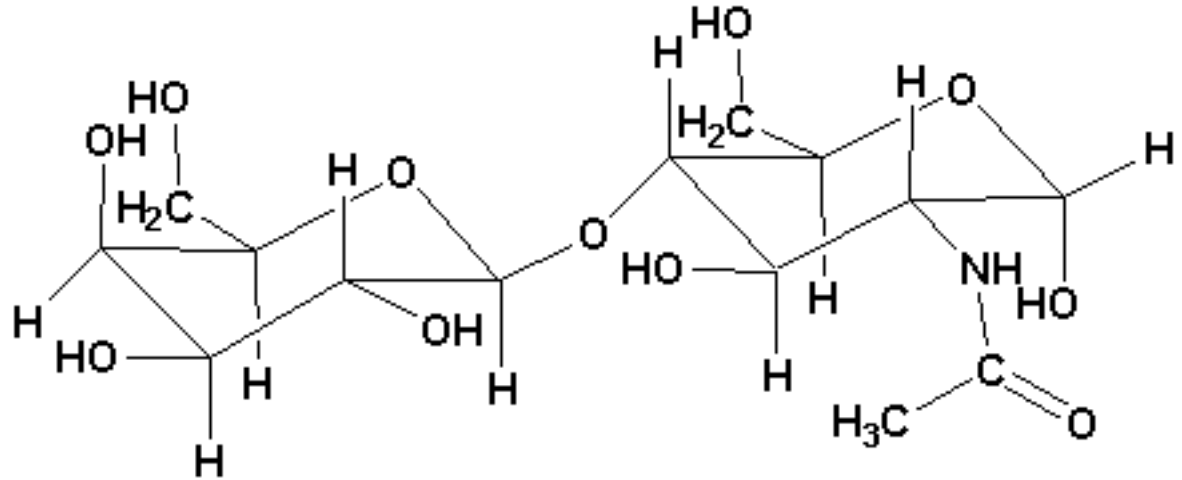

N-acetyl-beta-lactosamine

An enzyme called **galactosyltransferase** is closely related to lactose synthase. It catalyzes the reaction below.



The common form of the enzyme contains a single polypeptide subunit. The presence of an additional subunit, α -lactalbumin, changes the specificity of the enzyme so that lactose is synthesized instead.



This modified enzyme is lactose synthase. Synthesis of α -lactalbumin is activated hormonally in mothers shortly after giving birth. The α -lactalbumin protein combines with preexisting galactosyltransferase, changes its specificity, and activates the large amount of lactose synthesis needed for milk production.

See also: **Lactose**, **Glucose**, **α -Lactalbumin**,

Figure 13.13: Pathway for utilizing galactose by converting it to glucose-6-phosphate.

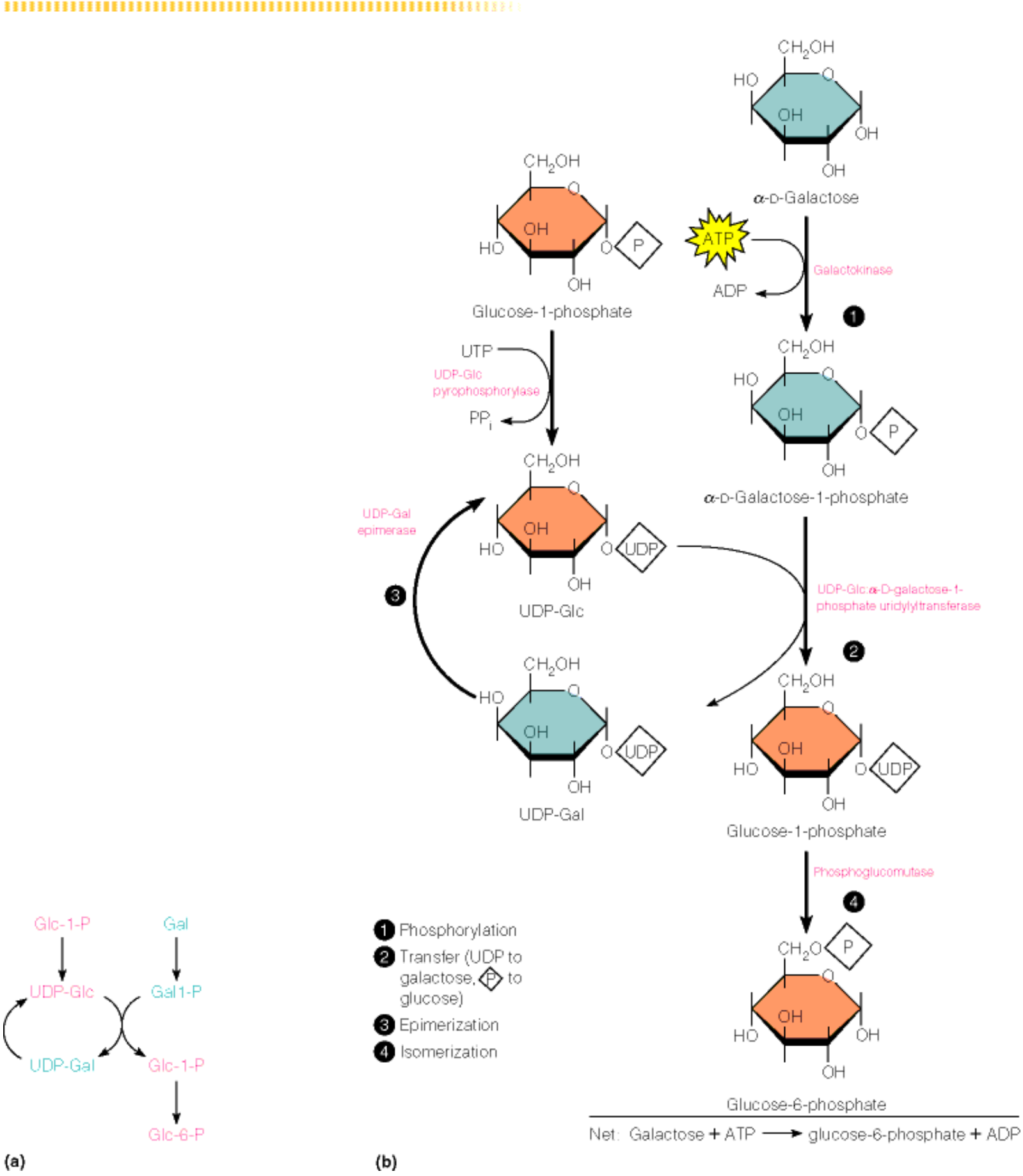

Lactose Synthase

The enzymes shown in [Figure 13.13](#) participate in mammary gland in the synthesis of lactose in milk. Lactose is formed from UDP-Gal plus glucose by **lactose synthase**, in the presence of the protein α -lactalbumin. The endergonic synthesis of UDP-Gal in this tissue proceeds smoothly because of its high rate of conversion to lactose.

An enzyme called [galactosyltransferase](#) is closely related to **lactose synthase**. It catalyzes the reaction below.



The common form of the enzyme contains a single polypeptide subunit. The presence of an additional subunit, [\$\alpha\$ -lactalbumin](#), changes the specificity of the enzyme so that lactose is synthesized instead.



This modified enzyme is **lactose synthase**. Synthesis of [\$\alpha\$ -lactalbumin](#) is activated hormonally in mothers shortly after giving birth. The α -lactalbumin protein combines with preexisting galactosyltransferase, changes its specificity, and activates the large amount of lactose synthesis needed for milk production.

See also: [Figure 9.17](#)

Galactosyltransferase

The synthetic reaction to make N-acetyl- β -lactosamine is catalyzed by **galactosyltransferase**.



The common form of **galactosyltransferase** contains a single polypeptide subunit. The presence of an additional subunit changes the specificity of the enzyme so that lactose is synthesized instead.



This modified enzyme, termed **lactose synthase**, is found in animals only in mammary gland, where it synthesizes the major sugar of milk. The polypeptide that modifies the specificity of the enzyme is the mammary gland protein α -**lactalbumin**. Synthesis of α -lactalbumin is activated hormonally in mothers shortly after giving birth. The protein combines with preexisting **galactosyltransferase**, changes its specificity, and activates the large amount of lactose synthesis needed for milk production.

See also: [Figure 9.17](#)

UDP-Galactose

UDP-Galactose is an intermediate in galactose metabolism, formed by the enzyme **UDP-glucose-4-epimerase**, which catalyzes release of glucose-1-phosphate from UDP-glucose in exchange for galactose-1-phosphate to make UDP-galactose.

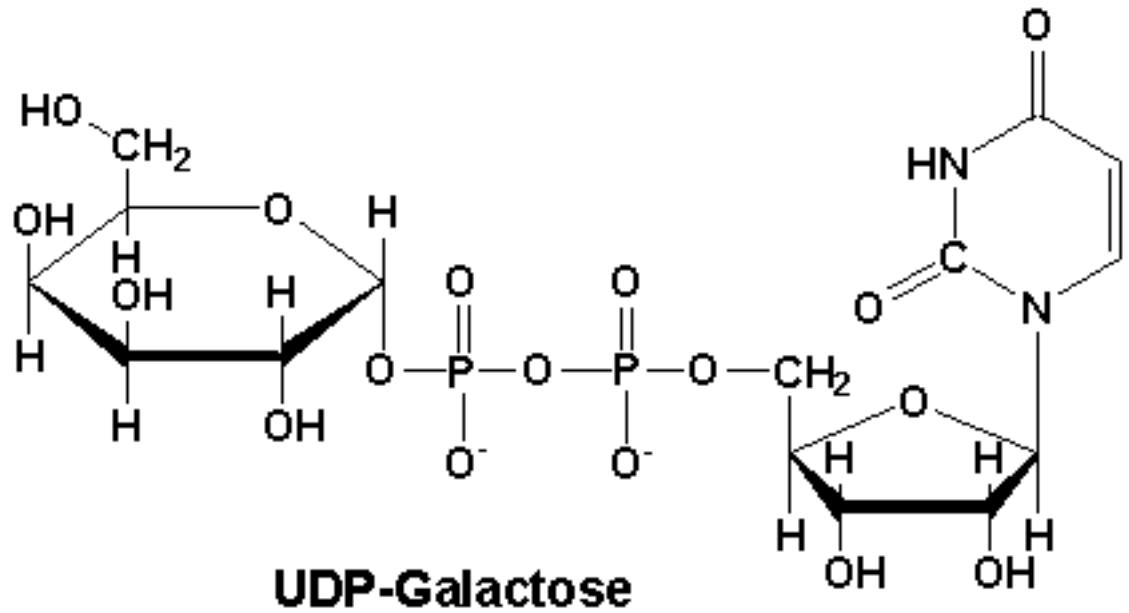

See also: [Galactose](#)

[Metabolism](#), [Glucose-1-Phosphate](#), [UDP-Glucose](#), [Galactose-1-Phosphate](#), [Figure 11.26](#), [Figure 9.17](#), [Figure 13.13](#)

UDP-Glucose- α -D-Galactose-1-Phosphate Uridylyltransferase

UDP-Glucose- α -D-galactose-1-phosphate uridylyltransferase (also called α -D-galactose-1-phosphate uridylyltransferase) catalyzes release of glucose-1-phosphate (G1P) from UDP-glucose in exchange for galactose-1-phosphate (Gal1P) to make UDP-galactose.

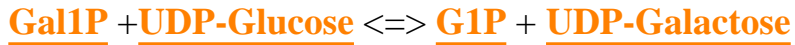

The enzyme functions in galactose metabolism.

See also: [Figure 13.13](#), [Galactose Metabolism](#)

Galactose-1-Phosphate

Galactose-1-phosphate is an intermediate in galactose metabolism derived by action of the enzyme **galactokinase** on ATP and **galactose**.

Galactose-1-phosphate subsequently exchanges with **glucose-1-phosphate** from **UDP-glucose** to form **UDG-Galactose** (see **Figure 13.13**).

See also: [Galactose Metabolism](#),

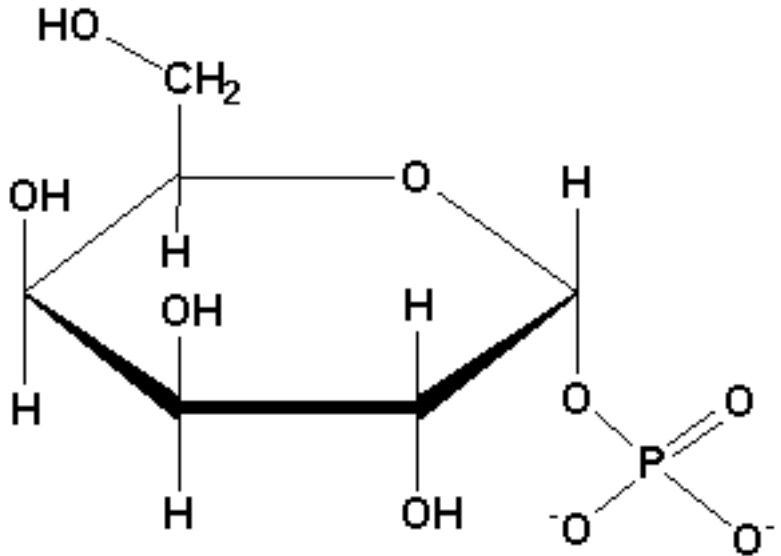

Galactose-1-phosphate

Galactokinase



Galactokinase catalyzes conversion of galactose to galactose-1-phosphate using ATP. The reaction is important in galactose metabolism.



See also: [Figure 13.13](#), [Galactose Metabolism](#)

Galactose Metabolism

The main route for **galactose** utilization is conversion to **glucose-6-phosphate**, as shown in **Figure 13.13**.

1. This pathway begins with the ATP-dependent conversion of **galactose** to **galactose-1-phosphate**, catalyzed by **galactokinase** (**Figure 13.13**, reaction 1).
2. Conversion to **UDG-galactose** (**Figure 13.13**, reaction 2), by a transferase reaction with a nucleotide-linked sugar (catalyzed by UDP-glucose: α -**D-galactose-1-phosphate uridylyltransferase**). In this reaction, galactose-1-phosphate is swapped for the **glucose-1-phosphate** on **UDP-glucose**.
3. The NAD⁺-linked enzyme **UDP-galactose 4-epimerase** can then convert UDP-galactose to UDP-Glucose (reaction 3)* .
Details of this epimerization reaction are shown in **Figure 13.14**.
4. The glucose-1-phosphate formed in reaction 2 is then converted to glucose-6-phosphate by **phosphoglucomutase** (reaction 4), an enzyme involved also in **glycogen biosynthesis**. Nucleoside diphosphate sugars such as UDP-glucose are widely used intermediates in polysaccharide biosynthesis.

*Note in **Figure 13.13**, reaction 3 that UDP-glucose is formed from glucose-1-phosphate and UTP by UDP-glucose pyrophosphorylase. This enzyme is named from its reverse reaction, involving cleavage of the phosphoric acid anhydride bond in UDP-glucose by addition across that bond of the elements of pyrophosphoric acid.

The enzymes shown in **Figure 13.13** participate in mammary gland in the synthesis of **lactose** in milk. **Lactose** is formed from UDP-galactose plus **glucose** by **lactose synthase**, in the presence of the protein α -**lactalbumin**. The endergonic synthesis of UDP-galactose in this tissue proceeds smoothly because of its high rate of conversion to **lactose**.

See also: **Galactose**, **cAMP Receptor Protein**

NADPH

NADPH is an electron carrier. The molecule exists in two forms that vary in whether or not they are carrying electrons. **NADPH** is the reduced form of the molecule (has electrons). **NADP⁺** is the oxidized form of the same molecule (lacks electrons). **NADPH** is produced in cells primarily by reactions in the pentose phosphate pathway. In plants, photosynthesis is another source of **NADPH**.

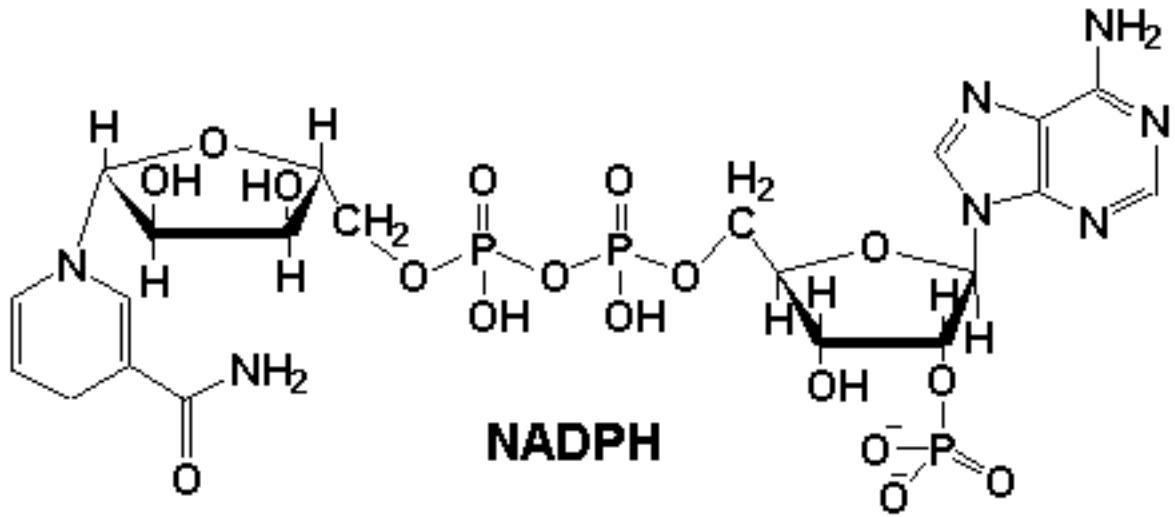

In contrast to the related compound, **NADH**, which donates electrons to the electron transport system for energy generation, **NADPH** donates electrons to biosynthetic reactions, such as the one below, catalyzed by ribonucleotide reductase:

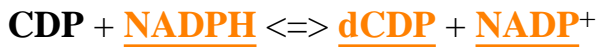

See also: [NADP⁺](#), [Photosynthesis](#), [Fatty Acid Synthesis](#), [Steroid Metabolism](#)

INTERNET LINK: [Nicotinate and Nicotinamide Metabolism](#)

NADP

NADPH is an electron carrier. The molecule exists in two forms that vary in whether or not they are carrying electrons. NADPH is the reduced form of the molecule (has electrons). **NADP⁺** is the oxidized form of the same molecule (lacks electrons). NADPH is produced in cells primarily by reactions in the **pentose phosphate pathway**. In plants, photosynthesis is another source of NADPH.

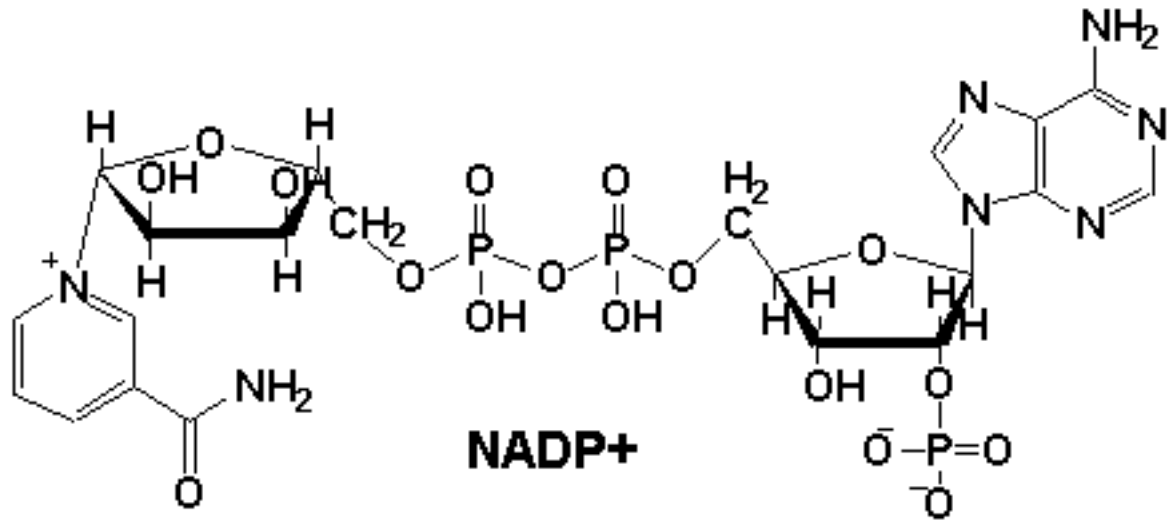

In contrast to the related compound, **NADH**, which donates electrons to the **electron transport** system for energy generation, **NADPH** donates electrons to biosynthetic reactions, such as the one below, catalyzed by **ribonucleotide reductase**:

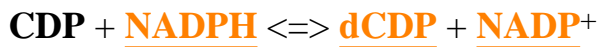

See also: [NADP⁺](#), [Photosynthesis](#), [Fatty Acid Synthesis](#), [Steroid Metabolism](#)

INTERNET LINK: [Nicotinate and Nicotinamide Metabolism](#)

Ribonucleotide Reductase

Ribonucleotide reductase is the enzyme that catalyzes synthesis of deoxyribonucleoside diphosphates (dNDPs) from ribonucleoside diphosphates (rNDPs). **Ribonucleotide reductase** reduces the hydroxyl at carbon 2 of the **ribose** sugar in the rNDP to a hydrogen, forming a **deoxyribose** sugar and a corresponding dNDP. A free-radical mechanism is involved in the reaction. Three classes of **ribonucleotide reductases** are known.

Class I Ribonucleotide Reductases - The most widely distributed form of **ribonucleotide reductase**. It acts upon ribonucleoside diphosphates. The enzyme generates a free radical on a **tyrosine** residue, with the aid of a diferric oxygen bridge.

Class II Ribonucleotide Reductases - Found in cyanobacteria, some bacteria, and *Euglena*. The enzyme acts on ribonucleoside triphosphate substrates. It uses adenosylcobalamin, a **B12** coenzyme to generate a free radical.

Class III Ribonucleotide Reductases - Found only in facultative or obligate anaerobes. The enzyme acts on ribonucleoside triphosphate substrates. It uses **S-adenosylmethionine** and an iron-sulfur center to generate the catalytically essential radical on a **glycine** residue.

The most common form of **ribonucleotide reductase** (Class I) is an $\alpha_2\beta_2$ dimer. The structure of the *E. coli* enzyme is shown in **Figure 22.13**. The two α subunits form the large subunit of the protein called R1. It contains the active site. The two β subunits make up the small subunit of the protein called R2, which contains the free radical. A clue to the mechanism of action of the enzyme (tyrosine free radical) is shown in **Figure 22.14**. **Hydroxyurea**, an inhibitor of **ribonucleotide reductase**, destroys the free radical.

A proposed mechanism of action of **ribonucleotide reductase** is shown in **Figure 22.15**. Reduction of the ribonucleotides requires electrons. These ultimately come from NADPH and are delivered to ribonucleotide reductase by either **thioredoxin** or **glutaredoxin**, as shown in **Figure 22.16**. Evidence exists for a possible third electron carrier in *E. coli*. Some of the interesting biological activities of thioredoxin are listed in **Table 22.1**.

See also: [Regulation of Ribonucleotide Reductase](#), [Ribonucleotide Reductase and Deoxyribonucleotide Biosynthesis](#)

INTERNET LINK: [Ribonucleotide Reductase R2 Structure](#)



D-Ribose

D-Ribose is a five carbon sugar contained in [ribonucleosides](#), [ribonucleotides](#), and their derivatives. (Note that D here refers to the D/L configuration, not "deoxy" as in [deoxyribose](#))

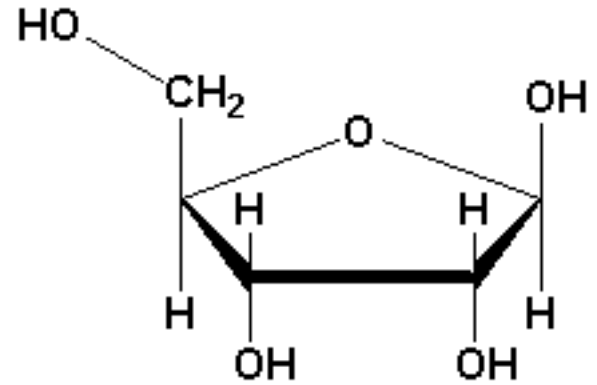

D-Ribose

See also: [RNA](#), [De Novo Biosynthesis of Purine Nucleotides](#), [De Novo Pyrimidine Nucleotide Metabolism](#)

Nucleosides

Deoxyribonucleosides or **ribonucleosides** are collectively called **nucleosides**. A **nucleoside** differs from a nucleotide in lacking a phosphate. **Nucleosides** are named according to the base they contain.

Nucleosides are composed of a base ([adenine](#), [guanine](#), [cytosine](#), [thymine](#), or [uracil](#)) attached to a sugar ([ribose](#) for ribonucleosides or [deoxyribose](#) for deoxyribonucleosides).

Corresponding to the bases above, common **ribonucleosides** are named [adenosine](#), [guanosine](#), [cytidine](#), and [uridine](#), respectively. Common **deoxyribonucleosides** are named [deoxyadenosine](#), [deoxyguanosine](#), [deoxycytidine](#), [deoxyuridine](#), and (deoxy)[thymidine](#), respectively.

See also: [Figure 4.3, Nucleotides](#)

Adenine

Adenine is a **purine** base found in **DNA** and **RNA**. In nucleosides and nucleotides, **adenine** is linked to the sugar moiety via a covalent bond between nitrogen #9 of **adenine** and carbon #1 of the sugar.

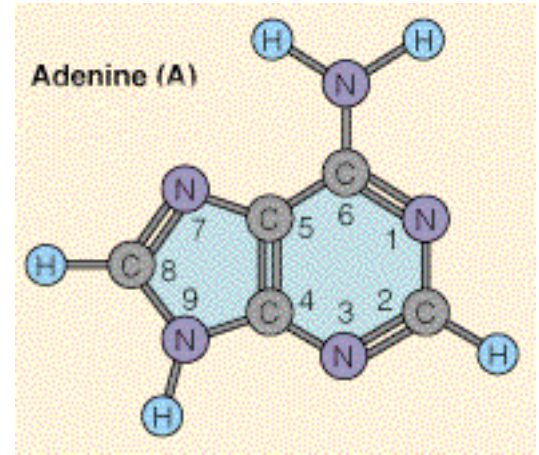

The ribonucleoside containing **adenine** is called **adenosine**. The deoxyribonucleoside containing **adenine** is called **deoxyadenosine**.

See also: [Figure 4.2](#), [Figure 4.3](#), [Nucleosides](#), [Nucleotides](#)

Purines

Purines are bases found in the nucleosides and nucleotides that make up nucleic acids. In nucleic acids, the **purines** match up with specific pyrimidine bases. The matching between purines and pyrimidines forms "base-pairs" in which **adenine** pairs with **thymine** (in DNA) or **uracil** (in RNA). **Guanine** pairs with the base **cytosine** in either nucleic acid.

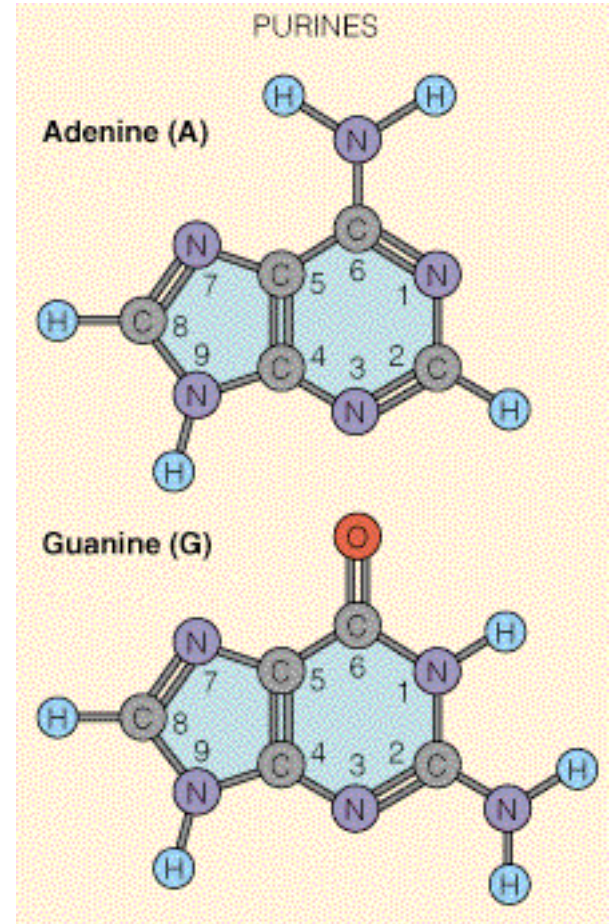

See also: [Pyrimidines](#), [DNA](#), [RNA](#), [Nucleosides](#), [Nucleotides](#), [6-Mercaptopurine](#), [Nucleic Acids](#)

INTERNET LINK - [Purine Metabolism](#)

Thymine

Thymine is a **pyrimidine** base found almost exclusively in **DNA**. In nucleosides and nucleotides, **thymine** is linked to the sugar moiety via a covalent bond between nitrogen #1 in **thymine** and carbon #1 of the sugar. The **deoxyribonucleoside** containing **thymine** is called **thymidine**.

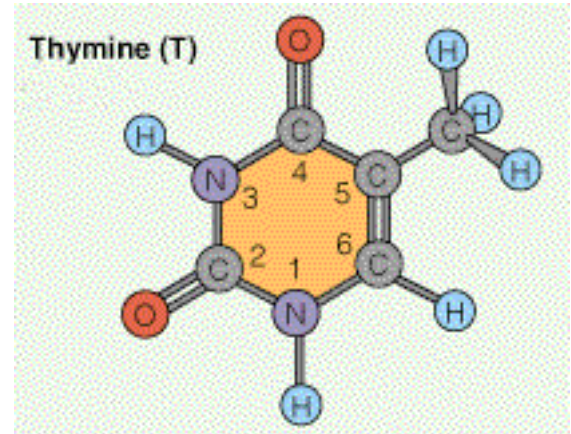

See also: [Figure 4.3](#), [Figure 4.2](#), [Nucleotides](#)

Pyrimidines

Pyrimidines are a class of bases found in nucleosides and nucleotides that make up nucleic acids. The **pyrimidines** cytosine and thymine are found in DNA, whereas cytosine and uracil are found in RNA.

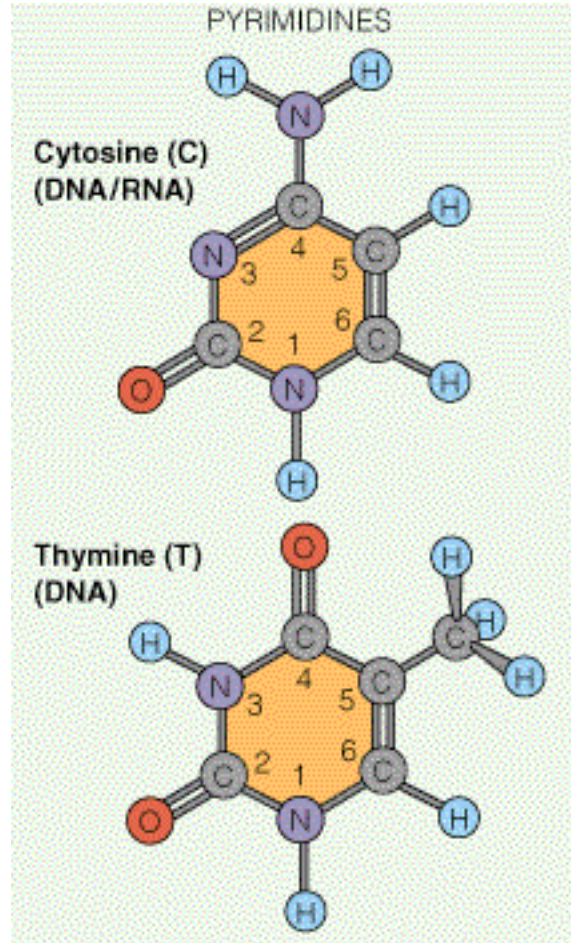

Uracil (U)
(RNA)

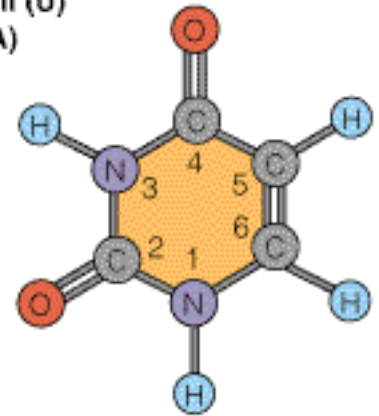

In nucleic acids, the **pyrimidines** match up with specific purine bases. The matching between purines and **pyrimidines** forms "base-pairs" in which **uracil** (in RNA) or **thymine** (in DNA) pairs with **adenine**. **Cytosine** pairs with the base **guanine** in either nucleic acid.

See also: [Purines](#), [DNA](#), [RNA](#), [Nucleosides](#), [Nucleotides](#), [Nucleic Acids](#)

Uracil

Uracil is a pyrimidine base found almost exclusively in **RNA**. In **nucleosides** and **nucleotides**, **uracil** is linked to the sugar moiety via a covalent bond between nitrogen 1 in **uracil** and carbon 1 of the sugar.

Uracil (U)

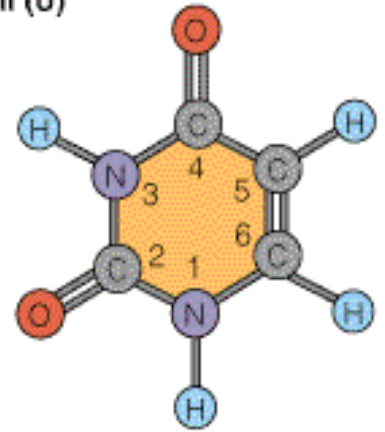

The ribonucleoside containing **uracil** is called **uridine**. The deoxyribonucleoside containing **uracil** is called **deoxyuridine**.

See also: [Figure 4.3](#), [Figure 4.2](#), , [De Novo Pyrimidine Nucleotide Metabolism](#), [Deoxyuridine Nucleotide Metabolism](#), [Nucleotide Salvage Synthesis](#)

Guanine

Guanine is a **purine** base found in **DNA** and **RNA**. In **nucleosides** and **nucleotides**, **guanine** is linked to the sugar moiety via a covalent bond between nitrogen #9 of **guanine** and carbon #1 of the sugar.

The ribonucleoside containing **guanine** is called **guanosine**.
The deoxyribonucleoside containing **guanine** is called **deoxyguanosine**.

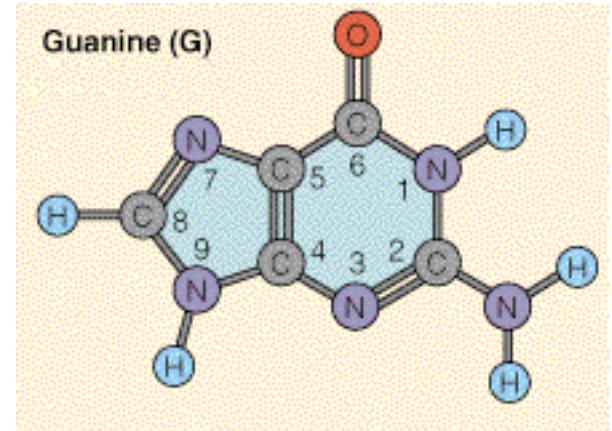

See also: [Figure 4.3](#), [Figure 4.2](#)

Guanosine

Guanosine is a **nucleoside** containing **guanine**. **Guanosine** differs from guanine in containing a sugar (**ribose**). Phosphorylation of **guanosine** produces a **nucleotide** found in **RNA**.

Deoxyguanosine is a related nucleoside that contains **deoxyribose** instead of ribose as the sugar.

See also: [Figure 4.3](#), [DNA](#), [Acyclovir](#), [Ganciclovir](#), [De Novo Biosynthesis of Purine Nucleotides](#)

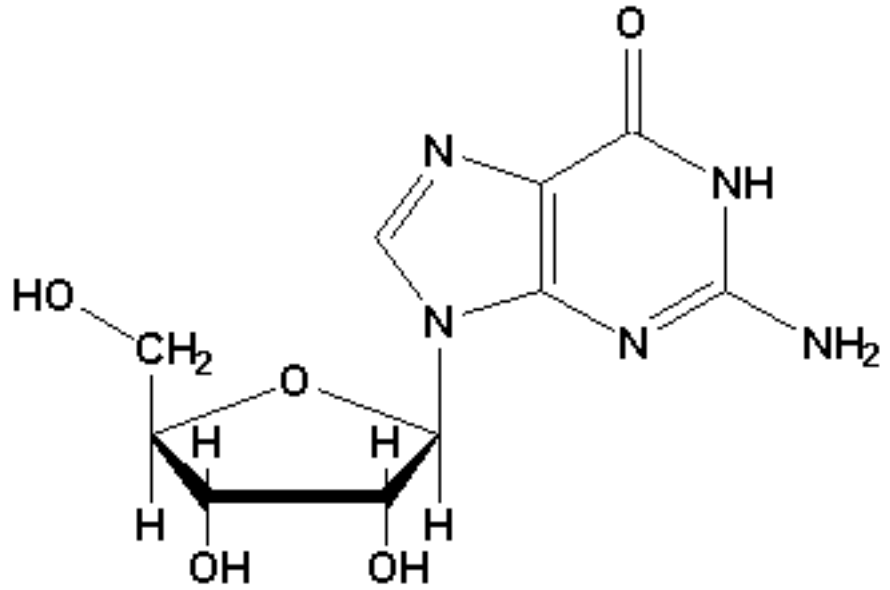

Guanosine

Deoxyribose

Deoxyribose (more accurately named **2-deoxyribose**) is a five carbon sugar contained in [deoxyribonucleosides](#), [deoxyribonucleotides](#), and their derivatives. **Deoxyribose** differs from [ribose](#) in lacking a hydroxyl at position 2. Deoxyribonucleotides are the monomeric units (building blocks) of [DNA](#).

See also: [Ribonucleotide Reductase and Deoxyribonucleotide Biosynthesis](#)

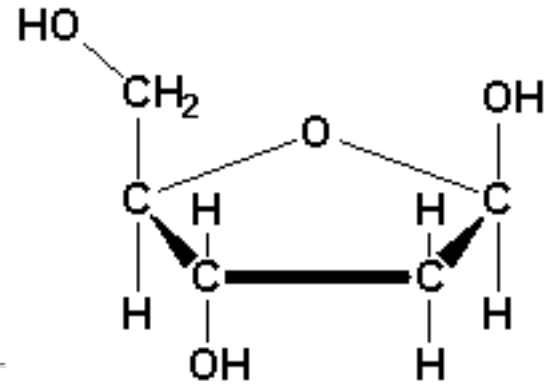

Deoxyribose

Ribonucleotide Reductase and Deoxyribonucleotide Biosynthesis

Most of the carbon that flows through nucleotide synthetic pathways goes into ribonucleotide triphosphates (rNTPs - [ATP](#), [CTP](#), [GTP](#), and [UTP](#)). A relatively small fraction is diverted to the synthesis of deoxyribonucleoside triphosphates (dNTPs). rNTPs are synthesized in excess of dNTPs because most cells contain 5-10 times as much RNA as DNA and because rNTPs have multiple metabolic roles, whereas dNTPs are used only to make DNA.

As seen in [Figure 22.12](#), rNDPs ("D" here refers to di-) are all converted to dNDPs by the enzyme ribonucleoside diphosphate reductase (also called ribonucleotide reductase, rNDP reductase, or RNR). The relatively simple routes giving rise to [dATP](#), [dGTP](#), and [dCTP](#), are in contrast to the involved mechanism for [dTTP](#). Note that [dUDP](#) is a precursor of [dTTP](#).

[Ribonucleotide reductase](#), the enzyme catalyzing the synthesis of dNDPs from rNDPs, reduces the hydroxyl at carbon 2 to a hydrogen via a free radical mechanism. The following three classes of **ribonucleotide reductases** are known:

Class I ribonucleotide reductases - The most widely distributed form of ribonucleotide reductase. Class I enzyme acts upon ribonucleoside diphosphates. The enzyme generates a free radical on a [tyrosine](#) residue with the aid of a diferric oxygen bridge.

Class II ribonucleotide reductases - Found in cyanobacteria, some bacteria, and *Euglena*, the Class II enzyme acts on ribonucleoside triphosphate substrates. It uses adenosylcobalamin, a [B12](#) coenzyme to generate a free radical.

Class III ribonucleotide reductases - Found only in facultative or obligate anaerobes, the Class III enzyme acts on ribonucleoside triphosphate substrates. It uses [S-adenosylmethionine](#) and an iron-sulfur center to generate the catalytically essential radical on a [glycine](#) residue.

The most common form of the enzyme (Class I) is an $\alpha_2\beta_2$ dimer. The structure of the *E. coli* enzyme is shown in [Figure 22.13](#). The two α subunits form the large subunit of the protein called R1. It contains the active site. The two β subunits make up the small subunit of the protein called R2, which contains the free radical. A clue to the mechanism of action of the enzyme (tyrosine free radical) is shown in [Figure 22.14](#). [Hydroxyurea](#), an inhibitor of ribonucleotide reductase, destroys the free radical.

A proposed mechanism of action for **ribonucleotide reductase** is shown in [Figure 22.15](#). Reduction of the ribonucleotides requires electrons. These ultimately come from [NADPH](#) and are delivered to **ribonucleotide reductase** by either [thioredoxin](#) or [glutaredoxin](#), as shown in [Figure 22.16](#). Evidence

exists for a possible third electron carrier in *E. coli*. Some of the interesting biological activities of thioredoxin are listed in [Table 22.1](#).

See also: [Regulation of Ribonucleotide Reductase](#)

INTERNET LINK: [Ribonucleotide Reductase R2 Structure](#)

Cytidine Triphosphate (CTP)

CTP is a ribonucleotide used in synthesis of several compounds, including **RNA**, and several glycerophospholipids. It allosterically inhibits the enzymes **aspartate transcarbamoylase**, and CTP synthetase (see below), which are both involved in nucleotide metabolism.

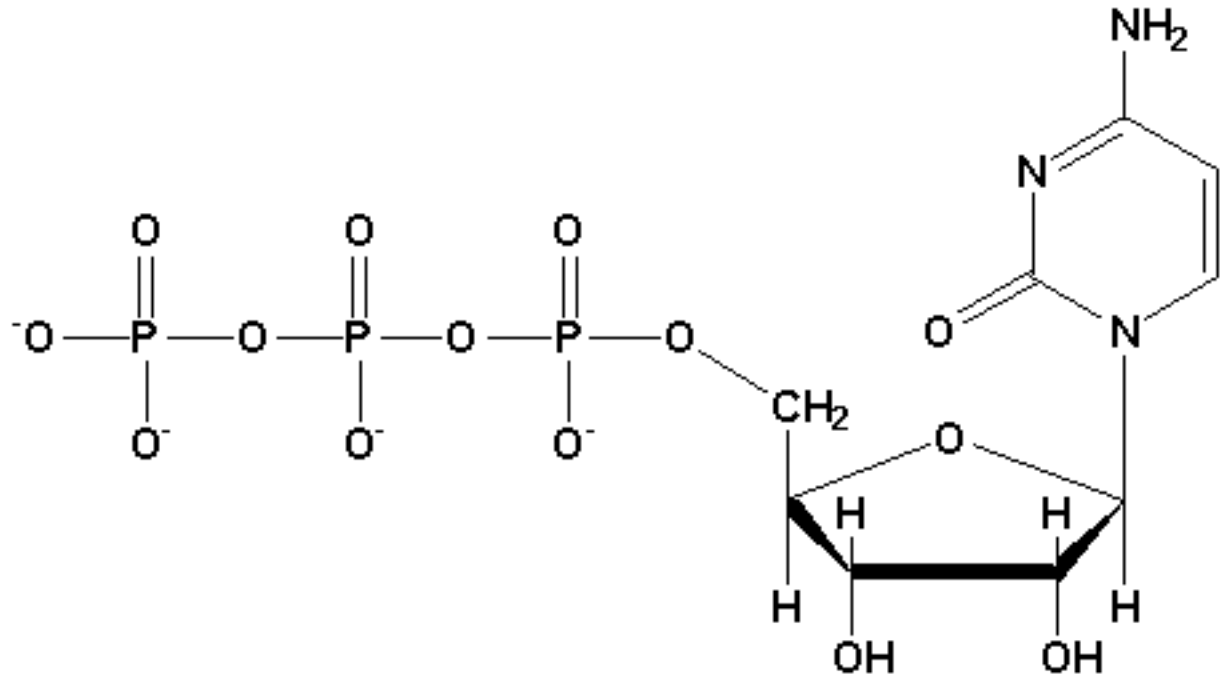

Cytidine Triphosphate (CTP)

1. **Phosphocholine** + **CTP** \rightleftharpoons **CDP-choline** + P_{Pi}, (catalyzed by CTP:phosphocholine cytidyl transferase)
2. **Phosphatidic Acid** + **CTP** \rightleftharpoons **CDP-Diacylglycerol** + P_{Pi}
3. **CDP** + **ATP** \rightleftharpoons **CTP** + **ADP** (catalyzed by **Nucleoside Diphosphokinase**)
4. **UTP** + **ATP** + **Gln** \rightleftharpoons **CTP** + **ADP** + **Glu** + Pi (catalyzed by **CTP Synthetase**)

CTP is an allosteric inhibitor of **glutamine synthetase**, an enzyme with a central role in nitrogen metabolism in the cell.

See also: **Cytosine**, **RNA**

Aspartate Carbamoyltransferase

Aspartate carbamoyltransferase (also known as **aspartate transcarbamoylase** or **ATCase**) is one of the most studied enzymes for allosteric regulation. It catalyzes the reaction that follows:



As seen in [Figure 11.35](#), **ATCase** is at the crossroads of biosynthetic pathways that lead to proteins or pyrimidines. **ATCase** catalyzes the joining of aspartate and carbamoyl phosphate to form N-carbamoyl-L-aspartate, the first metabolite committed to the synthesis of pyrimidines. The enzyme is sensitive to feedback inhibition by cytidine triphosphate (**CTP**), one of the end products of the pathway, and is activated by **ATP**, a purine nucleotide ([Figure 11.36](#)). **ATCase** is a multisubunit protein consisting of 6 catalytic subunits and 6 regulatory subunits. The quaternary structure of **ATCase** enzyme is shown in [Figure 11.37](#). A detailed representation of one catalytic subunit and one regulatory subunit is shown in [Figure 11.38](#).

Allosteric regulation of **ATCase** involves changes in the quaternary structure of the molecule. A major rearrangement of subunit positions occurs in the T-> R transition.

Sometimes different organisms regulate similar pathways in different ways. For example, **ATCase** is the major control point in the pyrimidine pathway synthesis in bacteria, whereas eukaryotes regulate the synthesis of carbamoyl phosphate ([Figure 11.35](#)). In mammals, the [carbamoyl phosphate synthetase II](#) is inhibited by **UDP**, **UTP**, **CTP**, **dUDP**, and **UDP-glucose**.

See also: [Regulation of Enzyme Activity](#), [Pyrimidine Nucleotide Metabolism](#) (from Chapter 22), [Figure 22.10](#)

INTERNET LINKS:

1. [Properties of Allosteric Enzymes](#)
 2. [Image of ATCase](#) (slow)
-

Aspartic Acid (Aspartate)

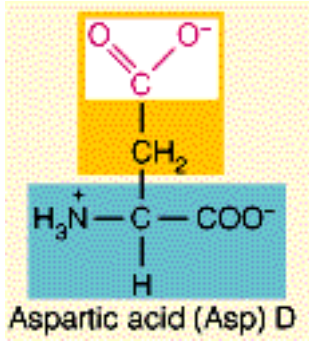

Aspartic acid (aspartate) is an α **amino acid** found in **proteins**. In mammals, **aspartic acid** is a non-essential amino acid, meaning it does not need to be present in the diet. **Aspartic acid** (surprise!) is classified as an acidic amino acid.

Aspartate is involved in the control point of pyrimidine biosynthesis (Reaction 1 below), in transamination reactions (Reaction 2 below), interconversions with asparagine (reactions 3 and 4), in the metabolic pathway leading to AMP (reaction 5 below), in the urea cycle (reactions 2 and 8 below), IMP *de novo* biosynthesis, and is a precursor to **homoserine**, **threonine**, **isoleucine**, and **methionine** (reaction 7 below). It is also involved in the **malate aspartate shuttle**.

One Letter Code	Three Letter Code	Molecular Wt. (Daltons)	Genetic Code Codons
D	ASP	115.09	GAU, GAC

Reactions involving Aspartic Acid

1. **Aspartate** + **Carbamoyl Phosphate** \rightleftharpoons **Carbamoyl Aspartate** (catalyzed by **Aspartate Transcarbamoylase**)
2. **Oxaloacetate** + **Glutamate** \rightleftharpoons **Aspartate** + α -**Ketoglutarate** (catalyzed by **Aminotransferase**)
3. **Aspartic Acid** + **ATP** + NH₃ (**Gln**) \rightleftharpoons **Asparagine** + **AMP** + PPi + **Glutamate** (catalyzed by **Asparagine Synthetase** - the enzyme strongly prefers to use the amine group of glutamine over that of free ammonia)
4. **Glutamine** + H₂O \rightleftharpoons **Aspartic Acid** + NH₃ (catalyzed by Asparaginase)
5. **IMP** + **Aspartic Acid** + **GTP** \rightleftharpoons **Adenylosuccinate** + **GDP** + Pi (catalyzed by **Adenylosuccinate Synthetase**)

6. CAIR + **Aspartate** + ATP \rightleftharpoons SACAIR + ADP + Pi (catalyzed by SACAIR Synthetase)

7. **Aspartate** + **ATP** \rightleftharpoons β -**Aspartyl-Phosphate** + **ADP** (catalyzed by **Aspartokinase**)

8. **Citrulline** + **Aspartate** + ATP \rightleftharpoons **Argininosuccinate** + AMP + PPi (catalyzed by **Argininosuccinate Synthetase**).

See also: [Table 5.1](#), [Genetic Code](#), [Asparagine](#), [Citrulline](#), [Urea Cycle](#), [Transamination in Amino Acid Metabolism](#), [Citric Acid Cycle Intermediates in Amino Acid Metabolism](#), [Essential Amino Acids](#)

INTERNET LINKS:

1. [Alanine Aspartate Metabolism](#)
 2. [Urea Cycle and Metabolism of Amino Groups](#)
-

L-Homoserine

L-Homoserine is found in many tissues as an intermediate in amino acid metabolism, including [threonine](#), [isoleucine](#), and [methionine](#). Catabolism of aspartate to **homoserine** is shown [here](#). The biosynthetic pathway from **homoserine** to methionine is shown in [Figure 21.6](#).

[Aspartic \$\beta\$ Semialdehyde](#) + [NADPH](#) + H⁺ \rightleftharpoons
Homoserine + [NADP](#)⁺ (catalyzed by homoserine dehydrogenase).

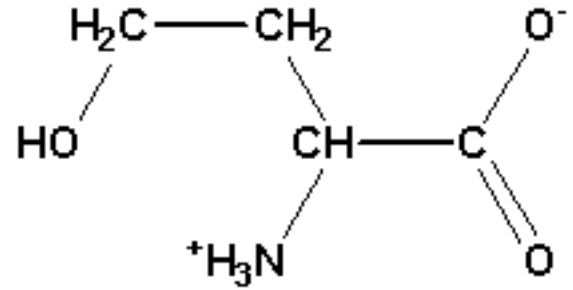

Homoserine

See also: [Amino Acids Not In Proteins](#), [Metabolism of Serine, Glycine, and Threonine](#), [Metabolism of Valine, Leucine, Isoleucine, and Lysine](#), [Metabolism of Sulfur-Containing Amino Acids](#)

INTERNET LINK: [Gly, Ser, Thr Metabolism](#)

Threonine

Threonine is an α **amino acid** found in proteins. In mammals, **threonine** is an essential amino acid, meaning it must be present in the diet.

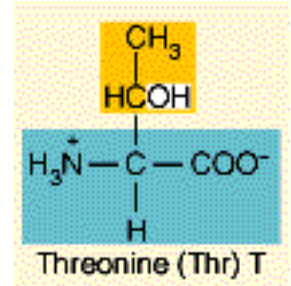

The hydroxy- and sulfur-containing amino acids are generally more hydrophilic than their aliphatic analogs.

Threonine's alcohol side group is a target for phosphorylation in proteins.

<

One Letter Code	Three Letter Code	Molecular Wt. (Daltons)	Genetic Code Codons
T	THR	101.11	ACU, ACC, ACA, ACG

See also: [Table 5.1](#), , [Genetic Code](#), [Metabolism of Serine, Glycine, and Threonine](#), [Essential Amino Acids](#)

INTERNET LINK: [Gly, Ser, Thr Metabolism](#)

Metabolism of Serine, Glycine, and Threonine

Serine - **Serine** has many important biological roles, including the biosynthesis of phospholipids and **cysteine**. Serine also contributes activated one-carbon units to the pool of **tetrahydrofolate coenzymes**. **Serine** can be made in a variety of ways, including the way shown **here** and **Figure 21.24**. **Serine** is catabolized by conversion to **glycine** or by action of **serine-threonine dehydratase** (**Figure 21.25**).

Glycine - **Glycine** also contributes to the one-carbon pool, to formation of **glutathione**, to purine nucleotides (see **here**), and to porphyrins (**Figure 21.24**). **Glycine** can be made as a cleavage product of **threonine** by **threonine aldolase** (see **here**). **Glycine** is catabolized via the mitochondrial **glycine** cleavage system to yield NH₃, CO₂, and **5,10-methylenetetrahydrofolate**.

Threonine - **Threonine** is an essential amino acid in animals. Its synthesis is confined to plants and prokaryotes. **Threonine** can be cleaved by **threonine aldolase** to yield glycine and acetaldehyde (see **here**). Threonine is also acted on by **serine-threonine dehydratase** (**Figure 21.25**).

See also: **Metabolism of Valine, Leucine, Isoleucine, and Lysine**, **Essential Amino Acids**

INTERNET LINK: Gly, Ser, Thr Metabolism

Cysteine

Cysteine is an α amino acid found in proteins. In mammals, **cysteine** is a non-essential amino acid, meaning it does not need to be present in the diet.

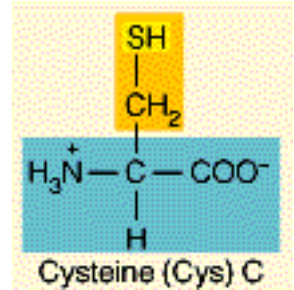

The hydroxy and sulfur-containing amino acids are generally more hydrophilic than their aliphatic analogs, although methionine is fairly hydrophobic. **Cysteine** can ionize at high pH (see [here](#)) **Cysteine**, together with another **cysteine** in a protein, can form disulfide bonds (see [here](#)). Disulfide bonds help to stabilize the structure of some proteins.

Some proteins interconvert between disulfides and thiols. **Glutathione** provides a major protective mechanism against oxidative stress. For example, it helps keep **cysteine** thiol groups in proteins in the reduced state (see [here](#)). If two thiol groups become oxidized, they can be reduced nonenzymatically by glutathione.

One Letter Code	Three Letter Code	Molecular Wt. (Daltons)	Genetic Code Codons
C	CYS	103.14	UGU, UGC

See also: [Table 5.1, Amino Acids, Genetic Code, Methionine, , Metabolism of Sulfur-Containing Amino Acids, Essential Amino Acids](#)

INTERNET LINK: [Cysteine Metabolism](#)

Unnumbered Item

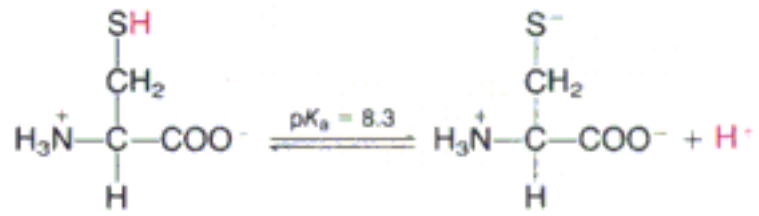

Unnumbered Item

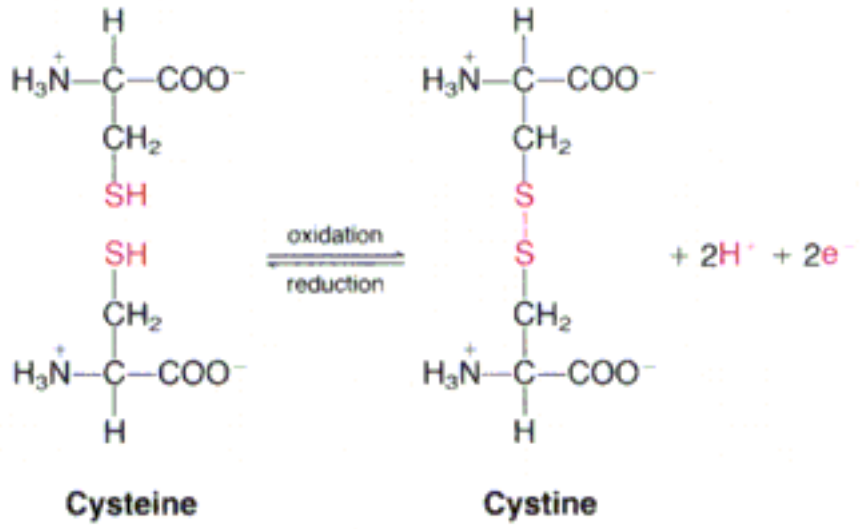

Glutathione

Glutathione is a tripeptide containing the amino acids [glutamate](#), [cysteine](#), and [glycine](#), linked together in that order (see [here](#)). The glutamate is linked to the cysteine via the γ -carboxyl group.

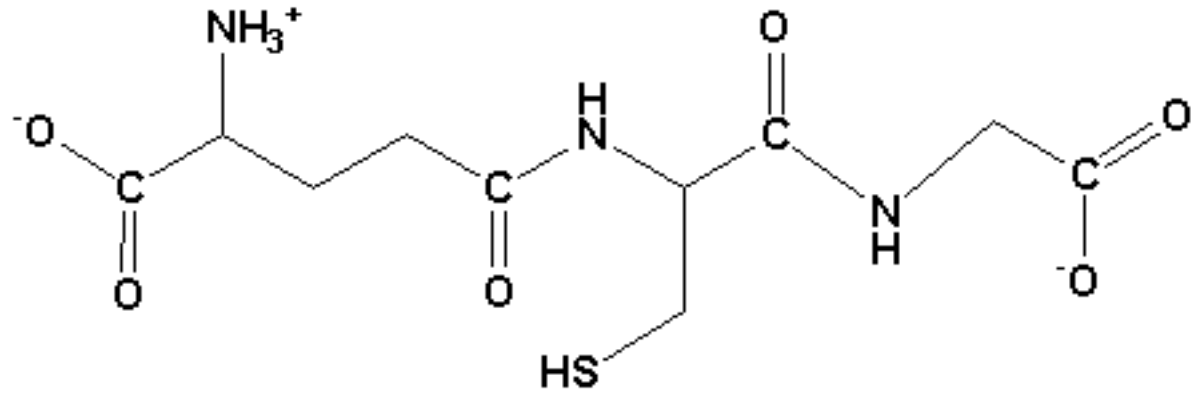

Glutathione

Glutathione's free thiol group provides protection for cells against oxidative stress. For example, it can help to keep cysteine thiol groups in proteins in the reduced state. If two thiol groups become oxidized, they can be reduced nonenzymatically by **glutathione**.

See also: [Cysteine](#), [Glutamic Acid](#), [Glycine](#), [Glutathione Peroxidase](#), [Metabolism of Glutathione](#), [Glutaredoxin](#), [Glutathione Reductase](#), [Figure 22.16](#)

INTERNET LINK: [Glutathione Metabolism](#)

Unnumbered Item

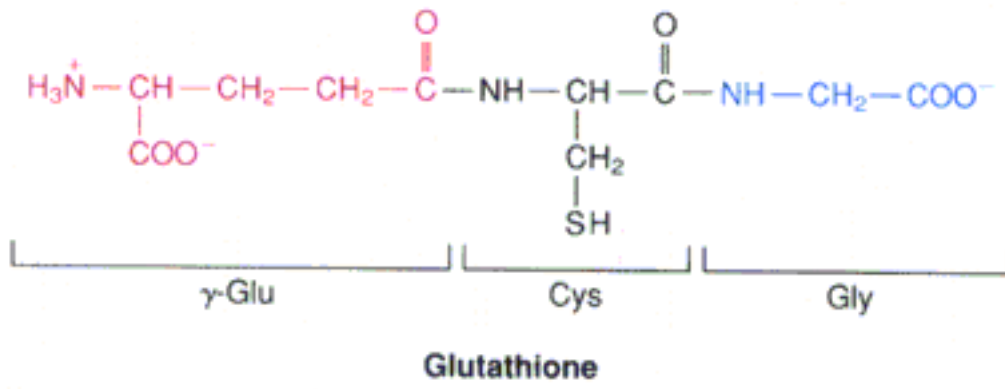

Glutathione Peroxidase

Glutathione peroxidase catalyzes the reaction:

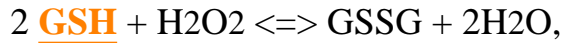

where GSH refers to reduced glutathione and GSSG is the oxidized form of glutathione in which two molecules are joined by sulfhydryl bonds.

Glutathione peroxidase thus protects against oxidative damage by reducing the reactive oxygen species, H₂O₂ to water. The enzyme is interesting in that it contains the rare amino acid, [selenocysteine](#).

See also: [Antioxidants](#), [Reactive Oxygen](#), [Oxygen Metabolism and Human Disease](#), , [Glutathione](#)

INTERNET LINK: [Glutathione Metabolism](#)

Selenocysteine

Selenocysteine is a rare amino acid that is incorporated into a few proteins using the codon UGA. Normally UGA is **stop codon**, but the proteins that use UGA for **selenocysteine** usually have **mRNA** with significant secondary structure around the UGA. This may cause the **ribosome** to not recognize the UGA as a stop codon, allowing the **selenocysteinyl-tRNA** to incorporate the amino acid at that point.

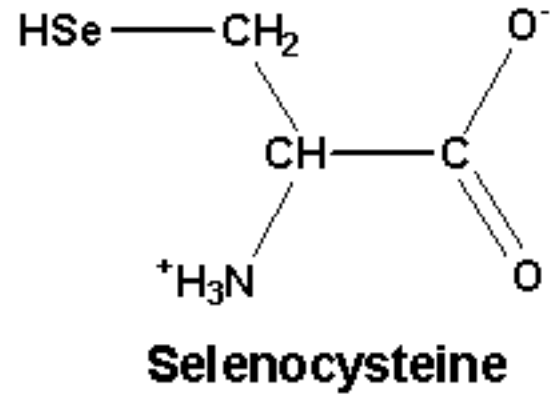

See also: [Amino Acids](#), [Glutathione Peroxidase](#), [Genetic Code](#)

Stop Codons

Stop codons are the "punctuation marks" of the [genetic code](#) that cause a [ribosome](#) to stop making [protein](#) when they are encountered in the process of [translation](#). Though there are rare variations in the sequence of [nucleotides](#) making up **stop codons**, the **stop codons** for almost all organisms are UAA, UAG, and UGA.

See also: [mRNA](#), [Translation Overview](#)

Translation Overview

The **genetic code** specifies unique three base sequences (called **codons**) for each of the 20 amino acid residues. Transfer RNA molecules (**tRNAs**), which are composed of a nucleic acid and a specific amino acid, provide the link between the nucleic acid sequence of messenger RNA (**mRNA**) and the amino acid sequence it codes for.

Each tRNA molecule for a particular amino acid contains a three nucleotide sequence, called an **anticodon**, which is complementary to the codon for that amino acid.

A specific enzyme called an **aminoacyl-tRNA synthetase**, catalyzes the attachment between each tRNA and its corresponding amino acid.

The information to be translated is carried from the cell nucleus to the cytosol by messenger RNA (mRNA). The base sequence in mRNA, in turn, is a complementary copy of the cell's DNA base sequence. For a discussion of transcription, see [here](#).

Translation, therefore, is the conversion of the information in the nucleic acid sequence to polypeptides of a specific amino acid sequence. The process of **translation** requires a system to bring the mRNA together with the translating molecules (tRNAs). The system must also catalyze the polymerization of the amino acids into a polypeptide sequence.

The message in mRNAs is the sequence of nucleotide bases and is always read in the 5' to 3' direction. The polypeptide chain is made starting with the amino end of the chain first and carboxyl end of the chain last. Thus, the 5' end of the coding region of the mRNA contains the code for the amino end of the polypeptide chain.

See also: [Structure of Prokaryotic mRNAs](#), [Structure of tRNAs](#), [Ribosomes](#), [Initiation of Translation](#), [Elongation of Translation](#), [Termination of Translation](#)

INTERNET LINKS:

1. [Transcription/Translation Summary](#)
 2. [tRNA Synthetase Image](#)
-

The Genetic Code

The **genetic code** ([Figure 27.3](#)) is specified in discrete units of three nucleotides called **codons**. One codon precisely follows another. The simple, unpunctuated code is found throughout all known prokaryotic cells. Genes in eukaryotic cells are a bit more complex. Some primitive eukaryotic genes have single codon overlaps that are removed by a process called editing (see [here](#)). Other eukaryotic genes have sequences in immature RNA that are removed by a process called **splicing**. Nonetheless, at the time of translation, all editing and splicing is complete, so that the translated code is completely unpunctuated, as shown in [Figure 27.1](#).

The **genetic code** (also called "the code") is almost, but not quite, universal. That is, it is almost, but not quite, the same in prokaryotes, eukaryotes and viruses. The rare exceptions are known of only in mitochondria and a few protozoans. One alternate coding sequence is the UGA codon, which in the universal genetic code is a STOP codon (i.e., it stops translation, see below), but in many organisms can occasionally specify the rare amino acid, **selenocysteine** ([Table 27.1](#)).

In general, each amino acid is specified by the first two bases of a codon. For example, all four proline codons begin with CC and all four valine codons begin with BU. Thus, redundancy in the **genetic code** is usually expressed in the third letter. Furthermore, a single tRNA may recognize several different codons for the same amino acid. For this reason, the third base is referred to as the "wobble" position, because it exhibits looser rules for pairing with the anticodon of the tRNA ([Table 27.2](#), [Figure 27.4](#)). Part of the wobble can be explained by the presence of the uncommon nucleoside, inosine ([Figure 22.4](#)), which is found in a number of anticodons and can pair with A, U, or C.

The **mRNA** is almost always longer than the message that is to be translated. Thus, specific start and stop signals are needed to start and stop translation.

The codons UAA, UAG, and UGA are called STOP codons because they cause the ribosome to stop translation when it encounters one of them (in almost all cases).

The sequence AUG, which specifies the amino acid **methionine**, is commonly used to define a translational starting point, but AUG is also found in the middle of coding sequences. Thus the translational starting point must have other sequences that help to define where to begin. In addition, prokaryotic organisms use a modified form of methionine (N-formylmethionine) to start translation. Eukaryotic cells simply use methionine. Once translation has begun, AUG is read simply as methionine in the internal part of a gene in all organisms. Rare start codons include GUG, UUG, and AUU, which also code for valine, leucine, and isoleucine, respectively. When they are used as the first codon, however, N-formylmethionine is still incorporated as the first amino acid.

See also: [Structure of Prokaryotic mRNAs](#), [Translation Overview](#), [Structure of tRNAs](#), [Genetic Code](#) (from Chapter 5)

INTERNET LINK: [Reading the Message in Genes](#)

Figure 27.3: The genetic code (as written in RNA).

		Second position					
		U	C	A	G		
First position (5' end)	U	UUU } Phe UUC } UUA } Leu UUG }	UCU } UCC } Ser UCA } UCG }	UAU } Tyr UAC } UAA } Stop UAG } Stop	UGU } Cys UGC } UGA } Stop UGG } Trp	U	C
	C	CUU } CUC } Leu CUA } CUG }	CCU } CCC } Pro CCA } CCG }	CAU } His CAC } CAA } Gln CAG }	CGU } CGC } Arg CGA } CGG }	U	C
	A	AUU } AUC } Ile AUA } AUG } Met	ACU } ACC } Thr ACA } ACG }	AAU } Asn AAC } AAA } Lys AAG }	AGU } Ser AGC } AGA } Arg AGG }	U	C
	G	GUU } GUC } Val GUA } GUG }	GCU } GCC } Ala GCA } GCG }	GAU } Asp GAC } GAA } Glu GAG }	GGU } GGC } Gly GGA } GGG }	U	C
						A	G
						Third position (3' end)	

Processing of mRNA

There are significant differences in the ways that messenger RNAs (**mRNAs**) for protein-coding genes are produced and processed in prokaryotic and eukaryotic cells.

Prokaryotes - Prokaryotic mRNAs are synthesized on the bacterial nucleoid in direct contact with the cytosol and are immediately available for translation. The Shine-Dalgarno sequence (see [here](#)) near the 5' end of the mRNA binds to a site on the prokaryotic ribosomal RNA (**rRNA**), allowing attachment of the **ribosome** and **initiation of translation**, often even before **transcription** is completed.

Eukaryotes - In eukaryotes, the mRNA is produced in the nucleus and must be exported into the cytosol for translation. Furthermore, the initial product of transcription (pre-mRNA) may include introns, which must be removed before translation can occur. There is no ribosomal attachment sequence like the Shine - Dalgarno sequence in prokaryotes. For all these reasons, eukaryotic mRNA requires extensive processing before it can be used as a protein template. This processing takes place while mRNA is still in the nucleus.

Capping - The first modification occurs at the 5' end of the pre-mRNA. A GTP residue is added in reverse orientation and forms, together with the first two nucleotides of the chain, a structure known as a cap ([Figure 28.30](#)). The cap is "decorated" by the addition of methyl groups to the N-7 position of the **guanine** and to one or two sugar hydroxyl groups of the cap nucleotides. The cap structure serves to position the mRNA on the ribosome for **translation**.

Splicing - After being capped, the pre-mRNA becomes complexed with a number of small nuclear ribonucleoprotein particles (**snRNPs**), which are themselves complexes of small nuclear RNAs (**snRNAs**) and special splicing enzymes. The snRNP--pre--mRNA complex is called a **spliceosome**. snRNAs recognize and bind **intron**--exon splice sites by means of complementary sequences ([Figure 28.31](#)). [Table 28.6](#) shows some representative splice site sequences and the consensus sequences common to most introns. Excision of a single intron involves assembling and disassembling a spliceosome. [Figure 28.32](#) and [Figure 28.33](#) depict possible chemical and molecular aspects of the process.

The sequence of reactions can be summarized as follows:

1. It begins with the attachment of the U1 snRNP to the G site at the 5' end of the intron.
2. The U2 snRNP then attaches at the branch site.
3. Assembly of the spliceosome continues, including the addition of several

more snRNPs,

4. The lariat loop in the intron is formed and the two exons are joined. Splicing has now been accomplished, and the products--a ligated mRNA and a looped intron--are released. As the spliceosome disintegrates, the looped intron is degraded, and the mRNA is exported from the nucleus.

Alternative Splicing - Some gene transcripts may be spliced in different ways, in different tissues of an organism or at different developmental stages. **Alternative splicing** of the heavy chains of immunoglobulins (see [here](#)) results in proteins that may or may not carry a hydrophobic membrane-binding domain. Another example of alternative splicing is shown in [Figure 28.34](#). The protein α -tropomyosin is used in different kinds of contractile systems in various cell types (see [here](#)). A single gene is transcribed, but the specific splicing patterns in different tissues provide a variety of α -tropomyosins. There are three positions at which alternative choices can be made for which exon to splice in. The choice of splice site appears to be determined by a cell-specific protein that interacts with the spliceosome. The economy of **alternative splicing**, given the size of the genome is significant.

RNA editing - **RNA editing** is a process affecting mitochondrial mRNAs of some unicellular eukaryotes, which involves insertion or deletion of uridine residues into messages during the processing steps. Apparently, the insertions are made by a kind of reverse splicing mechanism, and only at certain points. Small RNAs, called guide RNAs, are required for the process. A quite different type of editing involves deamination of [adenosine](#) to [inosine](#) in mRNA. Neither alternative splicing nor editing formally contradicts the basic concept that gene sequence carries the cell's information, because the sites for splicing and editing are themselves contained in the DNA, as are the sequences of the small nuclear RNAs and the guide RNAs.

After capping, poly(A) tailing, and splicing are complete, the newly formed mRNA is exported from the nucleus, almost certainly through the nuclear pores. It is then attached to ribosomes for translation.

See also: [Introns](#), [Termination of Eukaryotic Transcription](#), [Eukaryotic vs Prokaryotic Translation](#)

INTERNET LINKS:

1. [Small RNA Database](#)

2. [The RNA World](#)

3. [RNA Editing](#)

4. [RNA Modification Database](#)

5. ['U' Insertion/Deletion Database](#)

6. [Spliceosome](#)

7. [Splice Sites](#)

Structure of Prokaryotic mRNAs

Messenger RNA molecules (mRNAs) are single-stranded RNAs carrying the message that is to be translated into protein. In prokaryotic cells, messages for several proteins may be carried on a single **mRNA** (called polycistronic messages). Polycistronic messages arise because prokaryotic genes are organized into operons (see [here](#)). [Figure 27.5](#) depicts the *lac* operon from *E. coli*. Each of the messages for a single protein on the **mRNA** is contained in a single "open reading frame". In this case, the open reading frames correspond to the *lac z*, *y*, and *a* genes.

An open reading frame is a region of the nucleic acid sequence uninterrupted by start or stop codons. In polycistronic prokaryotic **mRNA**, the open reading frames are bounded by start and stop codons.

Just before the AUG start codon, prokaryotic **mRNAs** have a common sequence called the Shine-Dalgarno sequence. Some variations on the sequence are shown in [Table 27.3](#). The Shine-Dalgarno sequences are complementary to a sequence contained in the 16S ribosomal RNA (**rRNA**) ([Table 27.3](#)) and help align the **mRNA** with the [ribosome](#) to properly orient the molecules for translation initiation.

Some mRNA molecules are able to base-pair within themselves due to intramolecular complementarity and because **mRNA** molecules are single-stranded. As a result, some **mRNA** molecules can form the three-dimensional secondary and tertiary structures, which can play a role in regulation of the relative productions of various protein products.

See also: [The Genetic Code](#), [Structure of tRNAs](#), [Initiation of Translation](#), [Prokaryotic Translation Regulation](#), [Lactose Operon Regulation](#) (from Chapter 26), [Promoter Organization](#) (from Chapter 26)

Lactose Operon Regulation

Bacteria respond rapidly to changes in their environment. Genes for lactose utilization are activated once *E. coli* cells sense the presence of lactose or a similar compound

Operon composition/induction - The **lactose operon** consists of three linked structural genes that encode enzymes of lactose utilization, plus adjacent regulatory sites. The three structural genes--*z*, *y*, and *a*--encode β -galactosidase, β -galactoside permease (a transport protein), and thiogalactoside transacetylase (an enzyme of still unknown metabolic function), respectively.

In the presence of an inducer, all three enzymes accumulate simultaneously, but to different levels. **Lactose** itself leads to induction of the **lactose operon** (also called the **lac operon**), but the true intracellular inducer is **allolactose** ($\text{Gal}\beta(1\rightarrow6)\text{Glc}$), a minor product of β -galactosidase action. In the laboratory one usually uses a synthetic inducer such as isopropylthiogalactoside (**IPTG**), which induces the **lactose operon** but is not cleaved by β -galactosidase. Hence, its concentration does not change during an experiment.

Regulation in the lactose operon - A mutation in a structural gene (*z*, for example) can inactivate its product (β -galactosidase) without affecting control of the other two genes. However, mutations in the regulatory regions (DNA sequences) mapping outside genes *z*, *y*, and *a* can affect expression of all three structural genes.

Operon models - The original Jacob--Monod model for gene regulation, based upon the lactose operon system, is shown schematically in **Figure 26.2**. A more complete description of the **lac operon** is shown in **Figure 26.17**. Transcription of the three structural genes is initiated near an adjacent site, the operator. Transcription yields a single polycistronic messenger RNA (that is, an RNA containing all three genes). The term cistron is used here to indicate a region of a genome that encodes one polypeptide chain.

Lac repressor - The *i* gene product of the lac operon is a macromolecular repressor which, in the active form binds to the operator, thereby blocking transcription (**Figure 26.18a**). The repressor also has a binding site for inducer. Binding of **IPTG**, allolactose, or some other inducer at this site inactivates the repressor by vastly decreasing its affinity for DNA (**Figure 26.18b**). Inactivating the repressor stimulates transcription of *z*, *y*, and *a*.. Thus, the introduction of **lactose** or a similar inducer activates synthesis of the gene products involved in its catabolism by removing a barrier to their transcription. This mode of regulation is negative, because the active regulatory element (the repressor) is an inhibitor of transcription. Positive control is also a factor, involving the CRP site shown in **Figure 26.17**.

Modifications to Model - The following three major modifications to the Jacob-Monod model occurred as the system was subjected to further analysis:

1. The promoter was discovered to be an element distinct from the operator (although the two sites overlap);
 2. Although the repressor was first thought to be *i*-gene RNA, isolating it proved that it is protein; and
 3. Jacob and Monod proposed that all transcriptional regulation was negative; that is, that binding a regulatory protein always inhibited transcription. However, the lactose operon, like many other regulated genes, also exhibits positive control of transcription; that is, binding a protein activates transcription in certain cases, as described [here](#).
-

See also: [Lac Repressor](#), [cAMP receptor protein](#)

INTERNET LINKS:

1. [The Lac Operon](#)
 2. [Induction of the Lac Operon](#)
 3. [Inducible Genes](#)
-

Allolactose

Allolactose (Gal β (1 \rightarrow 6)Glc) is a molecule that is the inducer of the lactose operon in *E. coli*.

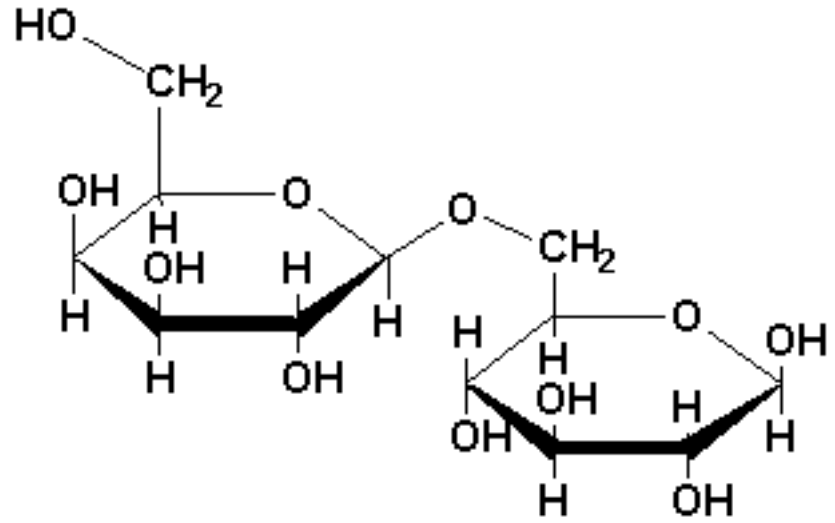

Allolactose

See also: [Lactose Operon Regulation](#), [IPTG](#)

Isopropylthiogalactoside (IPTG)

IPTG is an artificial inducer of the Lac operon. It is used in laboratories to induce the lac operon because, in contrast to **allolactose**, which is the natural inducer of the operon, **IPTG** cannot be hydrolyzed and broken down by the cell. Hence, its concentration does not change during an experiment.

See also: [Lactose Operon Regulation](#)

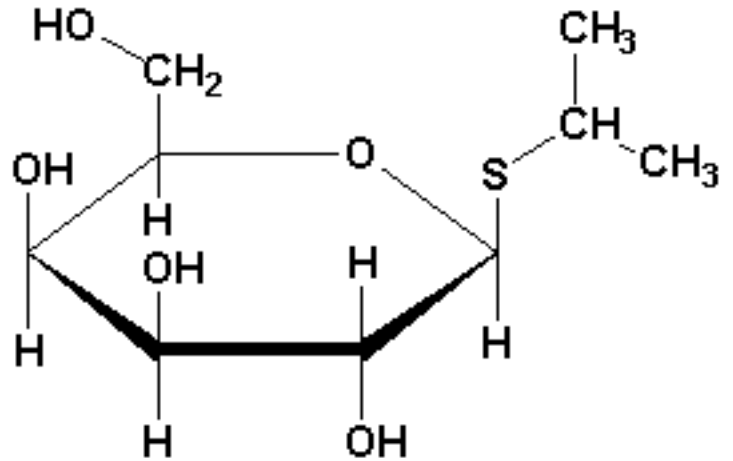

Isopropyl Thiogalactoside (IPTG)

Figure 26.2: The operon model, as proposed in 1961 by Jacob and Monod.

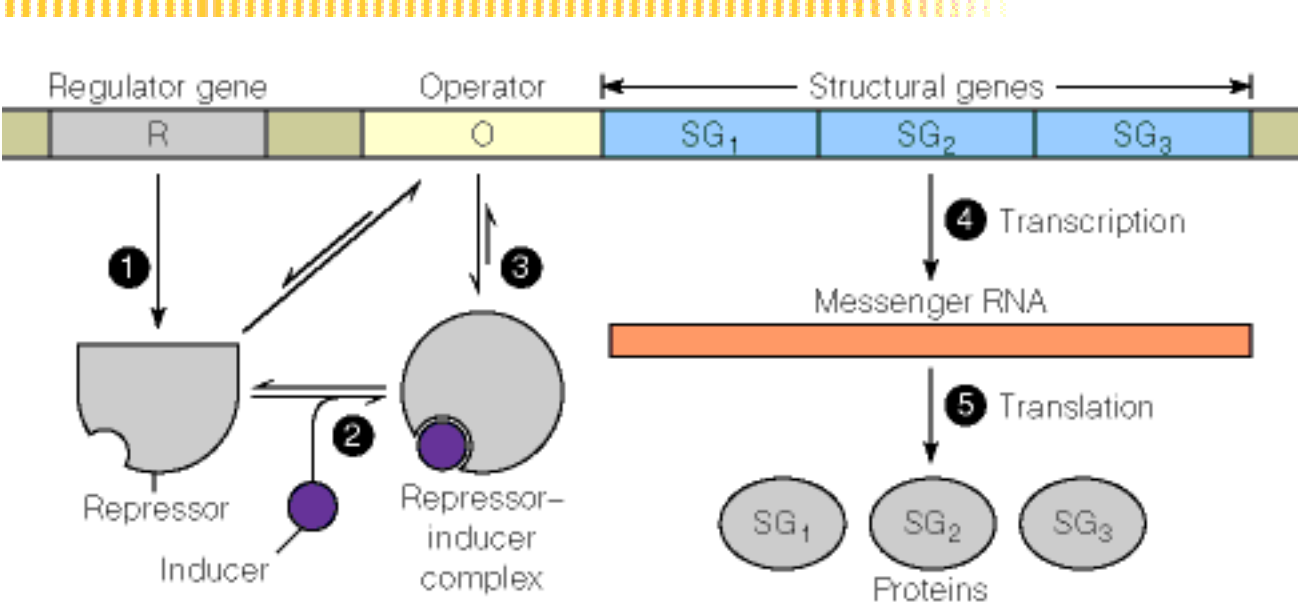

Figure 26.17: A map of the lactose operon.

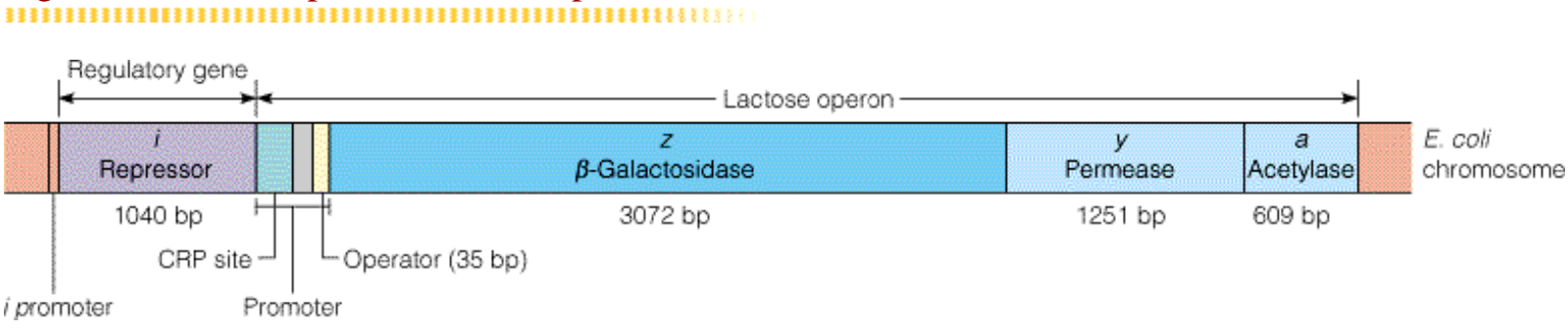
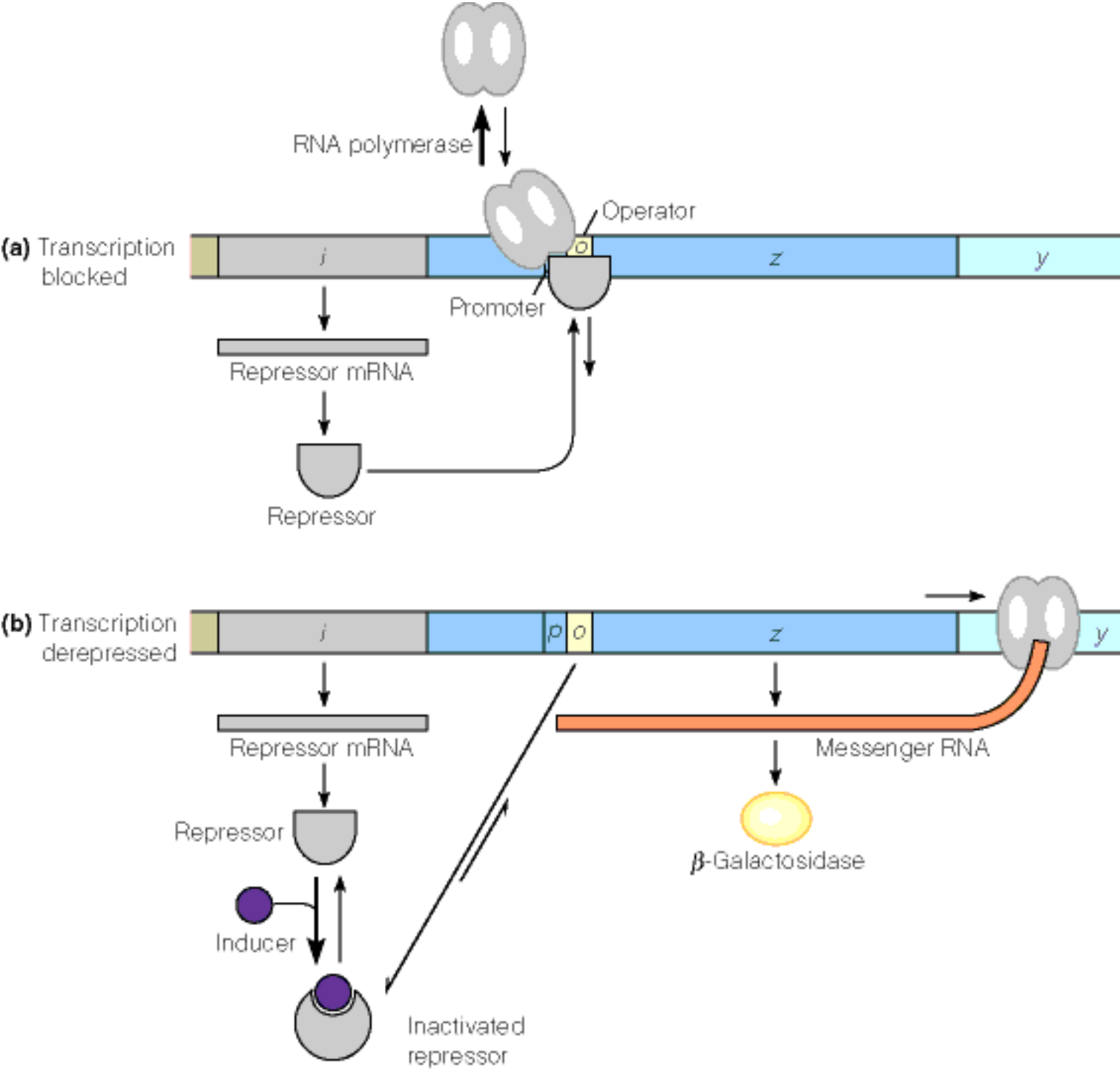

Figure 26.18: Configurations of the lactose operon.



cAMP Receptor Protein (CRP)

Negative and positive control - The lac repressor--operator system keeps the operon turned off in the absence of utilizable β -galactosides. An overlapping regulatory system ([Figure 26.21](#)) turns the operon on only when alternative energy sources are unavailable. *E. coli* uses glucose in preference to most other energy substrates. When grown in a medium containing both glucose and lactose, the cells metabolize glucose exclusively until the supply is exhausted. Then the lactose operon becomes activated in preparation for continued growth using lactose. This phenomenon involves a transcriptional activation mechanism, which occurs when glucose levels are low. Control is exerted through intracellular levels of cyclic AMP.

cAMP controls in *E. coli* - In *E. coli*, [cAMP](#) levels are low when intracellular [glucose](#) levels are high. [Adenylate cyclase](#) (the enzyme that catalyzes formation of cAMP) apparently senses the intracellular level of an unidentified intermediate in glucose catabolism. Hence, the current name for the regulatory process is catabolite activation. When glucose levels drop, as shown in [Figure 26.21](#), cAMP levels rise and cAMP interacts with a protein called **cAMP receptor protein (CRP)**. When it binds cAMP, **CRP** undergoes a conformational change. The change greatly increases its affinity for certain DNA sites, including a site in the lac operon adjacent to the RNA polymerase binding site. Binding of cAMP--**CRP** at this site protects a DNA sequence from -68 to -55, as shown in [Figure 26.19](#). This binding facilitates transcription of the *lac* operon by stimulating the binding of RNA polymerase to form a closed-promoter complex.

The cAMP--**CRP** complex activates several different gene systems in *E. coli*, all of them involved with energy generation. They include operons for utilization of other sugars, including [galactose](#), [maltose](#), [arabinose](#), and [sorbitol](#), and several amino acids. Among the operons that have been analyzed, the DNA binding site of the cAMP-activated dimer varies considerably with respect to the transcriptional start point, suggesting that regulatory mechanisms involving this protein are complex.

The CRP - DNA Complex - The structure of the **CRP**-cAMP-DNA complex, as revealed by x-ray crystallography, shows how the protein binds to DNA. Each **CRP** subunit contains a characteristic pair of α helices, called a helix-turn-helix structural motif (see [Figure 28.23](#)). It is found in several DNA-binding regulatory proteins, suggesting common evolutionary origins for this family of proteins. Analysis of the DNA - protein complex shows that **CRP** induces DNA to bend quite sharply when it binds. This bending may facilitate the initiation of transcription by bringing DNA sequences farther upstream into direct contact with the promoter or transcriptional start site.

See also: [Lactose Operon Regulation](#), [Lac Repressor](#), [Transcription Regulation in Phage \$\lambda\$](#) , [Structure of Cro and cI Repressors](#)

INTERNET LINK: [*E. coli* cAMP Receptor Protein](#)

Figure 26.21: Activation of the lac operon.

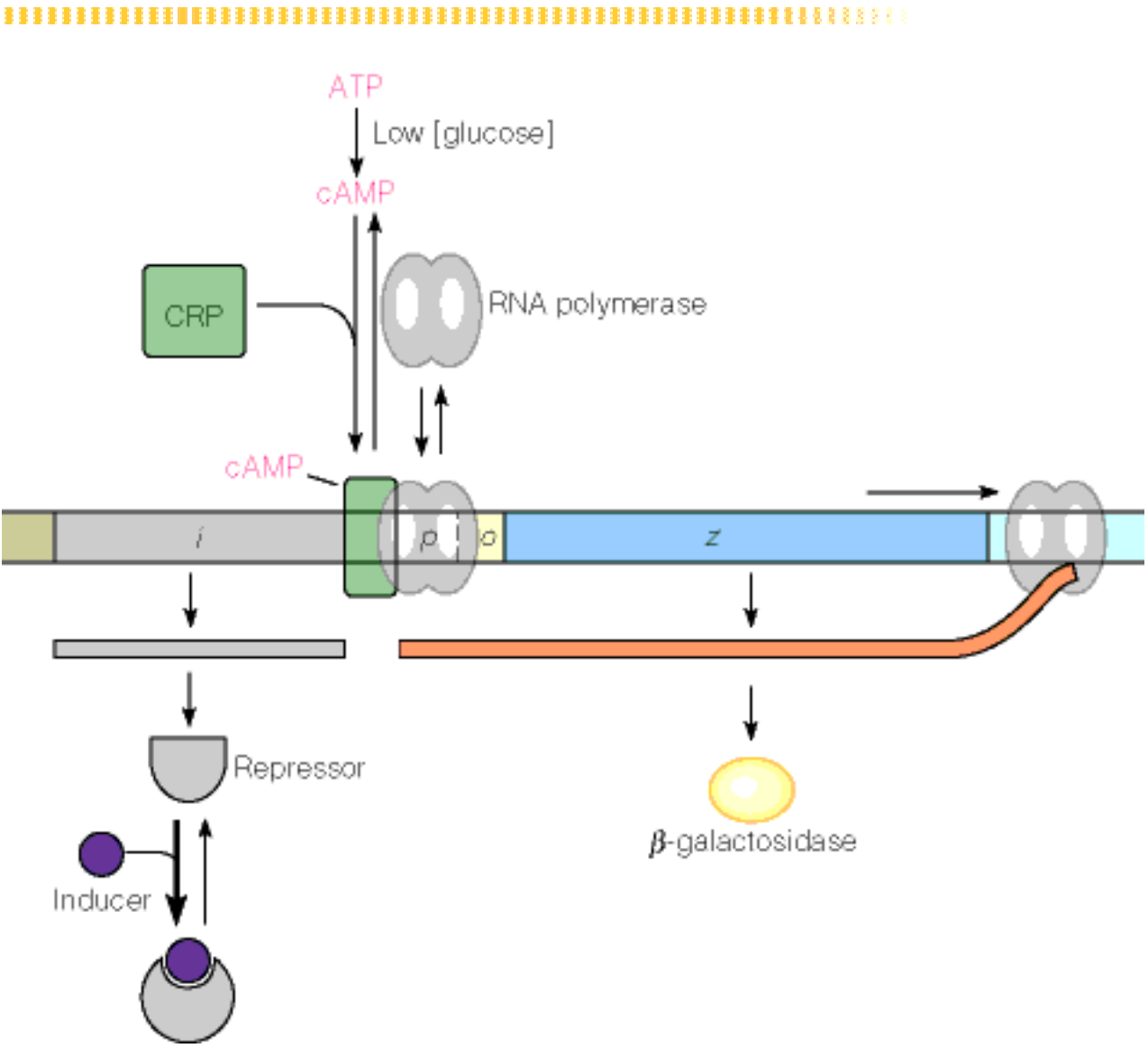

Cyclic Adenosine Monophosphate (cAMP)

Hormones act through binding to specific cellular receptors. Second messengers are often used to transmit the hormonal message to the target metabolic pathway. **cAMP** is one such second messenger. **Cyclic AMP** - dependent signal transduction mechanisms involve three separate proteins: (1) a hormone receptor, (2) **adenylate cyclase**, and (3) a G protein (see [here](#)).

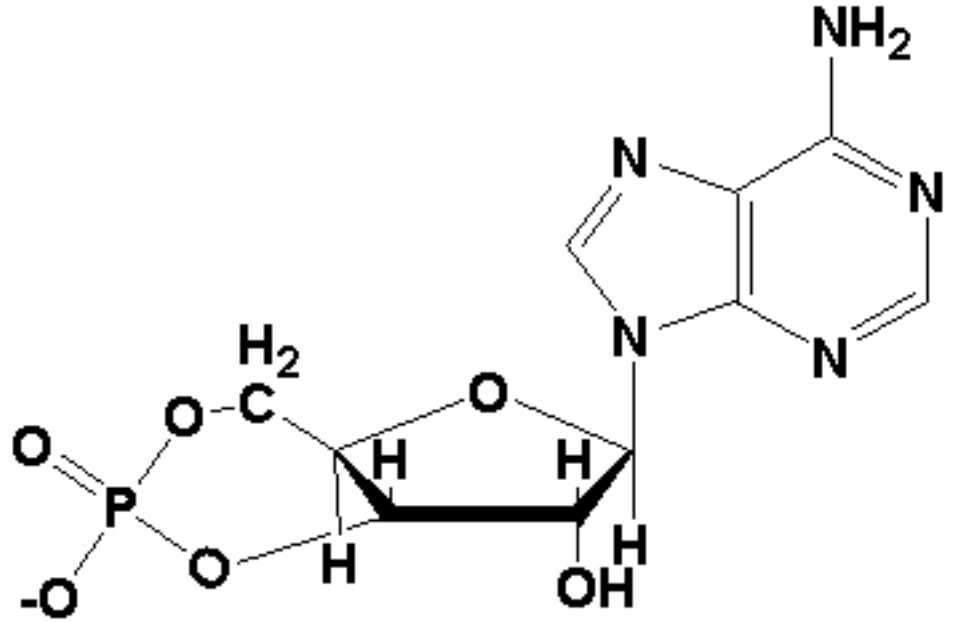

Cyclic adenosine monophosphate (cAMP)

cAMP acts to stimulate the **kinase cascade** (see [Figure 13.18](#), [Figure 16.11](#)) by binding to the **cAMP-dependent protein kinase**. This activates the enzyme and initiates the serial phosphorylation of **phosphorylase b kinase** and **glycogen phosphorylase b**, which leads to phosphorolysis of **glycogen** to yield **glucose-1-phosphate**.

Coincident with stimulating glycogen breakdown, **cAMP** exerts two effects in inhibiting glycogen synthesis: (1) phosphorylation of **glycogen synthase**, causing its inactivation, and (2) inhibition of **phosphoprotein phosphatase (PP-1)**, whose activity would tend to restore activity of glycogen synthase. PP-1 and other phosphoprotein phosphatases play converse roles in glycogenolysis, in which dephosphorylation of **glycogen phosphorylase b kinase** (SPK) causes its inactivation.

Effects on Glycolysis/Gluconeogenesis

cAMP ultimately controls the level of **fructose-2,6-bisphosphate** (the most potent allosteric regulator of **glycolysis** and **gluconeogenesis**) through the action of **cAMP-dependent protein kinase** to interconvert **PFK-2** and **fructose-2,6-bisphosphatase** by phosphorylation.

Reactions involving cAMP



cAMP + H₂O \rightleftharpoons **AMP** (catalyzed by a phosphodiesterase)

See also: **Epinephrine**, **Glucagon**, **Action of Glucagon**, **G Proteins and Signal Transduction**

Adenylate Cyclase

Adenylate cyclase is a membrane-bound enzyme that, after stimulation by a **G protein**, catalyzes formation of cAMP from ATP (see below). cAMP, thus formed, stimulates activation of a **kinase cascade** that affects several metabolic pathways, such as glycogen metabolism (see **here**) and **gluconeogenesis**. **Adenylate cyclase** plays an important role in signal transduction.



See also: [Figure 13.18](#), [Figure 16.11](#), [Action of Epinephrine](#), [G Protein Families and Subunits](#), [G Proteins and Signal Transduction](#)

G Proteins and Signal Transduction

Signal transduction is the process whereby information from outside the cell is conveyed into the cell. This often involves messenger systems. One such system involves a first messenger, such as a hormone, which binds to a cell surface receptor. The binding stimulates production of a second messenger inside the cell. Several molecules have been implicated as second messengers. A widely used one is cyclic AMP (**cAMP**). cAMP-dependent signal transduction mechanisms involve three separate proteins:

1. A hormone receptor;
2. **Adenylate cyclase**; and
3. A **G protein** (**Figure 23.12**)

G proteins are named based on their ability to bind guanine nucleotides. **G proteins** are membrane proteins that in the inactive state bind guanosine diphosphate (**GDP**). **G proteins** are required for activation of adenylate cyclase by β -adrenergic agonists via interactions with receptor systems that activate or inhibit adenylate cyclase. Of the several known **G proteins** the two best characterized are **Gs**, a family of **G proteins** involved in stimulation of adenylate cyclase, and **Gi**, a closely related family involved in responses that inhibit adenylate cyclase. Both types of **G proteins** interact with other receptors as well and with target proteins other than adenylate cyclase.

In summary, the signal transduction pathway involves the following steps:

1. Binding of extracellular hormone or agonist to a receptor, typically a β -adrenergic receptor - causes a conformational change in the receptor that stimulates it to interact with a nearby molecule of **Gs**.
2. This in turn stimulates an exchange of bound GDP for GTP--that is, the dissociation of GDP from **Gs**, to be replaced by **GTP** (see **here**). A class of protein factors called guanine nucleotide exchange factors (GEF) assists in the exchange of GDP and GTP.
3. **Gs** is thereby converted to a protein that activates adenylate cyclase, producing cyclic AMP from **ATP**.
4. This results in activation of **cAMP-dependent protein kinase** (protein kinase A), with consequent phosphorylation of target proteins, such as **phosphorylase b kinase** in cells that activate **glycogen phosphorolysis**.
5. Phosphorylation of target enzymes results in stimulation or inhibition of metabolic

reactions.

Continued activation of **Gs** depends on the presence of bound GTP.

The hormonal response is limited, and hence is controlled by the presence of a slow GTPase activity on the **G protein**. Thus, bound GTP is slowly cleaved to GDP, with concomitant loss of the ability to stimulate adenylate cyclase. This process is assisted by a GTPase-activating protein (GAP).

The **Gi** protein functions similarly, but it responds to extracellular signals whose response is the inhibition of adenylate cyclase, typically α_2 agonists. Here the binding of GTP provokes an inhibitory interaction of **Gi** with adenylate cyclase, which decreases the synthesis of cAMP.

See also: [G Protein Families and Subunits](#), [Signal Transduction Agonists and Antagonists](#), [G proteins in vision](#), [Figure 12.13](#), [Metabolic Control Mechanisms](#) (from Chapter 12)

INTERNET LINKS:

1. [G Protein Receptor Coupled Database](#)
 2. [G Protein Coupled Receptors Point Mutation Database](#)
-

Figure 23.12: The cycle of G protein dissociation and reassociation.

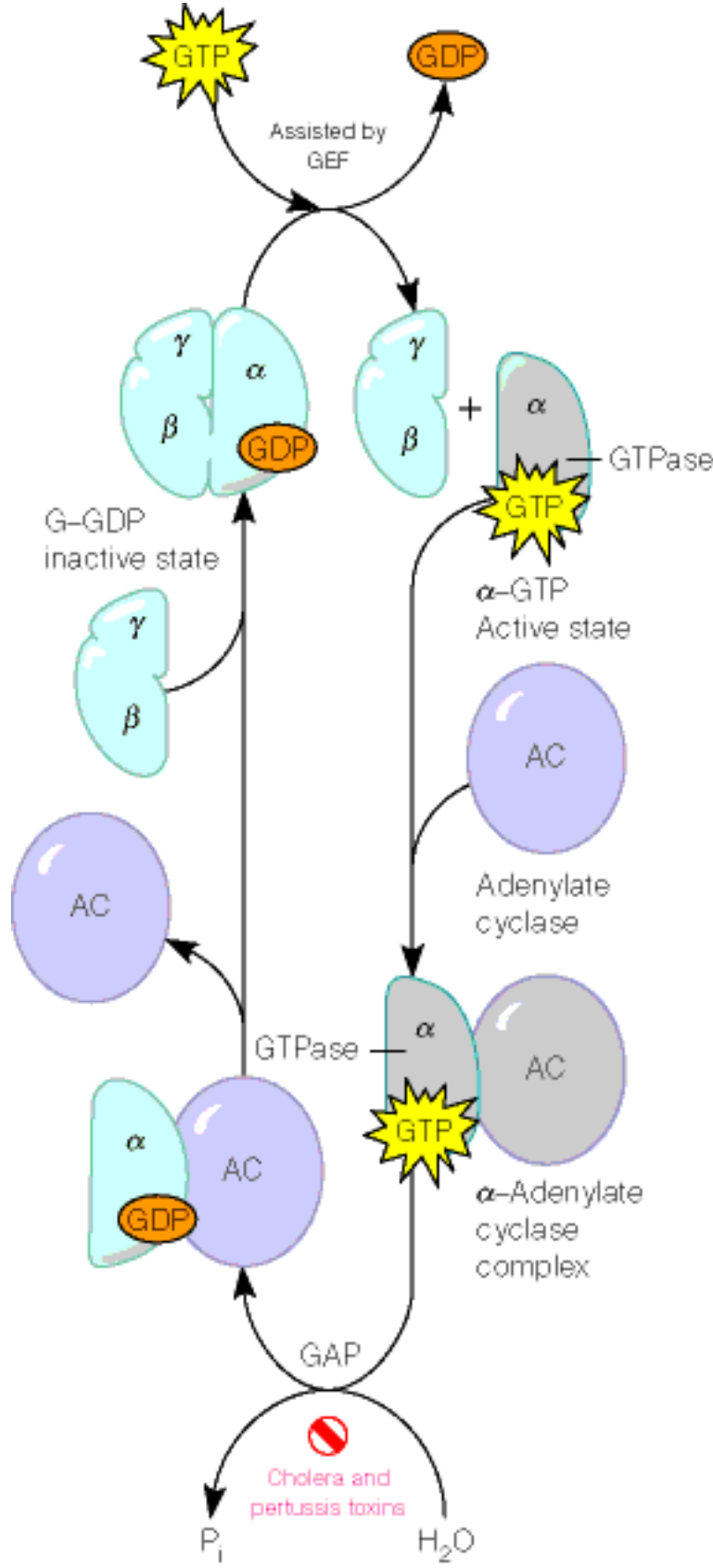

Guanosine Diphosphate (GDP)

GDP is nucleotide intermediate in synthesis of **GTP**. **GDP** is produced from **GMP** via the reaction below catalyzed by **guanylate kinase**:

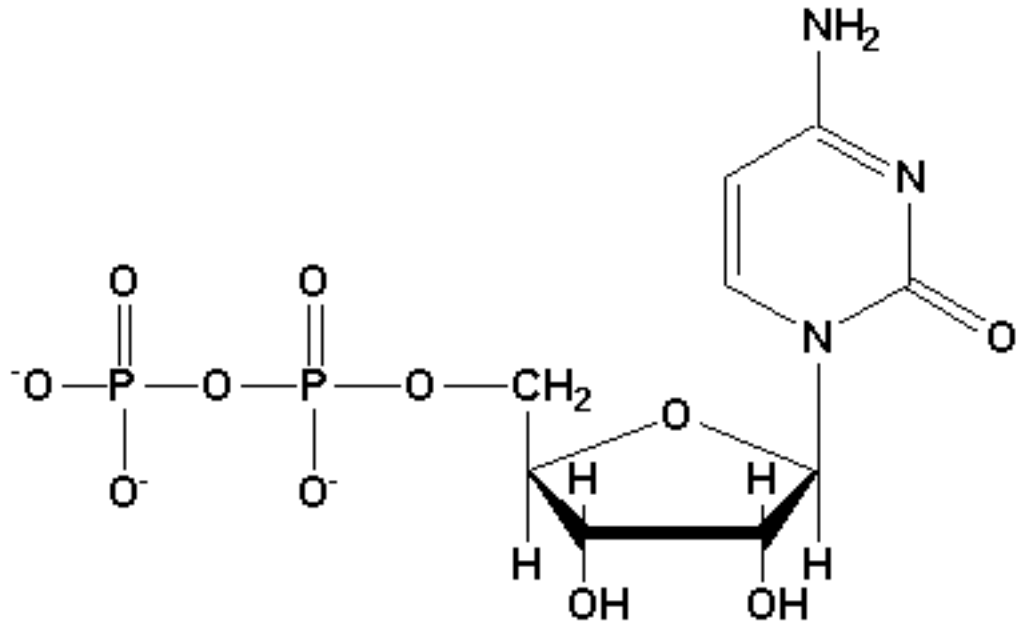

Guanosine Diphosphate (GDP)

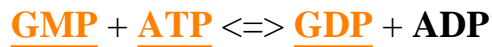

The interconversions of **GTP** and **GDP** by the G-proteins is a critical component of controlling cellular processes (see here)

See also: [GTP](#), [Nucleotides](#), [Guanine](#), [Nucleotide Salvage Synthesis](#), [De Novo Biosynthesis of Purine Nucleotides](#)

Guanylate Kinase

Guanylate kinase is an enzyme that catalyzes the reaction below:

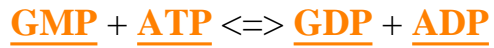

A similar reaction is catalyzed by [adenylate kinase](#) (see [here](#) also). The **guanylate kinase**-catalyzed reaction is part of *de novo* purine biosynthesis and can occur as part of purine salvage synthesis as well.

See also: [De Novo Biosynthesis of Purine Nucleotides](#), [Salvage Routes to Deoxyribonucleotide Synthesis](#)

Guanosine Monophosphate (GMP)

Guanosine monophosphate (GMP) is an important intermediate both in the *de novo* synthesis and salvage synthesis of GTP. It is also formed as a result of hydrolysis of cGMP, which is an important second messenger in cellular signalling mechanisms, particularly involved in vision.

In nucleotide synthesis, **GMP** is formed from phosphoribosyl pyrophosphate in the first reaction below catalyzed by a phosphoribosyl transferase:

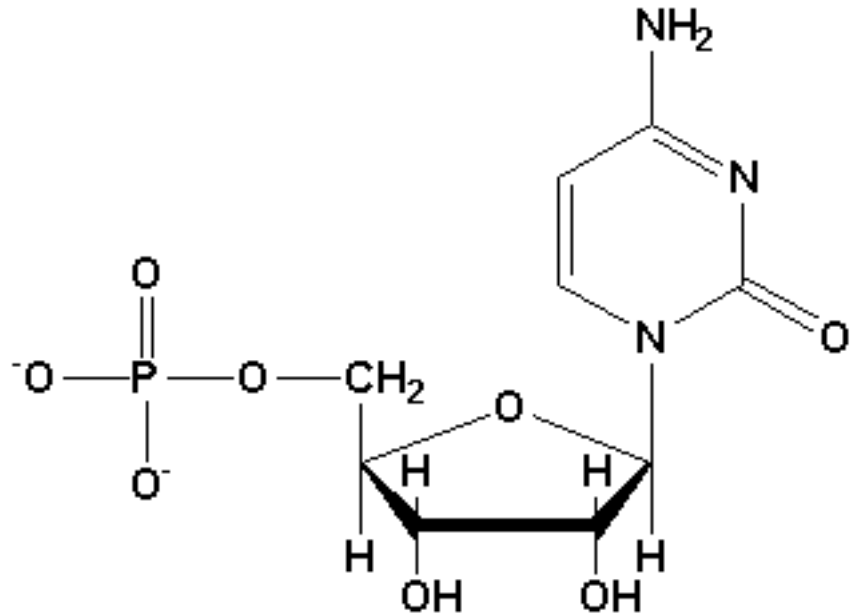
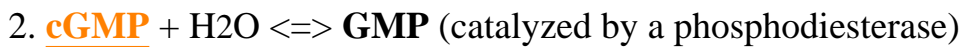

Guanosine Monophosphate (GMP)

GMP is also made in the *de novo* biosynthetic pathway of purine nucleotide biosynthesis from **xanthosine monophosphate**, as shown in **Figure 22.6**.

See also: [Nucleotides](#), [Guanine](#), [De Novo Biosynthesis of Purine Nucleotides](#), [G Proteins in Vision](#)

Ribose-5-Phosphate

Ribose-5-phosphate is a pentose phosphate pathway intermediate produced by phosphopentose isomerase-catalyzed rearrangement of ribulose-5-phosphate.

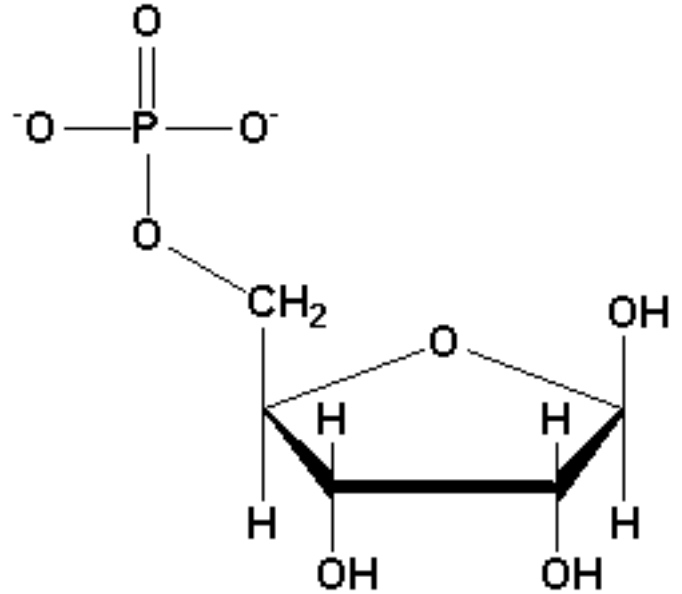

D-Ribose-5-phosphate

Ribose-5-phosphate is an intermediate in the [Calvin cycle](#) and in synthesis of [5-phosphoribosyl-1-pyrophosphate](#), an intermediate in nucleotide biosynthesis.

See also: [Pentose Phosphate Pathway](#), [Pentose Phosphate Pathway Intermediate](#), [Phosphopentose Isomerase](#), [The Importance of PRPP](#)

INTERNET LINKS:

1. [Pentose Phosphate Pathway](#)
 2. [Carbon Fixation](#)
-

Calvin Cycle Reactions

The **reactions of the Calvin cycle**, which is the process of carbon dioxide fixation in plants (also known as the dark cycle), are listed below:

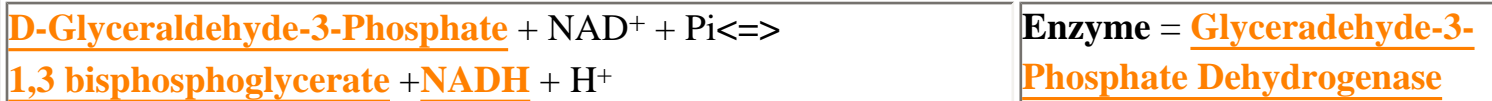



Enzyme =
Ribulose-5-
Phosphate Kinase

See also: [Calvin Cycle](#), [Pentose Phosphate Pathway](#), [Regulation of Photosynthesis](#)

INTERNET LINKS:

1. [Pentose Phosphate Pathway](#)
 2. [CO₂ Fixation](#)
-

1,3-Bisphosphoglycerate (1,3BPG)

1,3BPG is an intermediate of [glycolysis](#), [gluconeogenesis](#), and the [Calvin cycle](#), **1,3BPG** is acted on by the enzymes [glyceraldehyde-3-phosphate dehydrogenase](#) and [phosphoglycerate kinase](#).

The acyl-phosphate group at position 1 is much more energy rich than the phosphate anhydride of [ATP](#), so **1,3BPG** has the energy to drive synthesis of ATP from [ADP](#) + Pi, which it does in the glycolysis reaction catalyzed by the enzyme phosphoglycerate kinase.

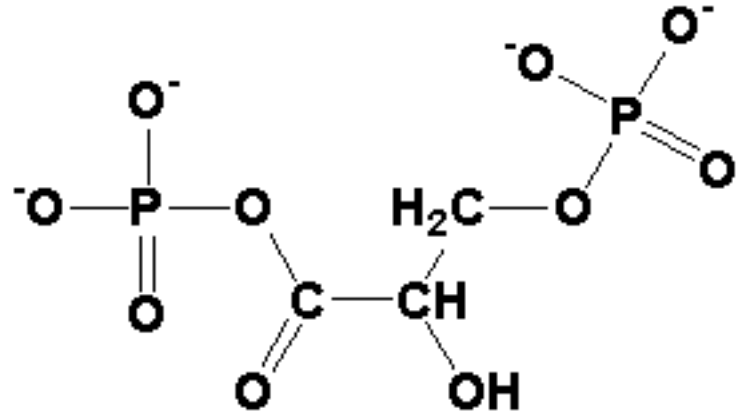

1,3-Bisphosphoglycerate

See also: [Enzymes of Glycolysis](#), [Factors Contributing to Large Energies of Hydrolysis of Phosphate Compounds](#)

INTERNET LINK: [Glycolysis/Gluconeogenesis](#)

Glyceraldehyde-3-Phosphate Dehydrogenase (G3PDH)

G3PDH catalyzes the oxidation/reduction of D-glyceraldehyde-3-phosphate (G3P) and 1,3-bisphosphoglycerate (1,3BPG).



The $\Delta G^{\circ'}$ of the enzymatic reaction is sufficiently low for it to be used in [glycolysis](#), [gluconeogenesis](#), and the [Calvin cycle](#).

The reaction involves a two-electron oxidation of the carbonyl carbon of G3P to the carboxyl level, a reaction that is normally quite exergonic. However, the overall reaction is slightly endergonic (under standard conditions), because the enzyme utilizes most of the energy released to drive the synthesis of a super-high-energy compound, 1,3BPG. This compound contains a carboxylic-phosphoric acid anhydride group at position 1, a functional group with a very high standard free energy of hydrolysis, -49.4 kJ/mol.

Because the acyl-phosphate group is much more energy rich than the phosphate anhydride of ATP, 1,3BPG can drive the synthesis of ATP from ADP. Indeed, it does so in the glycolysis reaction catalyzed by the enzyme phosphoglycerate kinase.

Inhibition of glycolysis by iodoacetate and heavy metals, such as mercury, occurs because each of these compounds reacts with the free sulfhydryl groups of **G3PDH**. As shown in [Figure 13.5](#), formation of a thiohemiacetal group involving a cysteine thiol group on **G3PDH** as an essential catalytic intermediate explains this earlier observation.

[Previous step](#) of glycolysis; [Next step](#) of glycolysis;

See also: [Reactions/Energies of Glycolysis](#), [Reaction Picture](#)

INTERNET LINKS:

1. [RasMol Structure \(slow\)](#)
 2. [Glycolysis/Gluconeogenesis](#)
-

D-Glyceraldehyde-3-Phosphate (G3P)

G3P is an intermediate in glycolysis, gluconeogenesis, pentose phosphate pathway, and the Calvin cycle.

G3P participates in the reactions below:

1. **D-Fructose-1,6-Bisphosphate** \rightleftharpoons **DHAP** + **G3P**
(catalyzed by **Fructose-1,6-Bisphosphate Aldolase**)

2. **DHAP** \rightleftharpoons **G3P** (catalyzed by **Triose Phosphate Isomerase**)

3. **G3P** + **NAD⁺** + Pi \rightleftharpoons **1,3 Bisphosphoglycerate** + **NADH** + H⁺ (catalyzed by **Glyceraldehyde-3-Phosphate Dehydrogenase**)

In the pentose phosphate pathway **G3P** participates in the reactions below:

1. **Xylulose-5-Phosphate** + **Ribose-5-Phosphate** \rightleftharpoons **G3P** + **Sedoheptulose-7-Phosphate** (catalyzed by **Transketolase**)

2. **G3P** + **Sedoheptulose-7-Phosphate** \rightleftharpoons **Erythrose-4-Phosphate** + **Fructose-6-Phosphate**
(catalyzed by **Transaldolase**)

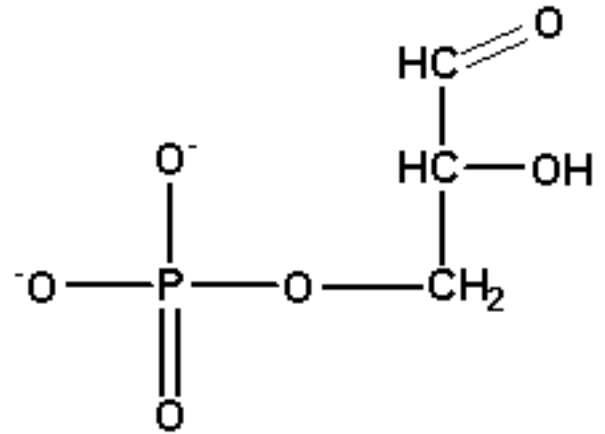

Glyceraldehyde-3-phosphate

See also: **Glycolysis**, **Gluconeogenesis**, **Pentose Phosphate Pathway**, and the **Calvin cycle**.

D-Fructose-1,6-Bisphosphate (F1,6BP)

F1,6BP is an intermediate of glycolysis, gluconeogenesis, and the Calvin cycle. It is acted on by the enzymes [aldolase](#), [phosphofructokinase](#), and [fructose 1,6 bisphosphatase](#).

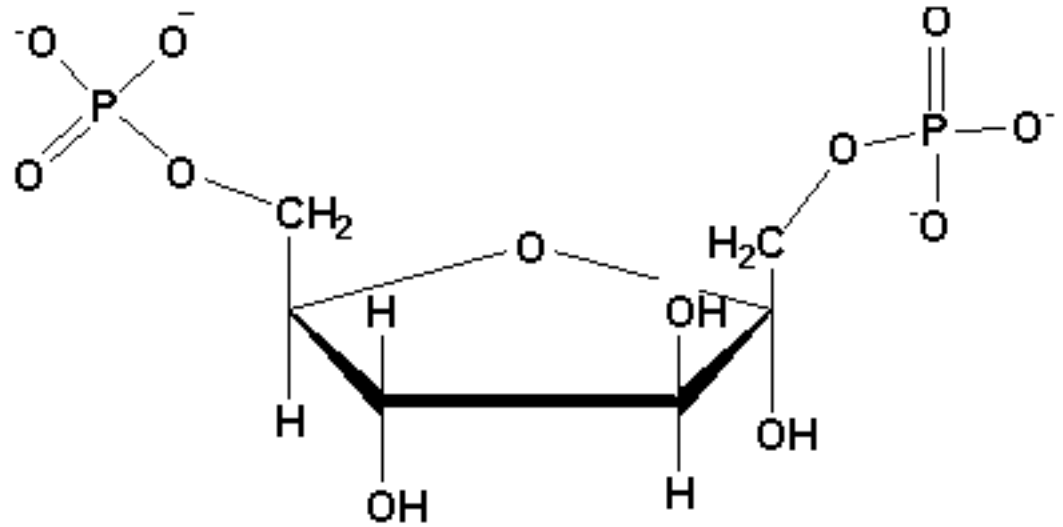

Fructose-1,6-bisphosphate

F1,6BP is a feedforward activator of [pyruvate kinase](#).

See also: [Glycolysis](#), [Gluconeogenesis](#)

Fructose-1,6-Bisphosphate Aldolase

Fructose-1,6-bisphosphate aldolase or, as it is more commonly known, **aldolase**, is a tetrameric protein catalyzing the cleavage of fructose-1,6-bisphosphate (F1,6BP) to dihydroxyacetone phosphate (DHAP) and D-glyceraldehyde-3-phosphate (G3P).



The reaction is common to both glycolysis and gluconeogenesis.

The $\Delta G^{\circ'}$ of the reaction indicates a strongly endergonic reaction under standard state conditions, but intracellular substrate concentrations (determined in rabbit skeletal muscle) reveal an overall ΔG of -1.3 kJ/mol, consistent with flux in the direction of cleavage normally. Under conditions in which gluconeogenesis is favored, the reaction can be readily reversed to favor F1,6BP formation. Thus, aldolase functions in both glycolysis and gluconeogenesis.

A different kind of aldolase activity in the liver, called **Aldolase B**, acts on fructose-1-phosphate to yield dihydroxyacetone phosphate and D-glyceraldehyde.

[Previous step](#) of glycolysis; [Next step](#) of glycolysis

See also: [Glycolysis](#), [Gluconeogenesis](#), [Aldolase B](#), [Fructose-1-Phosphate](#), [D-Glyceraldehyde](#)

INTERNET LINKS:

1. [RasMol Image \(slow\)](#)
 2. [Glycolysis/Gluconeogenesis](#)
-

Dihydroxyacetone Phosphate (DHAP)

An intermediate in [glycolysis](#), [gluconeogenesis](#), glycerophospholipid, glycerol metabolism, phosphatidic acid synthesis, fat metabolism, and the [Calvin Cycle](#).

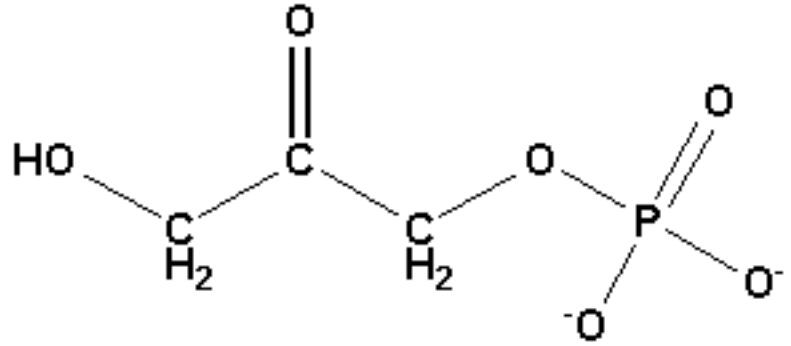

Dihydroxyacetone Phosphate (DHAP)

DHAP is also employed in the glycerophosphate shuttle, which functions as an electron-transporting mechanism in insect muscle ([Figure 15.11a](#)).

Enzymes that act on **DHAP** include the following:

[Glyceraldehyde-3-phosphate dehydrogenase](#)

[Triosephosphate Isomerase](#)

[Glycerol-3-Phosphate Dehydrogenase](#)

[Aldolase](#)

[Aldolase B](#)

See also: [Glycerophospholipid Metabolism in Eukaryotes](#)

Figure 15.11: Shuttles for transfer of reducing equivalents from cytosol into mitochondria.

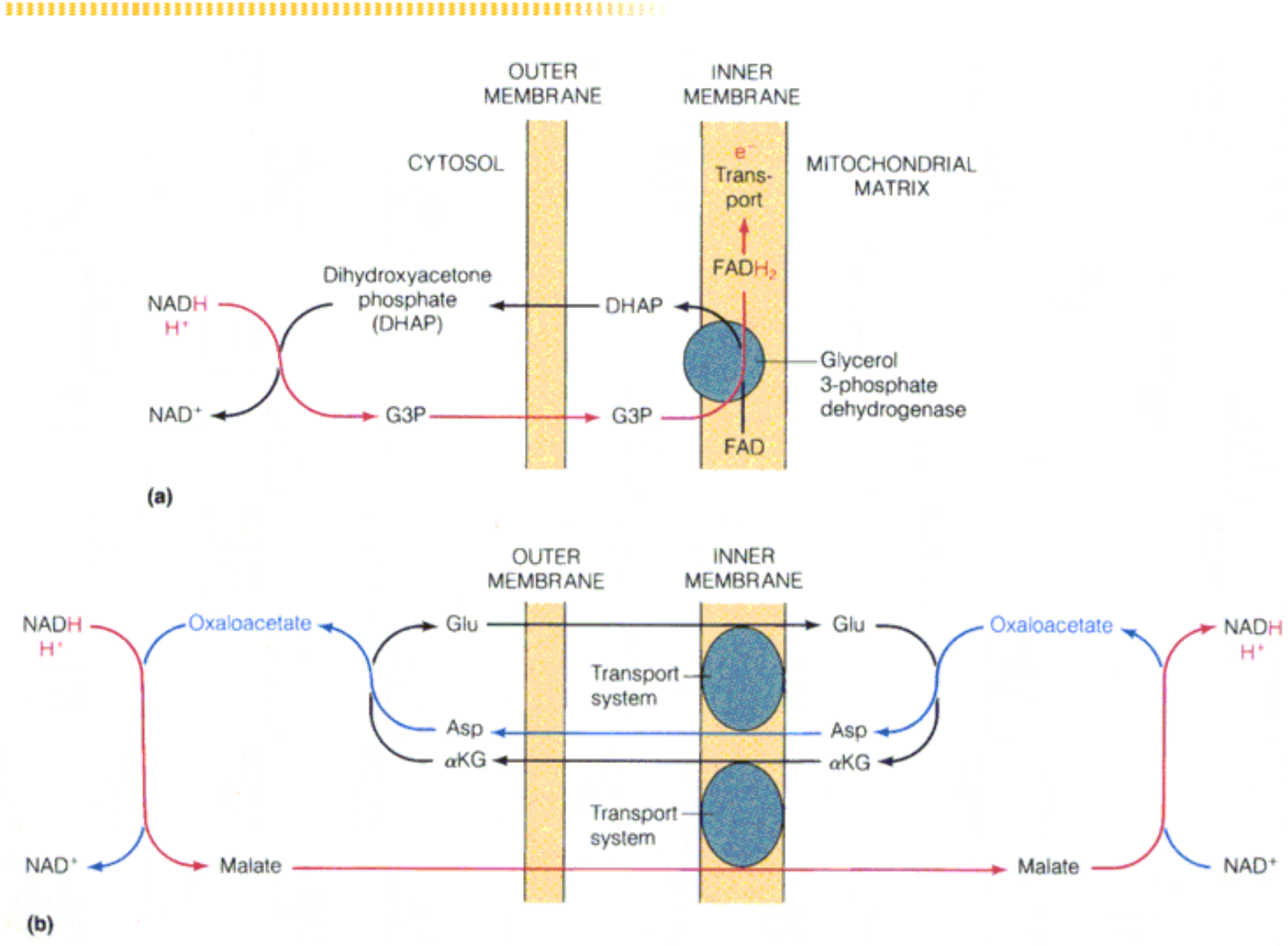

Triose Phosphate Isomerase (TPI)

TPI catalyzes interconversion of dihydroxyacetone phosphate (DHAP) and glyceraldehyde-3-phosphate (G3P) (see [here](#)).



Standard state conditions favor formation of DHAP, but the intracellular concentration of glyceraldehyde-3-phosphate is low in the cell, drawing the reaction toward G3P. The reaction, which is common to glycolysis and gluconeogenesis, is also useful in glycerol metabolism.

The enzyme is a dimer of two identical subunits, each possessing a parallel β barrel with α helices in the interconnecting loops. The active site lies near the top of the barrel and can accommodate either glyceraldehyde-3-phosphate or dihydroxyacetone phosphate. The active site of **TPI** includes a [glutamate](#) residue (Glu 165) that has been found essential for the function of the enzyme. This glutamate is negatively charged (therefore basic) at physiological pH and helps to extract the proton from carbon 2. At the same time an acidic, proton-donating group (HA) shuttles protons between the substrate's carbonyl group and the -OH on C-2. Thus the reaction seems to proceed via an enediol intermediate.

Other groups surrounding the substrate help to stabilize the enediol intermediate. These include Lys 12 and His 95.

[Previous step](#) of glycolysis; [Next step](#) of glycolysis

See also: [Enzymes of Glycolysis](#), [Glycolysis](#), [Gluconeogenesis](#), [Glycerol Metabolism](#), [Molecules of Glycolysis](#)

INTERNET LINKS:

1. [RasMol Image of TPI](#) (slow)
 2. [Glycolysis/Gluconeogenesis](#)
-

Unnumbered Item

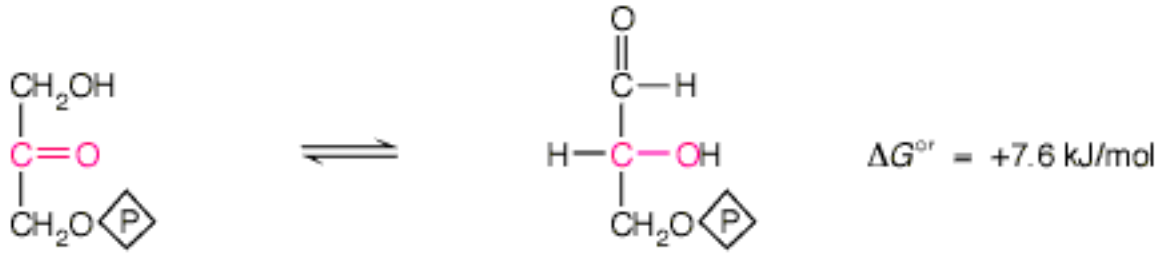

Dihydroxyacetone phosphate

D-Glyceraldehyde-3-phosphate

Reactions/Energies of Glycolysis

Reactions/Energies of Glycolysis

There are ten steps to glycolysis. Most instructors require students to memorize the molecular structures and enzyme names for each reaction of glycolysis, because it is such a universally important pathway. You should clarify this with your instructor. The [Quizzing section](#) is a convenient way to learn these things.

Highlights of the reactions:

Reaction #1



Enzyme: [Hexokinase](#)

Notes - ATP energy is used. Hexokinase is capable of phosphorylating other 6-carbon sugars similarly, such as galactose, fructose, and mannose.

$$\Delta G^{\circ'} = -16.7 \text{ kJ/mol}$$

$\Delta G^{\circ'}$ is negative, so it favors making glucose-6-phosphate (G6P), but the product of the reaction (G6P) can reach high enough concentration to inhibit hexokinase and limit glycolysis.

[Reaction Picture](#)

Reaction #2

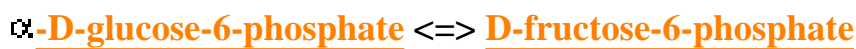

Enzyme:
[Phosphoglucoisomerase](#)

This is an aldose-ketose isomerization that proceeds through an enediol intermediate. G6P is the aldose and fructose-6-phosphate (F6) is the ketose. Phosphoglucoisomerase, which catalyzes this isomerization, must not be confused with phosphoglucomutase, the enzyme that interconverts G6P and glucose-1-phosphate (G1P). The $\Delta G^{\circ'}$ for the isomerization of G6P to F6P is only slightly positive, so it strongly favors neither reactants nor products in this reaction.

$$\Delta G^{\circ'} = +1.7 \text{ kJ/mol}$$

[Reaction Picture](#)

Reaction #3

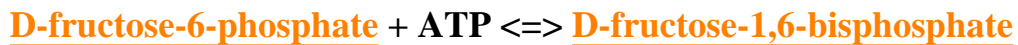

Enzyme:
Phosphofructokinase

ATP energy is used to phosphorylate F6P to fructose-1,6-bisphosphate (F1,6BP). This reaction is the key to understanding how regulation of glycolysis is regulated. The enzyme, phosphofructokinase (PFK), is allosterically regulated by AMP (on), ADP (on), ATP (off), citrate (off), and fructose-2,6-bisphosphate (F2,6BP) (on). The most potent of these is F2,6BP. The $\Delta G^{\circ'}$ of -14.2 kJ/mol favors formation of F1,6BP fairly strongly. Consequently, the reaction is essentially irreversible in vivo. At this point all of the energy inputs for glycolysis are complete.

$$\Delta G^{\circ'} = -14.2 \text{ kJ/mol}$$

Reaction Picture

Reaction #4

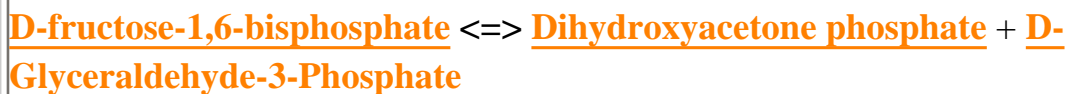

Enzyme: Fructose-1,6-Bisphosphate Aldolase

In this reaction, F1,6BP is cleaved to yield two three-carbon intermediates, glyceraldehyde-3-phosphate (G3P) and dihydroxyacetone phosphate (DHAP). The large positive $\Delta G^{\circ'}$ (+23.9 kJ/mol) strongly favors the reverse reaction under conditions where reactants and products are present in relatively equal quantities. In muscle, however, the concentrations of G3P and DHAP are kept low enough that the forward reaction is favored overall. This is a good example of how a reaction that is unfavorable at standard state conditions can be made favorable in the cell by removing products as they are formed.

$$\Delta G^{\circ'} = +23.9 \text{ kJ/mol}$$

Reaction Picture
Reaction Mechanism

Reaction #5

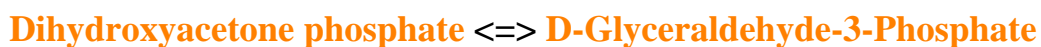

Enzyme: Triose Phosphate Isomerase

Notes - The isomerization of DHAP to G3P, like the isomerization of G6P to F6P (reaction 2 above), proceeds through an enediol intermediate. Additionally, the isomerization of DHAP also has a positive $\Delta G^{\circ'}$, but the reaction is pulled to the right by keeping the cellular concentration of G3P very low. This reaction marks the end of what is referred to as the energy investment phase, although the last ATP energy was used in reaction 3.

$$\Delta G^{\circ'} = +7.6 \text{ kJ/mol}$$

For all reactions that follow in this section, keep in mind that the six-

carbon glucose has been split into two three-carbon units. Thus, to account for everything properly, remember that there are two of each three carbon compound in the reactions shown.

[Reaction Picture](#)

Reaction #6



Enzyme: [Glyceradehyde-3-Phosphate Dehydrogenase](#)

Notes - In this reaction, G3P is phosphorylated and oxidized, so something (NAD^+) must be concomitantly reduced. As a result, the NAD^+/NADH balance in the cell is important. If the concentration of NAD^+ is low, the reverse reaction is favored, preventing glycolysis from occurring aerobically. Instead it must occur anaerobically. Thus this reaction determines whether glycolysis occurs aerobically or anaerobically. 1,3-bisphosphoglycerate (1,3BPG), the reaction product, contains an acylphosphate group, which has a standard free energy of hydrolysis of 49.4kJ/mol. Thus, 1,3BPG is capable of synthesizing ATP via a substrate-level phosphorylation. The slightly positive $\Delta G^{\circ'}$ shows that the reverse reaction is slightly favored at standard conditions. In the cell, however, the forward reaction is favored, thanks partly to the high NAD^+/NADH ratio normally present. Note also that the NADH produced in this reaction can be used to make three molecules of ATP in aerobic glycolysis (when oxidative phosphorylation is occurring). Finally, glyceraldehyde-3-phosphate dehydrogenase uses a thiol group in catalysis, which can be inhibited by iodoacetate and heavy metals, such as mercury.

$$\Delta G^{\circ'} = +6.3 \text{ kJ/mol}$$

[Reaction Picture](#)

[Show Mechanism](#)

Reaction #7



Enzyme: [Phosphoglycerate Kinase](#)

Notes - This reaction is a substrate-level phosphorylation of ADP to produce 3-phosphoglycerate (3PG) and the first ATP of glycolysis. Because two molecules of ATP are produced per molecule of glucose, the net yield of ATP is zero at this stage of glycolysis.

$$\Delta G^{\circ'} = -18.8 \text{ kJ/mol}$$

[Reaction Picture](#)

Reaction #8

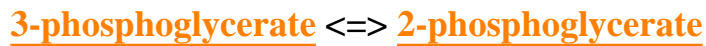

Enzyme:
[Phosphoglycerate Mutase](#)

Notes - The $\Delta G^{\circ'}$ for the isomerization slightly favors formation of 3PG over 2PG under standard conditions, but in the cell the concentration of 3PG is kept high relative to the concentration of 2PG, which drives the reaction to the right.

$$\Delta G^{\circ'} = +4.4 \text{ kJ/mol}$$

[Reaction Picture](#)

Reaction #9



Enzyme: [Enolase](#)

Notes - This reaction is a simple dehydration (or α/β elimination) of 2PG to form phosphoenolpyruvate (PEP), but it has the effect of increasing the energy of hydrolysis of the phosphate bond almost four fold (from -15.6 kJ/mol in 2PG to -61.9 kJ/mol in PEP). This high free energy of hydrolysis is necessary for the next step in glycolysis, which is another substrate level phosphorylation of ADP to form ATP.

$$\Delta G^{\circ'} = +1.7 \text{ kJ/mol}$$

[Reaction Picture](#)

Reaction #10



Enzyme: [Pyruvate Kinase](#)

Notes - This reaction is important for several reasons. First, it generates ATP from the substrate-level phosphorylation of ADP, putting the balance for glycolysis at a net gain of two molecules of ATP per molecule of glucose. Second, it is very favorable energetically, serving to "pull" the two preceding reactions (both of which have slightly positive $\Delta G^{\circ'}$ values) forward. Third, the enzyme catalyzing the reaction, pyruvate kinase, is allosterically inactivated by ATP, alanine, and acetyl-CoA, allosterically activated by F1,6BP, and is inactivated by covalent modification (phosphorylation) from the kinase cascade.

$$\Delta G^{\circ'} = -31.4 \text{ kJ/mol}$$

[Reaction Picture](#)

See also: [Gluconeogenesis and Glycolysis Interregulation Link Page](#), [Alanine](#), [Acetyl-CoA](#), [Fructose-2,6-Bisphosphate](#), [AMP](#), [Oxidative Phosphorylation](#) (from Chapter 15)

INTERNET LINKS:

1. [Glycolysis/Gluconeogenesis](#)
-

Geographical Hierarchy		Economic Sector		Energy Source		Infrastructure		Industrial Activity	
Country	Region	Primary	Secondary	Renewable	Fossil	Transport	Utilities	Manufacturing	Services
North America	Canada	Oil	Manufacturing	Hydro	Natural Gas	Air	Power	Automotive	Finance
	USA	Natural Gas	Technology	Solar	Coal	Road	Power	Automotive	Finance
	Mexico	Oil	Manufacturing	Hydro	Natural Gas	Air	Power	Automotive	Finance
South America	Brazil	Soybeans	Iron Ore	Hydro	Natural Gas	Air	Power	Automotive	Finance
	Argentina	Soybeans	Iron Ore	Hydro	Natural Gas	Air	Power	Automotive	Finance
	Colombia	Oil	Manufacturing	Hydro	Natural Gas	Air	Power	Automotive	Finance
Europe	Germany	Automotive	Chemicals	Solar	Coal	Road	Power	Automotive	Finance
	France	Automotive	Chemicals	Nuclear	Natural Gas	Road	Power	Automotive	Finance
	UK	Finance	Technology	Solar	Natural Gas	Road	Power	Automotive	Finance
Asia	China	Manufacturing	Technology	Solar	Coal	Road	Power	Automotive	Finance
	India	Manufacturing	Technology	Solar	Coal	Road	Power	Automotive	Finance
	Japan	Automotive	Chemicals	Solar	Natural Gas	Road	Power	Automotive	Finance
Africa	South Africa	Manufacturing	Technology	Solar	Coal	Road	Power	Automotive	Finance
	Egypt	Manufacturing	Technology	Solar	Natural Gas	Road	Power	Automotive	Finance
	Nigeria	Oil	Manufacturing	Hydro	Natural Gas	Air	Power	Automotive	Finance
Oceania	Australia	Minerals	Manufacturing	Solar	Natural Gas	Road	Power	Automotive	Finance
	New Zealand	Manufacturing	Technology	Hydro	Natural Gas	Road	Power	Automotive	Finance
	Antarctica	Research	Technology	Hydro	Natural Gas	Road	Power	Automotive	Finance

This table provides a comprehensive overview of global economic and energy trends. The data is organized into several key sections:

- Geographical Hierarchy:** Lists countries and their primary regions.
- Economic Sector:** Details the primary and secondary industries for each country.
- Energy Source:** Identifies the main energy sources, including renewable and fossil fuels.
- Infrastructure:** Lists the primary modes of transport and utility services.
- Industrial Activity:** Shows the dominant manufacturing and service sectors.

Country	Region	Primary	Secondary	Renewable	Fossil	Transport	Utilities	Manufacturing	Services
USA	North America	Natural Gas	Technology	Solar	Coal	Road	Power	Automotive	Finance
Germany	Europe	Automotive	Chemicals	Solar	Coal	Road	Power	Automotive	Finance
China	Asia	Manufacturing	Technology	Solar	Coal	Road	Power	Automotive	Finance

Country	Region	Primary	Secondary	Renewable	Fossil	Transport	Utilities	Manufacturing	Services
Brazil	South America	Soybeans	Iron Ore	Hydro	Natural Gas	Air	Power	Automotive	Finance
France	Europe	Automotive	Chemicals	Nuclear	Natural Gas	Road	Power	Automotive	Finance
India	Asia	Manufacturing	Technology	Solar	Coal	Road	Power	Automotive	Finance

Country	Region	Primary	Secondary	Renewable	Fossil	Transport	Utilities	Manufacturing	Services
Australia	Oceania	Minerals	Manufacturing	Solar	Natural Gas	Road	Power	Automotive	Finance
Egypt	Africa	Manufacturing	Technology	Solar	Natural Gas	Road	Power	Automotive	Finance
Japan	Asia	Automotive	Chemicals	Solar	Natural Gas	Road	Power	Automotive	Finance

Country	Region	Primary	Secondary	Renewable	Fossil	Transport	Utilities	Manufacturing	Services
Mexico	North America	Oil	Manufacturing	Hydro	Natural Gas	Air	Power	Automotive	Finance
Argentina	South America	Soybeans	Iron Ore	Hydro	Natural Gas	Air	Power	Automotive	Finance
UK	Europe	Finance	Technology	Solar	Natural Gas	Road	Power	Automotive	Finance
New Zealand	Oceania	Manufacturing	Technology	Hydro	Natural Gas	Road	Power	Automotive	Finance
Nigeria	Africa	Oil	Manufacturing	Hydro	Natural Gas	Air	Power	Automotive	Finance
Antarctica	Oceania	Research	Technology	Hydro	Natural Gas	Road	Power	Automotive	Finance

Hexokinase

Hexokinase catalyzes the ATP-dependent phosphorylation of a broad spectrum of 6-carbon sugars. In the reaction involving glucose and ATP, glucose-6-phosphate (G6P) and ADP are formed.

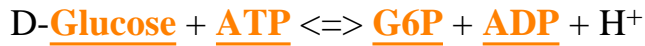

(see). This reaction constitutes the first step of the process of [glycolysis](#) and is energetically favorable ($\Delta G^{\circ\prime} = -16.7 \text{ kJ/mol}$).

Hexokinase requires Mg^{2+} . The enzyme has a low K_M for the sugar substrate (about 0.1 mM).

Hexokinase is inhibited by the product of its reaction, G6P.

Intracellular levels of glucose are usually far higher than the K_M value for **hexokinase**, meaning that the enzyme functions *in vivo* at saturating substrate concentrations. A liver form of the enzyme called [glucokinase](#) has the same substrate specificity, but a significantly higher K_M (about 10mM).

Hexokinase is not involved in the process of [gluconeogenesis](#). Instead, the enzyme [glucose-6-phosphatase](#) catalyzes the hydrolysis of G6P to glucose and P_i , bypassing the large $\Delta G^{\circ\prime}$ of the **hexokinase**-catalyzed reaction.

[Next step](#) of glycolysis

See also: [Enzymes/Energies of Glycolysis](#), [Reaction Picture](#)

INTERNET LINKS:

1. [Rasmol Image of Hexokinase](#) (slow)
 2. [Glycolysis/Gluconeogenesis](#)
-

Glucokinase

Glucokinase is the name given to a special liver form of the enzyme [hexokinase](#). Like hexokinase, **glucokinase** catalyzes the ATP-dependent phosphorylation of [glucose](#) to form glucose-6-phosphate ([G6P](#)) and ADP. This is the first step of glycolysis. The enzyme will act on a variety of 6-carbon sugars, producing moieties phosphorylated at position six. **Glucokinase**, however, has a higher K_M for sugar substrate compared to hexokinase (10 mM vs. 1 mM). This difference is very important for the liver, which is a major source of glucose from gluconeogenesis. The higher K_M for **glucokinase** means that less glucose will be phosphorylated, allowing more glucose to be exported to the bloodstream, where it can be delivered to other tissues that do not make their own glucose. This may be particularly important during exercise, when muscle cells rapidly exhaust their endogenous supply of glucose. This is an essential part of the Cori cycle.

Glucokinase is not involved in the process of [gluconeogenesis](#). Instead, the enzyme glucose-6-phosphatase catalyzes the hydrolysis of G6P to glucose and Pi, bypassing the large $\Delta G^\circ'$ of the **glucokinase**-catalyzed reaction.

[Next step](#) of glycolysis; [Enzymes of glycolysis](#); Glycolysis [overview](#)

See also: [Glucose-6-Phosphatase](#), , [Liver Metabolism](#)

INTERNET LINK: for [RasMol Structure \(slow\)](#)

Unnumbered Item

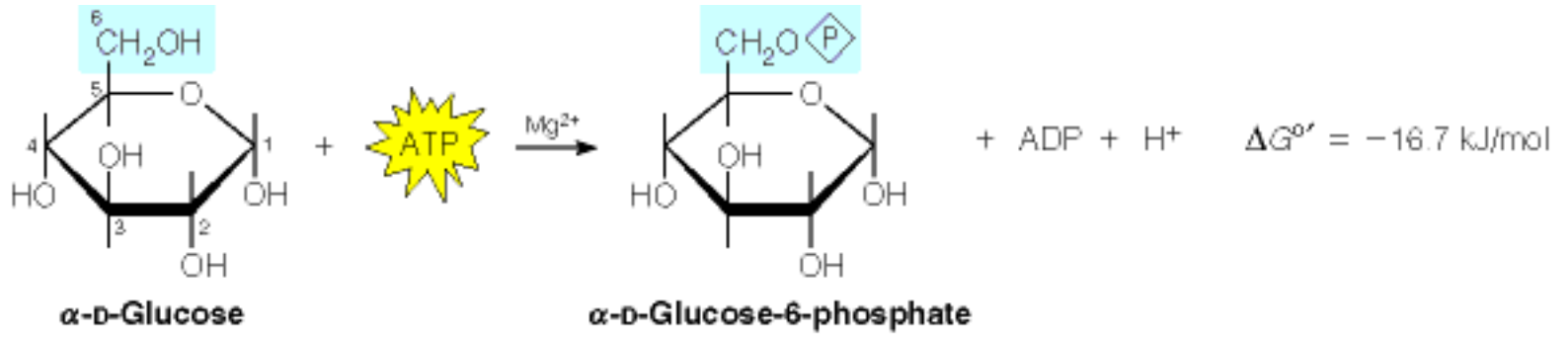

D-Fructose-6-Phosphate (F6P)

F6P is a phosphorylated form of [fructose](#) commonly found in cells. **F6P** is an intermediate in [glycolysis](#), [gluconeogenesis](#), the [pentose phosphate pathway](#), and the [Calvin cycle](#). **F6P** is a substrate in biosynthesis of the important allosteric factor regulating glycolysis, [fructose-2,6-bisphosphate](#) and is also an important precursor of amino sugars (last enzyme below).

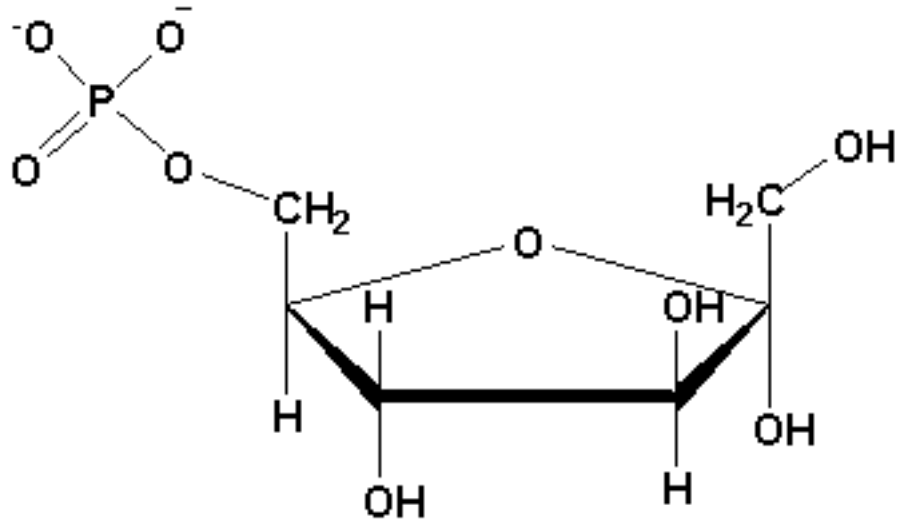

Fructose-6-phosphate (F6P)

Enzymes whose activity includes F6P:

[Phosphoglucoisomerase](#)

[Phosphofructokinase](#)

[Fructose 1,6 Bisphosphatase](#)

[Fructose 2,6 Bisphosphatase](#)

[Transaldolase](#)

[Glutamine:Fructose-6-Phosphate Amidotransferase](#)

See also: [Fructose](#), [Biosynthesis of Amino Sugars](#), [Fructose Metabolism](#), [Glucosamine-6-Phosphate](#)

INTERNET LINK: [Pentose Phosphate Pathway](#)

Fructose

Fructose is a monosaccharide. It contains six carbons and a ketone group, classifying it as a ketohexose. **Fructose** is present as the free sugar in many fruits, and it is also derived from hydrolysis of sucrose (see Figure 13.12).

Fructose is acted on by the enzyme fructokinase to produce fructose-1-phosphate.

Fructose (from sucrose) is also involved in dextran synthesis in bacteria.

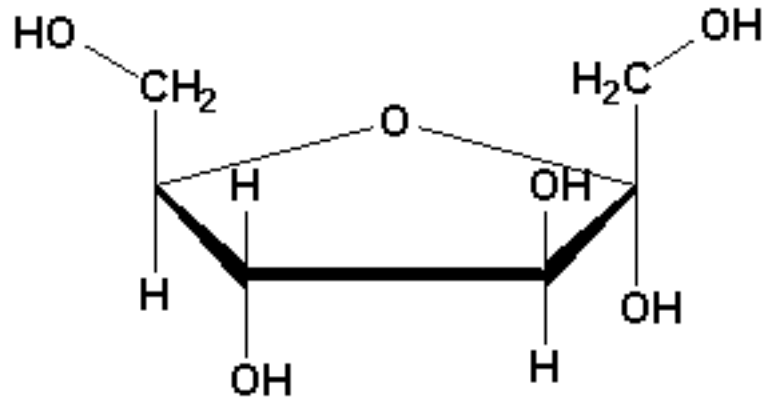

See also: Monosaccharide Nomenclature, Fructose Metabolism, Fructose-1,6-Aldolase B

INTERNET LINK: Fructose and Mannose Metabolism

Sucrose

Sucrose is a disaccharide, composed of a glucose joined through carbon 1 in α linkage to carbon 2 of fructose.

See also: Sucrase, Sucrose Phosphorylase

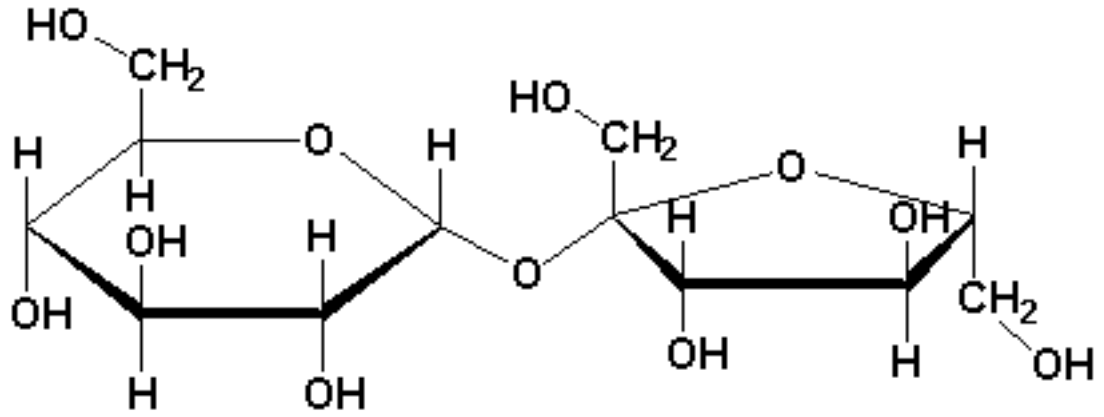

Sucrose

INTERNET LINK: [Starch and Sucrose Metabolism](#)

Sucrase



Sucrase catalyzes the hydrolysis of sucrose to fructose and glucose:



See also: [Sucrose Phosphorylase](#)

INTERNET LINK: [Starch and Sucrose Metabolism](#)

Sucrose Phosphorylase

Sucrose phosphorylase is a bacterial enzyme that catalyzes the phosphorolysis of sucrose to yield glucose-1-phosphate and fructose.



See also: [Sucrase](#), [Phosphorolysis](#)

Glucose-1-Phosphate

Glucose-1-phosphate is an intermediate in glycogen catabolism, glycogen biosynthesis, and galactose metabolism, ([Figure 13.13](#)). **Glucose-1-phosphate** is produced as a result of phosphorolysis of glycogen and as a result of conversion from [glucose-6-phosphate](#) by [phosphoglucomutase](#). **Glucose-1-phosphate** is also an intermediate in galactose metabolism.

See also: [Glycogen](#), [UDP-Glucose](#), [Galactose Metabolism](#), [Glycogen Metabolism Diseases](#)

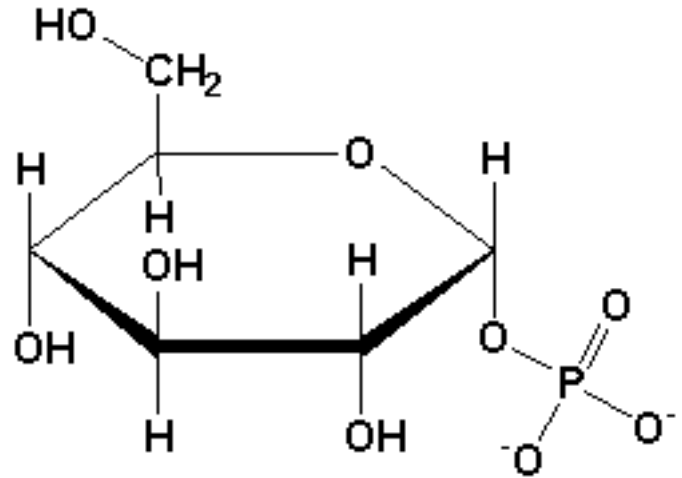

Glucose-1-phosphate

Phosphoglucomutase

(Also called **glucose phosphomutase**) **Phosphoglucomutase** catalyzes the interconversion of glucose-1-phosphate (G1P) and glucose-6-phosphate (G6P).

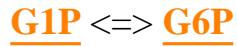

This reaction is important in glycogen biosynthesis and galactose metabolism. The enzyme is composed of two polypeptide chains, labelled A and B.

See also: [Galactose Metabolism](#), [Glycogen Biosynthesis](#)

INTERNET LINKS:

1. [Pathways Using Phosphoglucomutase](#)
 2. [Chain A Structure](#) (slow)
 3. [Chain B Structure](#) (slow)
-

UDP-Glucose

UDP-glucose is an intermediate in the synthesis of **glycogen**, and in **galactose metabolism**.

It is made from UTP and glucose-1-phosphate by action of the enzyme **UDP-glucose pyrophosphorylase**.

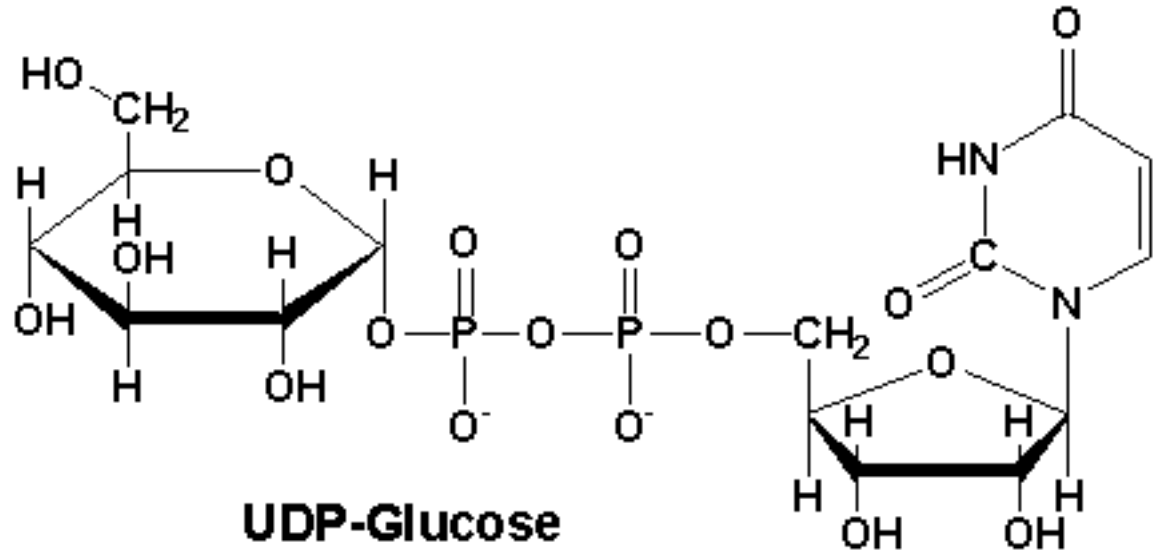

UDP-glucose and **UDG-galactose** can be

interconverted by the enzyme **UDP-galactose-4-epimerase** (**Figure 13.14**).

UDP-glucose can also be made in a reaction catalyzed by UDP-glucose pyrophosphorylase in which glucose-1-phosphate is linked to UTP to form UDP-glucose with splitting out of pyrophosphate (**Figure 13.13**).

UDP-glucose transfers glucose to **dolichol phosphate** to form **dolichol phospho-glucose** in synthesis of N-linked glycoproteins.

UDP-glucose is also an inhibitor of **carbamoyl phosphate synthetase II**, the primary regulatory enzyme in pyrimidine biosynthesis.

See also: **UDP-Galactose 4-Epimerase**, **UTP**, **Glucose-1-Phosphate**, , **Biosynthesis of Glycoconjugates**, **De Novo Pyrimidine Nucleotide Metabolism**, **Biosynthesis of Glycoconjugates**

UDP-Glucose Pyrophosphorylase

UDP-Glucose Pyrophosphorylase catalyzes the synthesis of UDP-glucose and PPi from UTP and glucose-1-phosphate.



UDP-glucose, produced in this reaction is subsequently used by the enzyme glycogen synthase to incorporate glucose into the growing glycogen chain in glycogen synthesis.

See also: [Glycogen Biosynthesis](#), [Glycogen Synthase](#), [Glucose](#), [Glycogen](#)

Uridine Triphosphate (UTP)

UTP is a nucleotide that is a substrate for RNA polymerase in synthesis of RNA. It is also a precursor of CTP in *de novo* synthesis of pyrimidine nucleotides ([Figure 22.10](#))

$\text{UTP} + \text{ATP} + \text{Gln} \rightleftharpoons \text{CTP} + \text{ADP} + \text{Glu} + \text{Pi}$ (catalyzed by [CTP synthetase](#))

UTP is also used to activate sugars for polysaccharide synthesis, such as the reaction below, which activated glucose in glycogen biosynthesis:

$\text{Glucose-1-Phosphate} + \text{UTP} \rightleftharpoons \text{UDP-Glucose} + \text{PPi}$ (catalyzed by [UDP-Glucose Pyrophosphorylase](#))

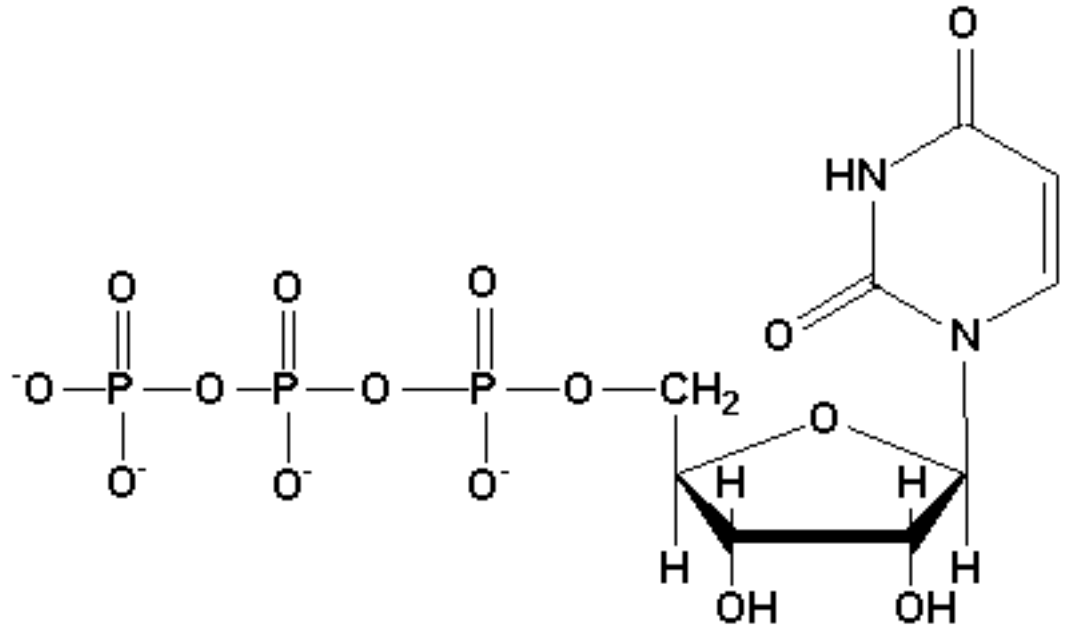

Uridine Triphosphate (UTP)

See also: [Nucleotides](#), [De Novo Pyrimidine Nucleotide Metabolism](#), [Nucleotide Salvage Synthesis](#)

Figure 22.10: *De novo* synthesis of pyrimidine nucleotides.

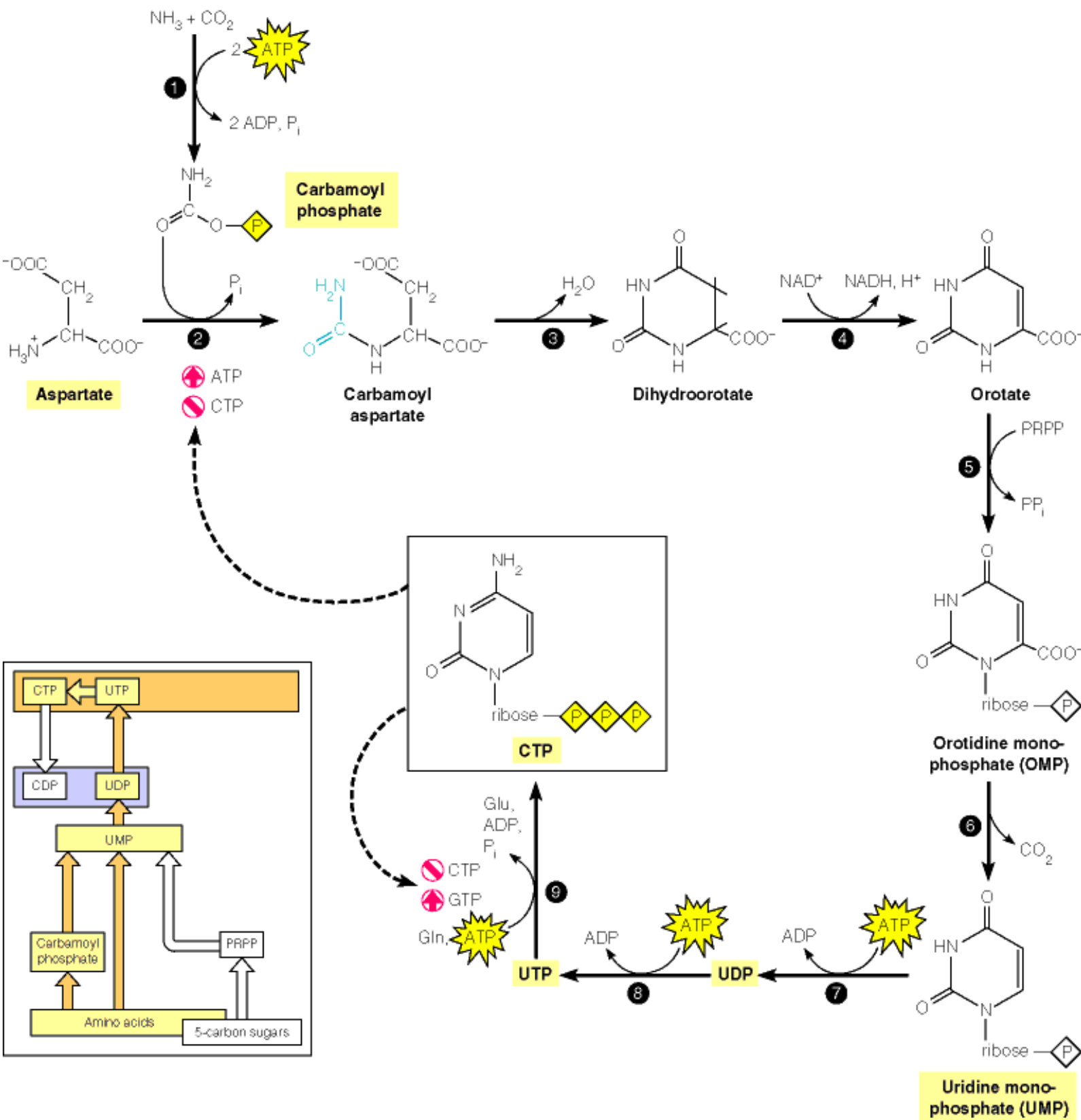

Glutamate Synthase



Glutamate synthase catalyzes the reaction below:



(see [here](#) also)

See also: [Utilization of Ammonia](#), [Citric Acid Cycle Intermediates in Amino Acid Metabolism](#)

Utilization of Ammonia

Virtually all organisms share a few common routes for the utilization of inorganic nitrogen in the form of ammonia. At low levels, ammonia is a central metabolite, but at high levels it is quite toxic. Ammonia is a substrate for five enzymes that convert it to various organic nitrogen compounds.

All organisms assimilate ammonia via reactions leading to glutamate, glutamine, asparagine, and carbamoyl phosphate ([Figure 20.7](#), see below). Most of the nitrogen that finds its way from ammonia to amino acids and other nitrogenous compounds does so via glutamate and glutamine. Thus, the amino nitrogen of glutamate and the amide nitrogen of glutamine are extremely active in biosynthesis.

Glutamate formation - [Glutamate dehydrogenase](#) catalyzes the reductive amination of α -ketoglutarate:

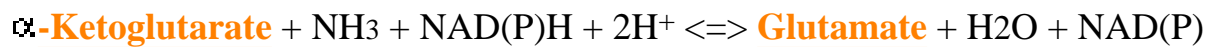

Bacteria growing with ammonia as their sole nitrogen source use this reaction as the primary route for nitrogen assimilation. In animal cells, the reversible reaction can function in either direction. The enzyme is allosterically regulated. ATP or GTP inhibits its action. [Glutamate synthase](#) catalyzes a similar reaction:



Glutamate synthase probably plays a larger role in glutamate synthesis in most cells than glutamate dehydrogenase, due to the high K_M of the glutamate dehydrogenase for NH_3 .

Glutamine formation - [Glutamine synthetase](#) catalyzes the following reaction:



The *E. coli* glutamine synthetase is a dodecamer, with 12 identical subunits and the complex has a molecular weight of about 600,000 Daltons. The amide nitrogen of glutamate is used for the synthesis of several amino acids, purine and pyrimidine nucleotides, and amino sugars, so glutamine synthetase plays a central role in nitrogen metabolism. In animals, the enzyme is a key participant in detoxifying ammonia, particularly in the brain, and in ammonia excretion in the kidney. Accumulation of glutamate and glutamine depletes α -ketoglutarate, which would interfere with the [citric acid cycle](#). As a result, glutamine synthetase is tightly regulated. Mechanisms include the following:

Cumulative feedback Inhibition - Eight specific feedback inhibitors, which are either metabolic end products of glutamine (tryptophan, histidine, glucosamine-6-phosphate, carbamoyl phosphate, CTP, or AMP) or indicators of the general status of amino acid metabolism (alanine or glycine), can bind to any of the subunits of the enzyme and at least partially inhibit it. The more inhibitors that bind, the greater the inhibition.

Covalent modification (adenylylation) - A specific tyrosine residue in glutamine synthetase can react with ATP to form a phosphate ester with AMP (see [here](#)). Adenylylation renders the catalytic site of the enzyme inactive. Adenylylation and deadenylylation involve a complex series of regulatory cascades. [Figure 20.9](#) shows regulatory mechanisms of the *E. coli* enzyme. Both processes are catalyzed by the same enzyme—a complex of adenylyl transferase (AT) and a regulatory protein, PII. The form of PII determines whether the AT-PII complex catalyzes adenylylation or deadenylylation. If PII is uridylylated, the AT-PII complex catalyzes deadenylylation. Deuridylylation of PII causes the AT-PII complex to catalyze adenylylation. The enzyme uridylyl transferase catalyzes uridylylation of PII, whereas deuridylylation is catalyzed by a different enzyme. Uridylyl transferase is allosterically regulated, with ATP and α -ketoglutarate activating it and glutamine inhibits it.

Asparagine formation - Asparagine synthetase catalyzes the conversion of aspartate to asparagine as follows:



Note that asparagine synthetase cleaves ATP to yield AMP + PPi, whereas glutamine synthetase yields ADP + Pi. Glutamine (Gln) is a preferred substrate over ammonia.

Carbamoyl phosphate formation - Carbamoyl Phosphate Synthetase catalyzes the formation of carbamoyl phosphate in the following two reactions (glutamine is the preferred substrate):

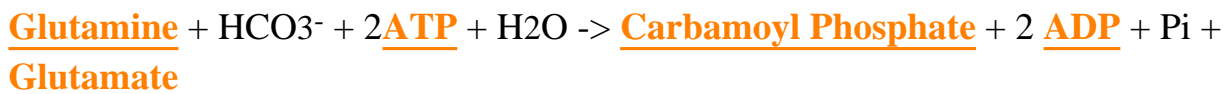

A bacterial reaction catalyzes both reactions. In eukaryotes, two forms of the enzyme (one

in mitochondria and one in cytoplasm) are found. The enzyme is inhibited by **UTP**, consistent with the involvement of carbamoyl phosphate in pyrimidine nucleotide synthesis.

See also: [Metabolic Nitrogen Balance](#), [Transamination in Amino Acid Metabolism](#), [Amino Acid Degradation](#), [Urea Cycle](#), [Ammonia Transport in the Body](#), [De Novo Pyrimidine Nucleotide Metabolism](#) (from Chapter 22).

INTERNET LINK: [Glutamine Synthetase](#)

Figure 20.7: Reactions in assimilation of ammonia and major fates of the fixed nitrogen.

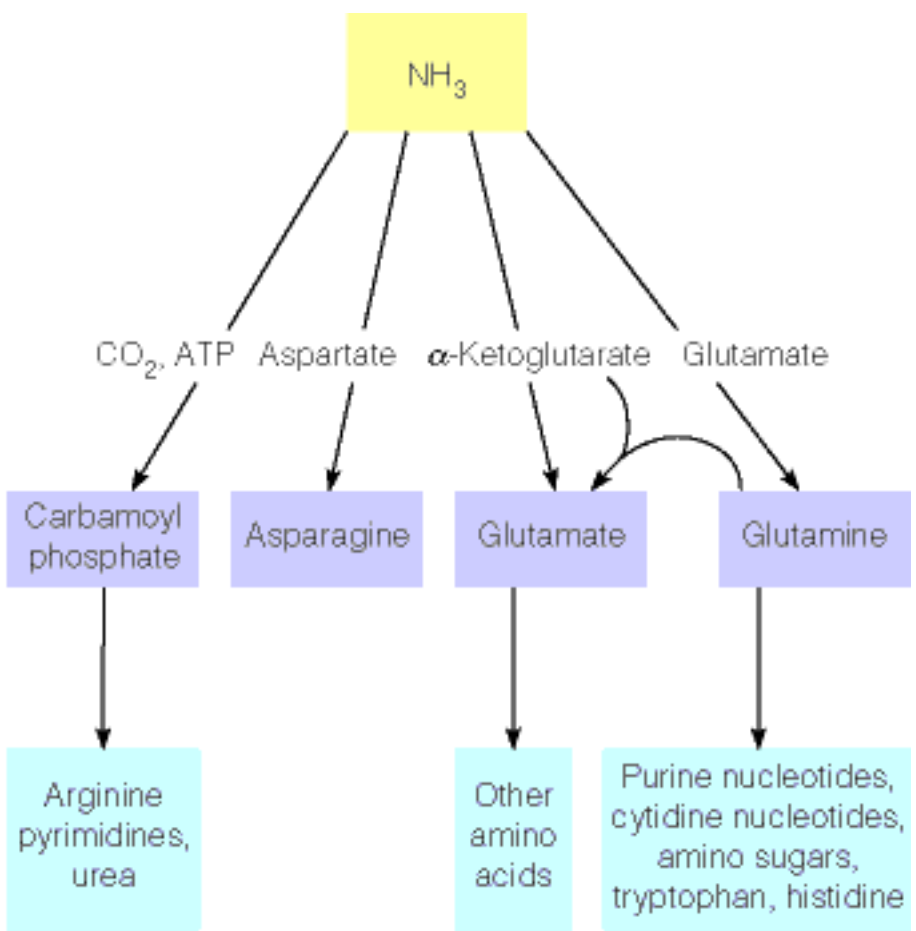

Glutamate Dehydrogenase

Glutamate dehydrogenase catalyzes the anaplerotic reaction below (see [here](#) also):

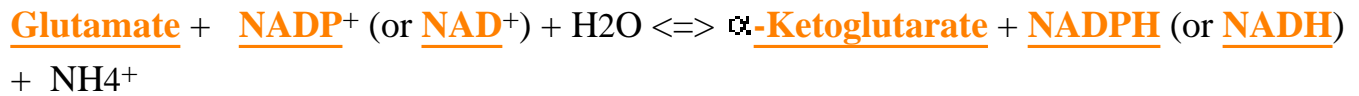

Bacteria growing with ammonia as their sole nitrogen source use this reaction as the primary route for nitrogen assimilation. In animal cells, the reversible reaction can function in either direction. The enzyme is allosterically regulated. ATP or GTP inhibits its action.

See also: [Anaplerotic Reactions](#), [Utilization of Ammonia](#)

INTERNET LINK: [Urea Cycle and Metabolism of Amino Groups](#)

Anaplerotic Pathways

Intermediates in the citric acid cycle are involved in many other metabolic pathways of the cell, including amino acid metabolism (see below), [gluconeogenesis](#), and fatty acid metabolism (see [here](#) and [here](#)). Thus, the amounts of citric acid cycle intermediates will vary according to the metabolic needs of the cell. Replacement of citric acid cycle intermediates occurs via **anaplerotic pathways**. These pathways function in most cells to keep intramitochondrial concentration of citric acid cycle intermediates fairly constant with time. [Figure 14.18](#) depicts several **anaplerotic pathways** and these are summarized below:

[Oxaloacetate](#) - from transamination of [aspartate](#), [phosphoenolpyruvate \(PEP carboxylase\)](#), and [pyruvate \(pyruvate carboxylase\)](#).

[Malate](#) - from pyruvate ([malic enzyme](#))

α-[Ketoglutarate](#) - from transamination of [glutamate](#)

Note that because the citric acid cycle is cyclic, increasing the concentration of one of the intermediates (such as oxaloacetate) has the ultimate effect of increasing the concentration of the other intermediates in the cycle as well.

See also: [Citric Acid Cycle Strategy](#), [Citric Acid Cycle Intermediates in Amino Acid Metabolism](#)

β - Oxidation of Saturated Fatty Acids

Inside of the **mitochondrion**, fatty acyl-CoAs are **oxidized** in a series of steps that each release a two-carbon fragment, in the form of acetyl-CoA. Each step involves four reactions-dehydrogenation, hydration, dehydrogenation, and thiolytic cleavage (**Figure 18.16**). The individual reactions are summarized as follows:

1. **Fatty acyl-CoA** + E-**FAD** \rightleftharpoons **Trans- Δ^2 -Enoyl-CoA** + E-**FADH₂** (catalyzed by **Fatty Acyl-CoA Dehydrogenase**)(**Figure 18.16**). The FAD and FADH₂ in the reaction are enzyme-bound. Electrons from FADH₂ are donated to coenzyme Q in the electron transport system (**Figure 18.17**).
2. **Trans- Δ^2 -Enoyl-CoA** + H₂O \rightleftharpoons **L-3-Hydroxyacyl-CoA** (catalyzed by **Enoyl-CoA Hydratase**)(**Figure 18.16**).
3. **L-3-Hydroxyacyl-CoA** + **NAD⁺** \rightleftharpoons **3-Ketoacyl-CoA** + **NADH** + H⁺ (catalyzed by **3-Hydroxyacyl-CoA Dehydrogenase**)(**Figure 18.16**).
4. **3-Ketoacyl-S-CoA** + **CoASH** \rightleftharpoons **Acyl-CoA** + **Acetyl-CoA** (catalyzed by **β -Ketothiolase**)(**Figure 18.16**).

A modified form of **β -oxidation of saturated fatty acids** occurs in peroxisomes, organelles that are present in most eukaryotic cells.

See also: [Unsaturated Fatty Acid Oxidation](#), [Oxidation of Odd-Numbered Fatty Acids](#), [Electron Transport](#), [Peroxisomal \$\beta\$ -Oxidation](#), [Fatty Acids](#)

INTERNET LINK: [Fatty Acid Metabolism](#)

Mitochondria

Mitochondria (singular = **mitochondrion**) are the so-called "power plants" of eukaryotic cells because they are the major source of energy for these cells under aerobic conditions (when oxygen is present). **Mitochondria** are the sites where complex processes involved in energy generation (such as **electron transport** and **oxidative phosphorylation**) are found. The product of **mitochondrial** action is chemical energy stored in the form of adenosine triphosphate, more commonly called **ATP**.

See also: **Figure 1.13**

Oxidative Phosphorylation

Oxidative phosphorylation is a process where the energy of biological oxidation is ultimately converted to the chemical energy of **ATP**.

Movement of electrons through the **electron transport** system (ETS) causes protons to be pumped from the mitochondrial matrix of a eukaryotic cell to the intermembrane space. The difference in potential created by movement of the charged protons as well as the concentration gradient created by the pumping provides the energy source for making ATP in the mitochondrion. This process is called **oxidative phosphorylation**. It occurs as a result of protons moving through Complex V (**Figure 15.2b** and **Figure 15.15**). An analogy for ETS and **oxidative phosphorylation** can be made to a water pumping system, which can pump water to a holding tank on a hill. When needed, the water can be released from the holding tank and be pulled by gravity down the hill. On the way down, the water can turn a turbine and generate electricity. Similarly, the ETS pumps protons out of the mitochondrial matrix to the intermembrane space. When needed, protons flow back through Complex V and turn molecular turbines (**Figure 15.19**) to make ATP.

The efficiency of **oxidative phosphorylation** is determined by the P/O ratio, which is a measure of the amount of ATP made versus the amount of oxygen consumed. Remember that the ETS donates electrons to oxygen in the last step of the process.

The chemiosmotic coupling mechanism explains how ATP is synthesized by mitochondria as a result of protons pumped during ETS. There is a considerable amount of evidence in support of this model.

The actual site in the mitochondrion where ATP is made is Complex V (also called ATP synthase or the **F₀F₁ complex**). It is located on the inner mitochondrial cristae and has the structure shown in **Figure 15.14**.

See also: [Electron Transport](#), [P/O Ratio](#), [Chemiosmotic Coupling](#), [Integrity of Mitochondrial Membranes](#), [Uncoupling ETS and Oxidative Phosphorylation](#), [The F₁F₀ Complex](#), [Oxidation as a Metabolic Energy Source](#) (from Chapter 12)

INTERNET LINK: [Oxidative Phosphorylation](#)

Figure 15.2: Localization of respiratory processes in the mitochondrion.

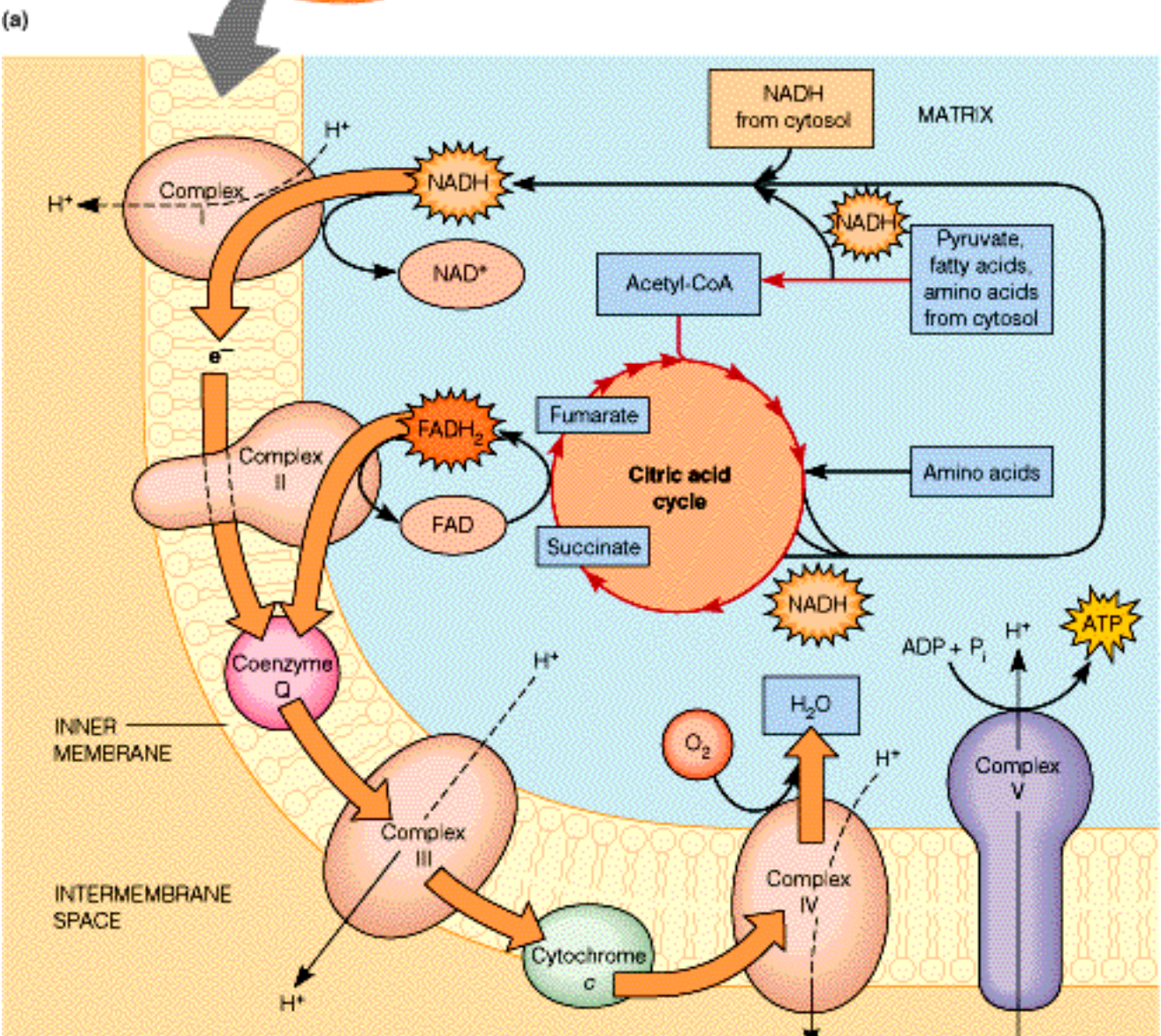
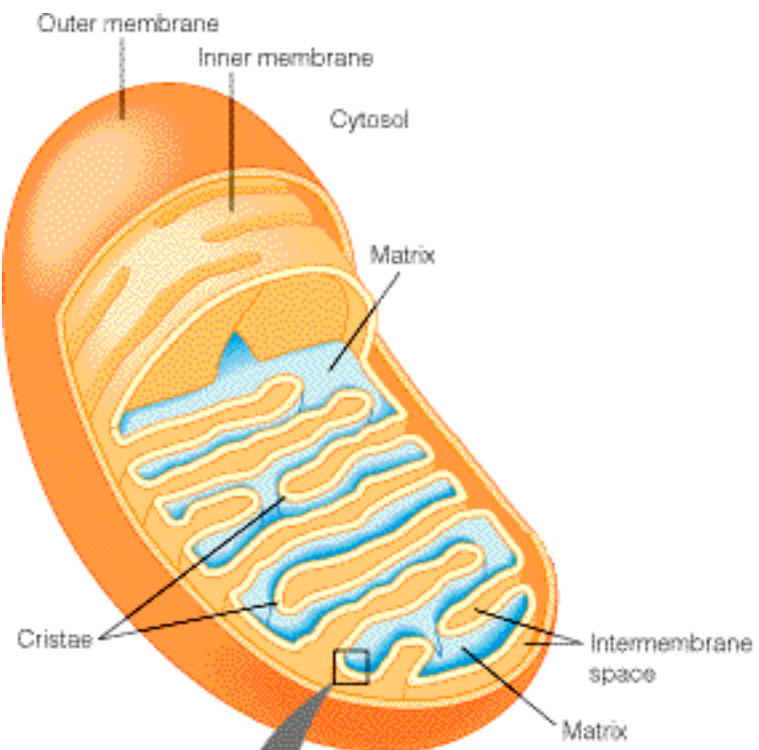

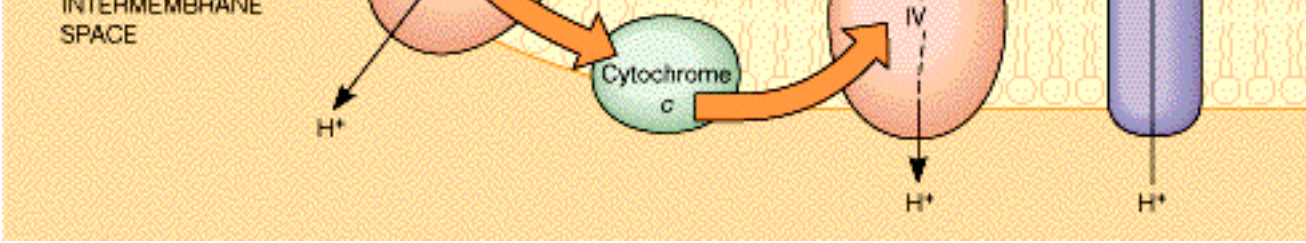

Figure 15.15: Vectorial transport of protons by complexes of the respiratory chain.

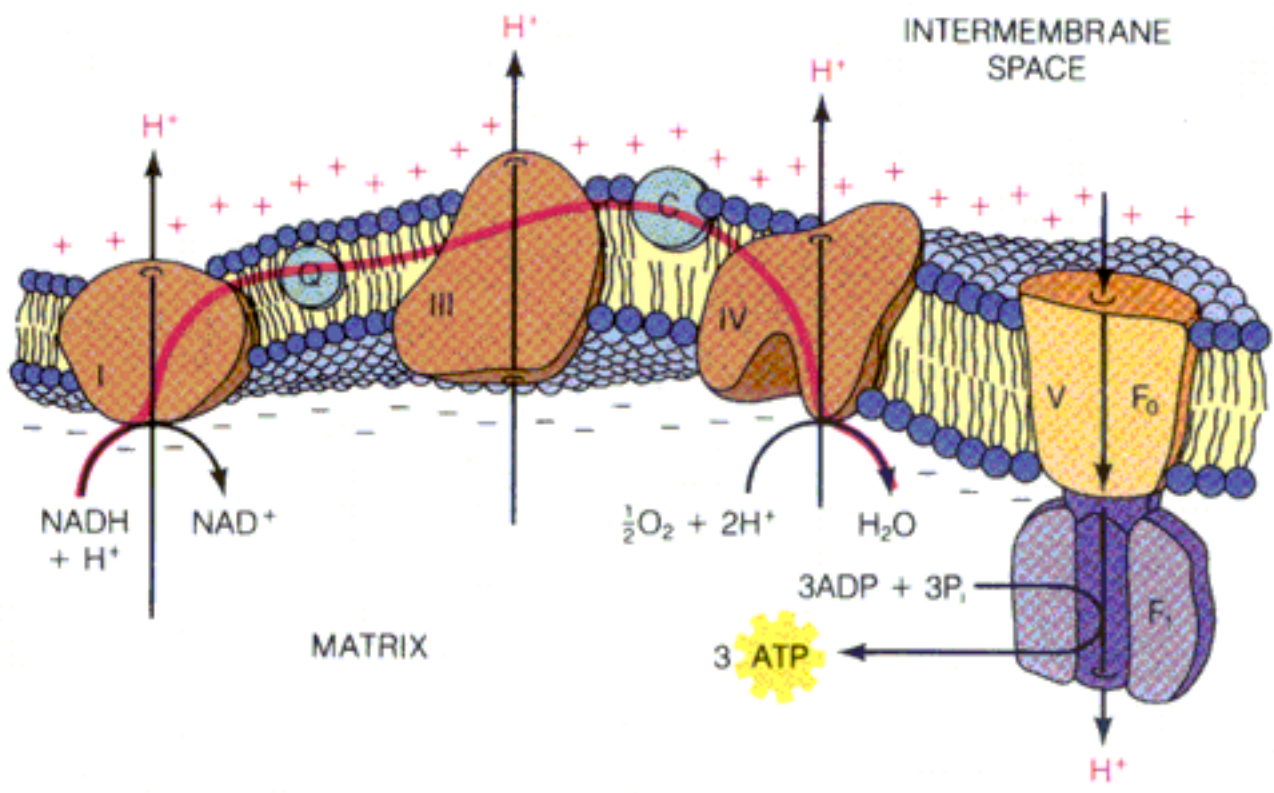
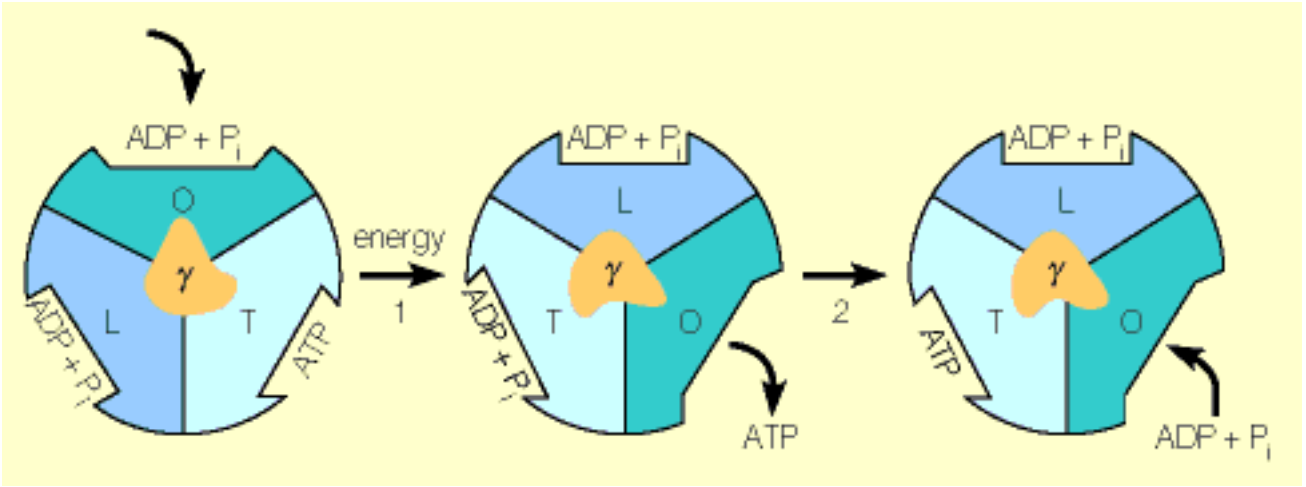

Figure 15.19: F1 ATP synthase as a rotary engine driving the synthesis of ATP.



From Y. Zhou, T. M. Duncan, and R. L. Cross, Proc. Natl. Acad. Sci. USA (1997) 94:10583. Reprinted with permission of the PNAS.

The F₀F₁ Complex

Complex V (also called **ATP synthase** or the **F₀F₁ complex**) is a multi-protein structure with three-fold symmetry, resembling a mushroom ([Figure 15.14](#)). It consists of a top knob called **F₁** and a stalk, which joins the knob to the base called **F₀** in the inner mitochondrial membrane. The **F₁** knob projects into the mitochondrial matrix and contains three $\alpha\beta$ dimers arranged like segments of an orange around the stalk. The stalk contains γ and ϵ proteins; δ is attached to protein b of the **F₀** base, which also contains proteins a and c plus others. The $\alpha\beta\gamma\delta\epsilon abc$ complex is called a stator.

The **F₁ complex** is the part of **complex V** that synthesizes ATP as protons pass from the intermembrane space through the stalk and out the top of the **F₁ complex** into the mitochondrial matrix. Movement of the protons through the **F₁ complex** causes it to rotate ([Figure 15.20](#)). As seen in [Figure 15.19](#), **F₁** contains three similar, but not identical, binding sites for ATP or ADP + Pi. These are called L, T, and O, for Loose, Tight, and Open. The tight binding site always contains ATP. ADP and Pi can bind together in the L site. A turn of the rotor (as a result of proton movement through the complex) converts all three binding sites into new conformations. The T site becomes the O site, and ATP is released. The L site becomes a T site, which starts to condense ADP + Pi to ATP. The O site becomes an L site, which prepares to bind the next ADP + Pi. At each turn of the wheel, an ATP is released.

The antibiotic oligomycin binds to a specific protein of the **F₀ complex**, blocks the flow of protons through the **F₀** channel, and inhibits oxidative phosphorylation directly.

See also: [Chemiosmotic Coupling](#), [Oxidative Phosphorylation](#)

Figure 15.14: Structure of the F₀F₁ complex.

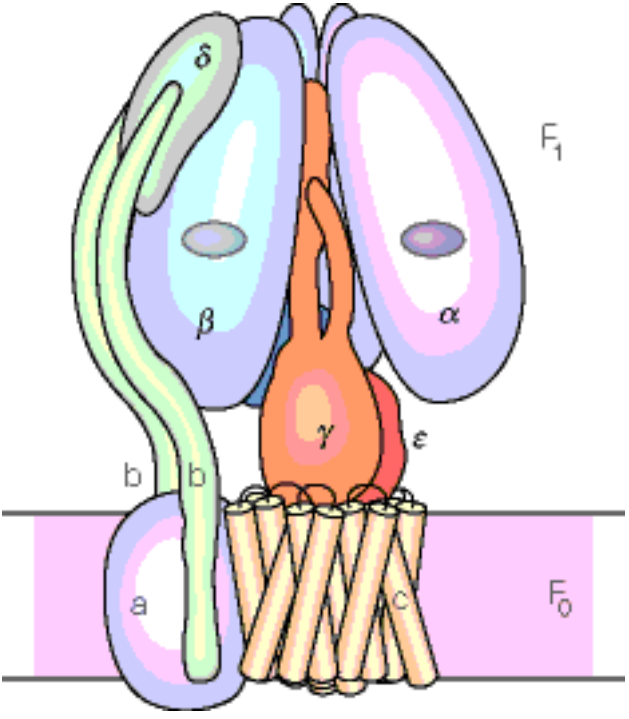

Reprinted with permission from W. Junge, H. Lill, and S. Engelbrecht, Trends Biochem. Sci. (1997) 22:420. © 1997 with permission of Elsevier Science.

Figure 15.20: The experimental system that permits observation of rotation in the F₁ component of F₀F₁ ATP synthase.

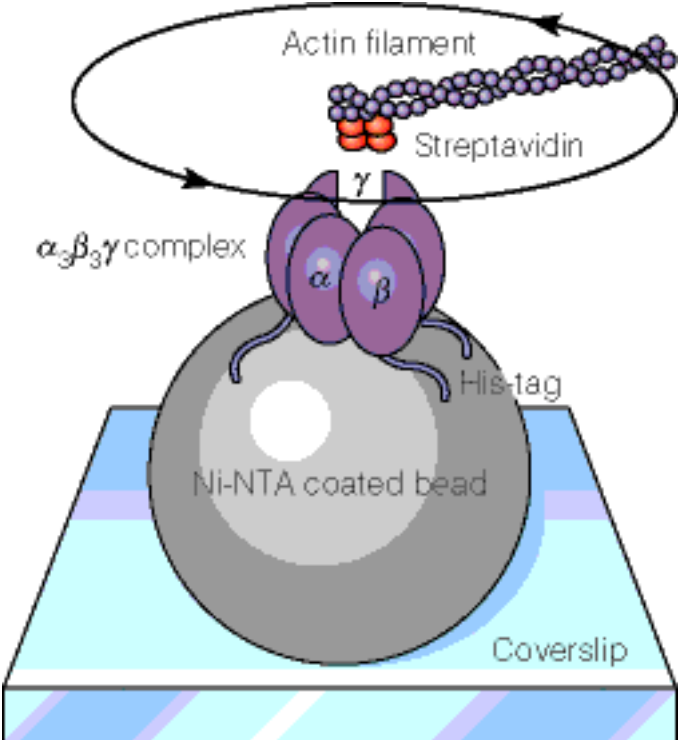

Reprinted with permission from R. Yasuda et al., Cell (1998) 93:1118.

Chemiosmotic Coupling

In 1961, Peter Mitchell proposed the now widely accepted **chemiosmotic coupling** hypothesis to explain **ATP** synthesis as a result of **electron transport** (ETS) and **oxidative phosphorylation**. It consists of the following principles:

1. Energy from electron transport drives an active transport system.
2. The active transport system pumps protons out of the mitochondrial matrix into the intermembrane space.
3. An electrochemical gradient of protons is created, with a lower pH value outside the inner mitochondrial membrane than inside. The protons on the outside have a thermodynamic tendency to flow back in, so as to equalize pH on both sides of the membrane.
4. When protons do flow back into the matrix, the free energy arising from the gradient (21 kJ/mol of protons) is dissipated, with some of it being used to drive the synthesis of ATP.

Evidence supporting the **chemiosmotic coupling hypothesis**:

1. Mitochondria do pump protons and establish a pH gradient across their inner membrane.
2. Oxidative phosphorylation requires an intact inner membrane. If the inner membrane is damaged, protons can leak back into the mitochondrial matrix and destroy the proton gradient. Thus, there would be no energy to make ATP.
3. Key electron transport proteins span the inner membrane. Thus, they are perfectly positioned to serve as pumps.
4. Agents that uncouple ETS from oxidative phosphorylation dissipate the proton gradient.
5. If one creates an artificial proton gradient across the mitochondrial inner membrane by incubating mitochondria in an acid solution, ATP is produced by the mitochondria in the absence of electron transport.

See also: [Integrity of Mitochondrial Membranes](#), [Uncoupling ETS and Oxidative Phosphorylation](#), [Figure 15.15](#)

Integrity of Mitochondrial Membranes

The **integrity of the mitochondrial inner membrane** is essential for oxidative phosphorylation to be coupled to electron transport. According to the chemiosmotic coupling mechanism, the **inner mitochondrial membrane** provides a barrier to the movement of protons. Movement of electrons through the electron transport system causes protons to be pumped from the mitochondrial matrix to the intermembrane space between the **inner and outer mitochondrial membrane**. The electrochemical gradient created by the pumping is a source of potential energy used by **oxidative phosphorylation** to synthesize **ATP** from **ADP** + Pi (**Figure 15.15**).

If the **inner mitochondrial membrane** is damaged such that it no longer provides a barrier to the movement of protons, then the proton electrochemical gradient is destroyed and oxidative phosphorylation will not occur. Uncoupling agents, such as **2,4-dinitrophenol**, which permeabilize the inner mitochondrial membrane to protons, also inhibits oxidative phosphorylation for the same reason.

Maintenance of respiratory control depends on the **structural integrity of the mitochondrion**. Disruption of the organelle causes electron transport to become uncoupled from ATP synthesis. Under these conditions, oxygen uptake proceeds at high rates under all conditions. ATP synthesis is inhibited, even though electrons are being passed along the respiratory chain and used to reduce O₂ to water.

See also: [Chemiosmotic Coupling](#), [Oxidative Phosphorylation](#), [Uncoupling ETS and Oxidative Phosphorylation](#), [Respiratory Control](#)

2,4-Dinitrophenol (DNP)

DNP is a chemical uncoupler of electron transport and oxidative phosphorylation.

DNP permeabilizes the inner mitochondrial membrane to protons, destroying the proton gradient and, in doing so, uncouples the electron transport system from the oxidative phosphorylation. In this situation, electrons continue to pass through the electron transport system and reduce oxygen to water, but **ATP** is not synthesized in the process. The compound, trifluorocarbonyl cyanide phenylhydrazone (**FCCP**), is also an uncoupler.

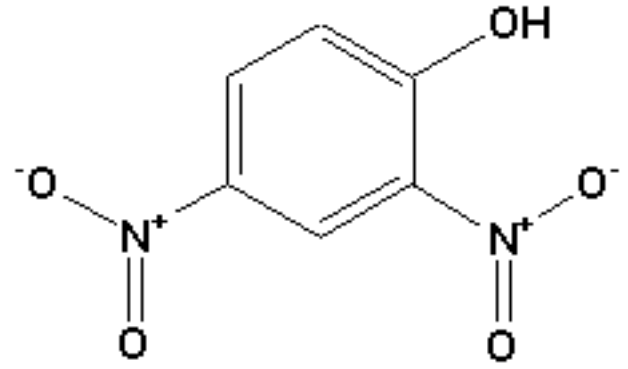

2,4-dinitrophenol (DNP)

The phenolic group of **DNP** is usually dissociated at intracellular pH. However, a **DNP** molecule that approaches the inner mitochondrial membrane from the outside becomes protonated (because the pH is lower there). Protonation increases the hydrophobicity of **DNP**, allowing it to diffuse into the membrane and, by mass action, to pass through. Once inside, the higher pH of the matrix deprotonates the phenolic hydroxyl again. Thus, **DNP** has the effect of transporting H^+ back into the matrix, bypassing the F_0 proton channel and thereby preventing ATP synthesis.

See also: [Uncoupling ETS and Oxidative Phosphorylation](#), [The \$F_0F_1\$ Complex](#), [Integrity of Mitochondrial Membranes](#), [Chemiosmotic Coupling](#)

Trifluorocarbonylcyanide Phenylhydrazine (FCCP)

FCCP is a chemical **uncoupler** of **electron transport** and **oxidative phosphorylation**.

FCCP permeabilizes the inner mitochondrial membrane to protons, destroying the proton gradient and, in doing so, uncouples the electron transport system from the oxidative phosphorylation system. In this situation, electrons continue to pass through the electron transport system and reduce oxygen to water, but ATP is not synthesized in the process. **FCCP** acts similar to 2,4-dinitrophenol (**DNP**) in uncoupling electron transport and oxidative phosphorylation.

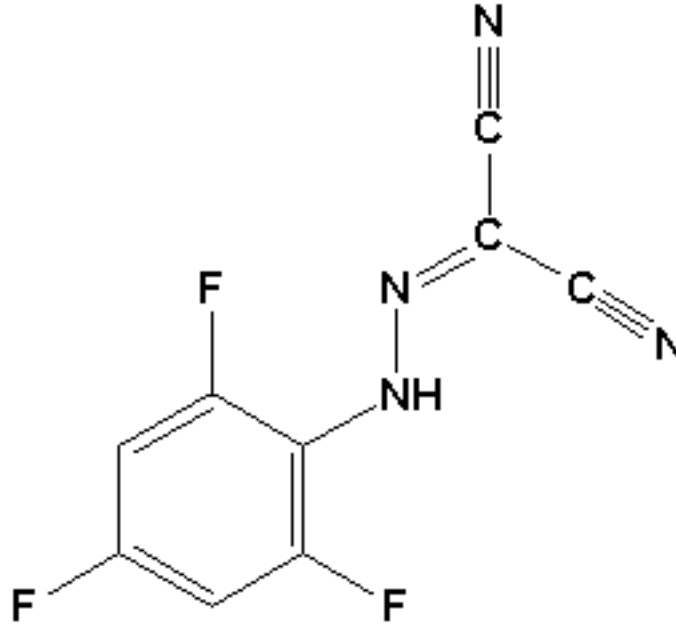

Trifluorocarbonylcyanide phenylhydrazine

See also: [Uncoupling ETS and Oxidative Phosphorylation](#), [The F0F1 Complex](#), [Integrity of Mitochondrial Membranes](#), [Chemiosmotic Coupling](#)

Uncoupling ETS and Oxidative Phosphorylation

2,4-dinitrophenol (**DNP**) and trifluorocarbonyl cyanide phenylhydrazone (**FCCP**) exemplify a class of compounds called **uncoupling agents**. They are so named because they permeabilize the inner mitochondrial membrane to protons, destroying the proton gradient and, in doing so, **uncouple** the **electron transport** system from the **oxidative phosphorylation** system. That is, electrons continue to pass through the electron transport system and reduce oxygen to water, but ATP is not synthesized in the process.

In the case of DNP, the phenolic group is usually dissociated at intracellular pH. However, a DNP molecule that approaches the inner mitochondrial membrane from the outside becomes protonated (because the pH is lower there). Protonation increases the hydrophobicity of DNP, allowing it to diffuse into the membrane and, by mass action, to pass through. Once inside, the higher pH of the matrix deprotonates the phenolic hydroxyl again. Thus, DNP has the effect of transporting H^+ back into the matrix, bypassing the F_0 proton channel and thereby preventing **ATP** synthesis.

See also: [The \$F_0F_1\$ Complex](#), [Integrity of Mitochondrial Membranes](#), [Chemiosmotic Coupling](#)

Respiratory Control

Oxidative phosphorylation can occur only in the presence of adequate supplies of its substrates. It is controlled not by allosteric mechanisms, but simply by substrate availability. Those substrates include **ADP**, Pi, O₂, and an oxidizable metabolite that can generate reduced electron carriers - **NADH** and/or **FADH₂**. Under different metabolic conditions any one of these four substrates can limit the rate of oxidative phosphorylation.

The dependence of oxidative phosphorylation on ADP reveals an important general feature of this process: **Respiration** is tightly coupled to the synthesis of **ATP**. Not only is ATP synthesis absolutely dependent on continued electron flow from substrates to oxygen, but electron flow in normal mitochondria occurs only when ATP is being synthesized as well. This regulatory phenomenon, called **respiratory control**, makes biological sense, because it ensures that substrates will not be oxidized wastefully. Instead, their utilization is controlled by the physiological need for ATP.

In most aerobic cells the level of ATP exceeds that of ADP by 4- to 10-fold. **Respiration** depends on ADP as a substrate for phosphorylation. When ATP is consumed at high rates, accumulation of ADP stimulates respiration, with concomitant activation of ATP resynthesis. Conversely, in a relaxed and well-nourished cell, ATP accumulates at the expense of ADP, and the depletion of ADP limits the rate of both electron transport and its own phosphorylation to ATP. Thus, the energy-generating capacity of the cell is closely attuned to its energy demands.

Experimentally, **respiratory control** is demonstrated by following oxygen utilization in isolated mitochondria (**Figure 15.22**). In the absence of added substrate or ADP, oxygen uptake, caused by oxidation of endogenous substrates, is slow. Addition of an oxidizable substrate, such as glutamate or malate, has but a small effect on the respiration rate. If ADP is then added, however, oxygen uptake proceeds at an enhanced rate until all of the added ADP has been converted to ATP, and then oxygen uptake returns to the basal rate. This stimulation of **respiration** is stoichiometric; that is, addition of twice as much ADP causes twice the amount of oxygen uptake at the enhanced rate. If excess ADP is present instead of oxidizable substrate, the addition of substrate in limiting amounts will stimulate oxygen uptake until the substrate is exhausted.

Maintenance of **respiratory control** depends on the structural integrity of the mitochondrion. Disruption of the organelle causes electron transport to become uncoupled from ATP synthesis. Under these conditions, oxygen uptake proceeds at high rates even in the absence of added ADP. ATP synthesis is inhibited, even though electrons are being passed along the respiratory chain and used to reduce O₂ to water.

Uncoupling of respiration from phosphorylation can also be achieved chemically. Chemical uncouplers such as **DNP** or **FCCP** act by dissipating the proton gradient. Addition of an uncoupler to mitochondria stimulates oxygen utilization even in the absence of added ADP. No phosphorylation occurs under these

conditions because there is no ADP to be phosphorylated.

See also: [P/O Ratio](#), [Chemiosmotic Coupling](#), [Uncoupling ETS and Oxidative Phosphorylation](#), [Integrity of Mitochondrial Membranes](#)

Flavin Adenine Dinucleotide, Reduced (FADH₂)

FADH₂ is an important carrier of electrons.

FAD is the oxidized form of the molecule (lacks electrons).

FADH₂ is the reduced form (carries electrons). FAD and **FADH₂** function in many oxidation reactions, such as those catalyzed by **succinate**

dehydrogenase and **fatty acyl-CoA dehydrogenase**.

Electrons carried by **FADH₂** do not pass through complex I of the mitochondrial **electron transport** system and thus do not result in synthesis of as many **ATPs** in

oxidative phosphorylation as

electrons from **NADH**, which do pass through Complex I. It is estimated that each pair of electrons donated by **FADH₂** results in two ATPs, whereas each pair of electrons from NADH results in three ATPs.

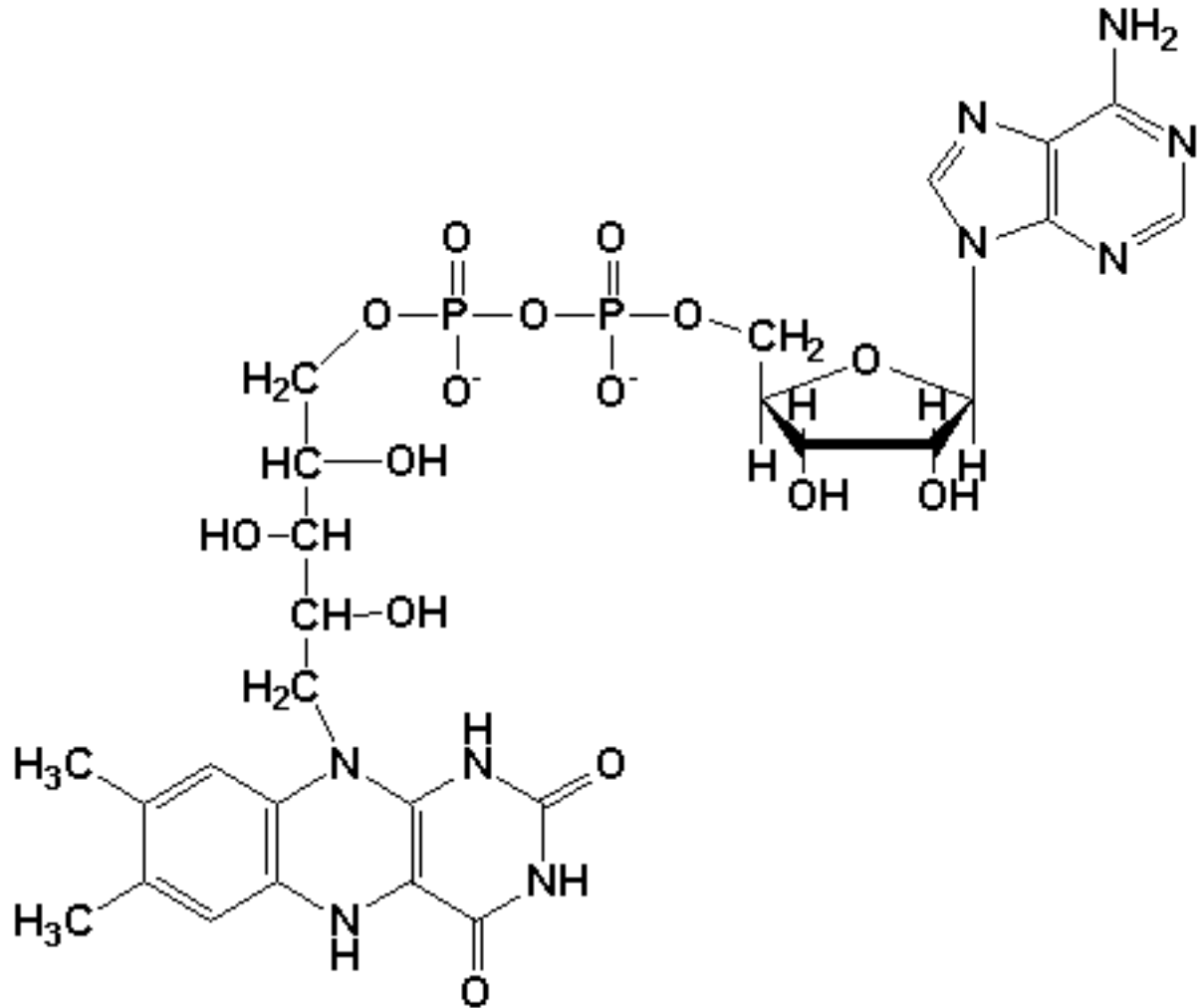

**Flavin Adenine Dinucleotide
Reduced**

See also: [NAD⁺FMN](#), [FMNH₂](#), [Citric Acid Cycle](#)

Flavin Adenine Dinucleotide (FAD)

FAD is an important acceptor of electrons. **FAD** is the oxidized form of the molecule (lacks electrons).

FADH₂ is the reduced form (carries electrons).

FAD and **FADH₂** function in many oxidation reactions, such as those catalyzed by

succinate dehydrogenase and **fatty acyl-CoA**

dehydrogenase. Electrons carried by **FADH₂** do not pass through complex I of the mitochondrial **electron transport** system and thus do not result in synthesis of as many **ATPs** in **oxidative phosphorylation** as electrons from **NADH**, which do pass through Complex I. It is estimated that each pair of electrons donated by **FADH₂** results in two ATPs, whereas each pair of electrons from **NADH** results in three ATPs.

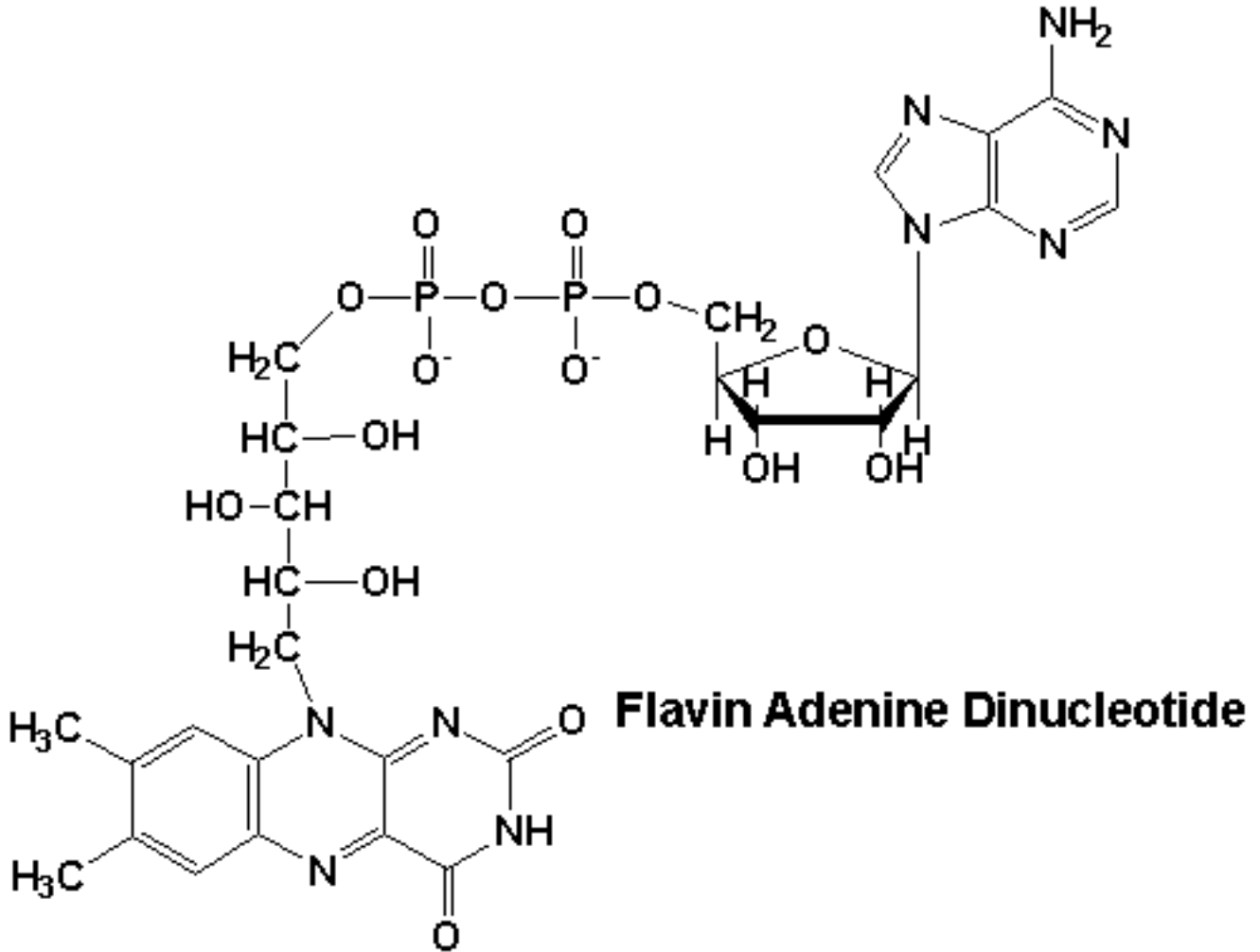

See also: **NAD⁺FMN**, **FMNH₂**, **Citric Acid Cycle**

Fatty Acyl-CoA Dehydrogenase

Fatty acyl-CoA dehydrogenase catalyzes the initial step in the process of β oxidation of fatty acids.



The FAD and FADH₂ in the reaction are enzyme-bound. Electrons from FADH₂ are donated to coenzyme Q in the electron transport system (Figure 18.17).

See also: β -Oxidation of Saturated Fatty Acid, Unsaturated Fatty Acid Oxidation, Oxidation of Odd-Numbered Fatty Acids, Peroxisomal β -Oxidation, Fatty Acids

INTERNET LINK: Fatty Acid Metabolism

Acyl-CoA

Acyl-CoA refers to a fatty acid chain linked to coenzyme A via a thioester bond.

Acyl-CoAs are intermediates in oxidation of fatty acids, in fat synthesis, in elongation of fatty acids longer than palmitate (16 carbons), in fatty acid desaturation.

Enzymes that act on **acyl-CoAs** include thiolase, fatty acyl-CoA ligase, fatty acyl-CoA dehydrogenase, enoyl-CoA hydratase, 3-hydroxyacylCoA dehydrogenase, enoyl-CoA isomerase, and 2,4 dienoyl-CoA reductase.

See also: [Fatty Acids](#), [Coenzyme A](#), [Oxidation of Fatty Acids](#), [Fat Synthesis](#), [Elongation of Fatty Acids](#), [Fatty Acid Desaturation](#), [Thiolase](#)

Acyl Carrier Protein (ACP)

ACP is a protein that carries acyl moieties in fatty acid biosynthesis. It contains a phosphopantetheine moiety as found in coenzyme A ([Figure 18.26](#)). **ACP** may have a role acting as a swinging arm that carries the acyl moiety through the multiple activities of the fatty acid synthase complex.

ACP is covalently linked to acetyl-CoA and malonyl-CoA by the enzymes acetyl-CoA-ACP transacylase and malonyl-CoA-ACP transacylase, respectively.

See also: [Acetyl-CoA-ACP Transacylase](#), [Malonyl-CoA-ACP Transacylase](#)

INTERNET LINK: [Fatty Acid Biosynthesis](#)

Figure 18.26: Phosphopantetheine as the reactive unit in ACP and CoA.

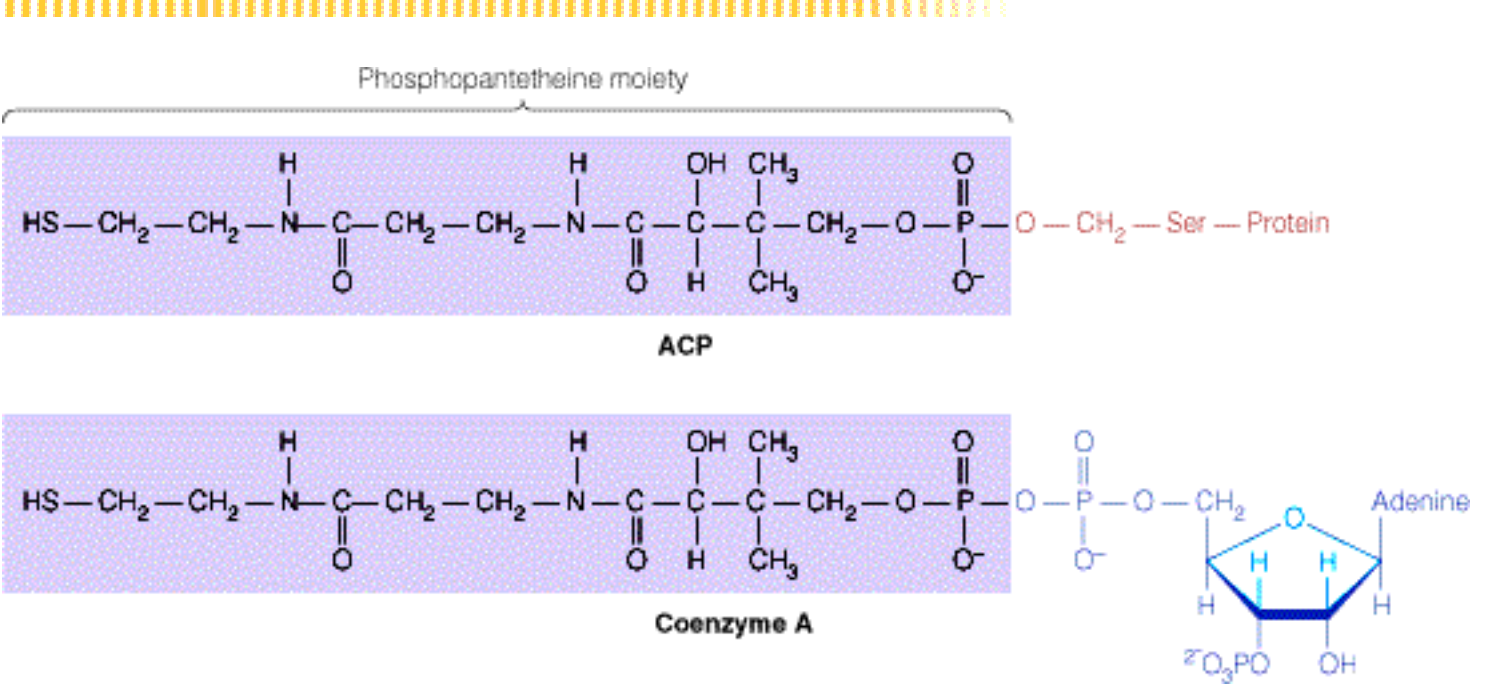

Malonyl-CoA-ACP Transacylase

Malonyl-CoA-ACP transacylase catalyzes the reaction below in fatty acid biosynthesis ([Figure 18.24](#)):

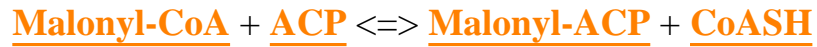

See also: [Fatty Acid Biosynthesis Strategy](#), [Fatty Acid Synthase](#), [Fatty Acids](#), [Palmitate Synthesis from Acetyl-CoA](#), [Synthesis of Long Chain Fatty Acids](#)

INTERNET LINK: [Fatty Acid Biosynthesis](#)

Malonyl-CoA

Malonyl-CoA is an intermediate in fatty acid biosynthesis. It is produced in the reaction that follows ([Figure 18.24](#)):

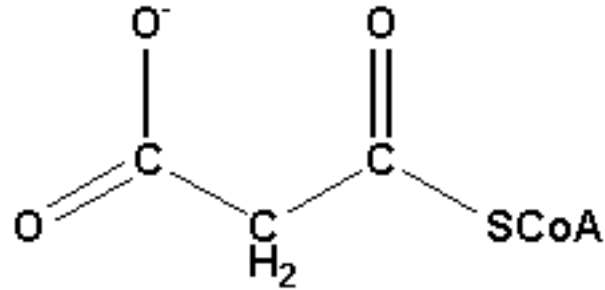

Malonyl-CoA

Subsequently, **Malonyl-CoA** is converted to malonyl-ACP in the next reaction of fatty acid biosynthesis:



See also: [Fatty Acid Biosynthesis Strategy](#), [Fatty Acid Synthase](#), [Fatty Acids](#), [Palmitate Synthesis from Acetyl-CoA](#), [Synthesis of Long Chain Fatty Acids](#), [Figure 18.27](#)

INTERNET LINK: [Fatty Acid Biosynthesis](#)

Malonyl-ACP

Malonyl-ACP is an intermediate in fatty acid biosynthesis. It is produced in the reaction below ([Figure 18.24](#)):



Malonyl-ACP subsequently donates an acetyl group to growing fatty acid chain in reaction that follows:



See also: [Fatty Acid Biosynthesis Strategy](#), [Fatty Acid Synthase](#), [Fatty Acids](#), [Palmitate Synthesis from Acetyl-CoA](#), [Synthesis of Long Chain Fatty Acids](#), [Figure 18.27](#)

INTERNET LINK: [Fatty Acid Biosynthesis](#)

Acetyl-ACP

Acetyl-ACP is a starting molecule for fatty acid biosynthesis and is produced in the reaction shown below.



See also: [Fatty Acid Biosynthesis Strategy](#), [Fatty Acid Synthase](#), [Fatty Acids](#), [Palmitate Synthesis from Acetyl-CoA](#), [Synthesis of Long Chain Fatty Acids](#), [Figure 18.24](#), [Figure 18.27](#)

INTERNET LINK: [Fatty Acid Biosynthesis](#)

Fatty Acid Biosynthesis Strategy

Fatty acid biosynthesis is similar in all known prokaryotes and eukaryotes. In eukaryotes, the biosynthesis of a fatty acid such as palmitate (C16) occurs in the cytoplasm. The basic strategy includes the following three possible steps:

- 1) [Synthesis of Palmitate from Acetyl-CoA](#)
- 2) [Chain Elongation of Palmitate](#) (long chain fatty acids)
- 3) [Fatty Acid Desaturation](#)

Though the reactions in fatty acid biosynthesis resemble the reversal of the analogous reactions in β oxidation, fatty acid synthesis is distinct from fatty acid oxidation ([Figure 18.23](#)). For example, acyl groups are carried by acyl carrier protein in fatty acid synthesis, instead of coenzyme A. Furthermore, reducing equivalents come from NADPH and energy is provided by [ATP](#). Overall, the biosynthesis of palmitate from 8 [acetyl-CoAs](#) requires 7 ATPs and 14 [NADPHs](#).

Most of the enzymatic activities required for the synthesis of palmitate from acetyl-CoA are found on a multienzyme complex called [fatty acid synthase](#) that is composed of two polypeptide chains.

See also: [Palmitate](#), [\$\beta\$ Oxidation of Saturated Fatty Acids](#)

INTERNET LINK: [Fatty Acid Biosynthesis](#)

Synthesis of Palmitate from Acetyl-CoA

Fatty acid biosynthesis from acetyl-CoA to palmitate involves an enzyme complex called fatty acid synthase, which appears to operate by a swinging arm mechanism involving the growing fatty acyl group linked to acyl carrier protein ([Figure 18.29](#)). Each of the individual enzymatic activities below is a part of the fatty acid synthase complex.

The first step in the synthesis of palmitate is the synthesis of malonyl-CoA from acetyl-CoA and HCO₃⁻ ([Figure 18.24](#)). This reaction requires ATP and is catalyzed by [acetyl-CoA carboxylase](#). It is the point of regulation of the pathway. The active form of acetyl-CoA carboxylase is a long filamentous array of monomer units. The individual monomers are generally inactive. The malonyl-CoA produced in this reaction, along with acetyl-CoA, provide substrates for the fatty acid synthase complex. The various enzymatic activities of the fatty acid synthase complex are summarized as follows ([Figure 18.27](#)).

1. [Acetyl-CoA](#) + [ACP](#) \rightleftharpoons [Acetyl-ACP](#) + CoASH (catalyzed by [Acetyl-CoA-ACP Transacylase](#))
2. [Malonyl-CoA](#) + [ACP](#) \rightleftharpoons [Malonyl-ACP](#) + CoASH (catalyzed by [Malonyl-CoA-ACP Transacylase](#))
3. [Acetyl-ACP](#) + [Malonyl-ACP](#) \rightleftharpoons [\$\beta\$ -Ketoacyl-ACP](#) + [ACP](#) + CO₂ (catalyzed by [\$\beta\$ -Ketoacyl-ACP Synthase](#))
4. [\$\beta\$ -Ketoacyl-ACP](#) + NADPH + H⁺ \rightleftharpoons [D-3-Hydroxyacyl-ACP](#) + NADP⁺ (catalyzed by [\$\beta\$ -ketoacyl-ACP reductase](#))
5. [D-3-Hydroxyacyl-ACP](#) \rightleftharpoons [Trans- \$\Delta^2\$ -enoyl-ACP](#) + H₂O (catalyzed by [3-Hydroxylacyl-ACP Dehydrogenase](#))
6. [Trans- \$\Delta^2\$ -enoyl-ACP](#) + NADPH + H⁺ \rightleftharpoons [Acyl-ACP](#) + NADP⁺ (catalyzed by [Enoyl-ACP Reductase](#))

Starting with acetyl-CoA, the process cycles between steps 1-6 seven times to yield palmitoyl-ACP, which is hydrolyzed to give palmitate and ACP. Note that the CO₂, which was added to acetyl-CoA in the acetyl-CoA carboxylase-catalyzed step, is removed subsequently and not incorporated into the final product.

See also: [Fatty Acid Biosynthesis Strategy](#), [Figure 18.23](#), [Figure 18.24](#), [Fatty Acid Synthase](#)

INTERNET LINK: [Fatty Acid Biosynthesis](#)

Figure 18.29: A swinging arm mechanism in the eukaryotic fatty acid synthase complex.

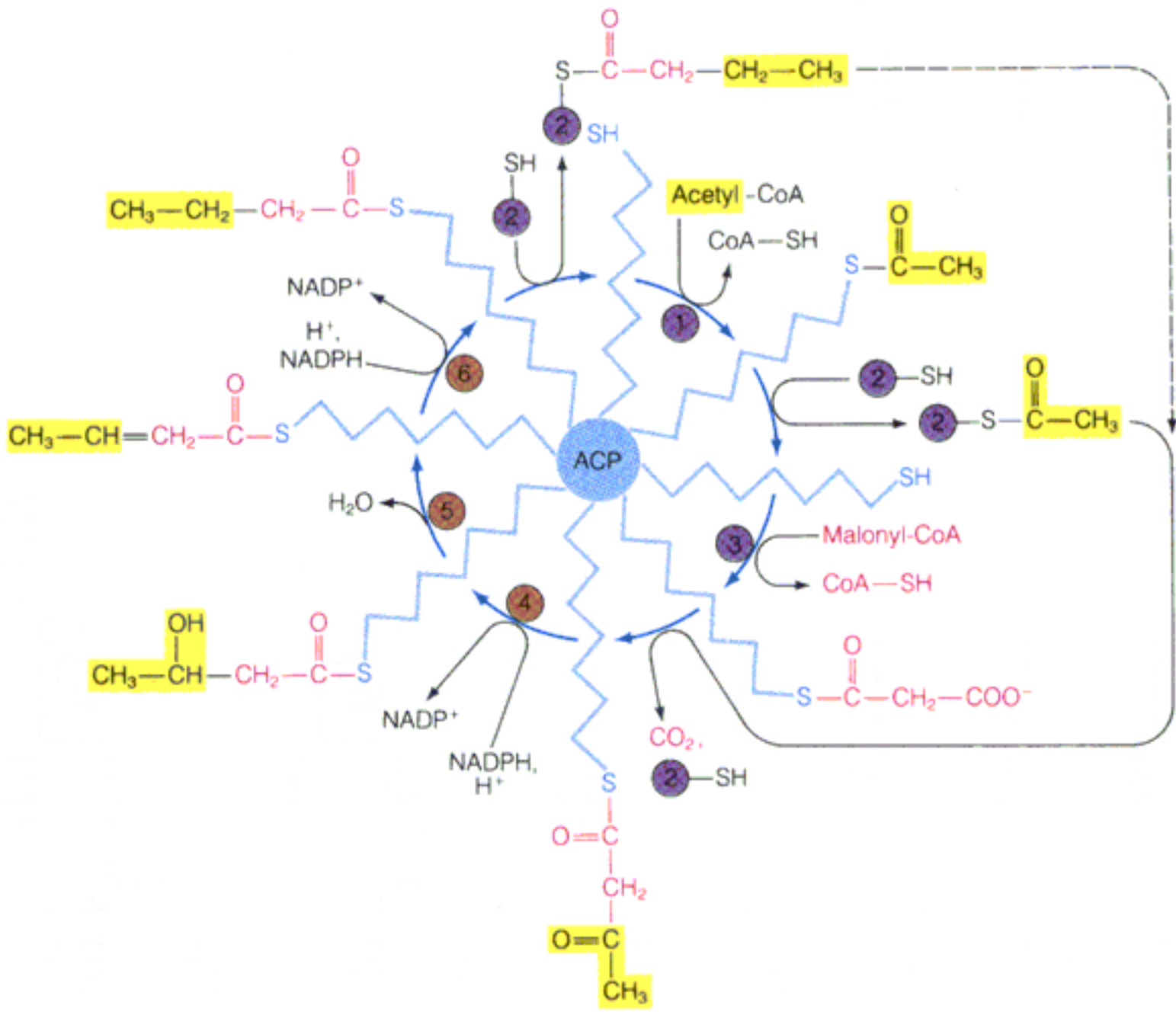

Acetyl-CoA Carboxylase

Acetyl-CoA carboxylase is the primary regulatory enzyme in fatty acid biosynthesis. The active form of the enzyme is a long filamentous array of monomer units. Monomeric units can be either phosphorylated (polymer not favored) or dephosphorylated (polymer formation favored).

Acetyl-CoA carboxylase can be phosphorylated by two kinases, cAMP-dependent protein kinase or AMP-dependent protein kinase.

The enzyme catalyzes the addition of a carboxyl group from bicarbonate to acetyl-CoA, forming malonyl-CoA.

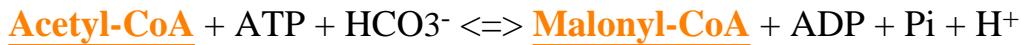

Like other carboxylases, **acetyl-CoA carboxylase** contains a biotin cofactor.

See also: Fatty Acid biosynthesis, Control of Fatty Acid Synthesis, Maintaining Blood Glucose levels

INTERNET LINKS:

1. Fatty Acid Biosynthesis
-

cAMP-Dependent Protein Kinase (cAPK)

Activation of adenylate cyclase by epinephrine or glucagon produces cAMP, which promotes the dissociation of **cAMP-dependent protein kinase** (R2C2) to give free catalytic monomers (C). C is the protein kinase, which phosphorylates other proteins.

Proteins phosphorylated by **cAPK** include: glycogen phosphorylase b kinase (activates), PFK-2 (inactivates), acetyl CoA carboxylase (inactivates), hormone-sensitive triacylglycerol lipase (activates), glycogen synthase (inactivates).

See also: Figure 13.18, Figure 16.11, Kinase Cascade, G Proteins and Signal Transduction

Epinephrine

Epinephrine, also known as **adrenaline**, is the principal hormone governing the "fight or flight" response to various stimuli. In addition to stimulating glycogenolysis, the hormone triggers a variety of physiological events, such as increasing depth and frequency of heartbeats.

Epinephrine is secreted from the adrenal medulla and binds to specific receptors on muscle cell membranes. Binding of the hormone at the membrane stimulates the synthesis of **cAMP** by membrane-bound **adenylate cyclase**, through the action of a G protein, Gs. cAMP in turn activates **cAMP-dependent protein kinase**, which catalyzes the phosphorylation of **phosphorylase b kinase** (**Figure 16.11**, **Figure 13.18**). This kinase in turn catalyzes the phosphorylation of **phosphorylase b** to **a** and, hence, the activation of glycogen breakdown, through the action of phosphorylase a. These events explain how the secretion of relatively few molecules of hormone, such as **epinephrine**, can, within just a few moments, trigger a massive conversion of **glycogen** to **glucose-1-phosphate**.

The effects of **epinephrine** are opposed by **insulin**

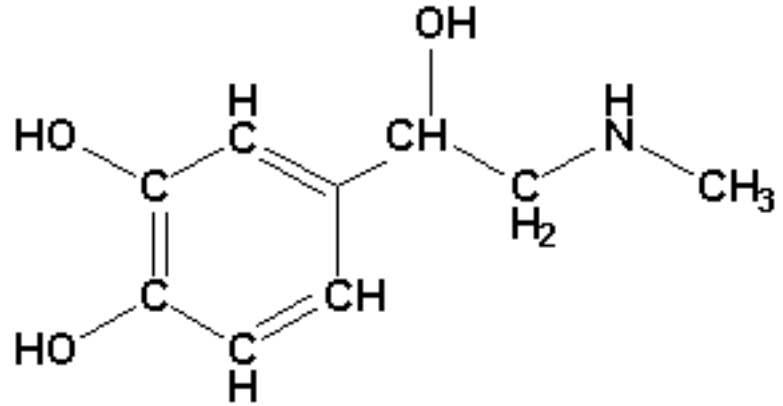

Epinephrine

See also: [Glucagon](#), [Kinase Cascade](#), [Catecholamines](#), [Isoproterenol](#), [Action of Epinephrine](#), [Norepinephrine](#)

Glycogen Phosphorylase b Kinase

Glycogen phosphorylase b kinase (also called **synthase-phosphorylase kinase (SPK)** or simply **phosphorylase b kinase**) is part of the glycogen kinase cascade regulatory system ([Figure 13.18](#)). The enzyme is converted from the inactive form to active by phosphorylation catalyzed by [cAMP-dependent protein kinase](#). **Glycogen phosphorylase b kinase**, when active, phosphorylates the glycogen phosphorylase b (less active form) to convert it to the more active form (glycogen phosphorylase a).

[Calmodulin](#) plays a special role as an integral subunit of the enzyme. This dependence is particularly important in muscle, where contraction is stimulated by calcium release. Thus, Ca^{2+} plays a dual role, in provision of the energy substrates needed to support muscle contraction and in contraction itself.

See also: [Glycogen](#), [Kinase Cascade](#), , [Glycogen Phosphorylase b](#), [Glycogen Phosphorylase a](#)

Figure 13.18: The regulatory cascade controlling glycogen breakdown.

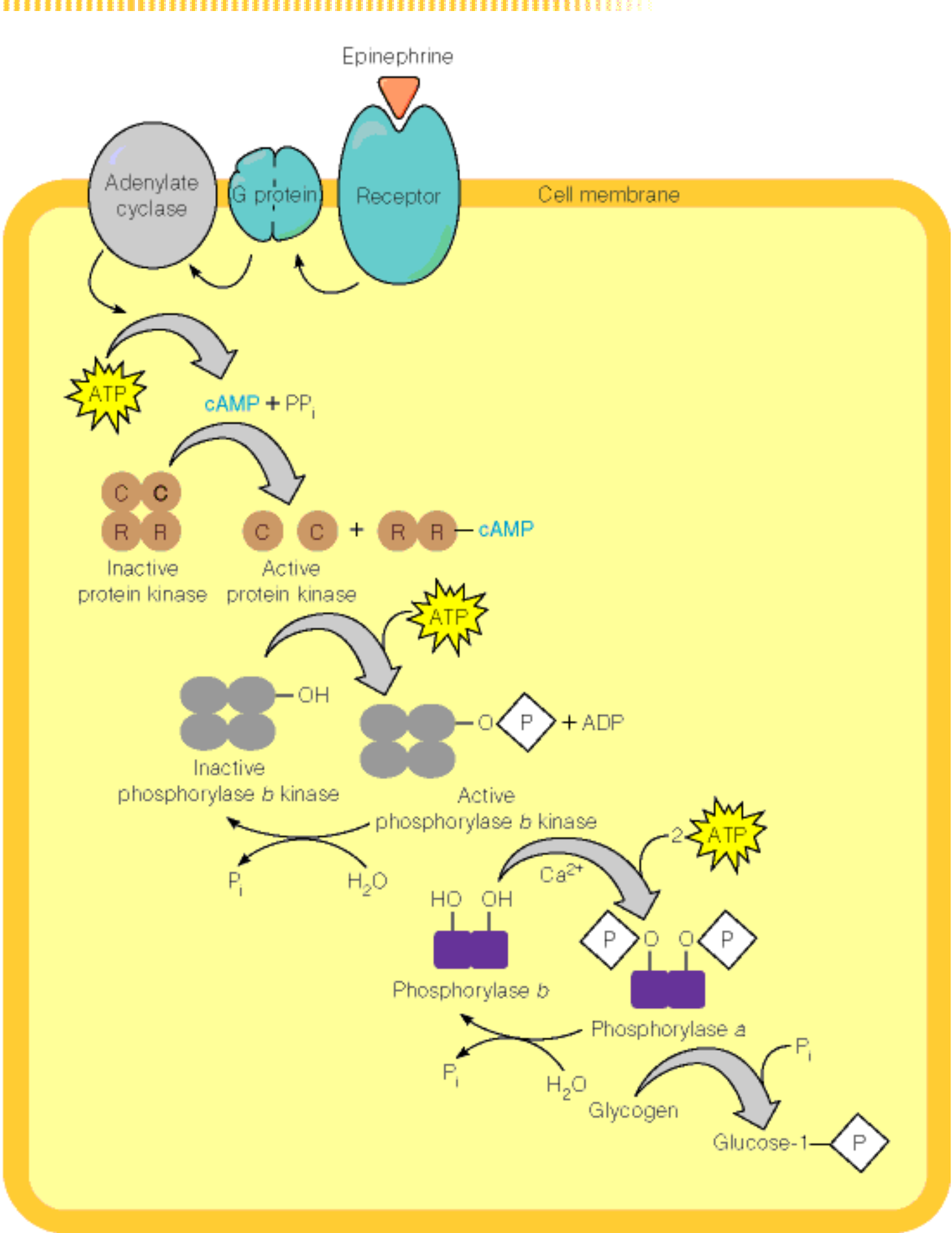



Calmodulin

Calmodulin is a small protein ($M_r \sim 17,000$) which contains four calcium ion binding sites ([Figure 13.20](#)). Each site binds Ca^{++} with a K_D of about 10^{-6} M, consistent with observations that calcium can effect intracellular metabolic changes in concentrations as low as 1 mM.

Binding of calcium stimulates a major conformational change in the protein, leading to a more compact and more highly helical structure, which augments the affinity of **calmodulin** for a number of regulatory target proteins.

When bound to calcium, **calmodulin** plays a special role as an integral subunit of the glycogen metabolism enzyme, [phosphorylase b kinase](#). Hence, the glycogenolysis cascade depends on intracellular calcium concentration as well as on [cyclic AMP](#) levels. This dependence is particularly important in muscle, where contraction is stimulated by calcium release. Thus, Ca^{++} plays a dual role, in provision of the energy substrates needed to support muscle contraction and in contraction itself.

In addition to phosphorylase b kinase, the calmodulin-calcium complex binds to other proteins, including the myosin light chain kinase in muscle, which helps to stimulate muscular contraction.

See also: [Cyclic AMP-Dependent Protein Kinase](#), [Calcium in Muscular Contraction](#) (from Chapter 8)

Figure 13.20: Calmodulin.

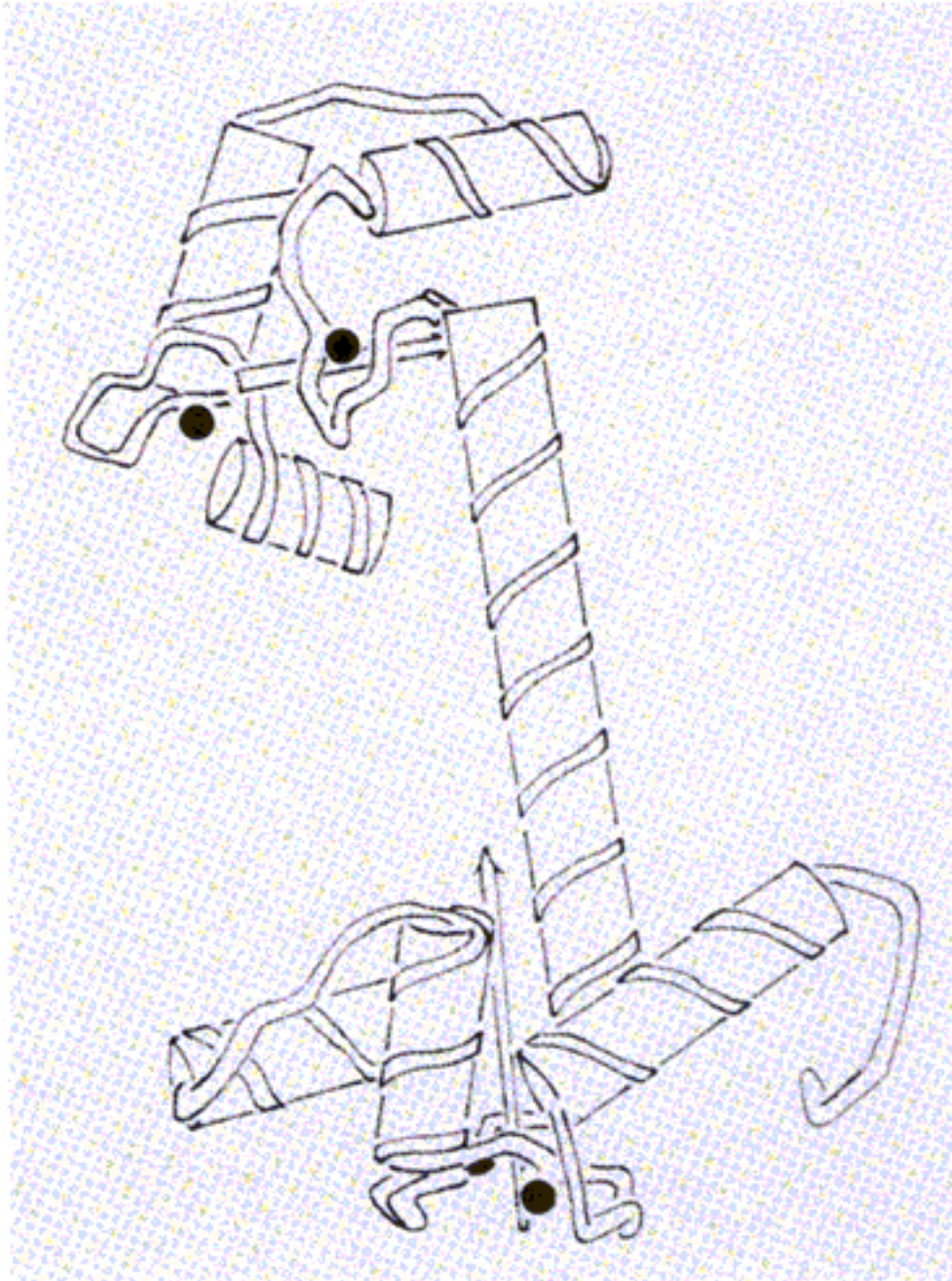

Reprinted from R. H. Kretsinger, S. E. Rudwick, and L. J. Weissman, *J. Inorg. Chem.* (1986) 28:293.
Copyright © 1986 Elsevier Press.

The Role of Calcium in Contraction

Release of **calcium** ions by the sarcoplasmic reticulum ([Figure 8.15](#)) in response to signals from the nervous system is the signal that ultimately stimulates muscular contraction. In the absence of **calcium** from the sarcoplasmic reticulum, access of the headpiece to the thin filament is blocked by the proteins tropomyosin and the troponins (I, C, and T) ([Figure 8.13](#)). **Calcium** binding by troponin C causes a rearrangement of the troponin-tropomyosin-actin complex, allowing actin-myosin cross-bridges to form.

See also: [Actin and Myosin](#), [The Structure of Muscle](#), [The Sliding Filament Model](#), [Tropomyosin](#), [Troponins](#)

Figure 8.15: Structure of a myofiber (muscle cell).

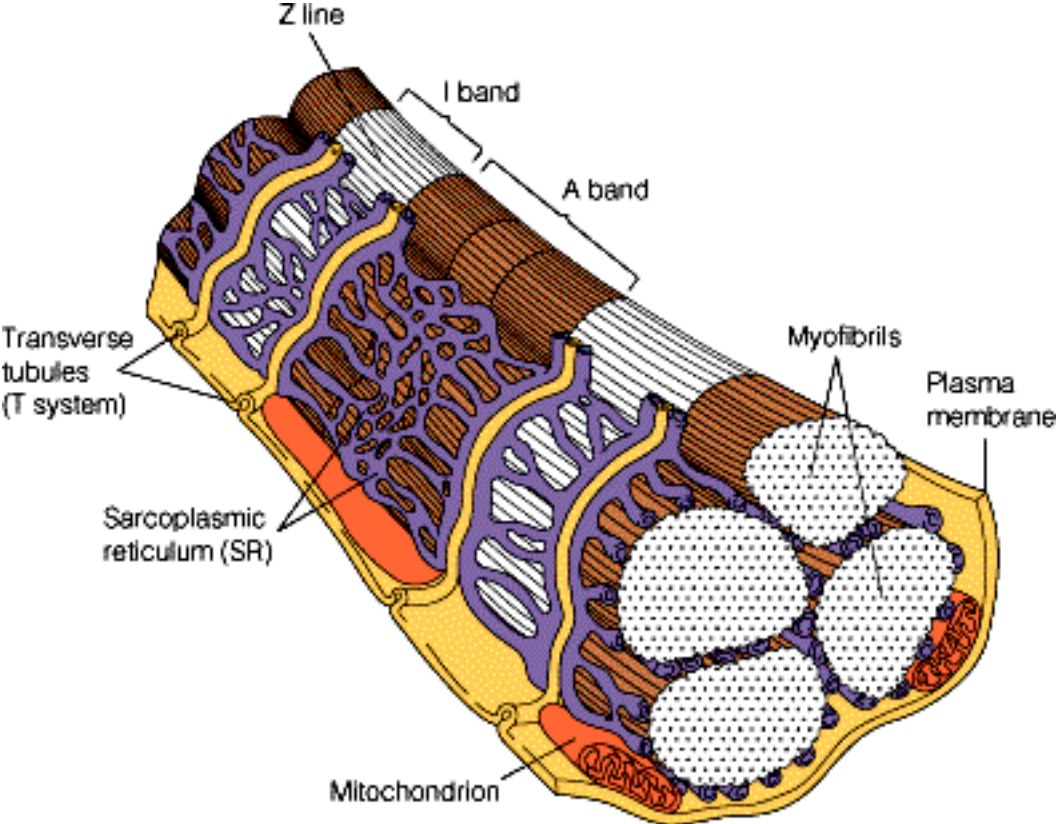

From W. M. Becker, L.J. Kleinsmith, and J. Hardin, *The World of the Cell*, 4th ed. (San Francisco, CA: Addison Wesley Longman, 2000) © Addison Wesley Longman, Inc.

Figure 8.13: F-actin and its associated proteins.

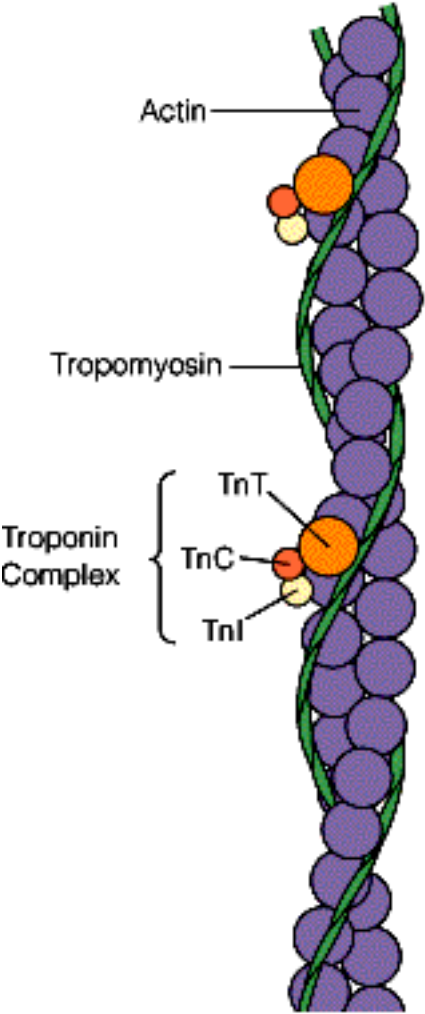

Actin and Myosin

The major proteins in muscle are **actin** and **myosin**. **Actin** and **myosin** are also found in many other kinds of cells besides muscles and are involved in several kinds of cellular and intracellular motions (e. g., cell motility and changes of cell shape).

Actin - Under physiological conditions, actin exists as a long, helical polymer (fibrous **actin**, or **F-actin**) of a globular protein monomer (**G-actin**). The structure of the **G-actin** monomer, shown in [Figure 8.1](#), is a two-domain molecule with a mass of 42,000 Daltons. The binding of ATP by a **G-actin** monomer leads to polymerization (i.e., the formation of **F-actin**). The ATP is subsequently hydrolyzed, but the ADP is retained in the **actin** filament. Within **F-actin** filaments, the **G-actin** monomers are arranged in a two-strand helix. Because the subunits are asymmetric, each **F-actin** filament has two distinguishable ends called the plus end and the minus end. The polymerization reaction exhibits a preferred direction—the plus end grows much more rapidly than the minus end. **Actin** filaments carry sites on each subunit that can bind to **myosin**.

Myosin - The functional **myosin** molecule ([Figure 8.3](#)) is composed of six polypeptide chains: two identical heavy chains (M = 230,000) and two each of two kinds of light chains (M = 20,000) - together they form a complex of molecular weight 540,000. The heavy chains have long α -helical tails and globular head domains. The α -helical tails are interwound into a two-strand coiled coil and the light chains are bound to the globular head domains. Between each head domain and tail domain is a flexible stalk. The coiled-coil structure of the tails is reminiscent of the structure of α -keratin (see [Figure 6.11a](#)).

The **myosin** molecule can be cleaved by proteases, as shown in [Figure 8.4](#). The tail domain can be cleaved at a specific point by trypsin to yield fragments called light meromyosin and heavy meromyosin. **Myosin** exhibits aspects of both fibrous and globular proteins, and its functional domains play quite different roles. The tail domains have a pronounced tendency to aggregate, causing **myosin** molecules to form thick bipolar filaments. The head domains, with their attached light chains, are often called headpieces; they have a strong tendency to bind to **actin**.

See also: [The Sliding Filament Model](#), [The Structure of Muscle](#), [Nonmuscle Actin and Myosin](#), [Headpieces](#)

Figure 8.1: G-actin.

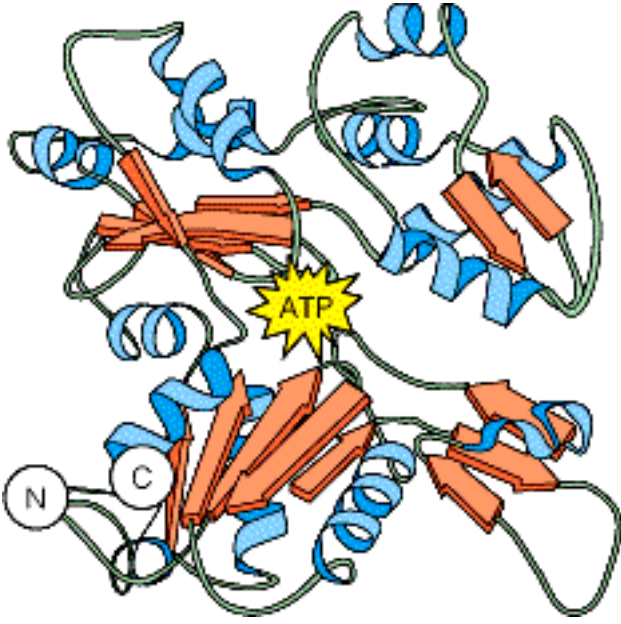

Adapted from Dr. W. Kabsch.

Figure 8.3: The myosin molecule.

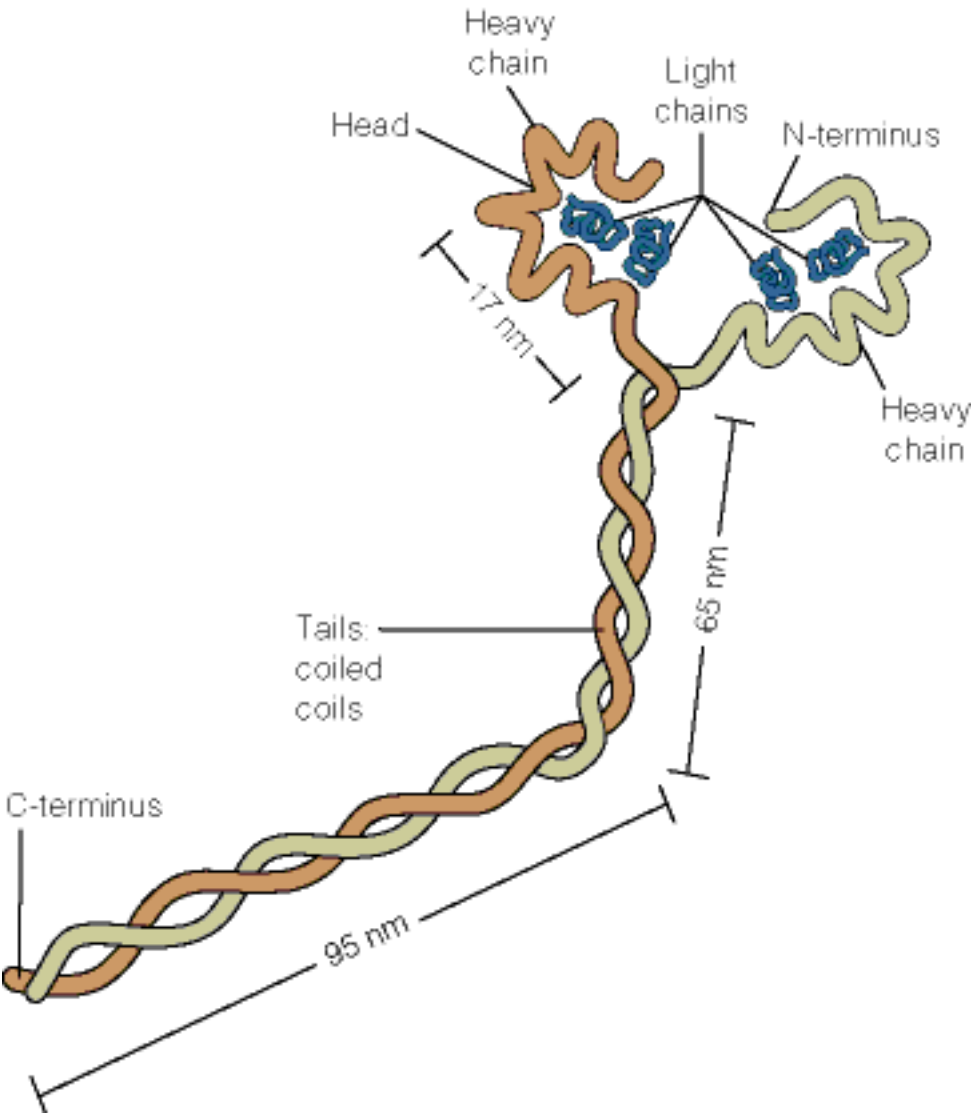

Figure 6.11: Proposed structure for keratin-type intermediate filaments.

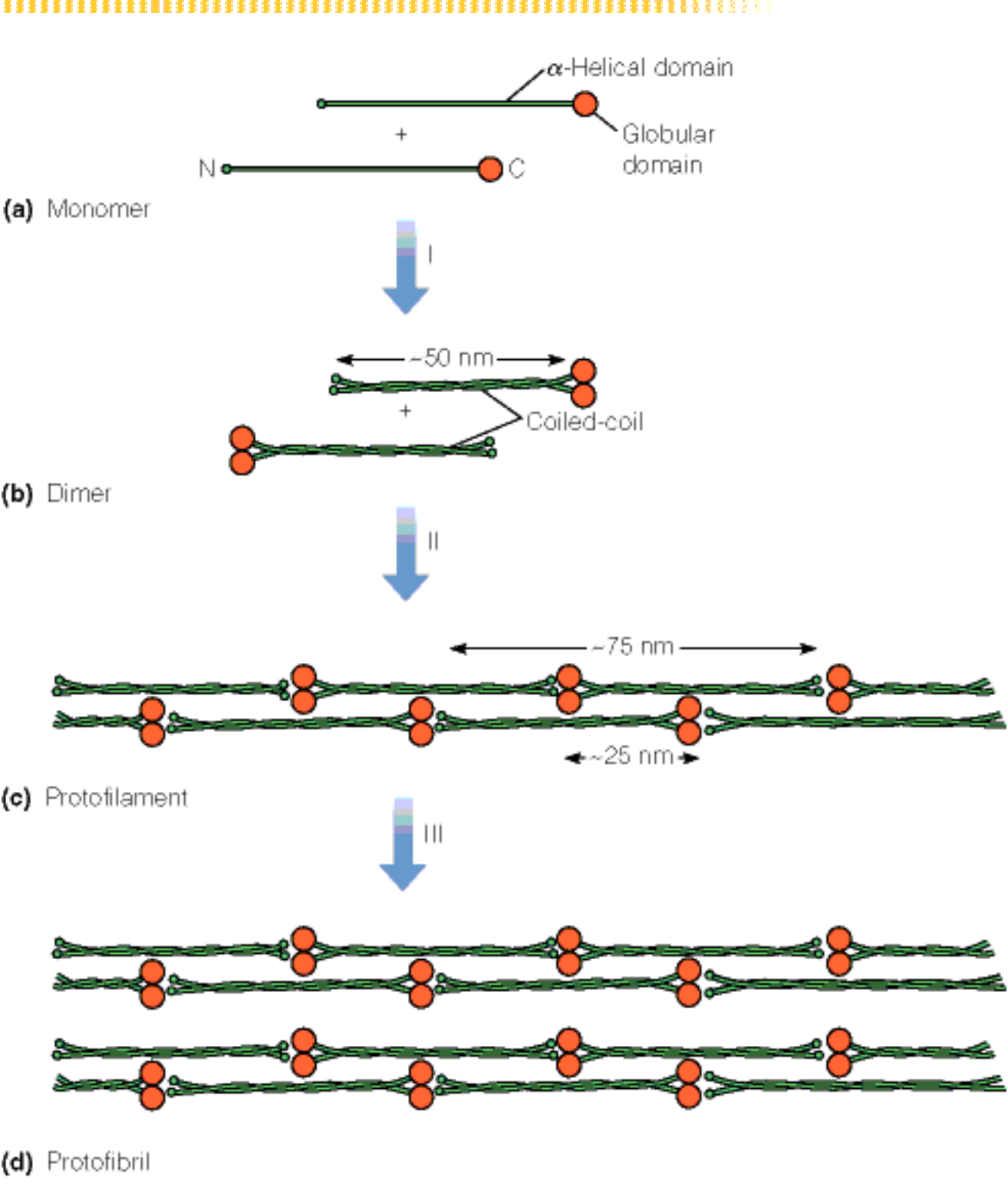
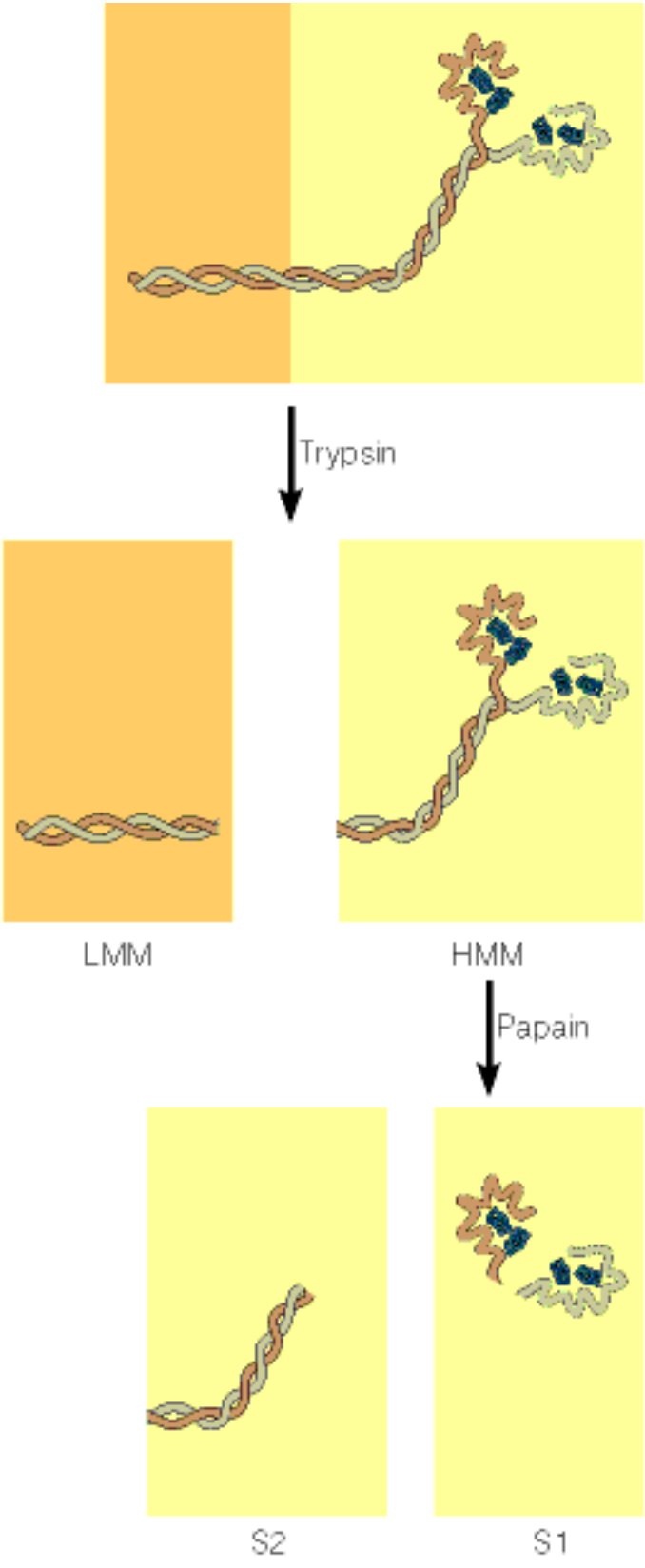

Figure 8.4: Dissection of myosin by proteases.



The Sliding Filament Model



The sliding filament model explains the molecular basis by which muscular contraction occurs. During muscular contraction, thin filaments within the sarcomere of a myofibril are pulled towards the center of the sarcomere (called the H zone) by the thick filaments. In the process, the sarcomeric length shortens and the myofibril shortens. As a result, the muscle contracts (see [Figure 8.11](#)). Steps in the process include the following:

1. Muscular contraction is initiated by a signal from the nervous system.
2. The nervous system causes release of calcium from the sarcoplasmic reticulum.
3. Calcium release causes thick filaments of the cocked headpiece of a myosin filament (thick filament) to bind to a site on [actin](#), forming a tight cross-bridged binding. In the absence of calcium from the sarcoplasmic reticulum, access of the headpiece to the thin filament is blocked by tropomyosin and the troponins (I, C, and T) ([Figure 8.13](#)). Calcium binding by troponin C causes a rearrangement of the troponin-tropomyosin-actin complex, allowing actin-myosin cross-bridges to form.
4. Release of phosphate and [ADP](#) from a previously hydrolyzed [ATP](#) on the thick filament causes it to perform a "power stroke", pulling the thin filament (actin) in towards the center of the sarcomere.
5. The binding of ATP causes the cross-bridge between actin and [myosin](#) to be broken and the myosin headpiece to remain in the low energy configuration. In the absence of calcium, the actin can slide back past the myosin to the original relaxed position.
6. ATP is hydrolyzed, but not released by the myosin headpiece, causing the myosin headpiece to assume the cocked position.
7. When the stimulation from the nervous system ceases, calcium is taken up again by the sarcoplasmic reticulum.
8. The resulting decrease in calcium concentration causes the thin filament to slide back past the thick filament and the muscle to relax.

See also: [The Structure of Muscle](#), [Actin and Myosin](#), [Sarcoplasmic Reticulum](#), [Headpieces](#), [Tropomyosin](#), [Troponins](#)



Figure 8.11: The current view of the ATP cycle in muscle contraction.

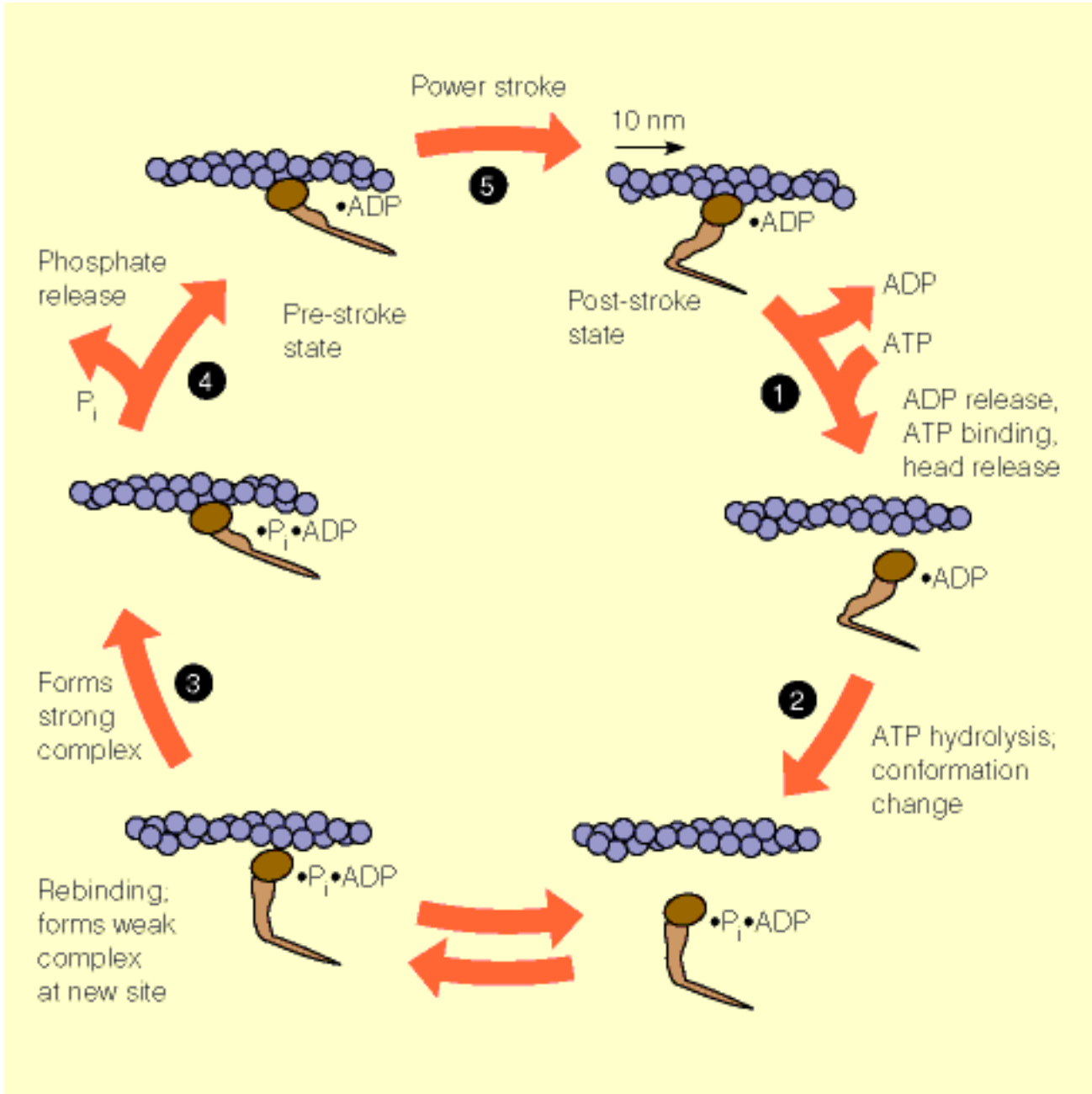

Adapted from J. Spudich, Nature (1994) 372:515-518. © 1994 Macmillan Magazines, Ltd.

The Structure of Muscle

The **structure of muscle** can be viewed at the electron micrograph level shown in [Figure 8.9a](#). The **muscle** tissue is composed of bundles of **muscle** cells called **muscle** fibers. Within a **muscle** fiber are myofibrils, which are also arranged in bundles. Individual myofibrils contain the structurally distinct regions described below. Myofibrils have thin filaments composed of actin and thick filaments composed of myosin. Arrangement of the thick and thin filaments in a myofibril produces the distinctive pattern in [Figure 8.9a](#) and [Figure 8.15](#).

Muscle contraction can be explained by the [sliding filament model](#) on the basis of the structures illustrated in [Figure 8.9a](#) and described as follows:

Sarcomere - A basic unit of contraction in a myofibril. The bounds of the **sarcomere** are defined by the Z lines.

Z line - A region within an I band that defines the end of a sarcomere.

I band - A portion of the sarcomere which contains the Z line and which contains thin filaments only. During muscular contraction, the region of the **I band** will shrink as the thin filaments are pulled towards the center of each respective sarcomere by the thick filaments.

A band - A region of a myofibril composed of thick filaments and thin filaments. At the center of the **A band**, the **H zone** provides a space for the thick filaments to pull the thin filaments towards. The overall size of the **A band** remains the same during muscular contraction ([Figure 8.10](#)), but the **H zone** size diminishes.

H zone - A region in the center of the sarcomere of the myofibril composed almost exclusively of thick filaments. During muscular contraction, the **H zone** shrinks in size as thin filaments are pulled in to fill the space of the **H zone**.

Thin filaments are composed of a polymer of [actin](#) (called **F-actin**) arranged in a helix, [tropomyosin](#) (a fibrous protein that exists as elongated dimers lying along, or close to, the groove in the **F-actin** helix), and three small proteins called [troponins](#) I, C, and T. The presence of tropomyosin and the troponins inhibits the binding of [myosin](#) heads to actin unless calcium is present at a concentration of about 10^{-5} M. In resting muscle, calcium concentrations are approximately 10^{-7} M, so new cross bridges between the thick and thin filaments cannot occur.

Signals from the nervous system that cause muscle to contract are conveyed to the [sarcoplasmic](#)

reticulum via the transverse tubules (Figure 8.15). Upon receipt of the signal from the nerves, the sarcoplasmic reticulum releases calcium, which signals the muscles to contract.

Striated Muscle - Striated muscle can be divided into two categories - red muscle, designed for relatively continuous use, and white muscle, employed for occasional, often rapid motions. Red muscle owes its dark color to abundant heme proteins. It is well supplied with blood vessels and, therefore, with hemoglobin. It has many mitochondria with cytochromes and it has large stores of myoglobin. Red muscle depends heavily on aerobic metabolism in mitochondria, so the primary energy source in red muscle is the oxidation of fat. White muscle, on the other hand, relies on glycogen as a primary energy source.

See also: The Sliding Filament Model, The Role of Calcium in Contraction, ,

INTERNET LINK: Skeletal Muscle Structure

Figure 8.9a: Muscle structure seen at the EM level.

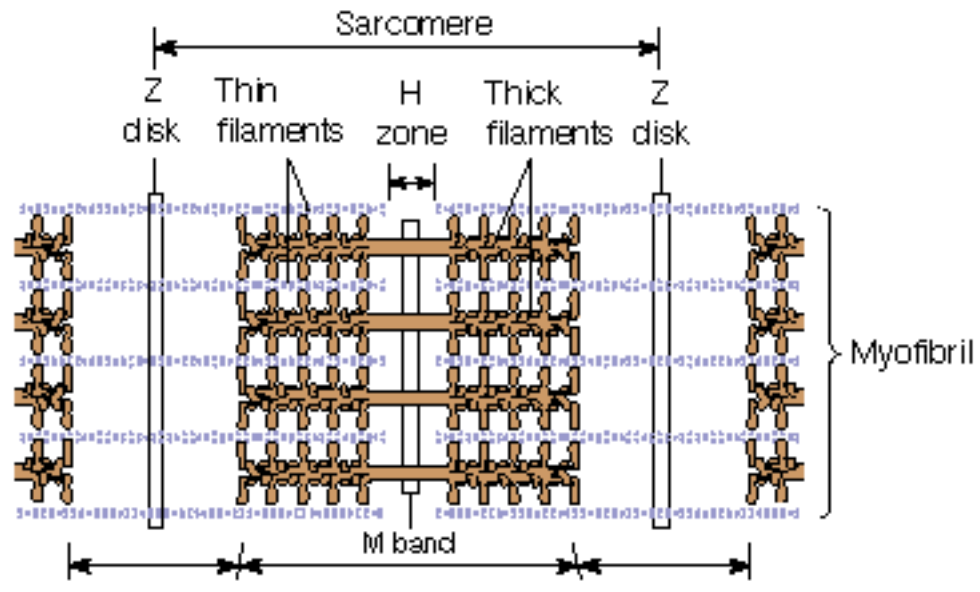
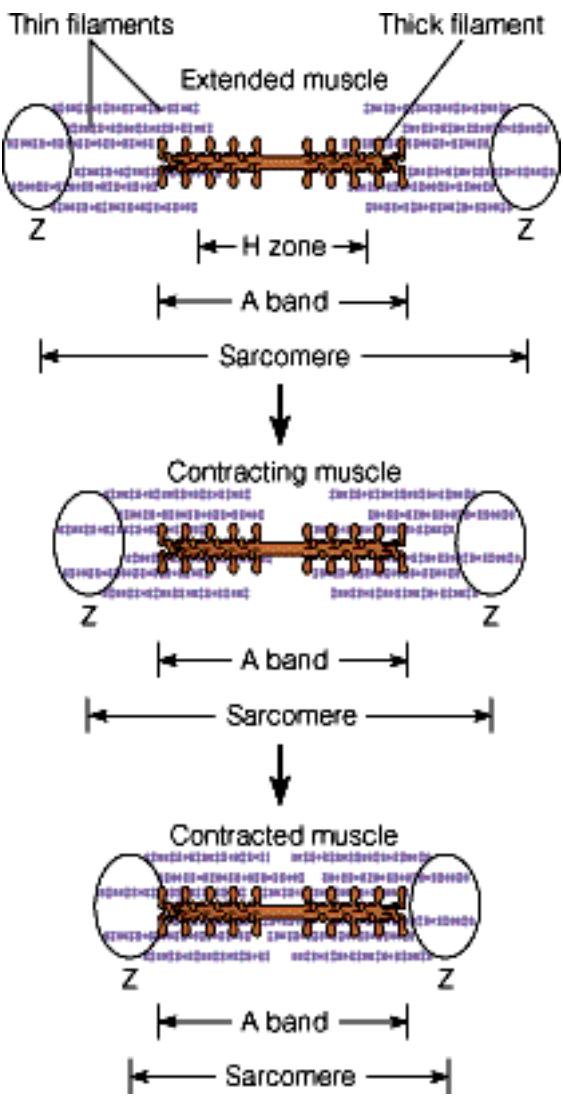

Figure 8.10: The sliding filament model of muscle contraction.



Tropomyosin

Tropomyosin is a fibrous protein that exists as elongated dimers lying along, or close to, the groove in the F-actin helix. Bound to each tropomyosin molecule are three small proteins called troponins I, C, and T. The presence of **tropomyosin** and the troponins inhibits the binding of myosin heads to actin unless calcium is present at a concentration of about 10^{-5} M. In resting muscle, Ca^{2+} concentrations are in the neighborhood of 10^{-7} M, so new cross-bridges cannot be formed. An influx of Ca^{2+} stimulates contraction, because the ion is bound by troponin C, causing a rearrangement of the troponin - tropomyosin complex. This shift makes sites on actin available for binding by the myosin headpieces. The postulated mechanism shown in [Figure 8.14](#) permits step 3 and the subsequent steps in the cycle of [Figure 8.11](#) to take place.

See also: [The Structure of Muscle](#), [Actin and Myosin](#), [The Sliding Filament Model](#), [The Role of Calcium in Contraction](#), [Troponins](#)

Figure 8.14: The regulation of muscle contraction by calcium.

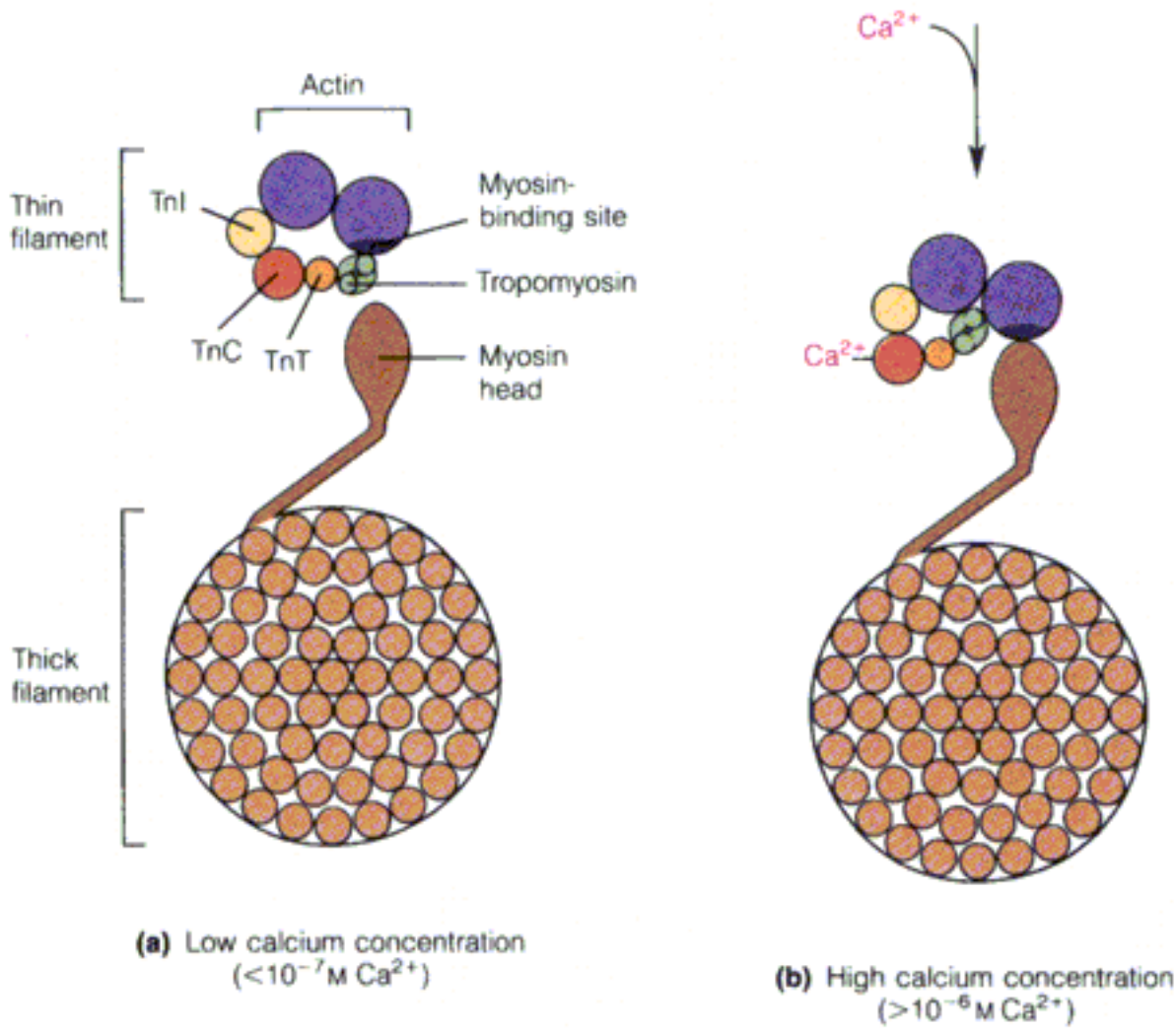

From W. M. Becker, L.J. Kleinsmith, and J. Hardin, *The World of the Cell*, 4th ed. (San Francisco, CA: Addison Wesley Longman, 2000) © Addison Wesley Longman, Inc.

Troponins

Tropomyosin is a fibrous protein that exists as elongated dimers lying along, or close to, the groove in the F-actin helix. Bound to each tropomyosin molecule are three small proteins called **troponins I, C, and T**. The presence of tropomyosin and the **troponins** inhibits the binding of myosin heads to actin unless calcium is present at a concentration of about 10^{-5} M. In resting muscle, Ca^{2+} concentrations are in the neighborhood of 10^{-7} M, so new cross-bridges cannot be formed. An influx of Ca^{2+} stimulates contraction, because the ion is bound by **troponin C**, causing a rearrangement of the **troponin** - tropomyosin complex. This shift makes sites on actin available for binding by the myosin headpieces. The postulated mechanism shown in [Figure 8.14](#) permits step 3 and the subsequent steps in the cycle of [Figure 8.11](#) to take place. Thus, binding of calcium by troponin C is ultimately responsible for the process of muscular contraction.

See also: [The Structure of Muscle](#), [Tropomyosin](#), [Actin and Myosin](#), [The Sliding Filament Model](#), [The Role of Calcium in Contraction](#)

Sarcoplasmic Reticulum

The **sarcoplasmic reticulum** ([Figure 8.15](#)) is a structure that surrounds each myofibril in muscle. The **sarcoplasmic reticulum** has a lumen within which it stores calcium ions. Upon stimulation by the nervous system, the **sarcoplasmic reticulum** depolarizes and releases calcium, which pours into the myofibrils and stimulates muscular contraction.

See also: [The Structure of Muscle](#), [The Sliding Filament Model](#), [The Role of Calcium in Contraction](#), [Transverse Tubules](#)

Transverse Tubules

The **transverse tubules** ([Figure 8.15](#)) are invaginations of the plasma membrane that connect at periodic intervals with the sarcoplasmic reticulum of muscle. The transverse tubules help to carry the signal from the central nervous system to the entire sarcoplasmic reticulum. This assists the process whereby calcium is evenly released across the myofibrils, stimulating contraction in a coordinated fashion.

See also: [Structure of Muscle](#), [The Sliding Filament Model](#), [Sarcoplasmic Reticulum](#)

Heme

The molecule called **heme** consists of a complex of protoporphyrin IX with Fe (II). **Heme** is the part of the **hemoglobin** and **myoglobin** molecules that binds to oxygen.

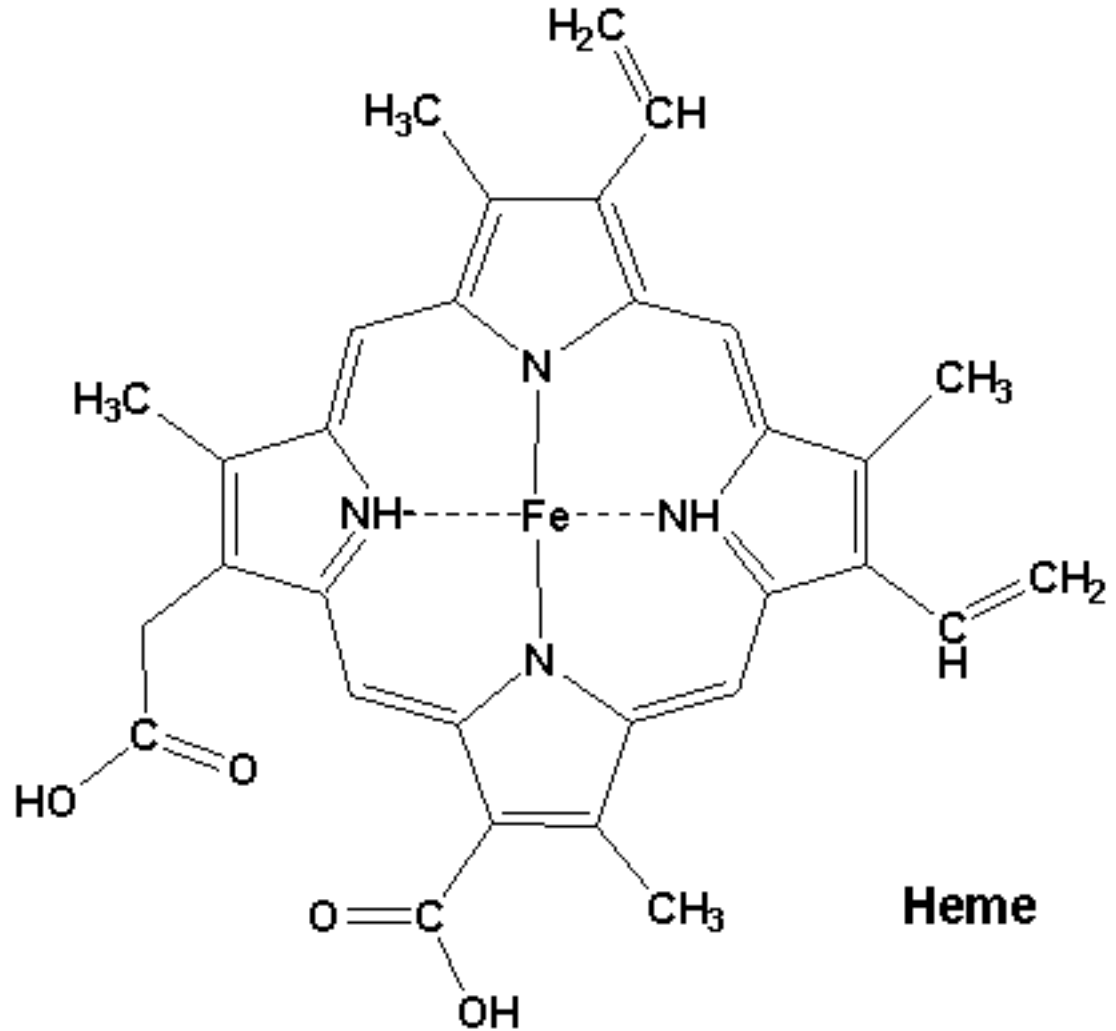

Iron-containing proteins can hold Fe(II) in a number of possible ways. Throughout the myoglobin-hemoglobin family, the iron is chelated by a tetrapyrrole ring system called protoporphyrin IX, one of a large class of porphyrin compounds. The basic ring structure of a porphyrin is shown in [Figure 7.4a](#), and protoporphyrin IX is shown in [Figure 7.4b](#). Porphyrins are also components of chlorophyll, the cytochrome proteins, and some natural pigments. Like most compounds with large conjugated ring systems, the porphyrins are strongly colored. The iron-porphyrin in hemoglobin accounts for the red color of blood, and the magnesium-porphyrin in [chlorophyll](#) is responsible for the green of plants.

Heme is noncovalently bonded in a hydrophobic crevice in the myoglobin or hemoglobin molecule (see [Figure 7.3](#)). The binding of oxygen to **heme** is illustrated in [Figure 7.5](#), which shows the oxygenated form of myoglobin. Ferrous iron is normally octahedrally coordinated, which means it should have six ligands, or binding groups, attached to it. As shown in [Figure 7.5a](#), the nitrogen atoms of the porphyrin ring account for only four of these ligands. Two remaining coordination sites are available, and they lie along an axis perpendicular to the plane of the ring. In both the deoxygenated and the oxygenated forms of myoglobin, one of these sites is occupied by the nitrogen of [histidine](#) residue number 93.

See also: [Hemoglobin](#), [Myoglobin](#), [Protoporphyrin IX](#), [Oxygen Binding by Heme Proteins](#), [Oxygen Binding by Myoglobin](#), [Oxygen Binding by Hemoglobin](#), [Porphyrin and Heme Metabolism](#)

INTERNET LINK: [Porphyrin and Chlorophyll Metabolism](#)

Hemoglobin

Hemoglobin is a **heme** containing protein responsible for transporting oxygen in the bloodstream. The heme in **hemoglobin** is in the form of an iron complexed with **protoporphyrin IX**. The protection of an oxygen-binding metal from irreversible oxidation is the functional reason for the existence of **myoglobin** and **hemoglobin**. These two molecules provide environments in which the first step of an oxidation reaction (the binding of oxygen) is permitted, but the final step (oxidation) is blocked.

See also: [Figure 7.1, The Roles of Hemoglobin and Myoglobin](#), [Oxygen Binding by Heme Proteins](#), [Oxygen Binding by Myoglobin](#), [Oxygen Binding by Hemoglobin](#), [Carbon Dioxide and Hemoglobin](#), [Bisphosphoglycerate and Hemoglobin](#), [Globin Gene Expression in Development](#), [Evolution of Myoglobin/Hemoglobin Proteins](#), [Hemoglobin Variants](#), [Thalassemias](#)

INTERNET LINKS:

1. [Hemoglobin Allostery](#)
 2. [Thalassemia Overview](#)
 3. [Sickle Cell Disease](#)
 4. [Hemoglobin Overview](#)
 5. [Globin Gene Server](#)
-

Protoporphyrin IX

Protoporphyrin IX is the backbone of [heme](#).
When iron is complexed with **protoporphyrin IX**, it is called heme. Heme is the prosthetic group in hemoglobin, myoglobin, and cytochromes b, c, and c1.

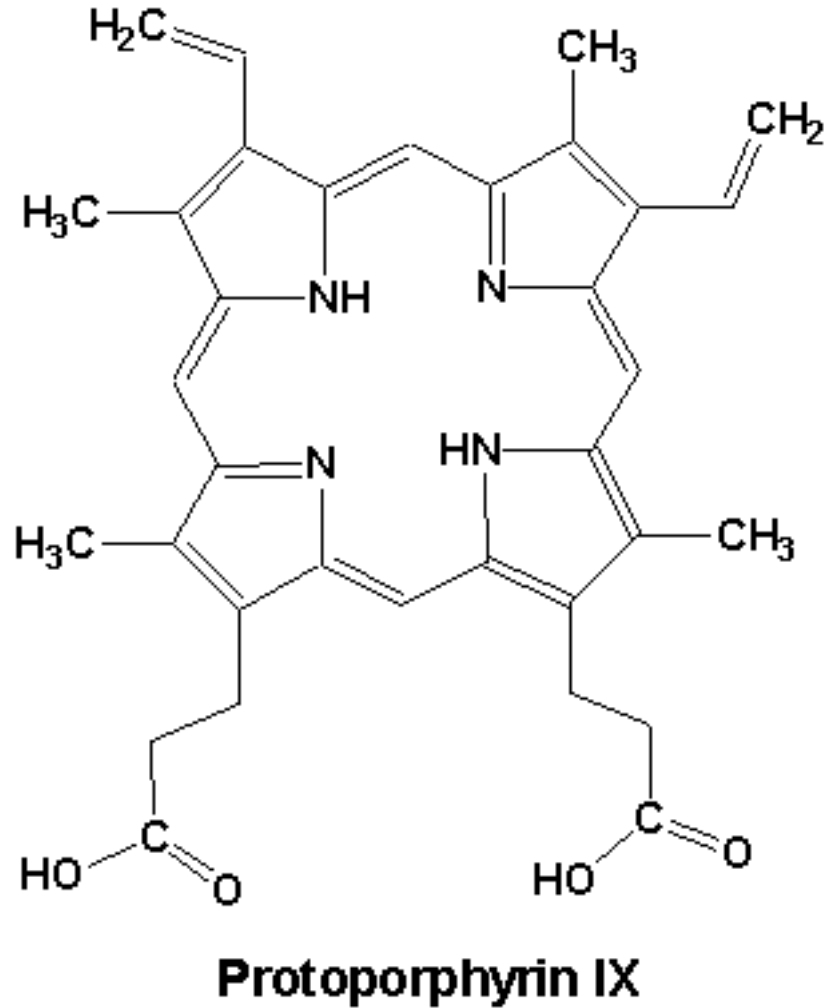

See also: [Figure 7.4](#), [Hemoglobin](#), [Myoglobin](#), [Cytochromes](#)

Figure 7.4: The structures of porphyrins.

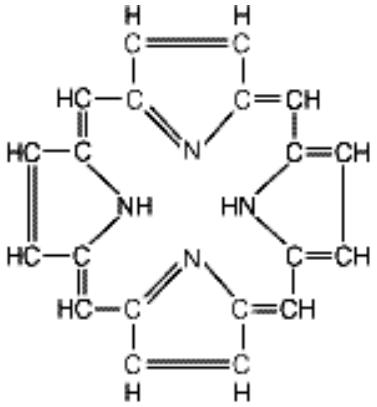

(a) Porphin (C₂₀H₁₄N₄)

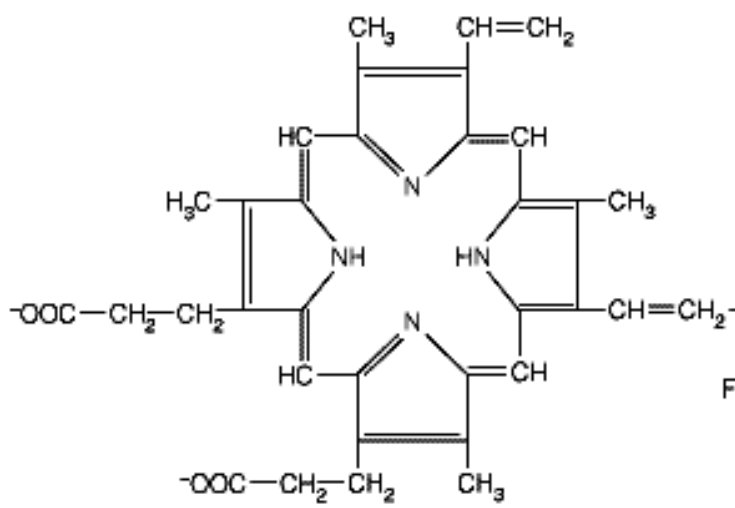

(b) Protoporphyrin IX

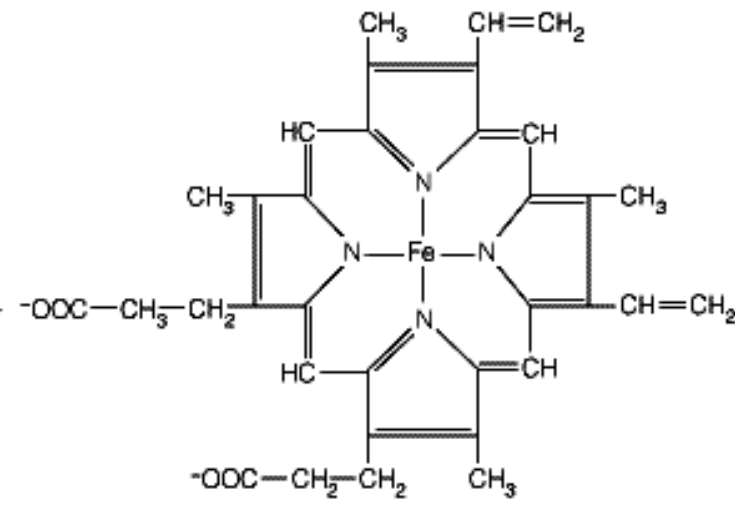
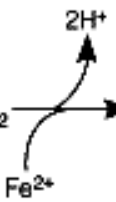

(c) Ferroprotoporphyrin (heme)

Adapted from A. White et al., Principles of Biochemistry, 6th ed. (New York: McGraw-Hill, 1978). © 1978 McGraw-Hill.

Myoglobin

Myoglobin is a **heme** containing protein responsible for storing oxygen. The heme in **myoglobin** is in the form of an iron complexed with **protoporphyrin IX**. The protection of an oxygen-binding metal from irreversible oxidation is the functional reason for the existence of **myoglobin** and hemoglobin. These two molecules provide environments in which the first step of an oxidation reaction (the binding of oxygen) is permitted, but the final step (oxidation) is blocked.

See also: [Figure 7.1](#), [Figure 5.14](#), , [The Roles of Hemoglobin and Myoglobin](#), [Oxygen Binding by Heme Proteins](#), [Oxygen Binding by Myoglobin](#), [Globin Gene Expression in Development](#), [Evolution of Myoglobin/Hemoglobin Proteins](#)

INTERNET LINK: [Globin Gene Server](#)

Figure 7.1: Role of the globins in oxygen transport and storage.

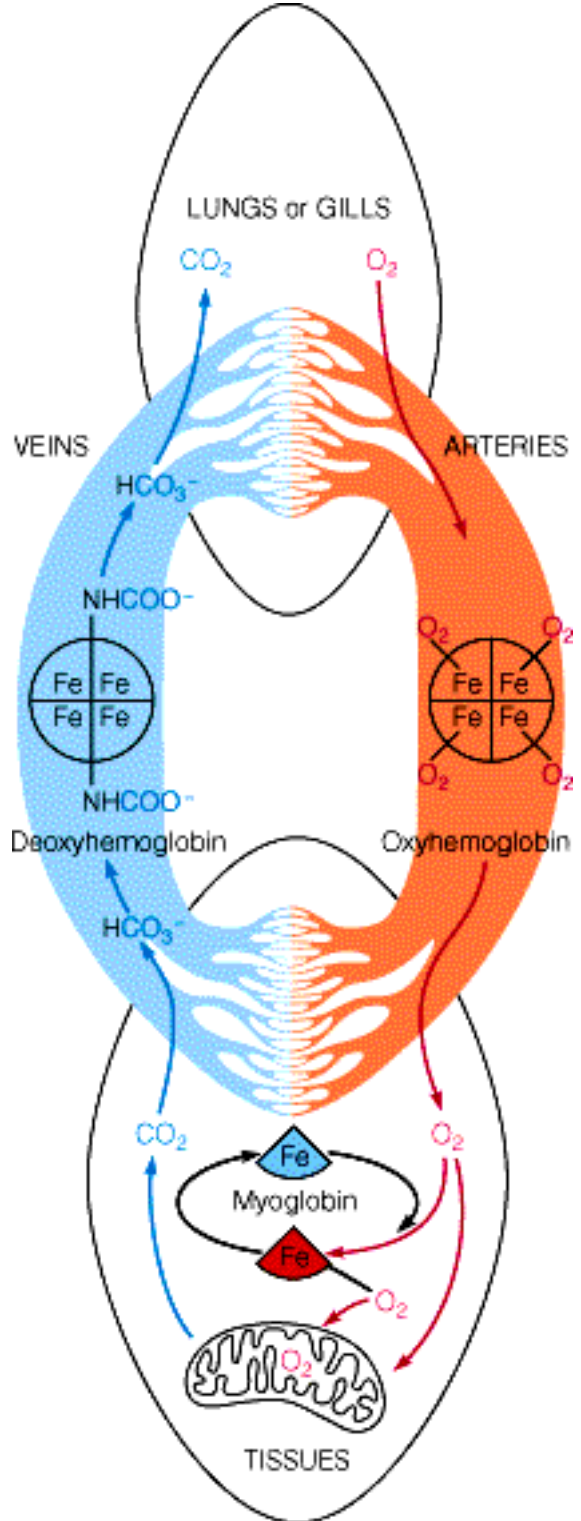

Figure 5.14: The amino acid sequences of sperm whale myoglobin and human myoglobin.



Key:

- Identical amino acids
- Conservative substitutions
- Nonconservative substitutions

Number	1	2	3	4	5	6	7	8	9	10	11	12	13	14	15			
Human	G	L	S	D	G	E	W	Q	L	V	L	N	V	W	G			
Whale	V	L	S	E	G	E	W	Q	L	V	L	H	V	W	A			
Number	16	17	18	19	20	21	22	23	24	25	26	27	28	29	30			
Human	K	V	E	A	D	I	P	G	H	G	Q	E	V	L	I			
Whale	K	V	E	A	D	V	A	G	H	G	Q	D	I	L	I			
Number	31	32	33	34	35	36	37	38	39	40	41	42	43	44	45			
Human	R	L	F	K	G	H	P	E	T	L	E	K	F	D	K			
Whale	R	L	F	K	S	H	P	E	T	L	E	K	F	D	R			
Number	48	47	48	49	50	51	52	53	54	55	56	57	58	59	60			
Human	F	K	H	L	K	S	E	D	E	M	K	A	S	E	D			
Whale	F	K	H	L	K	T	E	A	E	M	K	A	S	E	D			
Number	61	62	63	64	65	66	67	68	69	70	71	72	73	74	75			
Human	L	K	K	H	G	A	T	V	L	T	A	L	G	G	I			
Whale	L	K	K	H	G	V	T	V	L	T	A	L	G	A	I			
Number	76	77	78	79	80	81	82	83	84	85	86	87	88	89	90			
Human	L	K	K	K	G	H	H	E	A	E	I	K	P	L	A			
Whale	L	K	K	K	G	H	H	E	A	E	L	K	P	L	A			
Number	91	92	93	94	95	96	97	98	99	100	101	102	103	104	105			
Human	Q	S	H	A	T	K	H	K	I	P	V	K	Y	L	E			
Whale	Q	S	H	A	T	K	H	K	I	P	I	K	Y	L	E			
Number	106	107	108	109	110	111	112	113	114	115	116	117	118	119	120			
Human	F	I	S	E	C	I	I	Q	V	L	Q	S	K	H	P			
Whale	F	I	S	E	A	I	I	H	V	L	H	S	R	H	P			
Number	121	122	123	124	125	126	127	128	129	130	131	132	133	134	135			
Human	G	D	F	G	A	D	A	Q	G	A	M	N	K	A	L			
Whale	G	N	F	G	A	D	A	Q	G	A	M	N	K	A	L			
Number	136	137	138	139	140	141	142	143	144	145	146	147	148	149	150	151	152	153
Human	E	L	F	R	K	D	M	A	S	N	Y	K	E	L	G	F	Q	G
Whale	E	L	F	R	K	D	I	A	A	K	Y	K	E	L	G	Y	Q	G

The Roles of Hemoglobin and Myoglobin

Hemoglobin and **myoglobin** are proteins that have evolved to carry out the specialized functions of oxygen transport and storage in animals. Animals must ensure a steady supply of oxygen to body cells and remove metabolic waste products such as carbon dioxide. Diffusion transport through tissues is generally not fast enough.

Almost all animals except insects pump oxygen in the blood through arteries to the tissues and return carbon dioxide via venous blood to lungs or gills ([Figure 7.1](#)). All higher organisms have oxygen transport proteins, which allow the blood to carry a much greater load of oxygen than would be permitted by solubility alone. Oxygen transport proteins may be either dissolved in the blood (as in some invertebrates) or concentrated in specialized cells, like the human erythrocytes.

In all vertebrates the oxygen transport protein is **hemoglobin**, a protein that can pick up oxygen in lungs or gills and deliver it to tissues. **Myoglobin**, by contrast, is an oxygen storage protein. Oxygen transported to tissues must be released for utilization. In tissues, such as muscle, with high oxygen demands, **myoglobin** provides large oxygen reserves.

Myoglobin and **hemoglobin** are built on a common structural motif, as shown in [Figure 7.3](#).

Myoglobin contains a single polypeptide chain folded about a prosthetic group, the heme, which contains the oxygen binding site. **Hemoglobin** is a tetrameric protein. Each polypeptide subunit closely resembles **myoglobin**. Note, for example that myoglobin and each subunit of hemoglobin consists of eight helical segments, which are labeled A through H in [Figure 6.1](#). The multiple subunit structure of **hemoglobin** gives it important oxygen binding properties that are different than **myoglobin's**, consistent with **hemoglobin's** role in oxygen transport.

See also: [Oxygen Binding by Heme Proteins](#), [Oxygen Binding by Myoglobin](#), [Oxygen Binding by Hemoglobin](#), [Hemoglobin Allostery](#), [Models of Allosteric Activity](#), [Carbon Dioxide and Hemoglobin](#)

Figure 7.3: Comparison of myoglobin and hemoglobin.

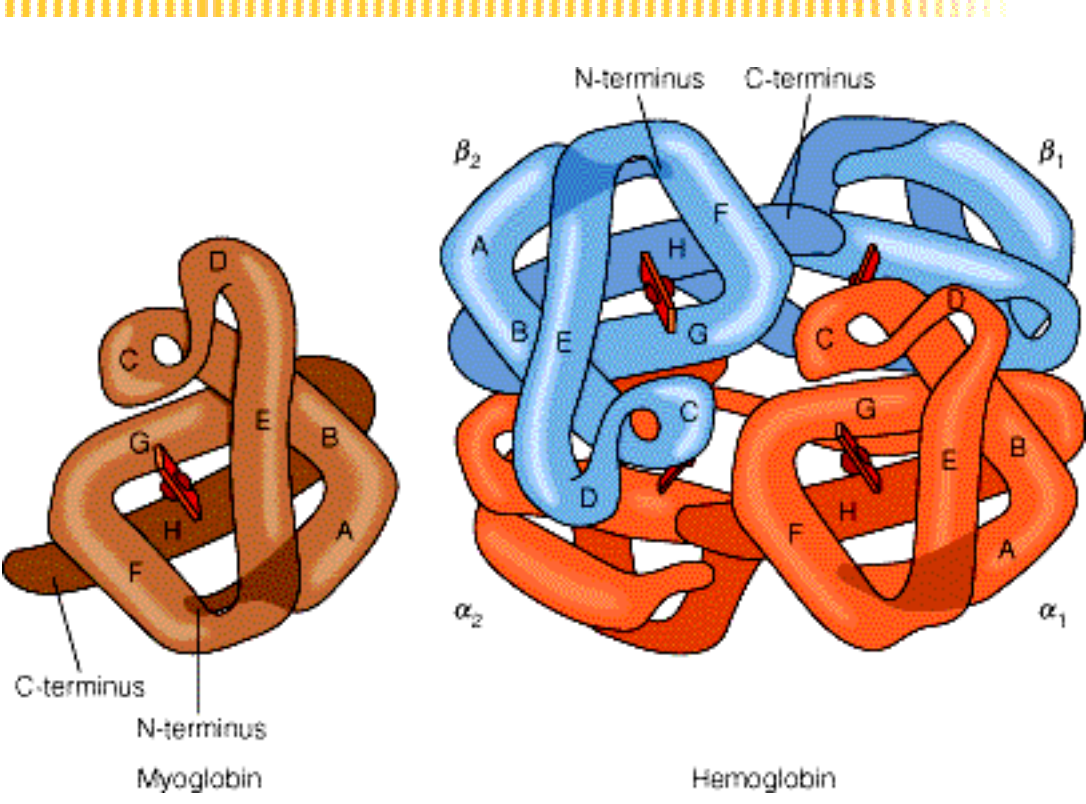

© Irving Geis.

Figure 6.1: Three-dimensional folding of the protein myoglobin.

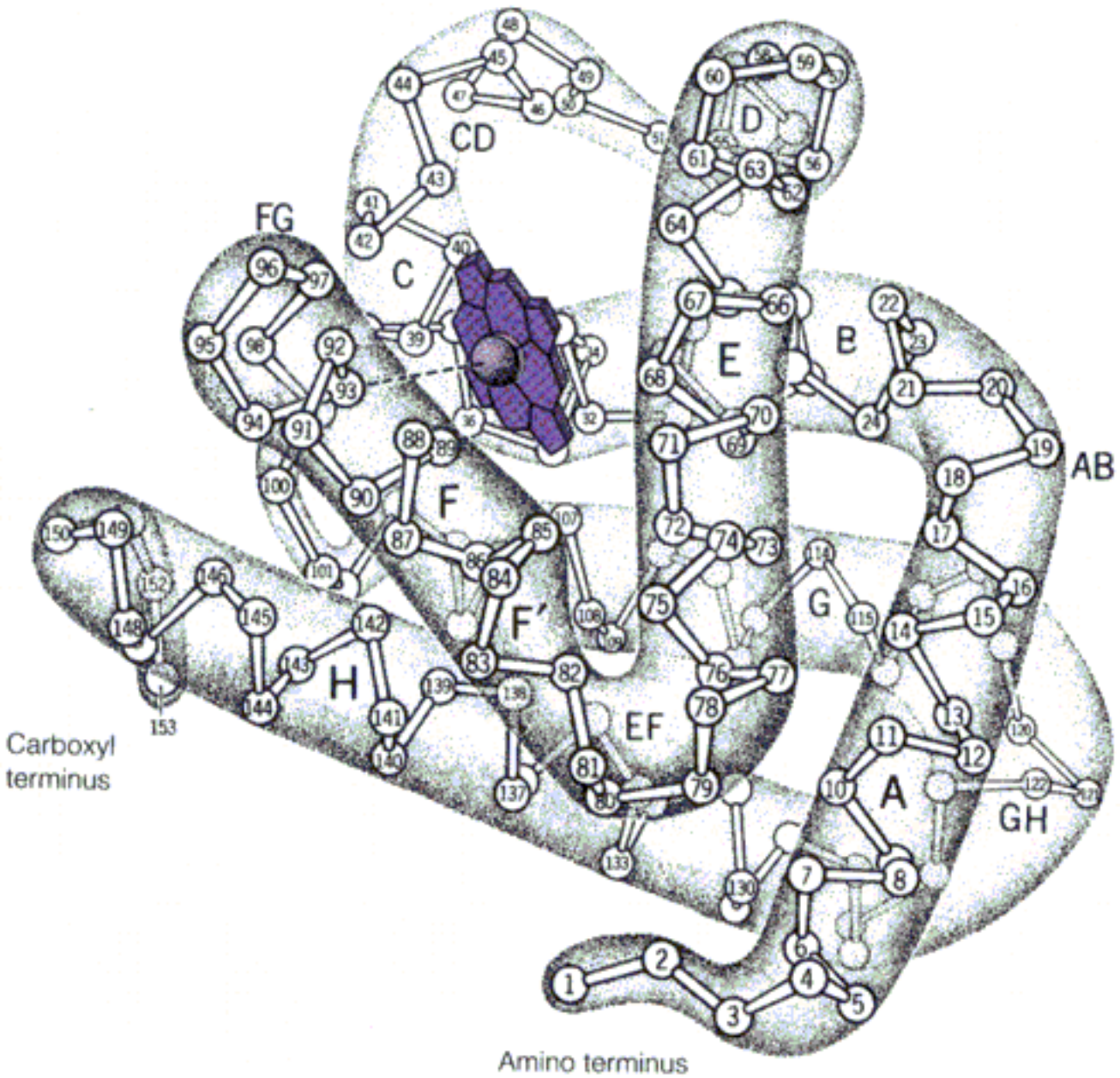

© Irving Geis.

Oxygen Binding by Heme Proteins

Myoglobin/Hemoglobin Structure - The myoglobin-hemoglobin family of proteins employs Fe(II) for O₂ binding. Throughout the myoglobin-hemoglobin family, the iron is chelated by a tetrapyrrole ring system called protoporphyrin IX, one of a large class of porphyrin compounds. The basic ring structure of a porphyrin is shown in [Figure 7.4a](#), and protoporphyrin IX is shown in [Figure 7.4b](#). Other porphyrins include [chlorophyll](#), the [cytochrome](#) proteins, and some natural pigments. The iron-porphyrin in hemoglobin accounts for the red color of blood, and the magnesium-porphyrin in chlorophyll is responsible for the green of plants.

The complex of protoporphyrin IX with Fe(II) is called [heme](#) ([Figure 7.4c](#)). This prosthetic group is noncovalently bonded in a hydrophobic crevice in the [myoglobin](#) or [hemoglobin](#) molecule (see [Figure 7.3](#)). The binding of oxygen to heme is illustrated in [Figure 7.5](#), which shows the oxygenated form of myoglobin.

Geometry of Fe Linkage - Fe(II) is normally octahedrally coordinated, which means it usually has six ligands, or binding groups, attached to it. As shown in [Figure 7.5a](#), the nitrogen atoms of the porphyrin ring account for four ligands. Two remaining coordination sites lie along an axis perpendicular to the plane of the porphyrin ring. In both the deoxygenated and the oxygenated forms of myoglobin, one site is occupied by the nitrogen of [histidine](#) residue number 93. The eight helical segments in myoglobin and each of the four subunits of hemoglobin are called A through H (as shown in [Figure 6.1](#)), and residue 93 is located in the F helix ([Figure 7.5b](#)). In the nomenclature often employed, this residue is called histidine F8. Because it is in direct contact with the Fe atom, it is also called the proximal histidine. In deoxymyoglobin, the remaining coordination site, on the other side of the iron, is occupied by a water molecule. When oxygen is bound, making oxymyoglobin, O₂ displaces the water molecule. On the other side of the bound O₂ lies histidine residue 64, or E7, also called the distal histidine. An almost identical mode of oxygen binding is found in each subunit of hemoglobin.

Oxygen/Oxidation - If myoglobin or hemoglobin is stored in air, outside the cellular environment, their Fe(II) slowly oxidizes to Fe(III), forming metmyoglobin or methemoglobin. Neither metmyoglobin nor methemoglobin can bind oxygen. This oxidation is not unexpected. In fact, an oxygen molecule in such close contact with a ferrous [Fe(II)] ion would be expected to convert the latter to the ferric [Fe(III)] state. In the cell, in the hydrophobic, protected environment in the interior of myoglobin or hemoglobin, however, a temporary electron rearrangement occurs upon binding of oxygen, preventing the oxidation of iron. When the oxygen is released, the iron remains in the Fe(II) state, able to bind another O₂. Protection of the oxygen-binding Fe(II) from irreversible oxidation is the functional reason for the existence of myoglobin and hemoglobin. That is, the secondary and tertiary structures of these two molecules provide environments in which the first step of an oxidation reaction (the binding of oxygen) is permitted, but the final step (oxidation) is blocked.

Toxicity of Carbon Monoxide - The heme pocket can bind some other small molecules besides O₂.

The most physiologically important one is carbon monoxide (CO), which is approximately the same size and shape as O₂. However, CO is bound with much greater affinity to myoglobin and hemoglobin than is O₂, and the binding is not readily reversible. This is why CO is such a toxic gas - it ties up oxygen binding sites and thereby blocks respiration.

See also: [Oxygen Binding by Myoglobin](#), [Oxygen Binding by Hemoglobin](#), [Models of Allosteric Activity](#), [Histidine](#)

Chlorophyll

To capture the available light energy, photosynthetic organisms have evolved a set of pigments that efficiently absorb visible and near-infrared light. These pigments are sometimes referred to as chromophores - compounds that absorb light of specific wavelength. Structures of a few of the most important photosynthetic chromophores are shown in [Figure 17.7](#).

Chlorophyll and some of the accessory pigments are contained in the [thylakoid membranes](#) of the [chloroplast](#). The assemblies of light-harvesting pigments in the thylakoid membrane, together with their associated proteins, are organized into well-defined photosystems, structural units dedicated to the task of absorbing light photons and recovering some of their energy in a chemical form. The first part of this process takes place in what are referred to as light-harvesting complexes. Each is a multisubunit protein complex containing multiple antenna pigment molecules (**chlorophylls** and some accessory pigments) and a pair of **chlorophyll** molecules that act as the reaction center, trapping energy quanta excited by the absorption of light.

Most of the **chlorophyll** molecules are not directly engaged in the photochemical process itself but act, instead, as antenna molecules of the light-harvesting complexes. Antenna molecules absorb photons, and the energy is passed by resonance transfer to specific **chlorophyll** molecules in a relatively few reaction centers. In other words, the energy of a photon absorbed by any antenna molecule in a photosystem wanders about the system randomly ([Figure 17.11](#)). Eventually (meaning in about 10^{-10} s), the energy finds its way to a **chlorophyll** molecule in the reaction center. This molecule is like the other **chlorophylls**, but it is in a somewhat different environment, so that its excited state energy level is a bit lower. Thus, it acts as a trap for quanta of energy absorbed by any of the other pigment molecules. It is the excitation of this reaction center that begins the actual photochemistry of the light reactions, for it starts a series of electron transfers.

See also: [Chlorophyll a](#), [Chlorophyll b](#), [Light-Harvesting Complexes](#), [Reaction Center](#), [Chloroplast Anatomy](#), [Phytanic Acid](#), [Porphyrin and Heme Metabolism](#)

INTERNET LINKS:

1. [Porphyrin and Chlorophyll Metabolism](#)
 2. [Photosynthetic Pigments](#)
-

Figure 17.7: Some photosynthetic pigments.

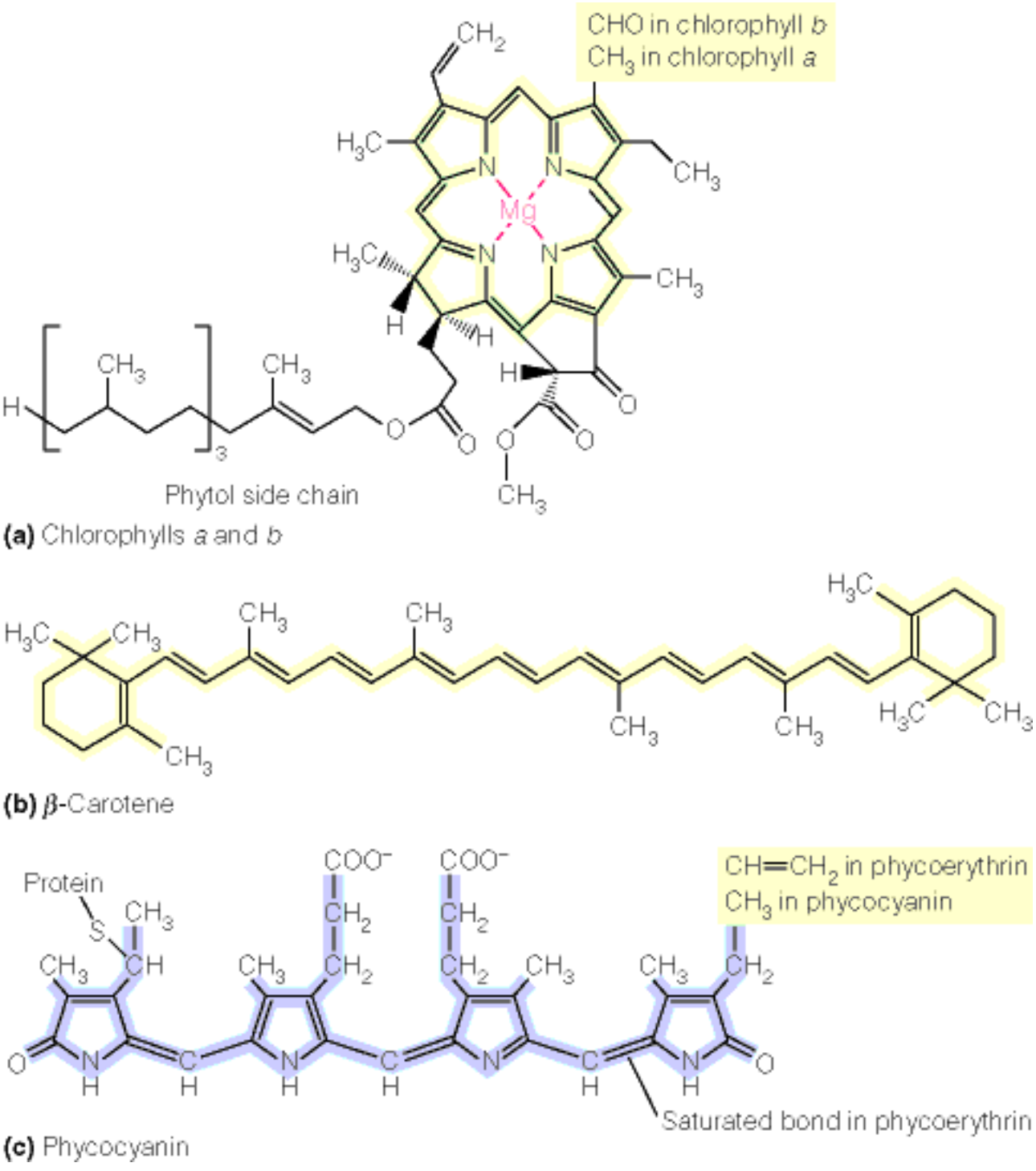

Thylakoid Membrane

The **thylakoid membrane** is a structure of the chloroplast that is equivalent to the mitochondrial inner membrane ([Figure 15.2a](#)). The term **thylakoid** is sometimes used interchangeably with **thylakoid membrane**. Absorption of light and all of the light reactions occur within or on the **thylakoid membranes**. [Figure 17.15](#) summarizes the light reactions that occur in the **thylakoid membrane**. The CF0-CF1 complex that is equivalent to the mitochondrial F0F1 ATP synthase complex and is located in the thylakoid membranes as are the two photosystems (I and II) and associated electron carriers. The **thylakoid membrane** provides the walls surrounding the thylakoid lumen into which protons are pumped during photosynthesis.

See also: [Figure 17.4c](#), [Figure 17.16](#), [Thylakoid Lumen](#), [Chloroplast Anatomy](#), [Stroma](#), [CF0-CF1 Complex](#), [Chloroplast Anatomy](#), [Grana](#), [Stroma](#), [Mitochondrial Structure and Function](#), [Photosystem II](#), [Photosystem I](#), [CF0-CF1 Complex](#)

Figure 17.15: Summary view of the light reactions as they occur in the thylakoid.

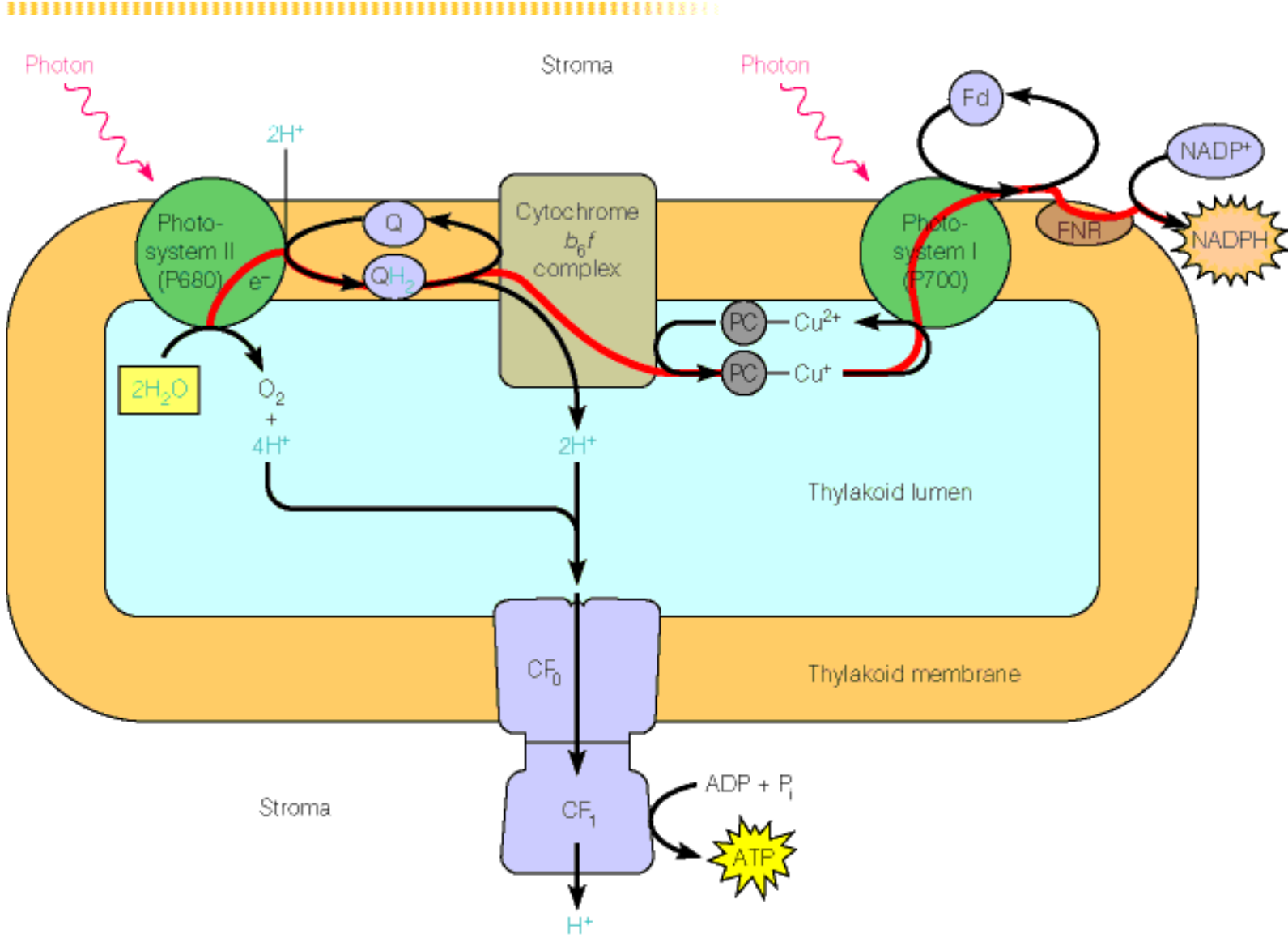
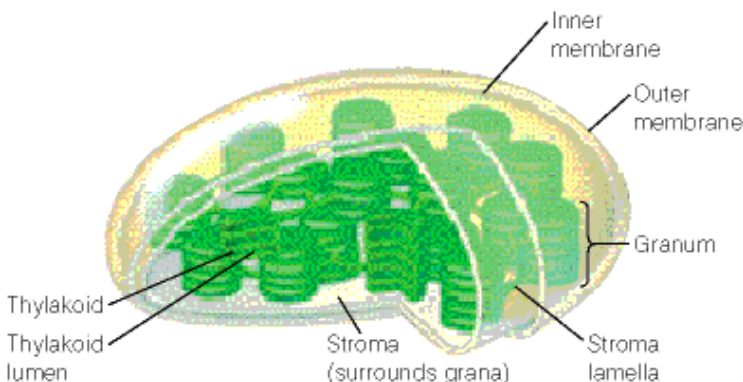

Figure 17.4c: Chloroplasts, the photosynthetic organelles of green plants and algae.



(e)

From Neil Campbell, Jane Reece, and Larry Mitchell, *Biology*, 5th ed. (Menlo Park, CA: Addison Wesley Longman, 1999). © Addison Wesley Longman, Inc.

Figure 17.16: Arrangement of components of the two photosystems on the thylakoid membrane.

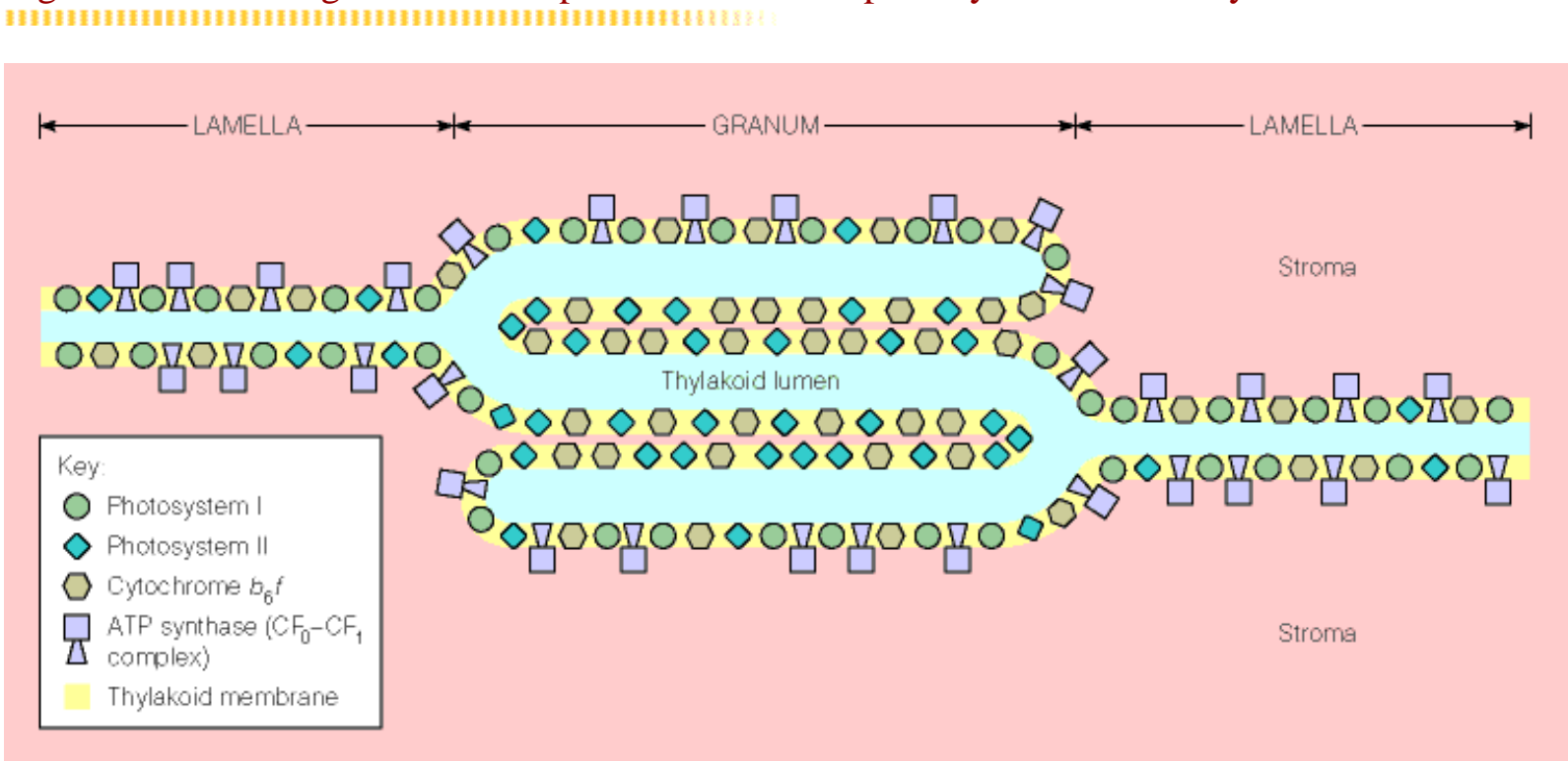

Thylakoid Lumen

The **thylakoid lumen** is the part of the chloroplast enclosed by the thylakoid membrane ([Figure 17.15](#)). During photosynthesis, electrons are pumped into the **thylakoid lumen** from the stroma, forming a proton gradient. Movement of the protons out of the **thylakoid lumen** through the CF₀-CF₁ complex back to the stroma provides the driving force for photophosphorylation, the process of making ATP in photosynthesis. A similar mechanism is responsible for ATP synthesis in oxidative phosphorylation.

See also: [Thylakoid Membrane](#), [Figure 17.4c](#), [The Chloroplast](#), [Chloroplast Anatomy](#), [Stroma](#), [Grana](#), [CF₀-CF₁ Complex](#), [Figure 17.16](#), [Oxidative Phosphorylation](#)

The Chloroplast

The **chloroplast**, a plant organelle, is the site of photosynthesis in higher plants and algae. Like mitochondria, **chloroplasts** carry their own DNA to code for some of their proteins, as well as the ribosomes necessary for translation of the appropriate mRNAs. **Chloroplasts** may have evolved from cyanobacteria, which have membrane structures like **chloroplast** membranes.

The internal structure of **chloroplasts** ([Figure 17.4c](#)) resembles that of the [mitochondrion](#) (see [here](#)). Note the presence of an outer, relatively permeable membrane and an inner membrane that is selectively permeable. The [stroma](#) of the **chloroplast** is analogous to the mitochondrial matrix. Immersed in the stroma are many flat, saclike membrane structures called [thylakoids](#) which are stacked like coins. The stacks are called [grana](#). Grana are irregularly interconnected by thylakoid extensions called stroma lamellae. The thylakoid membrane encloses the lumen (or interior) of the thylakoid.

There are analogies in structure and role between the mitochondrial matrix ([Figure 15.2a](#)) and the **chloroplast** stroma and also between the inner membrane of the mitochondrion and the thylakoid membrane of the chloroplast. Absorption of light and all of the light reactions occur within or on the thylakoid membranes. ATP and NADPH produced by these reactions are released into the surrounding stroma, where the synthetic dark reactions occur.

See also: [Mitochondrial Structure and Function](#) (from Chapter 15), [Basic Processes of Photosynthesis](#), [Light Gathering Structures](#), [Chloroplast Anatomy](#), [Thylakoid Lumen](#), [Chlorophyll](#), [Chloroplasts](#)

Figure 1.13: Distribution of biomolecules in a cell.

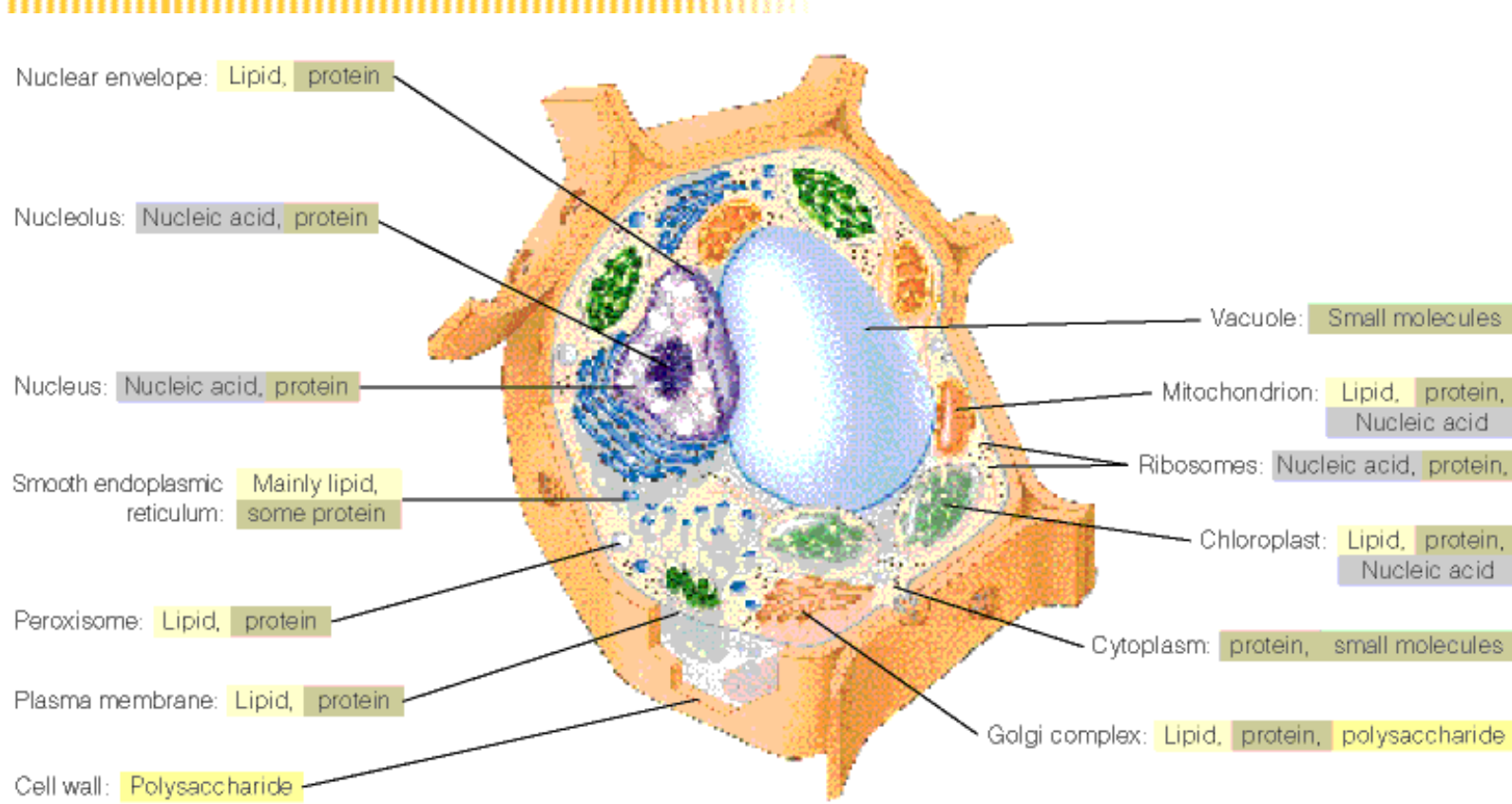

From Neil Campbell, Jane Reece, and Larry Mitchell, *Biology*, 5th ed. (Menlo Park, CA: Addison Wesley Longman, 1999)
© Addison Wesley Longman, Inc.

Mitochondrial Structure and Function

Metabolic oxidations generate reduced electron carriers, such as [NADH](#) and [FADH₂](#). Oxidation of these electron carriers in the mitochondrion generates most of the energy needed for ATP synthesis. Most vertebrate cells contain several hundred mitochondria, but the number can be as low as 1 and as high as 100,000.

[Figure 15.2a](#) schematically illustrates mitochondrial structure. Note that it has an outer membrane, an inner membrane, an intermembrane space, and a matrix, located within the inner membrane. The outer membrane is porous, whereas the inner membrane is much tighter, serving as a barrier to many biological metabolites. Note, too, that the inner membrane is highly folded into cristae, which project into, and often nearly through the interior of the mitochondrion. Understanding the function of the inner mitochondrial membrane is a key to understanding how the mitochondrion works.

Processes occurring inside the mitochondrial matrix include [pyruvate oxidation](#), [fatty acid oxidation](#), [amino acid metabolism](#), and the [citric acid cycle](#). Furthermore, respiratory proteins are bound to the inner membrane, so the density of cristae corresponds to the respiratory activity of a cell. For example, mitochondria in heart muscle cells (high rates of respiration) are densely packed with cristae, whereas mitochondria in liver cells (low rates of respiration) have more sparsely distributed cristae.

Embedded within the inner membrane are the protein electron carriers (primarily) cytochromes, which constitute the respiratory chain. They are assembled in the form of five multiprotein complexes, named I, II, III, IV, and V. Smaller carriers, such as coenzyme Q and cytochrome c, also participate in carrying electrons. [Figure 15.2b](#) shows metabolic reactions occurring inside the mitochondrial matrix and movement of electrons through the complexes in the inner mitochondrial membrane. Note that electrons are ultimately donated with protons to oxygen to form water and that Complex V does not function in transport of electrons.

See also: [Electron Transport](#), [Integrity of Mitochondrial Membranes](#)

INTERNET LINK: [Electron Transport Animation](#)

Pyruvate Oxidation

One source of acetyl-CoA molecules for the citric acid cycle is via oxidation of pyruvate in a reaction catalyzed by the **pyruvate dehydrogenase complex**. The process of converting pyruvate to acetyl-CoA is an oxidative decarboxylation. In the overall reaction (below), the carboxyl group of pyruvate is lost as CO₂, while the remaining two carbons form the acetyl moiety of acetyl-CoA.



This reaction involves electron transfer to make NADH, decarboxylation of pyruvate, and formation of acetyl-CoA, an activated two carbon compound. In yeast, **acetaldehyde** is formed by pyruvate decarboxylase, which is subsequently converted to ethanol by action of the enzyme **alcohol dehydrogenase**.

Enzymatic activities contained in the pyruvate dehydrogenase complex include:

- **Pyruvate decarboxylase (E1)**
- **Dihydrolipoamide transacetylase (E2)**
- **Dihydrolipoamide dehydrogenase (E3)**

and five coenzymes

- **Thiamine Pyrophosphate (TPP)**
- **Lipoic Acid-Lipoamide**
- **FAD**
- **NAD⁺**
- **CoASH**

All of these entities together make up the pyruvate dehydrogenase complex. An overview of the process is shown in **Figure 14.4** and the reaction mechanism is shown in **Figure 14.10**. In summary, reaction steps are as follows:

1. E1 accepts a two carbon aldehyde from the decarboxylation of pyruvate.
2. The aldehyde group is transferred to the first lipoamide arm of E2 and is oxidized to an acetyl group.
3. The acetyl group is transferred to the second lipoamide arm of E2.

4. The acetyl group is linked to CoASH, forming acetyl-CoA.

5. E3 oxidizes the reduced lipoamide arm by transferring two hydrogens to FAD, forming FADH₂

6. FADH₂ is oxidized by NAD⁺, forming FAD and NADH + H⁺.

Decarboxylation of α -**ketoglutarate** by the α -ketoglutarate dehydrogenase complex (**AKGDH**) involves very similar reactions with the same coenzymes in a complex arrangement very much like the pyruvate dehydrogenase complex.

Allosteric Regulation

Pyruvate dehydrogenase is a major regulatory point for entry of materials into the citric acid cycle.. The enzyme is regulated allosterically and by covalent modification.

E2 - inhibited by acetyl-CoA, activated by CoA-SH

E3 - inhibited by NADH, activated by NAD⁺.

ATP is an allosteric inhibitor of the complex, and AMP is an activator. The activity of this key reaction is coordinated with the energy charge, the [NAD⁺]/[NADH] ratio, and the ratio of acetylated to free coenzyme A.

Covalent Regulation

Part of the **pyruvate dehydrogenase complex**, pyruvate dehydrogenase kinase, phosphorylates three specific E1 serine residues, resulting in loss of activity of pyruvate dehydrogenase. NADH and acetyl-CoA both activate the kinase. The serines are dephosphorylated by a specific enzyme called pyruvate dehydrogenase phosphatase that hydrolyzes the phosphates from the E1 subunit of the **pyruvate dehydrogenase complex**. This has the effect of activating the complex. The phosphatase is activated by Ca²⁺ and Mg²⁺. Because ATP and ADP differ in their affinities for Mg²⁺, the concentration of free Mg²⁺ reflects the ATP/ADP ratio within the mitochondrion. Thus, pyruvate dehydrogenase responds to ATP levels by being turned off when ATP is abundant and further energy production is unneeded.

In mammalian tissues at rest, much less than half of the total pyruvate dehydrogenase is in the active, nonphosphorylated form. The complex can be turned on when low ATP levels signal a need to generate more ATP. The kinase protein is an integral part of the pyruvate dehydrogenase complex, whereas the phosphatase is but loosely bound.

See also: [Pyruvate Dehydrogenase Kinase](#), [Pyruvate Dehydrogenase Phosphatase](#)

INTERNET LINK: [α-Keto Acid Complexes - A Review](#)

Pyruvate Dehydrogenase Complex

One source of [acetyl-CoA](#) molecules for the citric acid cycle is oxidative decarboxylation of pyruvate, catalyzed by the **pyruvate dehydrogenase complex**. The complex is composed of three enzymes

1. [Pyruvate decarboxylase](#) (E1)
2. [Dihydrolipoamide transacetylase](#) (E2)
3. [Dihydrolipoamide dehydrogenase](#) (E3)

and five coenzymes

1. [Thiamine Pyrophosphate](#) (TPP)
2. [Lipoic Acid](#) - [lipoamide](#)
3. [FAD](#)
4. [NAD⁺](#)
5. [CoASH](#)

The reaction mechanism is described here and is depicted in [Figure 14.10](#).

The **pyruvate dehydrogenase complex** resembles the α -ketoglutarate dehydrogenase complex ([AKGDH](#)). The three enzyme activities are analogous and the five coenzymes are the same. The pyruvate dehydrogenase complex also catalyzes a similar reaction - oxidative decarboxylation of an α -keto acid. The **pyruvate dehydrogenase complex** differs from the AKGDH in being regulated allosterically and controlled via covalent modification.

See also: [Pyruvate Oxidation](#), [Pyruvate Dehydrogenase Complex Regulation](#)

INTERNET LINK: [\$\alpha\$ -Keto Acid Complexes - A Review](#)

Pyruvate Decarboxylase (E1)

Pyruvate decarboxylase is a part of the [pyruvate dehydrogenase complex](#) in higher organisms where it is referred to as **E1**. 24 copies of it are found in the *Azotobacter* complex along with two other enzymatic activities, referred to as [E2](#) and [E3](#).

Pyruvate decarboxylase uses [thiamine pyrophosphate](#) as a coenzyme and catalyzes the decarboxylation of [pyruvate](#). This decarboxylated product has two fates. In yeast, [acetaldehyde](#) is formed, which is subsequently converted to ethanol by action of the enzyme [alcohol dehydrogenase](#). In non-fermentative reactions, [acetyl-CoA](#) is formed.

See also: [Pyruvate Oxidation](#), [Coenzymes](#)

INTERNET LINKS:

1. [Glycolysis/Citric Acid Cycles](#)
 2. [\$\alpha\$ -Keto Acid Complexes - A Review](#)
-

Dihydrolipoamide Transacetylase (E2)

E2 is a catalytic activity found in the pyruvate dehydrogenase complex. It forms the core of the complex. 24 copies of **E2** are found in the complex isolated from *Azotobacter*. **E2** is covalently bound to lipoic acid, forming lipoamide. Lipoamide functions to oxidize the aldehyde moiety transferred to it from E1 to an acetyl group and to subsequently transfer it to coenzyme A, forming acetyl-CoA. Electrons from E2 are, in turn, passed to FAD, in a reaction catalyzed by E3.

See also: [Pyruvate Dehydrogenase Complex](#), [E1](#), [E3](#), [Lipoic Acid](#), [Coenzyme A](#), [Regulation of the Pyruvate Dehydrogenase Complex](#)

INTERNET LINK: [α-Keto Acid Complexes - A Review](#)

Pyruvate Decarboxylase

Pyruvate decarboxylase is found as part of the pyruvate dehydrogenase complex in higher organisms where it is referred to as **E1**. 24 copies of it are found in the Azotobacter complex along with two other enzymatic activities, referred to as E2 and E3.

Pyruvate decarboxylase is also part of the pathway involved in alcoholic fermentation in yeast. In the reaction, pyruvate is converted to acetaldehyde, which is subsequently converted to ethanol by action of the enzyme alcohol dehydrogenase:



Pyruvate decarboxylase uses **thiamine pyrophosphate** as a coenzyme.

See also: [Pyruvate Dehydrogenase Complex](#), [Alcoholic Fermentation](#), [Alcohol Dehydrogenase](#)

Thiamine Pyrophosphate (TPP)

TPP is used as a coenzyme for all decarboxylations of α -keto acids. It is derived from [thiamine](#) (Vitamin B1) by transfer of a pyrophosphate group from [ATP](#) to thiamine, yielding **TPP** and [AMP](#).

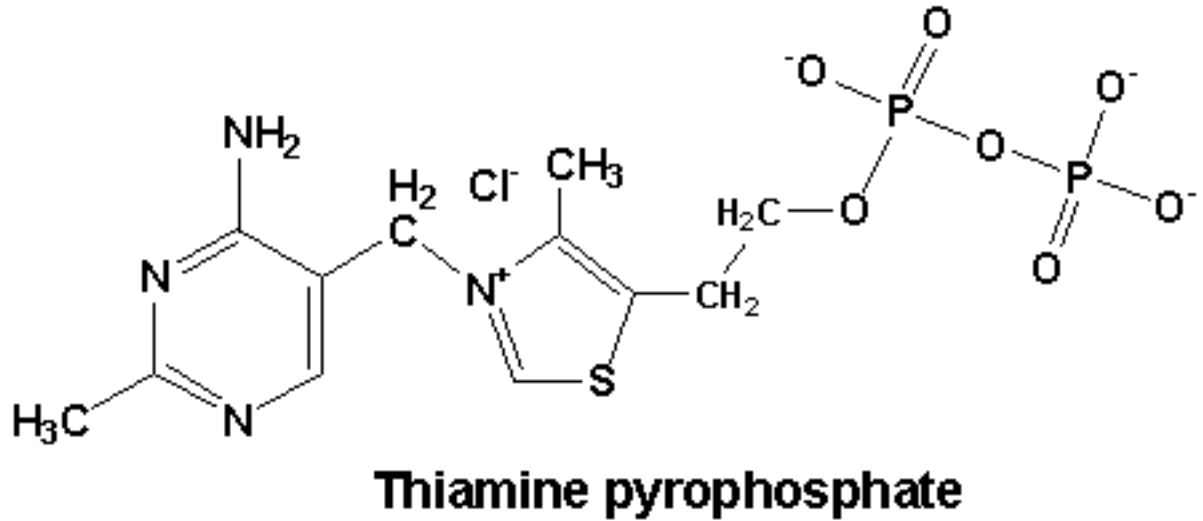

Mechanism of action - **TPP** contains two heterocyclic rings, a substituted pyrimidine and a thiazole. The latter is the reactive moiety - specifically, the rather acidic carbon between the sulfur and the nitrogen. this carbon forms a carbanion (step 1 in [Figure 14.6](#)), which in turn, can attack the carbonyl carbon of α -keto acids, such as [pyruvate](#), giving an addition compound (step 2 in [Figure 14.6](#)). This compound undergoes nonoxidative decarboxylation (step 3 in [Figure 14.6](#)), with the thiazole ring acting as an electron sink in forming a resonance-stabilized ene-amine. Protonation (step 4 in [Figure 14.6](#)) gives a species called active acetaldehyde, or, more accurately, hydroxyethyl-**TPP**.

In the fermentation of glucose to ethanol in yeast (step 5 in [Figure 14.6](#)), this intermediate undergoes an elimination reaction to yield [acetaldehyde](#) and the **TPP** carbanion. In the pyruvate dehydrogenase reaction (not shown), the activated two-carbon fragment is simultaneously oxidized and transferred to another enzyme, as discussed in the section on lipoic acid. Thus, in general terms, **TPP** functions in the generation of an activated aldehyde species, which may or may not undergo oxidation as it is transferred to an acceptor.

Some enzymes that use **TPP** include pyruvate decarboxylase, pyruvate dehydrogenase, branched chain α -keto acid dehydrogenase, α -keto glutarate dehydrogenase, transketolase.

See also: [Thiamine Pyrophosphate and Decarboxylations](#), [Lipoic Acid](#), [Ethanol Fermentation](#), [Pyruvate Dehydrogenase](#), [Pyruvate Decarboxylase](#), [Acetaldehyde](#), α [Ketoglutarate Dehydrogenase](#)

INTERNET LINKS:

1. [\$\alpha\$ -Keto Acid Complexes - A Review](#)

2. Thiamine Metabolism

>Thiamine (Vitamin B

Thiamine is Vitamin B1.

Addition of a pyrophosphate to **thiamine** (from ATP) converts it to thiamine pyrophosphate, a molecule that is the coenzyme for all decarboxylations of α -keto acids.

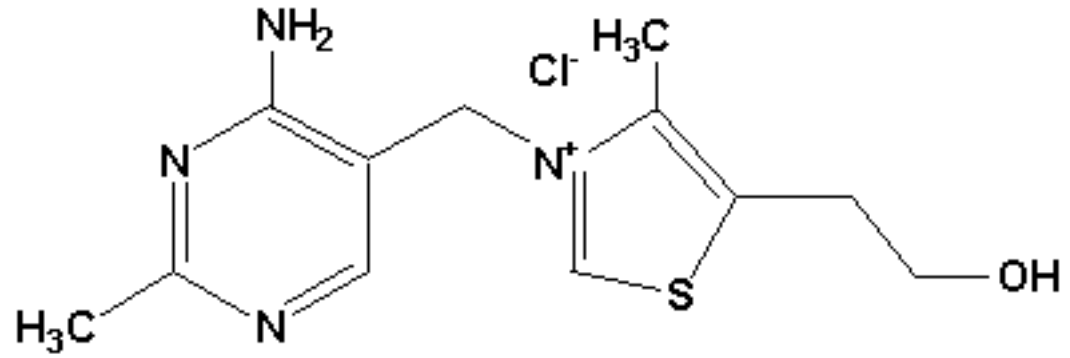

Vitamin B1 (Thiamine)

See also: [Thiamine](#)

[Pyrophosphate](#), [Pyruvate Oxidation](#), [Pyruvate Decarboxylation Complex](#), [Diagram](#)

INTERNET LINK: [Thiamine Metabolism](#)

Unnumbered Item

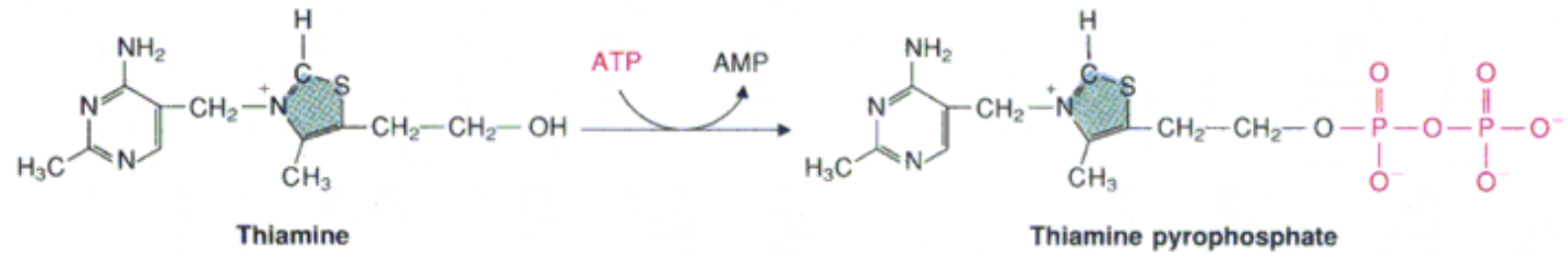
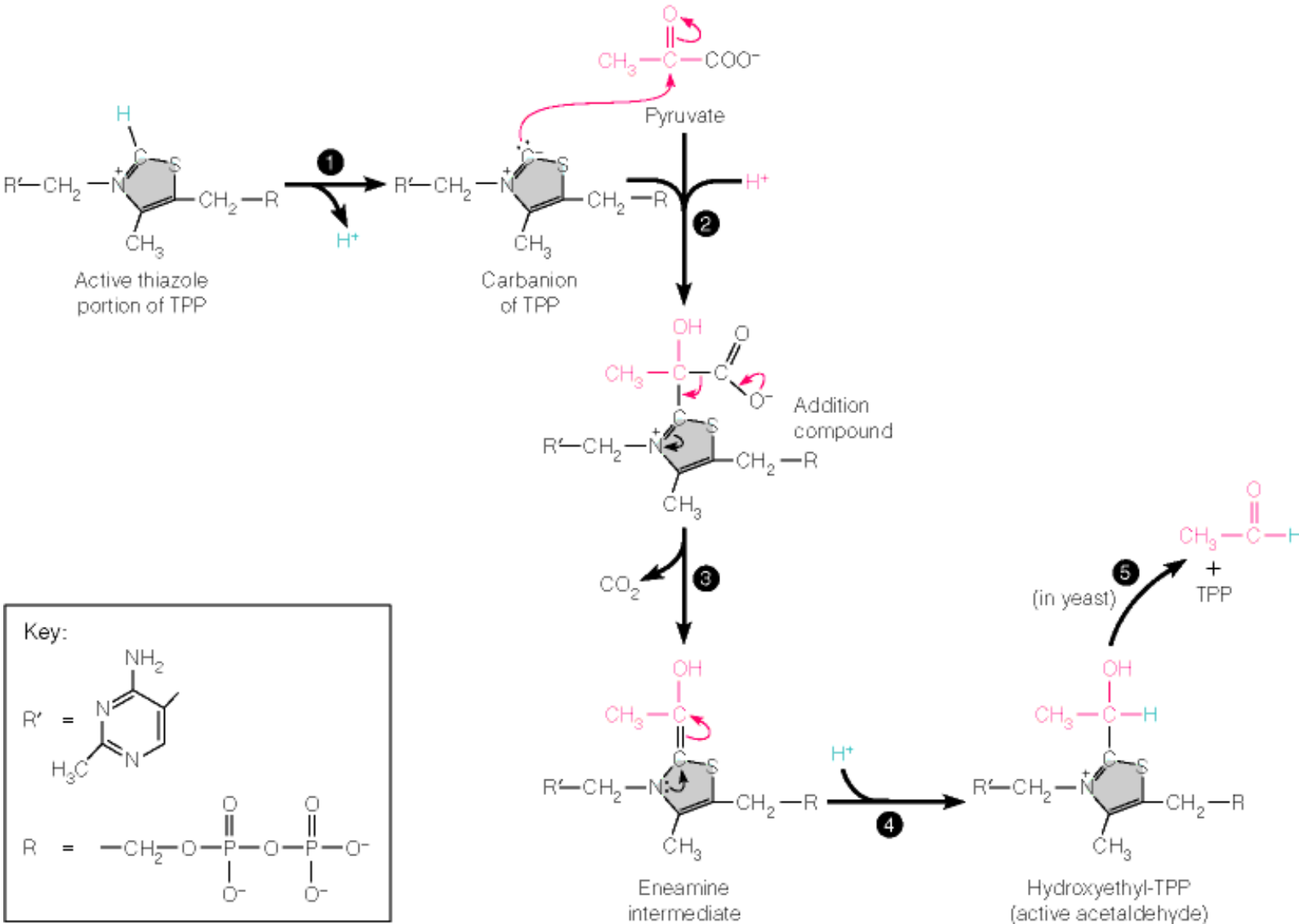

Figure 14.6: Thiamine pyrophosphate in the pyruvate dehydrogenase reaction.



Thiamine Pyrophosphate and Decarboxylations

Thiamine pyrophosphate (TPP) is derived from [thiamine](#) (vitamin B1) via an ATP-dependent pyrophosphorylation. TPP is the coenzyme for all decarboxylations of α -keto acids. Steps in the process are depicted in [Figure 14.6](#), summarized below.

1. Carbanion formation on the thiazole portion of **TPP**.
2. Carbanion attack on the carbonyl-carbon of α -keto acids to yield an addition compound. In [Figure 14.6](#), the α -keto acid is [pyruvate](#).
3. Decarboxylation of the addition compound with the thiazole ring acting as an electron sink in forming a resonance-stabilized enamine.
4. Protonation of the enamine to form an active acetaldehyde called hydroxyethyl-**TPP**.
5. The active acetaldehyde can then be oxidized (as in the pyruvate dehydrogenase and α -ketoglutarate dehydrogenase complexes) or an elimination reaction (non-oxidative) can occur. In either case, the decarboxylated compound is released, yielding free **TPP**.

Thus, **TPP** functions to form an activated aldehyde species which may or may not be subsequently oxidized.

See also: [Thiamine Pyrophosphate](#), [Pyruvate Dehydrogenase Complex](#), [\$\alpha\$ -Ketoglutarate Dehydrogenase Complex](#)

L-Methylmalonyl-CoA Mutase

Methylmalonyl-CoA mutase catalyzes the conversion of L-methylmalonyl-coA to succinyl-CoA.



This reaction is important in the metabolism of propionyl-CoA, which arises from oxidation of odd-numbered chains of fatty acids.

Methylmalonyl-CoA mutase is an unusual vitamin B12-containing enzyme.

See also: [Oxidation of Odd-Numbered Fatty Acids](#), [Propionyl-CoA](#), [Vitamin B12](#)

Methylmalonyl-CoA

Methylmalonyl-CoA is present biologically in both the D and L isomers, which can be interconverted by the enzyme **methylmalonyl-CoA epimerase** (**Figure 18.19**). This reaction is important in the metabolism of **propionyl-CoA**, which arises from oxidation of odd-numbered chains of fatty acids. **L-methylmalonyl-CoA** is further acted upon by **methylmalonyl-CoA mutase**.

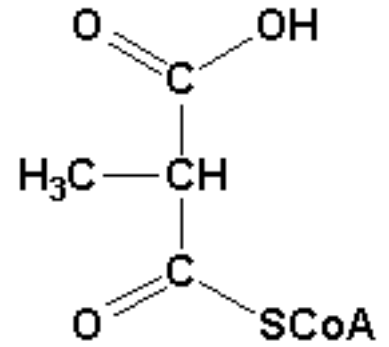

Methylmalonyl-CoA

See also: **Methylmalonyl-CoA Epimerase** **Propionyl-CoA Carboxylase**, **Oxidation of Odd-Numbered Fatty Acids**,

Methylmalonyl-CoA Epimerase

Methylmalonyl-CoA epimerase catalyzes the interconversion of the D and L isomers of methylmalonyl-CoA. This reaction is an important part of metabolism of **propionyl-CoA**, which arises from oxidation of odd-numbered fatty acids.

D-Methylmalonyl-CoA \rightleftharpoons **L-Methylmalonyl-CoA** (catalyzed by **Methylmalonyl-CoA Epimerase**)

See also: [Oxidation of Odd-Numbered Fatty Acids](#)

Propionyl-CoA

Propionyl-CoA is produced as an intermediate of odd chain fatty acid oxidation. **Propionyl-CoA** is produced by thiolytic cleavage of the five-carbon homolog of acetoacetyl-CoA (see [here](#)).

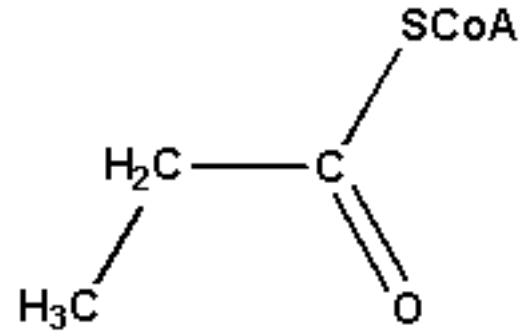

Propionyl-CoA

Propionyl-CoA can be converted to D-[Methylmalonyl-CoA](#) by the enzyme [propionyl-CoA carboxylase](#) via addition of a carboxyl group (from bicarbonate) in the presence of [ATP](#) (Figure [18.19](#)).

See also: [Oxidation of Odd-Numbered Fatty Acids](#), [Methylmalonyl-CoA](#), [Propionyl-CoA Carboxylase](#)

Unnumbered Item

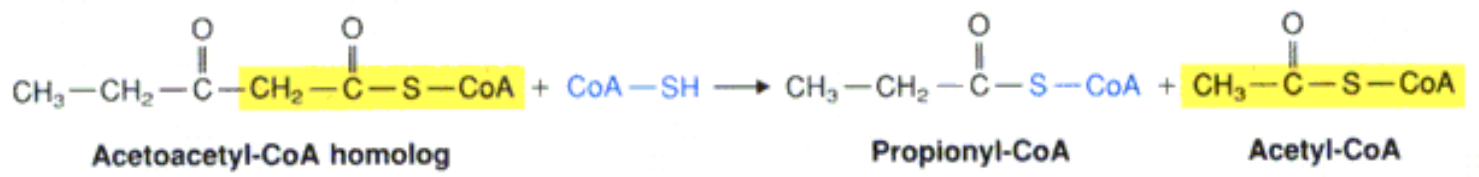

Propionyl-CoA Carboxylase

Propionyl-CoA carboxylase catalyzes the carboxylation of propionyl-CoA to form D-methylmalonyl-CoA in propionic acid metabolism, as shown in the reaction that follows:



See also: [Oxidation of Odd-Numbered Fatty Acids](#)

Oxidation of Odd-Numbered Fatty Acids

Most **fatty acids** in the body contain an even number of carbons. The normal end-products of β -oxidation of these compounds are all acetyl-CoA. β -oxidation of **fatty acids** containing an odd number of carbons yields a propionyl-CoA in the last step. Propionyl-CoA cannot be used directly in the citric acid cycle. Instead, it is converted, in the following reactions ([Figure 18.19](#)), to succinyl-CoA.

1. [Propionyl-CoA](#) + ATP + HCO₃⁻ \rightleftharpoons [D-Methylmalonyl-CoA](#) + ADP + Pi (catalyzed by [Propionyl-CoA Carboxylase](#))
2. [D-Methylmalonyl-CoA](#) \rightleftharpoons [L-Methylmalonyl-CoA](#) (catalyzed by [Methylmalonyl-CoA Epimerase](#))
3. [D-Methylmalonyl-CoA](#) \rightleftharpoons [Succinyl-CoA](#) (catalyzed by [Methylmalonyl-CoA Mutase](#))

Methylmalonyl-CoA mutase, the catalyst for the third reaction in this process, requires vitamin B12 as a cofactor. The inability to catabolize propionyl-CoA properly has severe consequences in humans. Severe acidosis results, lowering blood pH and damaging the central nervous system.

See also: [\$\beta\$ -Oxidation](#), [Acetyl-CoA](#), [Citric Acid Cycle Reactions](#), [Vitamin B12](#)

Figure 18.19: Pathway for catabolism of propionyl-CoA.

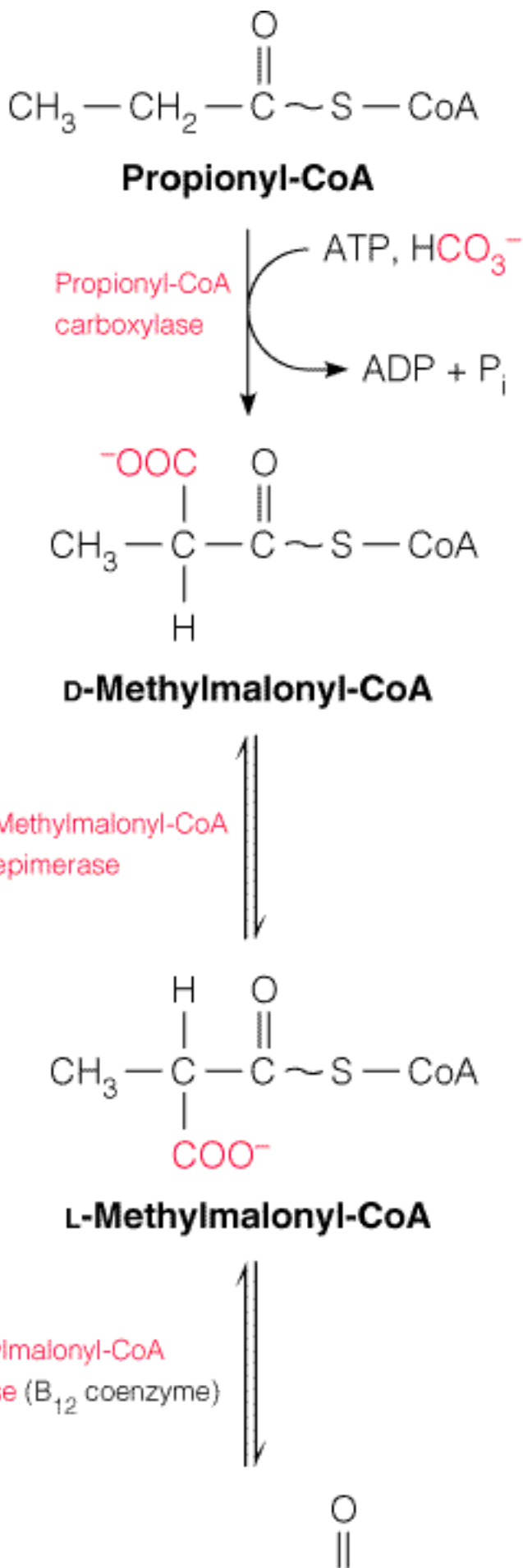

IV

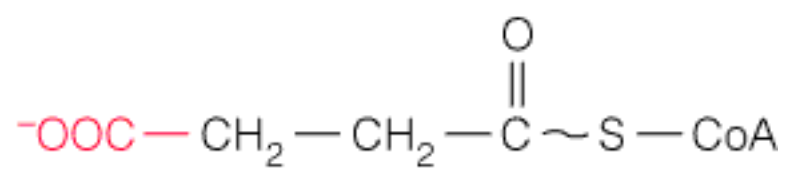

Succinyl-CoA

Vitamin B

The metal cobalt in **vitamin B12** is coordinated with a tetrapyrrole ring system, called a corrin ring, which is similar to the porphyrin ring of **heme** compounds. The cyanide attached to the cobalt in the structure is an artifact of the isolation and is replaced by water or a hydroxyl group in cells. The presence of cobalt and amide nitrogens gives **B12** compounds the name cobamides or cobalamins. About 15 different **B12**-requiring reactions are known, most of which occur in a few bacterial

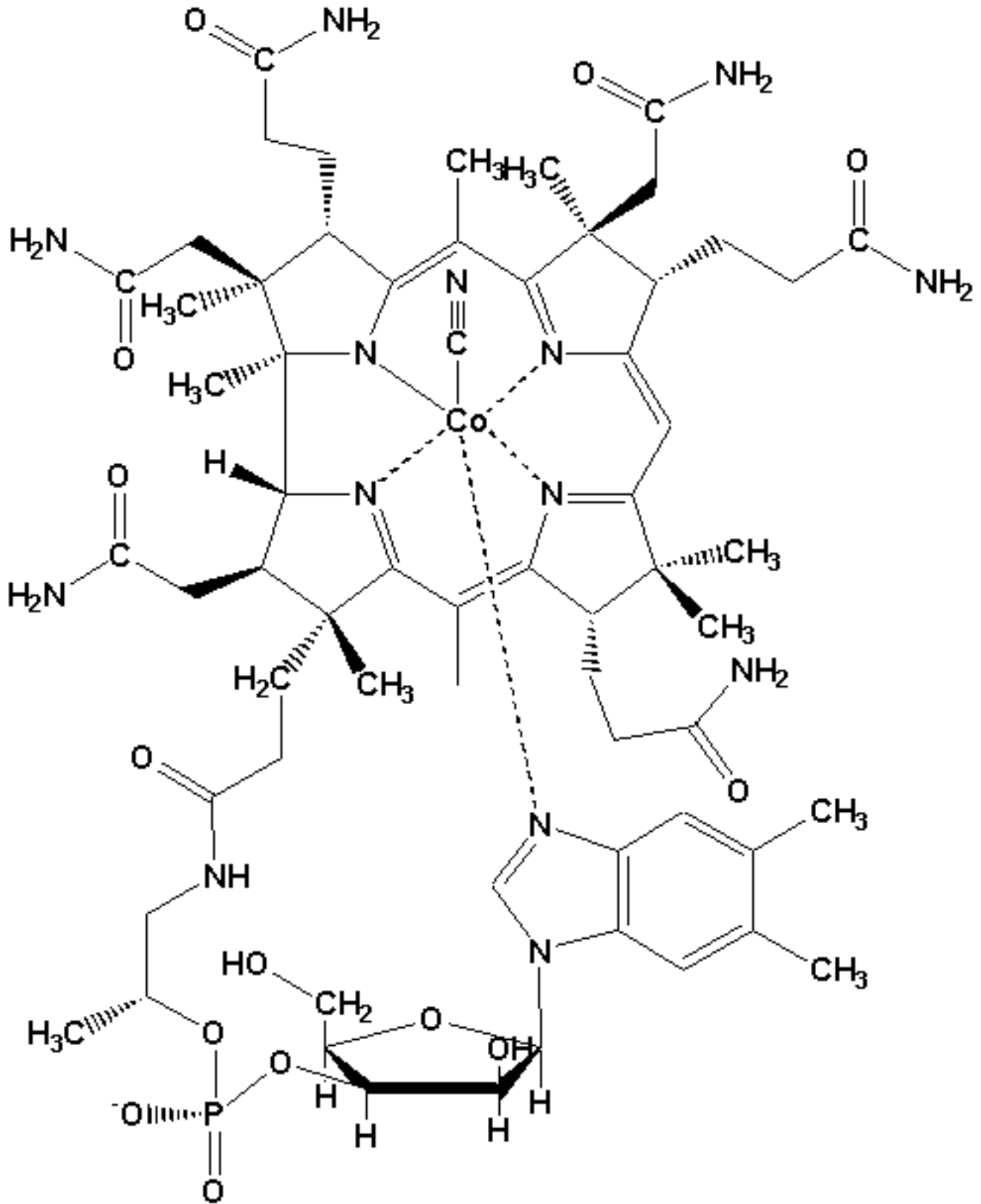

Cyanocobalamin (Vitamin B12)

species that carry out specialized fermentations. Only two reactions occur to a significant extent in mammalian metabolism: the synthesis of **methionine** from **homocysteine** (see [here](#)) and isomerization

of [D-methylmalonyl-CoA](#) to [succinyl-CoA](#) (see [Figure 20.20](#) and [here](#)).

With one exception, the known **B12**-requiring reactions involve either (1) methyl group transfer or (2) adenosylcobalamin-dependent isomerizations. The isomerizations exchange a carbon-bound hydrogen with another carbon-bound functional group as shown [here](#). The one exception is an intermolecular transfer reaction catalyzed by a ribonucleotide reductase of *Lactobacillus*.

B12 coenzymes have either a methyl group or a 5'-adenosyl moiety linked to cobalt making them the first known organometallics in metabolism ([Figure 20.19](#)). Free radical intermediates and a change in the oxidation of cobalt are features of catalysis of the methylmalonyl-CoA mutase. All observations of this reaction imply that the covalent carbon-cobalt bond on the coenzyme undergoes transient homolytic cleavage during catalysis. That is, the cobalt and the carbon each acquire one electron from the pair that formed the bond, creating a free radical at the adenosine C-5'. Interaction with the substrate then creates a substrate radical, as shown for methylmalonyl-CoA mutase in [Figure 20.20](#).

Pernicious anemia arises from a B12 deficiency. Gastric tissue secretes a glycoprotein called intrinsic factor, which complexes with ingested **B12** in the digestive tract and promotes its absorption through the small intestine into the blood stream. Pernicious anemia results from insufficient secretion of intrinsic factor. [Figure 20.22](#) outlines a probable explanation for why failure to absorb **B12** leads to the deficiency of red blood cells that define anemias.

1. When **B12** levels are low, flux through the methionine synthase reaction decreases but, because adequate dietary methionine is usually available, protein metabolism is not immediately disturbed.
2. Reduction of [5,10-methylenetetrahydrofolate](#) to [5-methyltetrahydrofolate](#) continues because this reaction is virtually irreversible.
3. Because methionine synthase is the only mammalian enzyme known to act on 5-methyltetrahydrofolate, the decreased intracellular activity of this enzyme causes 5-methyltetrahydrofolate to accumulate, at the expense of depleted pools of the other tetrahydrofolate coenzymes. Thus, even though total folate levels may seem ample, there is a functional folate deficiency, with insufficient levels of the formyl and methylene derivatives needed for synthesis of nucleic acid precursors.

See also: [Methylmalonyl-CoA Epimerase](#), [Coenzymes in Nitrogen Metabolism](#), [S-Adenosylmethionine and Biological Methylation](#), [Porphyrin and Heme Metabolism](#)

Figure 27.5: The lac operon mRNA.

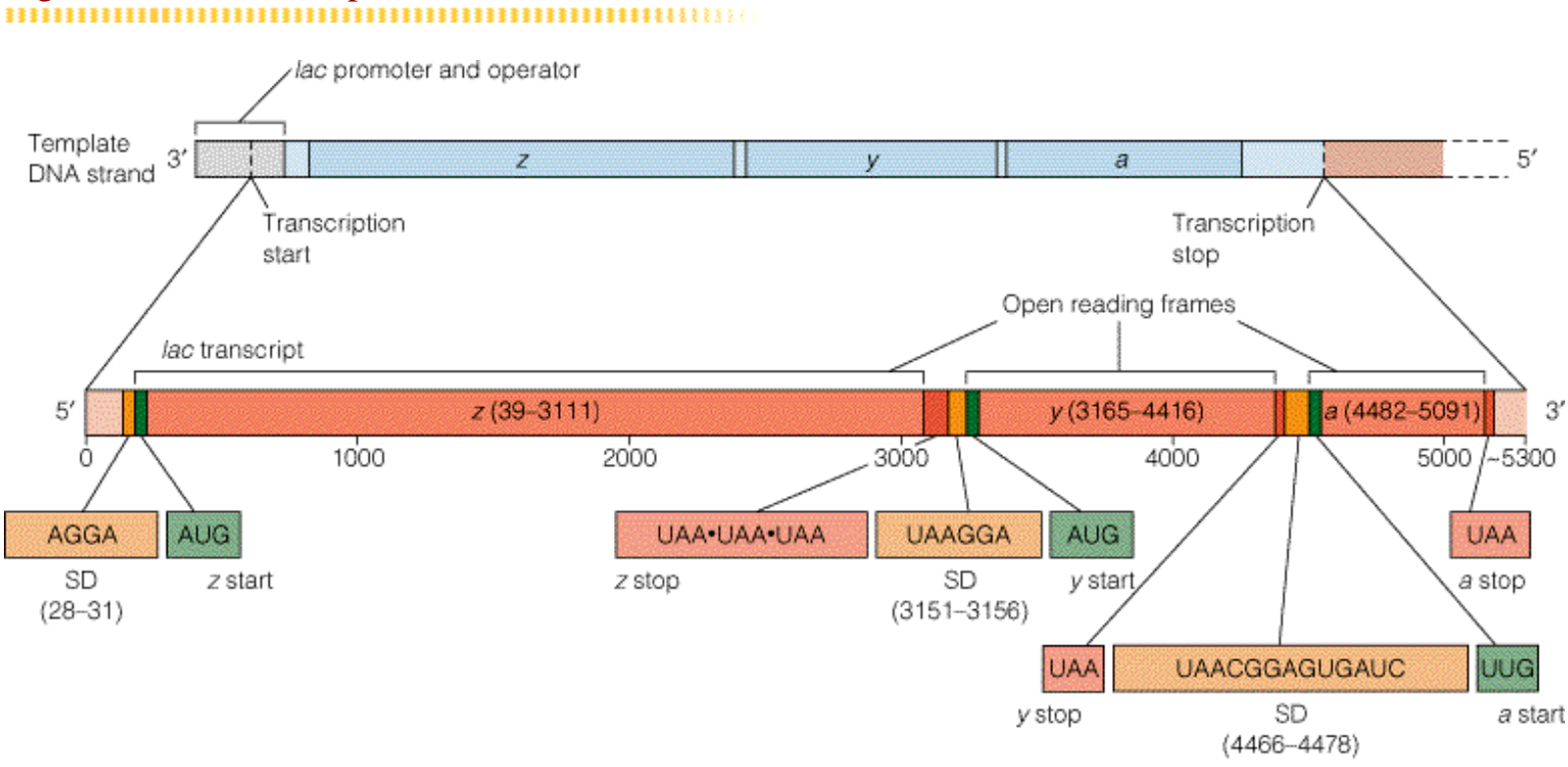

Table 27.3

Message for	Shine–Dalgarno Sequence
Ribosomal protein L10	<p style="text-align: center;">SD sequence Start</p> <p>5' [] AGGAGCAAAGCUAUG [] 3' mRNA</p> <p style="text-align: center;"> </p> <p>3' AUUCCUCCA 5' Complementary 3' end of 16S ribosomal RNA</p>
<i>E. coli lac z</i>	<p>5' [] AGGAAACAGCU AUG [] 3'</p> <p style="text-align: center;"> </p> <p>3' AUUCCUCCA 5'</p>
λ phage Cro	<p>5' [] UAAGGAGGUUGU AUG [] 3'</p> <p style="text-align: center;"> </p> <p>3' AUUCCUCCA 5'</p>

Structure of tRNAs

In the universal genetic code, 61 codons specify 20 amino acids. There are not 61 different **tRNAs** molecules, however, because some **tRNAs** can recognize more than one codon (especially when the difference is in the wobble position).

The generalized cloverleaf-like structure of a **tRNA** molecule (without its corresponding **amino acid**) is shown in **Figure 27.6a**. Variations on the theme are shown in **Figures 27.6b**, and **27.6c**.

tRNAs are unique among RNA molecules in their high content of unusual and modified bases (**Figure 27.7**). The anticodon loop contains the three base sequence complementary to the mRNA codon that base pairs with it during translation. **tRNA** molecules have a 3' end that hangs over the 5' end. This region, called the acceptor stem, is where the amino acid is covalently attached. It always ends in the sequence 5'-CCA-3'. When the amino acid is attached, the amino acid is referred to as "charged." Other features of **tRNAs** include the D loop, the T^ΨC loop, and the variable loop. The three-dimensional structure of **tRNAs** is held together by the **hydrogen bonds** that result from intramolecular base pairing. In some cases, the base pairings are unusual (**Figure 27.9**).

See also: **The Genetic Code**, **Posttranscriptional Processing of rRNA and tRNA** (from Chapter 26), **Formation of Aminoacylated tRNAs**

INTERNET LINKS:

1. **Small RNA Database**
 2. **The RNA World**
 3. **RNA Modification Database**
 4. **tRNA Sequence Database**
-

Figure 27.6: Structure of tRNAs.

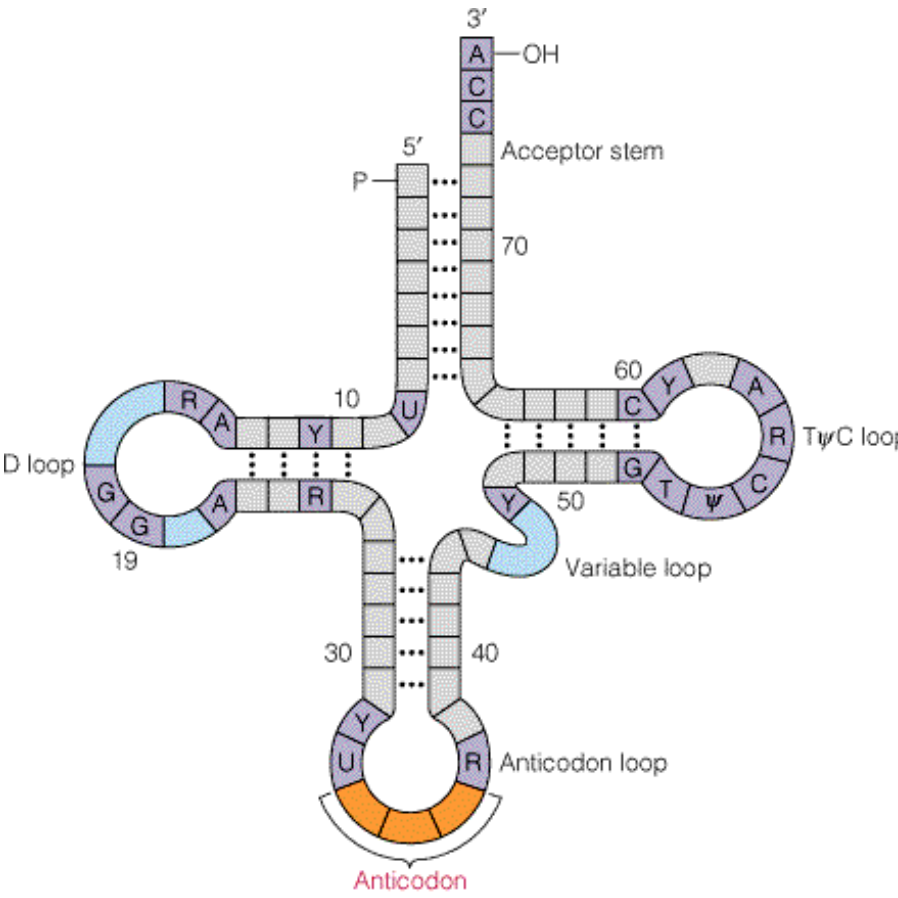

(a)

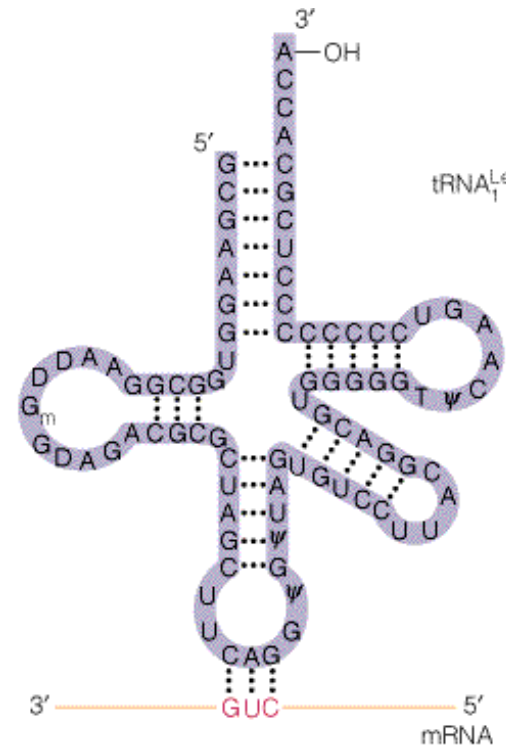

(b)

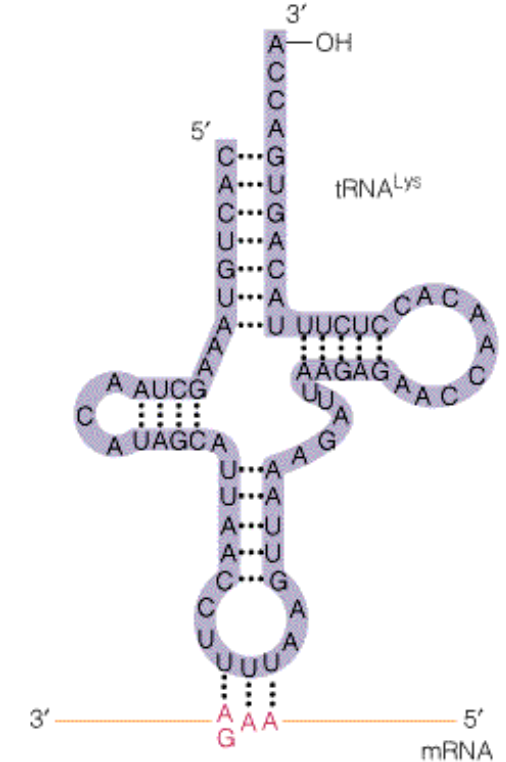

(c)

Figure 27.7: A sampling of the modified and unusual bases found in tRNAs.

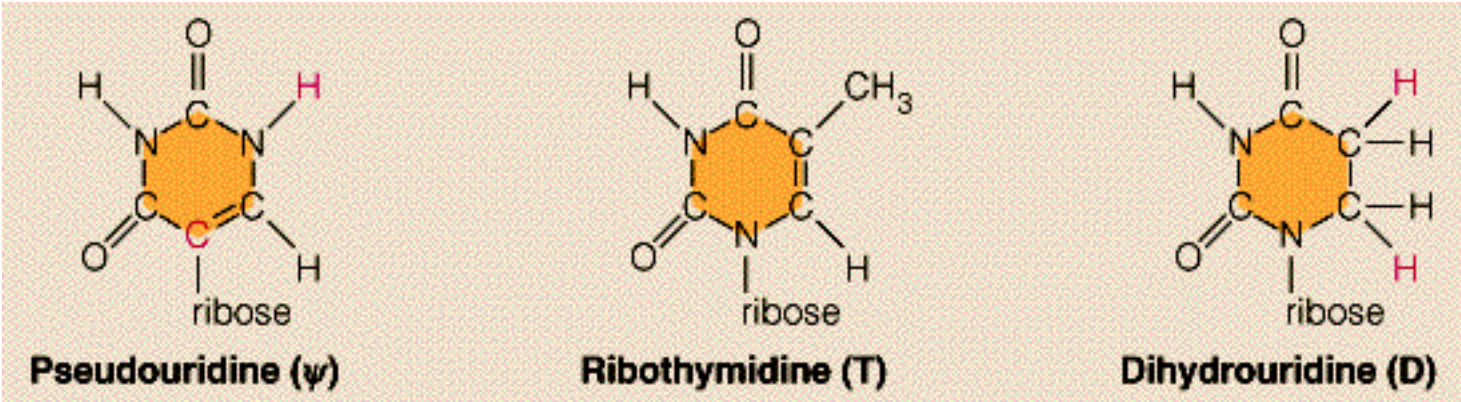

Hydrogen Bonds

The **hydrogen bond** is an interaction between a covalently bonded hydrogen atom on a donor group (i.e., -OH or $\text{-}\overset{|}{\text{N}}\text{H}$) and a pair of nonbonded electrons on an acceptor group (i.e., $\overset{\cdot\cdot}{\text{O}}=\text{C}^-$ or $:\text{N}\equiv$) as shown in [Figure 2.7](#). The atom to which hydrogen is covalently bonded is called the **hydrogen bond donor** and the atom with the nonbonded electron pair is called the **hydrogen bond acceptor**. **Hydrogen bond donors** tend to be highly electronegative atoms, such as N and O, because they can withdraw negative charge from the hydrogen atom, thus making it partially positive and, thus, more strongly attracted to the electron pair of the **hydrogen bond acceptor**.

Hydrogen bonds have characteristics of covalent and noncovalent bonds. For example, the attraction between the partially positive hydrogen and the negative charge of the electron pair is like a charge-charge interaction ([Figure 2.2a](#)). At the same time, there is electron sharing (as in a covalent bond) between the hydrogen atom and the **hydrogen bond acceptor**.

Other features that suggest **hydrogen bonds** are partially covalent in character include the following:

- **Hydrogen bond** lengths are fixed at about 0.33 nm (See [Table 2.3](#))
- **Hydrogen bonds** are highly directional - the donor **H bond** tends to point directly at the acceptor electron pair.
- The energy of **hydrogen bonds** is greater than most other noncovalent interactions.

Hydrogen bonds provide forces that help stabilize the structures of macromolecules, such as DNA and proteins, give a molecule like water its unusual chemical characteristics for its size (see [Table 2.4](#), [Table 2.5](#)), and the **hydrogen bonds** of water also assist in solubilizing polar compounds.

See also: [Covalent Bonds vs Non-Covalent Forces](#), DNA, [Secondary Structure](#) (from Chapter 2), [Dynamics of Protein Folding](#)

Figure 2.7: The hydrogen bond.

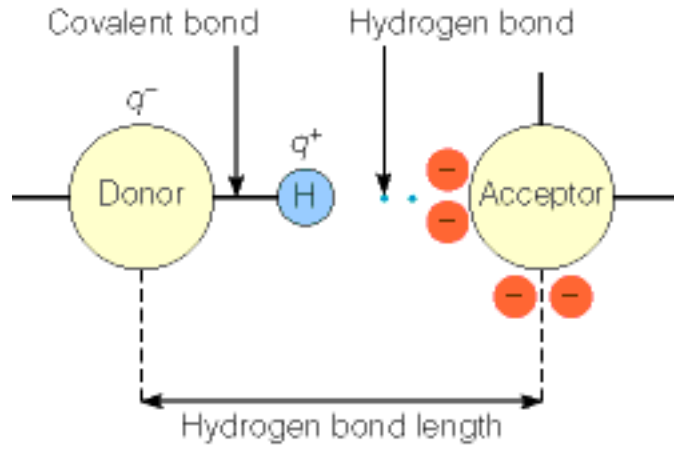

Figure 2.2: Types of noncovalent interactions.

Type of Interaction	Model	Example	Dependence of Energy on Distance
(a) Charge–charge Longest-range force; nondirectional		$-\overset{+}{\text{N}}\text{H}_3$	$1/r$
(b) Charge–dipole Depends on orientation of dipole		$-\overset{+}{\text{N}}\text{H}_3$	$1/r^2$
(c) Dipole–dipole Depends on mutual orientation of dipoles			$1/r^3$
(d) Charge–induced dipole Depends on polarizability of molecule in which dipole is induced		$-\overset{+}{\text{N}}\text{H}_3$	$1/r^4$
(e) Dipole–induced dipole Depends on polarizability of molecule in which dipole is induced			$1/r^5$
(f) Dispersion Involves mutual synchronization of fluctuating charges			$1/r^6$
(g) van der Waals repulsion Occurs when outer electron orbitals overlap			$1/r^{12}$
(h) Hydrogen bond Charge attraction + partial covalent bond			Length of bond fixed

Table 2.3

Donor...Acceptor	Bond Length ^a (nm)	Comment
	0.28 ± 0.01	H bond formed in water
	0.28 ± 0.01	} Bonding of water to other molecules often involves these
	0.29 ± 0.01	
	0.29 ± 0.01	} Very important in protein and nucleic acid structures
	0.31 ± 0.02	
	0.37	

^aDefined as distance from center of donor atom to center of acceptor atom. For example, in the $\text{N}-\text{H}\cdots\text{O}=\text{C}$ bond it is the $\text{N}-\text{O}$ distance.

Table 2.4

Compound	Molecular Weight	Melting Point (°C)	Boiling Point (°C)	Heat of Vaporization (kJ/mol)
CH ₄	16.04	-182	-164	8.16
NH ₃	17.03	-78	-33	23.26
H ₂ O	18.02	0	+100	40.71
H ₂ S	34.08	-86	-61	18.66

Table 2.5



Property	Water	<i>n</i> -Pentane
Molecular weight (g/mol)	18.02	72.15
Density (g/cm ³)	0.997	0.626
Boiling point (°C)	100	36.1
Dielectric constant	78.54	1.84
Viscosity (g/cm·s)	0.890×10^{-2}	0.228×10^{-2}
Surface tension (dyne/cm)	71.97	17

^aAll data are for 25°C.

Covalent vs Non-Covalent Bonds

Covalent bonds are the forces that hold atoms together as molecules. For example, the two O-H bonds in water molecules are **covalent bonds**. The **covalent bonds** most important in biology (C-C and C-H) have bond energies in the range of 300-400 kJ/mol.

Non-covalent interactions (also called **noncovalent forces** or **noncovalent bonds**) are weak interactions between ions, molecules, and parts of molecules. They help shape individual molecules and groups of molecules and ions, but are weak enough to be continually broken and re-formed in the dynamic molecular interplay that is life. In fact, [Figure 2.1](#) shows that biologically important **noncovalent interactions** are 10-100 times weaker than **covalent bonds**.

The different types of **noncovalent interactions** are summarized in [Figure 2.2](#). All are fundamentally electrostatic in nature; that is, all depend on the forces that electrical charges exert on one another. Note that all but hydrogen bonds decrease with distance.

For cells, both **covalent bonds** and **noncovalent interactions** are important. DNA, for example, is composed of two intertwined chains of polynucleotides. The forces that hold together the atoms of the nucleotides in each individual chain are **covalent**. The forces that hold the two chains together, however, are **noncovalent hydrogen bonds**. The weaker hydrogen bond forces are strong enough to keep the two chains together, but weak enough to enable the cell to pull the chains apart when necessary to perform DNA replication (see [here](#)) or other processes that require the chains to be separated.

See also: [Coulomb's Law](#), [Dielectric Constant](#), [Hydrogen Bonds](#), [DNA](#)

Figure 2.1: Covalent and noncovalent bond energies.

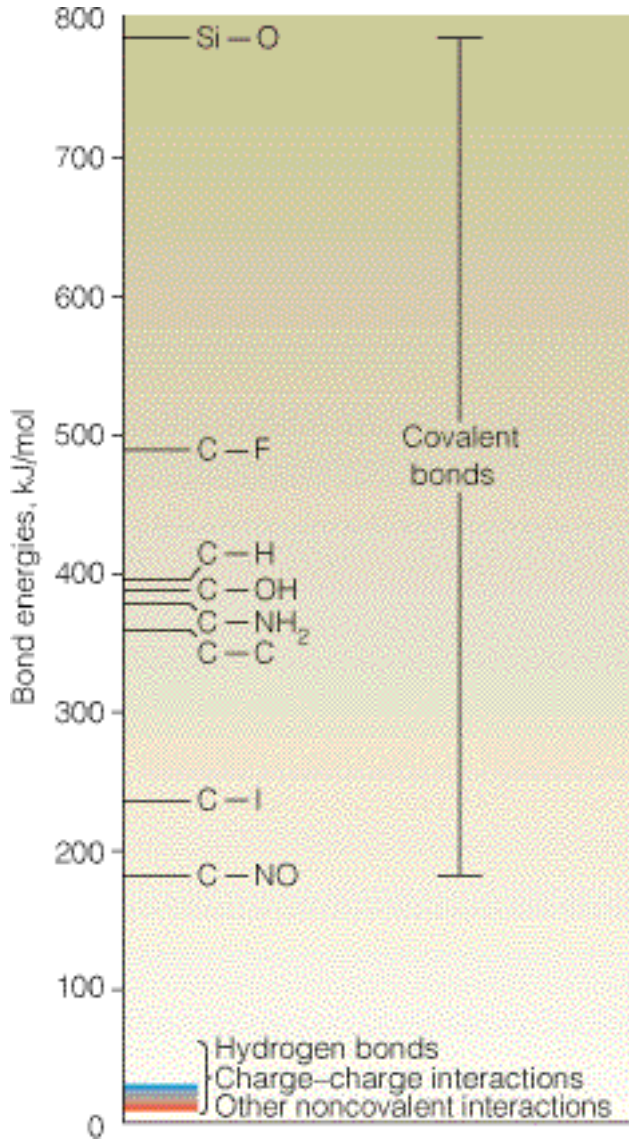

DNA Replication Overview



DNA replication is an essential aspect of cellular and viral reproduction. **Replication** of a double-stranded DNA results in two double-stranded DNAs as products. Some important general points about **DNA replication** are as follows:

The mechanism of **replication** is semi-conservative--each newly made strand is copied from one of the parental strands and the products of replication are two molecules, each containing one parental strand and one newly synthesized strand (see [here](#)).

DNA replication intermediates contain "forked" structures at the site of replication ([Figure 24.1](#)).

Replication is orderly and sequential--it begins at a fixed point (called an origin) and closely follows parental duplex unwinding.

DNA replication uses deoxyribonucleoside-5'-triphosphates (dNTPs) to build the DNA chains.

DNA replication is discontinuous--synthesis of one strand (called the lagging strand) lags behind the other (called the leading strand) and occurs in pieces called Okazaki fragments ([Figure 24.4](#)). Replication of the leading strand is continuous ([Figure 24.3](#)).

Replication is exceedingly accurate--far more accurate than any other enzyme-catalyzed process.

Replication can be broken down into three processes--initiation, elongation, and termination.

Multiple proteins are required for **DNA replication** at a replication fork. These include DNA polymerases, single-strand DNA binding proteins, helicases, primase, topoisomerases, and DNA ligase. Some of these are multisubunit protein complexes.

DNA polymerase catalyzes the chemical reaction of DNA synthesis ([Figure 24.2](#)).

DNA chain growth (**replication**) proceeds only in the 5' to 3' direction.

See also: [Replication Fork](#), [Replication Complexes](#), [Fidelity of DNA Replication](#), [Semiconservative](#)

DNA Replication (from Chapter 4), ***E. coli* DNA Polymerases**, **Eukaryotic DNA Polymerases**, **Other Replication Proteins**, **Topoisomerases**

INTERNET LINKS:

1. DNA Replication

Unnumbered Item

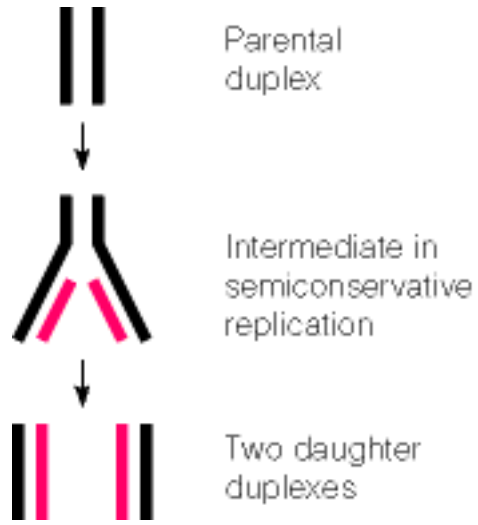

Figure 24.1: Simplified view of a replication fork.

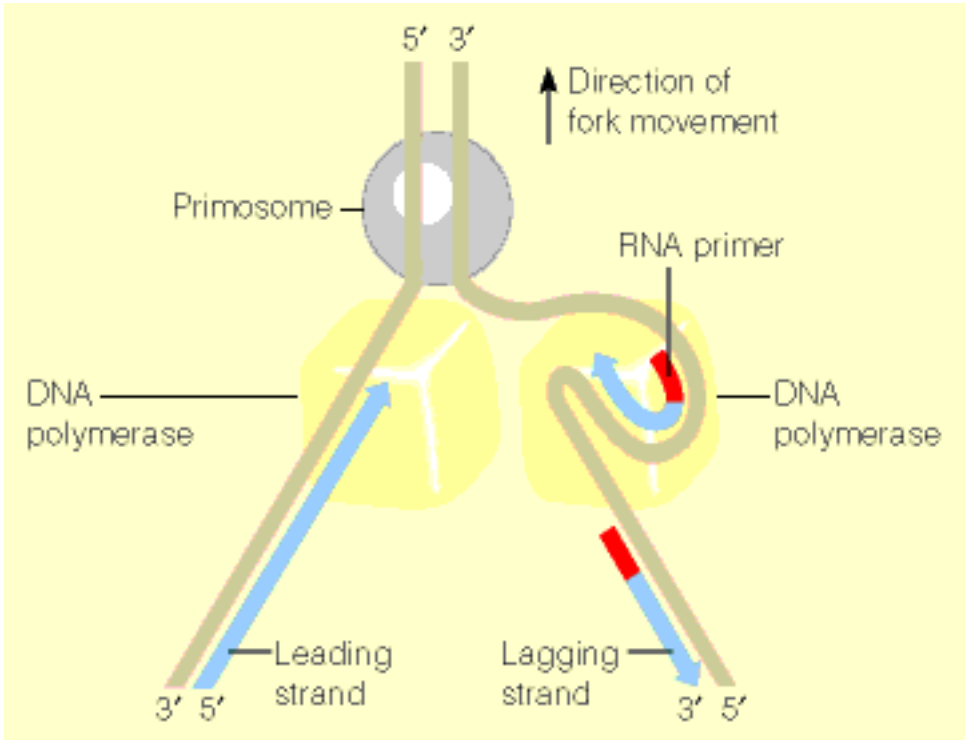
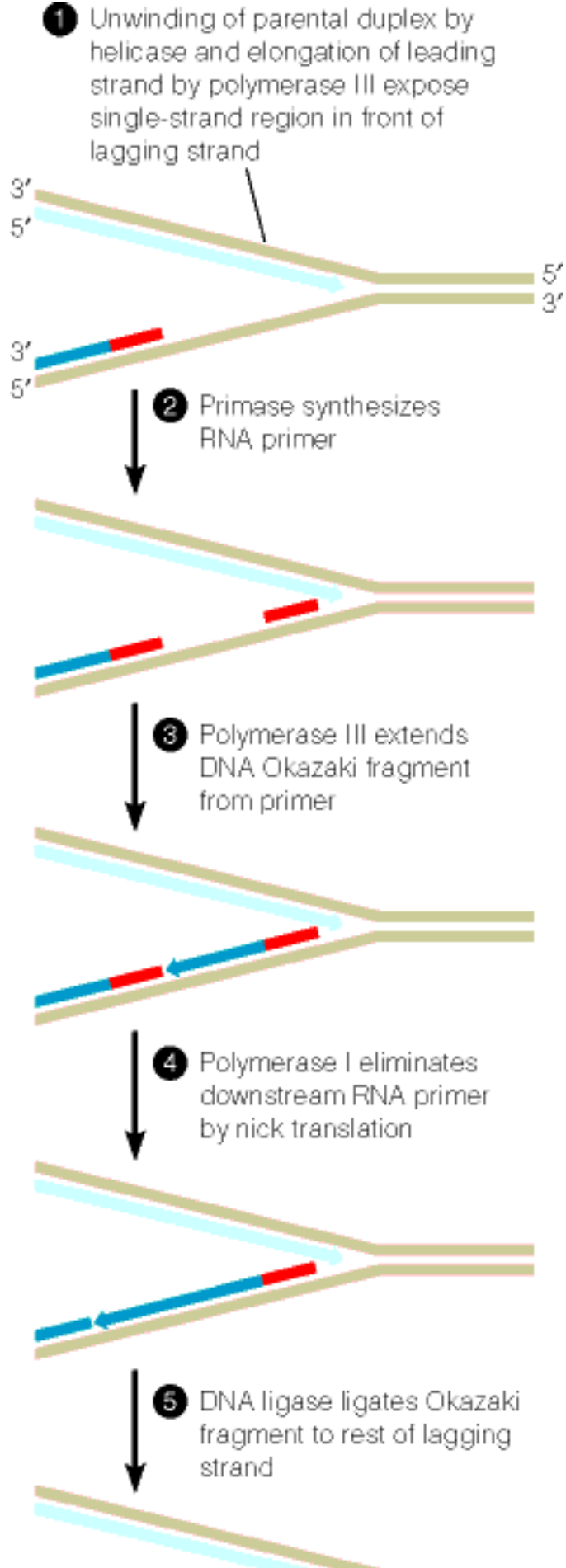

Figure 24.4: Details of lagging strand synthesis.



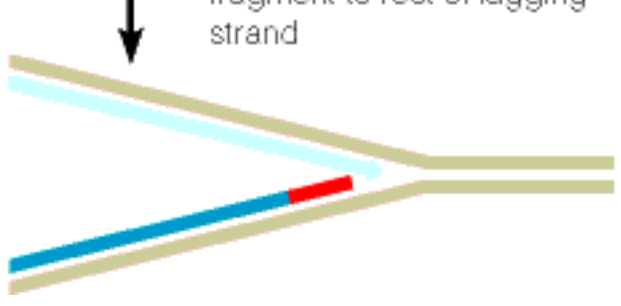

Figure 24.3: The Okazaki model.

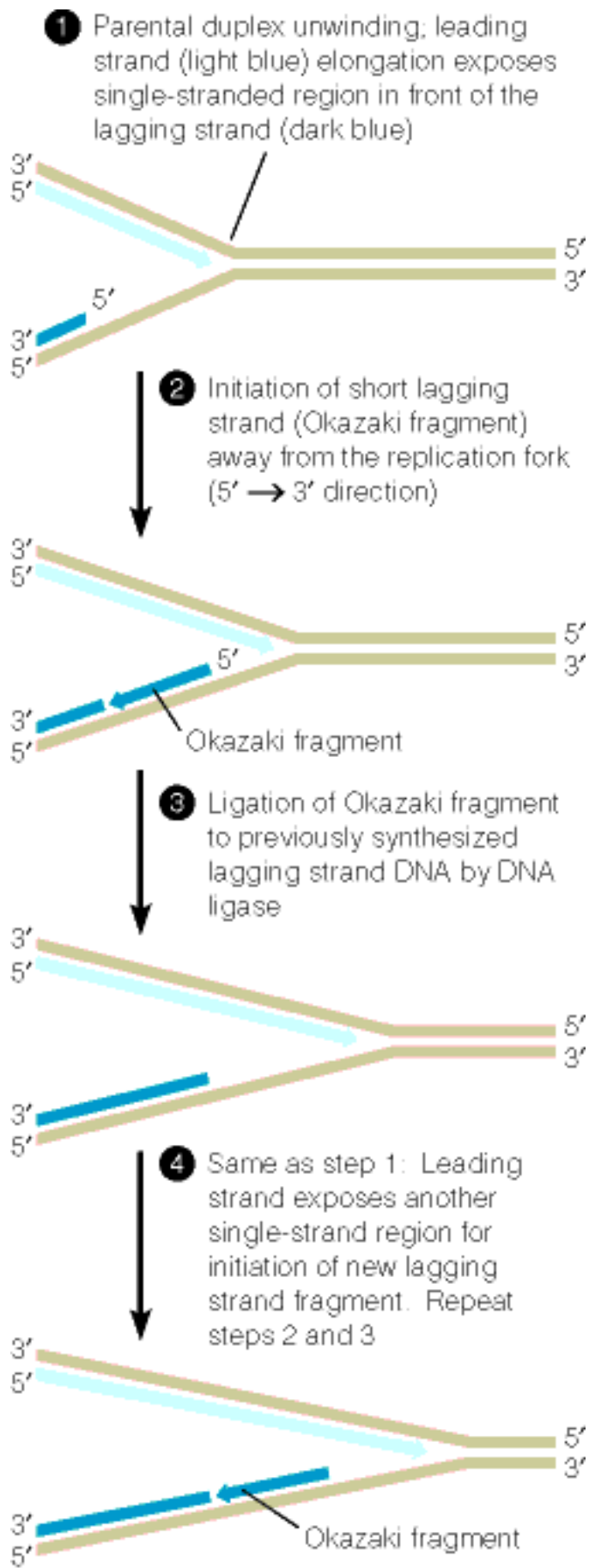
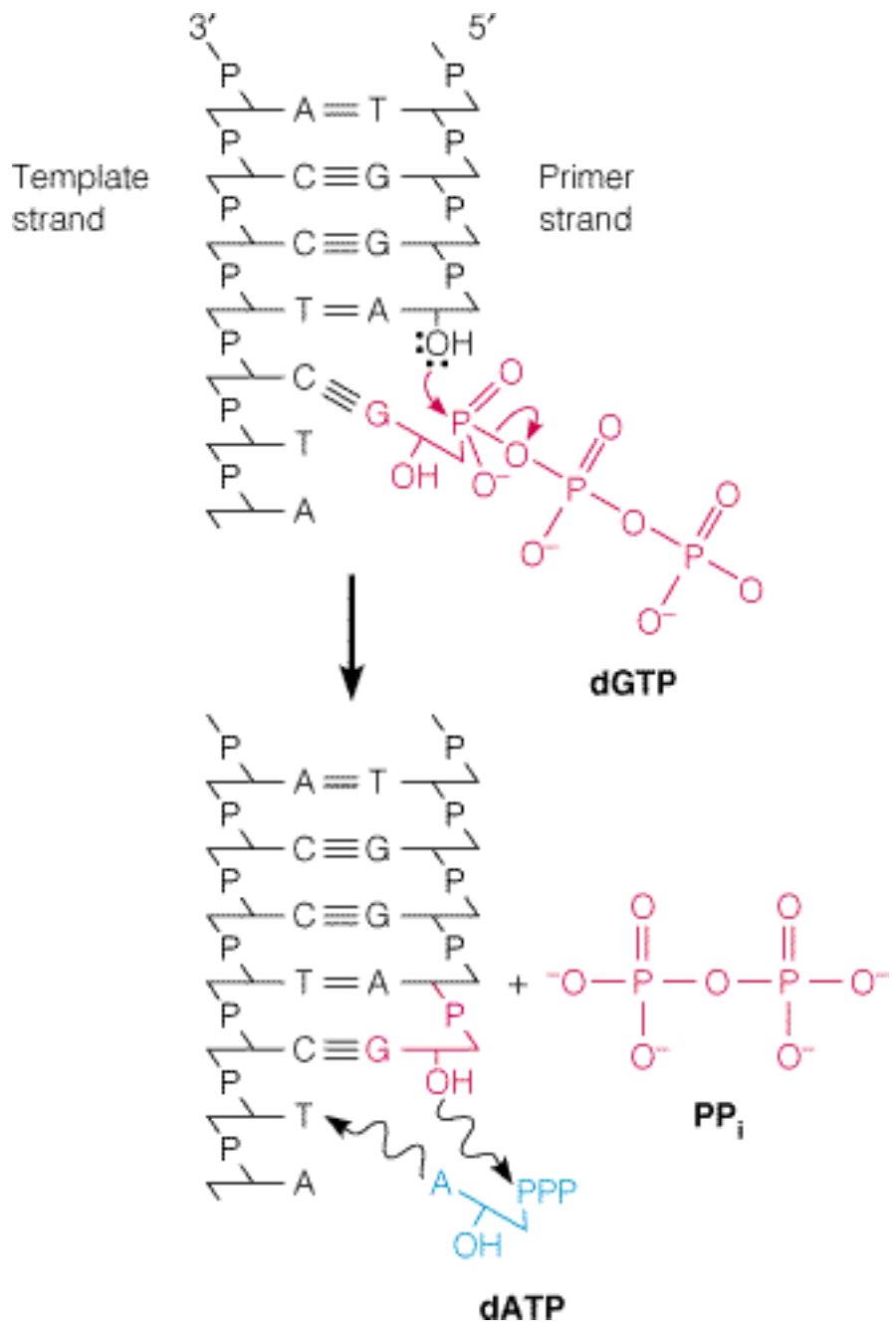



Figure 24.2: The DNA polymerase reaction.



Replication Fork



Replication of DNA occurs at a molecular junction that is usually drawn schematically as a fork and is hence called a **replication fork**. [Figure 24.6](#) depicts a **replication fork** in *E. coli* along with many of the proteins that participate in DNA replication. The figure shows that leading strand and lagging strand replication occur on opposite strands at the same **replication fork** and that replication proceeds for both strands in the 5' to 3' direction. The terms in [Figure 24.6](#) are described below:

Topoisomerase - an enzyme that relieves the torsional stress that arises ahead of the replication fork when the helicase enzyme unwinds the DNA strands ([Figure 24.30](#), [Figure 24.31](#)).

DNA polymerase - catalyzes the chemical reactions for polymerization of nucleotides.

Helicase - ([Figure 24.27](#)) an enzyme that unwinds DNA strands ahead of the DNA polymerase. Each strand of parental DNA has its own helicase. The one associated with the lagging strand is complexed with primase as part of a unit called the primosome.

Primase - an enzyme that copies a DNA template strand by making an RNA strand complementary to it. The RNA serves as a priming site where DNA polymerase can begin to synthesize a DNA strand.

Primosome - a complex containing a primase and helicase. It helps to initiate DNA replication by synthesizing an RNA primer and to elongate it by unwinding the strands in advance of the replication complex.

Single-strand DNA-binding protein (SSB) - binds single-stranded DNA to stabilize it so that the hydrogen-bonding surfaces of the DNA bases are spatially oriented toward the incoming nucleotides ([Figure 24.26](#)).

Sliding clamp - a protein dimer that encircles the DNA strand and helps hold the DNA polymerase to the DNA strand.

RNA primer - a preexisting nucleic acid strand of RNA on which DNA replication is continued. The initiation of DNA synthesis requires a preexisting nucleic acid strand, so RNA primers are frequently used for this purpose. RNA primers are made by the primase enzyme.

Okazaki fragment - short discontinuous stretches of DNA arising from replication on the lagging strand. Okazaki fragments are named for the biochemists who discovered them.

DNA polymerase I and DNA ligase - the two enzymes that assemble short Okazaki fragments into a single continuous strand. DNA polymerase I has a catalytic activity that can remove RNA primers then replace them with DNA. DNA ligase catalyzes the covalent joining of the individual pieces of the lagging strand.

Leading strand - the strand of DNA at a replication fork that replicates continuously.

Lagging Strand - the strand of DNA at a replication fork that replicates in pieces (Okazaki fragments).

See also: [Replication Complexes](#), [*E. coli* DNA Polymerases](#), [Eukaryotic DNA Polymerases](#), [Other Replication Proteins](#), [Topoisomerases](#)

INTERNET LINKS:

1. [Replication Fork Page](#)
 2. [Primase](#)
 3. [Helicase](#)
 4. [Rotating SSB](#)
 5. [Replication Fork Movie](#)
 6. [Bacteriophage T4 Replication Fork](#)
 7. [The Collaboration of Proteins During Replication](#)
-

Figure 24.6: Schematic view of a replication fork.

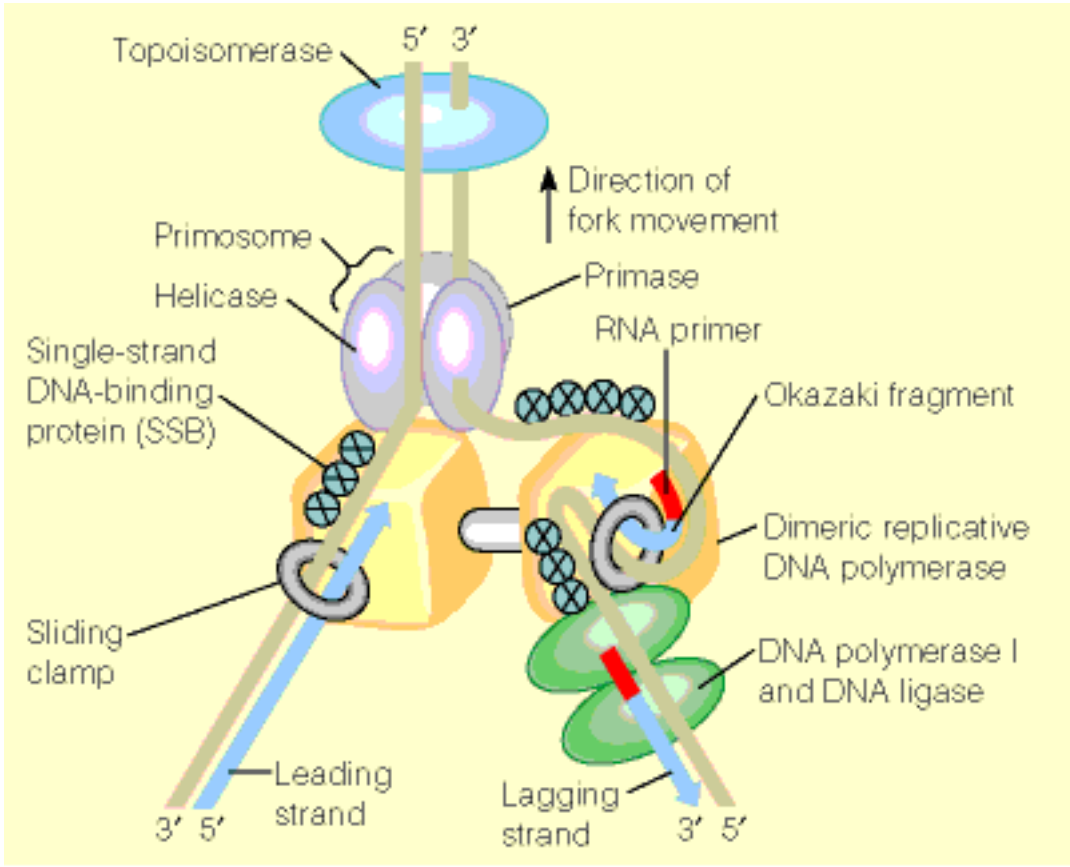

Figure 24.30: Action of a type I topoisomerase.

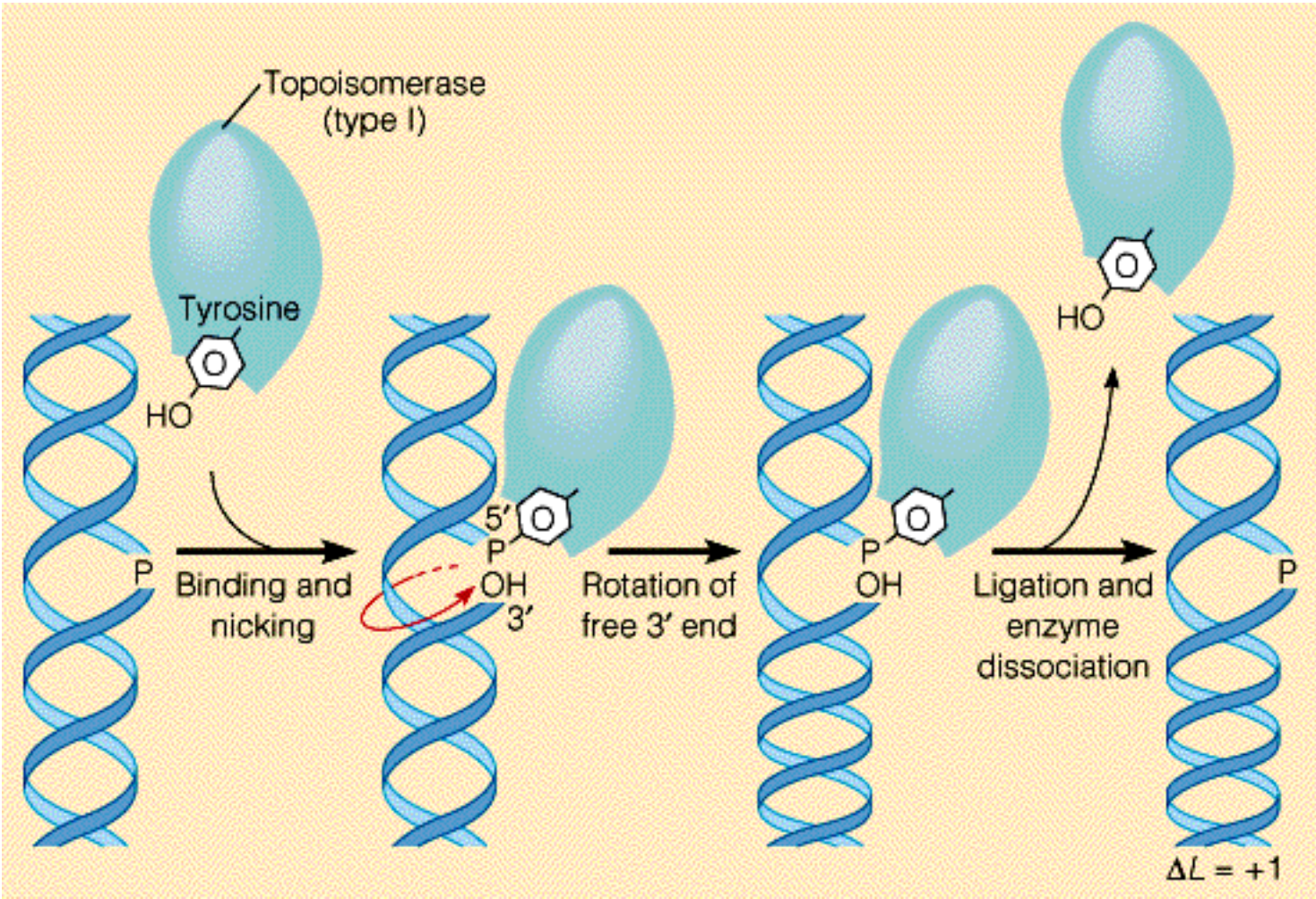
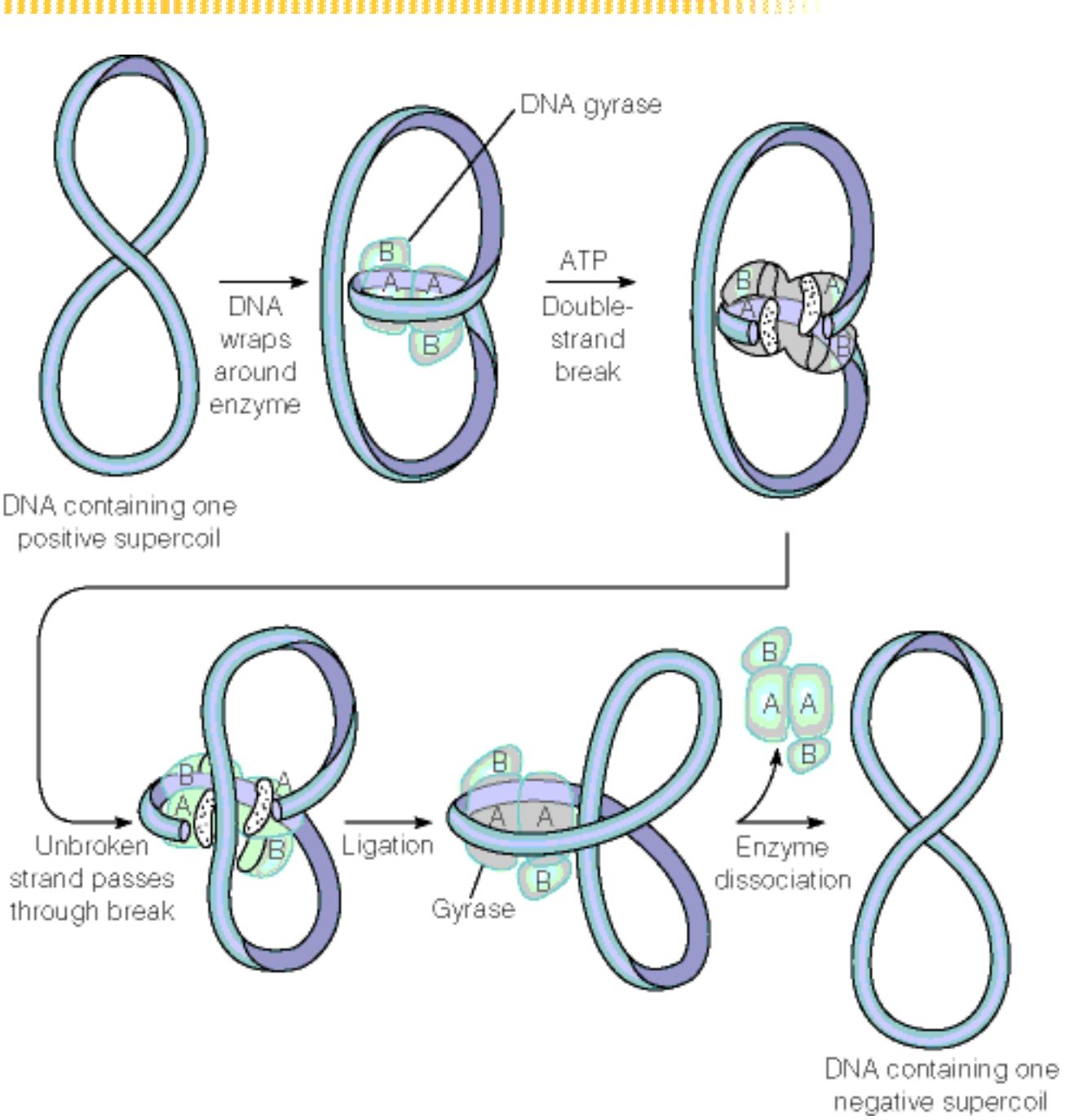
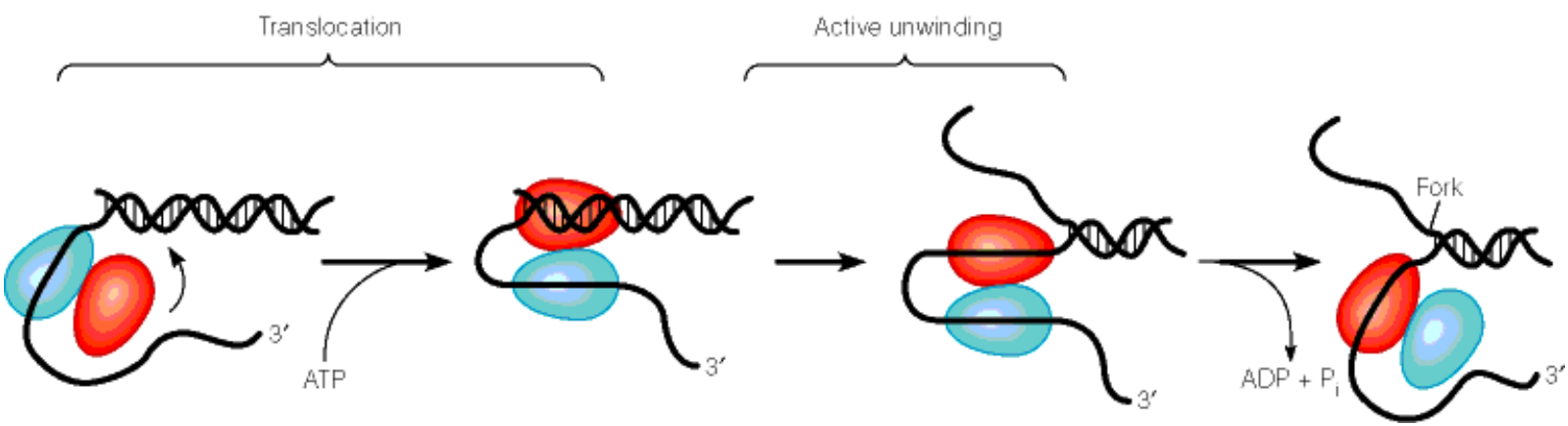

Figure 24.31: Action of a type II topoisomerase.



Adapted from A. Kornberg and T. A. Baker, DNA Replication, 2nd ed. (New York: W. H. Freeman and Co., 1992), p. 390. © 1992 W. H. Freeman and Co. Used with permission.

Figure 24.27: A model for helicase action.



Courtesy of G. Waksman from S. Korolev et al., Cell (1997) 90:635-647. © Cell Press.

Figure 24.26: gp32 facilitation of both denaturation and renaturation of DNA.

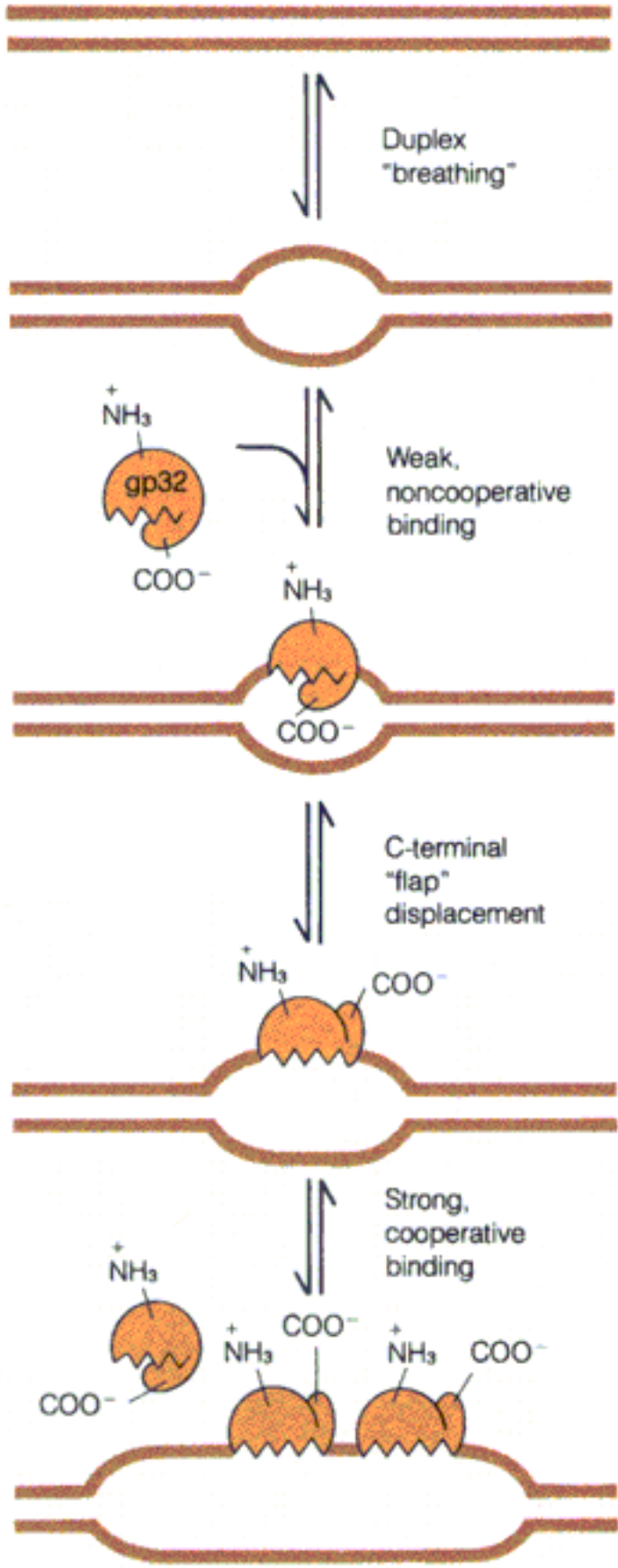



Replication Complexes

The term replisome is used to refer to the multiprotein **replication complex**. Numerous replication systems from *E.coli*, bacteriophage, and viral systems have been described. The first eukaryotic replication system to be purified was for the small circular DNA genome of the virus SV40. [Table 24.4](#) lists the functions of the proteins in three reconstituted DNA replication systems.

[Figure 24.36](#) shows a generalized replication scheme for single strand phage DNA. The main points are as follows:

1. The single plus (+) strand genome enters cells. It serves as the template for the synthesis of the complementary minus (-) strand.
2. The duplex, called RFI, has superhelical turns introduced into it.
3. A site-specific initiation protein nicks the DNA at a specific sequence in the (+) strand and attaches to its 5' end.
4. Replication proceeds via extension of the 3' end. The 5' end is displaced in a rolling circle mechanism and single strand DNA binding proteins attach to the displaced strand.
5. 5' to 3 extension continues.
6. Completion of one full circle of replication causes a protein to nick and release the original plus strand and generate a new duplex (called RFII) containing the original minus strand.

See also: [Other replication proteins](#)

Table 24.4



Function	<i>E. coli</i>	Phage T4	SV40/human
Polymerase	α subunit of pol III holoenzyme	gp43	pol δ , α subunit of pol α -primase
Primase	DnaG	gp61	Primase subunit of pol α -primase
Proofreading exonuclease	ϵ subunit of pol III holoenzyme	3'-exo domain of gp43	3'-exo domain of pol δ
Sliding clamp	β subunit of pol III holoenzyme	gp45	PCNA
Clamp loader	γ complex	gp44/62	RF-C
Helicase	DnaB	gp41	SV40 T antigen
Single-strand DNA-binding protein	SSB	gp32	RP-A
RNA primer removal	RNase H, pol I	T4 RNase H, <i>E. coli</i> pol I	RNase H1, FEN1/RTH1
Lagging strand transfer from primase to polymerase	χ subunit of pol III holoenzyme	Unknown	Unknown

Figure 24.36: Replication scheme for single-strand phage DNAs.

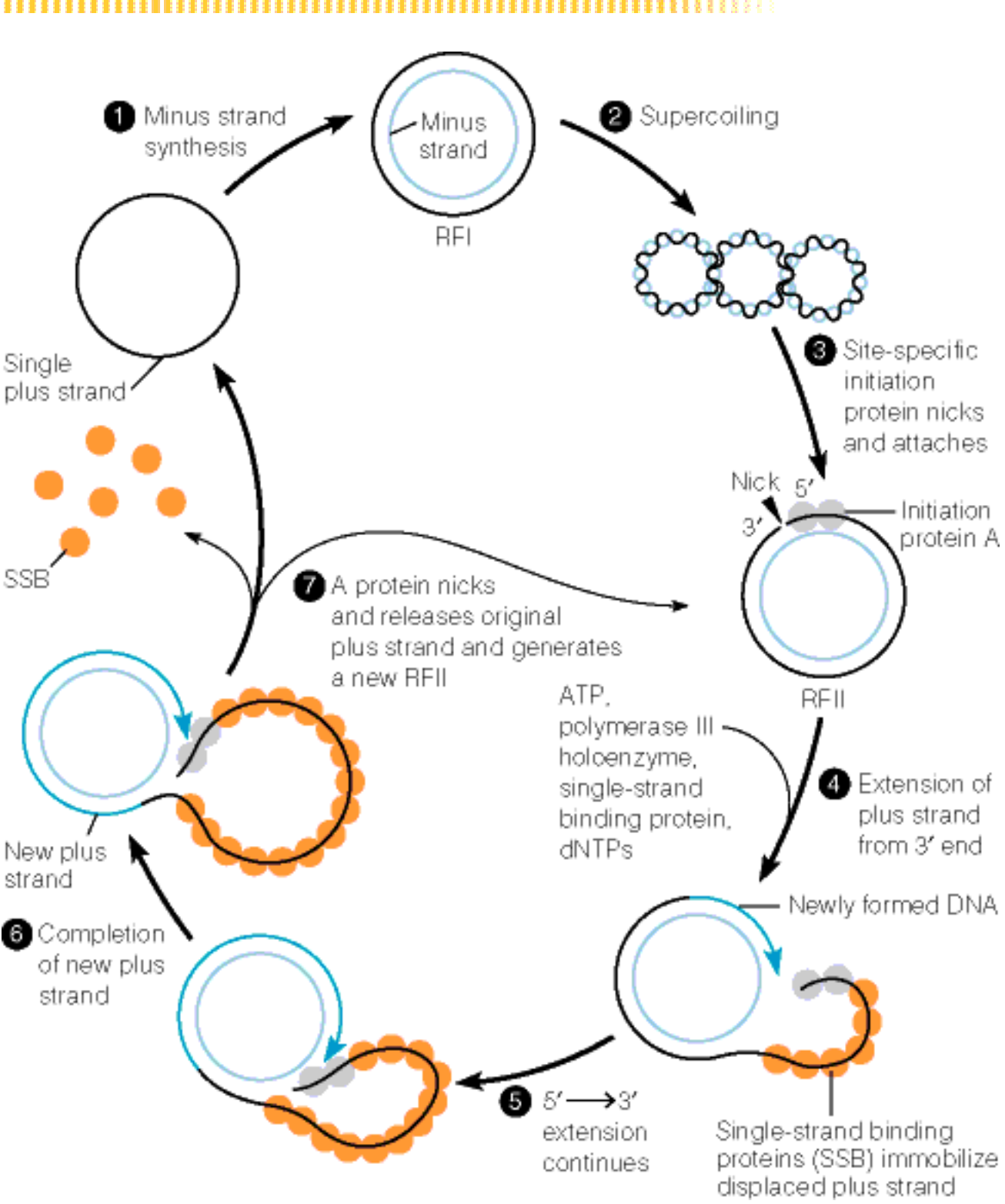

Other Replication Proteins



Research on bacteriophages has been very useful in identifying replication proteins in *E. coli*. Some of these proteins are described below:

DNA ligase ([Figure 24.24](#)) - Covalently closes nicks in double-stranded DNA. The nick must contain 3' hydroxyl and 5' phosphoryl termini and the nucleotides being linked must be adjacent in a duplex structure and properly base-paired. **DNA ligase** functions to seal Okazaki fragments in the lagging strand of DNA replication.

Primase - DNA polymerases cannot initiate the synthesis of new DNA chains, but can only extend chains from preexisting 3' hydroxyl termini. Initiation of new DNA strands in *E. coli* begins with RNA fragments. **Primase** is the enzyme responsible for catalyzing synthesis of these primers. The enzyme is active only in the presence of other proteins (including a helicase), which create a complex called the primosome. **DNA polymerase I** and RNase H are involved in removing RNA primers in the processing of DNA after replication. In eukaryotic cells, **primase** is tightly associated with DNA polymerase α (see [here](#)).

Clamps and clamp loaders - Protein β from the **DNA polymerase III holoenzyme** complex holds the polymerase to the DNA. This helps the DNA polymerase complex to stay on the DNA through an entire cycle of replication. A multisubunit entity called the γ complex functions as the "clamp loader". That is, it loads the clamp onto the DNA. In eukaryotic cells, a multi-subunit protein called replication factor C (RF-C) is the clamp loader, and proliferating cell nuclear antigen (PCNA) is the sliding clamp.

Single-strand DNA-binding (SSB) proteins - gp32 ([Figure 24.26](#)), the most studied SSB protein, binds in a strongly cooperative fashion to single-strand DNA. That is, binding adjacent to another gp32 is much more likely than the binding of a single gp32 in isolation. This property helps promote the denaturation of duplex DNA and helps keep the DNA template in an extended, single-strand conformation, with the purine and pyrimidine bases exposed so that they can base-pair readily with incoming nucleotides. Interestingly, gp32 also promotes renaturation of single-stranded DNA. SSB proteins have been found in many organisms. In *E. coli*, the protein is called *ssb*. In eukaryotic cells, a heterotrimeric protein called replication factor A serves the role of SSB in DNA replication.

Helicases ([Figure 24.28](#))- SSB proteins do not actively denature DNA and cannot actively unwind duplex DNA strands. Nevertheless, unwinding of this kind is essential if single-strand templates are to be exposed for polymerase action. The **helicase** proteins

provide this function by catalyzing the ATP-dependent unwinding of double-strand DNA. *E. coli* contains at least 6 different **helicases**--some involved in DNA repair and others in conjugation. The principal **helicase** in DNA replication is DnaB, which interacts with DnaG and other proteins to form the primosome. All known **helicases** have multiple subunits. Most are homodimers, but a few are homohexamers. [Figure 24.27](#) depicts a proposed mechanism of **helicase** action. In humans, two inherited diseases, Werner's syndrome and Bloom's syndrome, result from helicase defects.

Topoisomerases - Bidirectional replication of the circular *E. coli* chromosome unwinds about 100,000 base pairs per minute. Relief of this torsional stress is essential for DNA replication to occur. Topoisomerases are enzymes with a "swivel" mechanism that can relieve this stress. There are two general classes of **topoisomerases**, type I ([Figure 24.30](#)) and type II ([Figure 24.31](#)). Type I enzymes change the DNA linking number (see [here](#) for reference) in units of 1, whereas type II enzymes change the linking number in units of 2.

See also: [Topoisomerases](#), [Replication Fork](#), [Replication Complexes](#), [E. coli DNA Polymerases](#)

INTERNET LINKS:

1. [Helicase Page](#)
 2. [Primase Page](#)
 3. [Werner's Syndrome](#)
 4. [Werner's Syndrome](#)
 5. [Bloom's Syndrome](#)
-

Figure 24.24: The reaction catalyzed by DNA ligase.

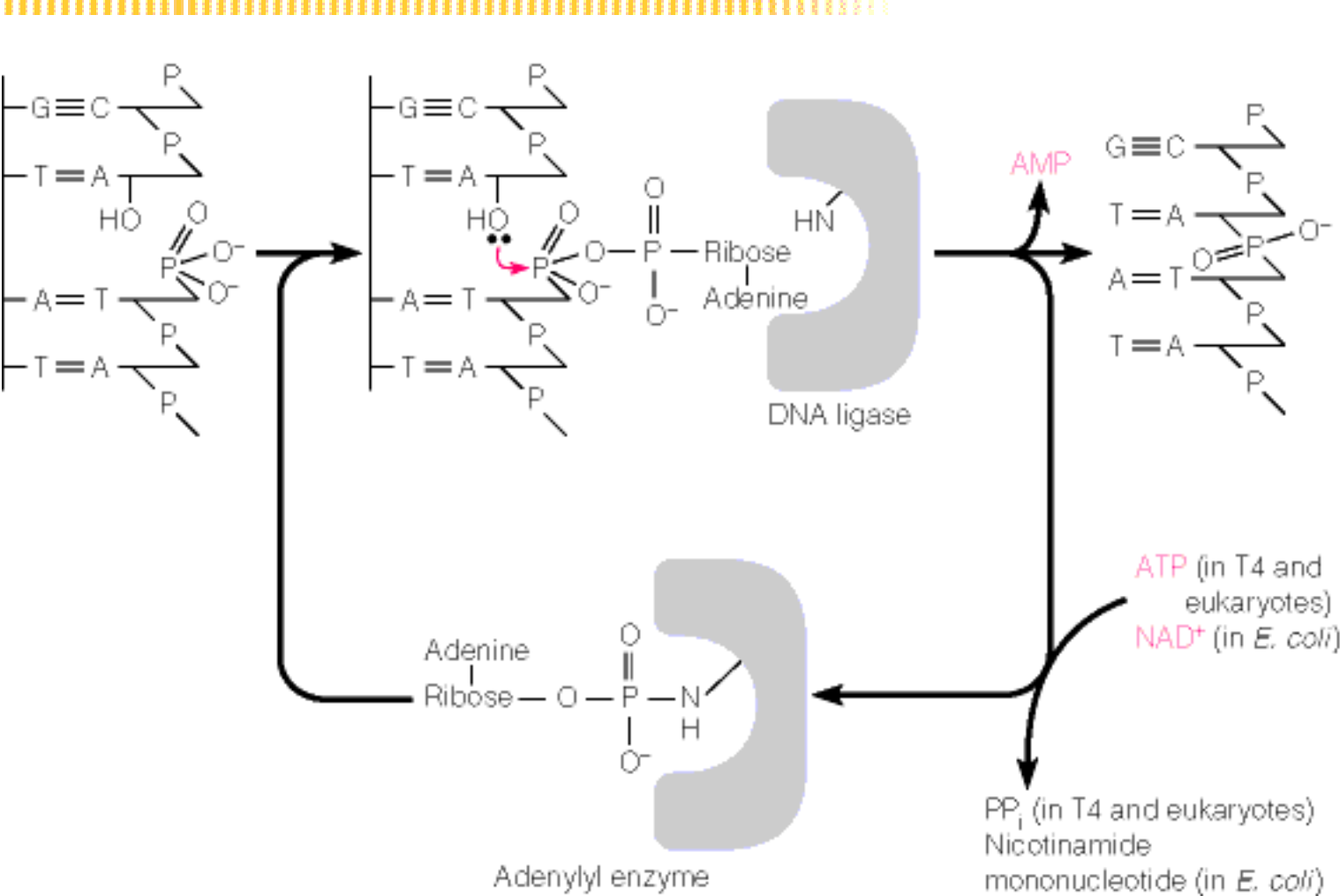

E. coli DNA Polymerase I

DNA Polymerase I is a single polypeptide chain of Mr 103,000. In addition to its polymerase activity, the purified enzyme has two nuclease activities. The first is a 3' to 5' exonuclease that degrades single-strand DNA from the 3' end and the second is a 5' to 3' exonuclease that degrades base-paired DNA from the 5' terminus. **DNA polymerase I** can also cleave RNA from a duplex containing one strand each of RNA and DNA. The 3'-5' exonuclease activity serves a "proofreading" function to improve the accuracy with which a DNA template is copied. This activity removes an improperly base-paired nucleotide from the growing 3' end of a polydeoxynucleotide chain, giving the polymerase activity a second chance to insert the correct nucleotide specified by the template.

The 5'-3' exonuclease activity plays two known roles. The first of these is the excision of RNA primers in lagging strand replication (Figures [24.4](#) and [24.5](#)) via a nick translation mechanism in which the 5'-3' exonuclease excises ribonucleotides just as the polymerase is replacing them with deoxyribonucleotides. The second known function of the 5'-3' exonuclease is to cleave nucleotides from DNA. This may be an important function for repair of DNA that has been damaged by radiation or chemicals. Again, the mechanism involves nick translation.

Limited proteolytic cleavage of **DNA polymerase I** yields a small N-terminal fragment (Mr = 35,000) and a large C-terminal fragment (Mr = 68,000). The large fragment, which contains the polymerase and 3'-5' exonuclease domains, is also called the Klenow fragment. The small fragment contains the 5' exonuclease domain. The molecule appears to bind DNA like a hand grabbing a bar.

See also: [E. coli DNA Polymerases](#), [Eukaryotic DNA Polymerases](#), [Figure 24.8](#), [Table 24.2](#), [Base Excision Repair](#)

INTERNET LINK: [DNA Replication Enzymes](#)

Figure 24.5: Nick translation.

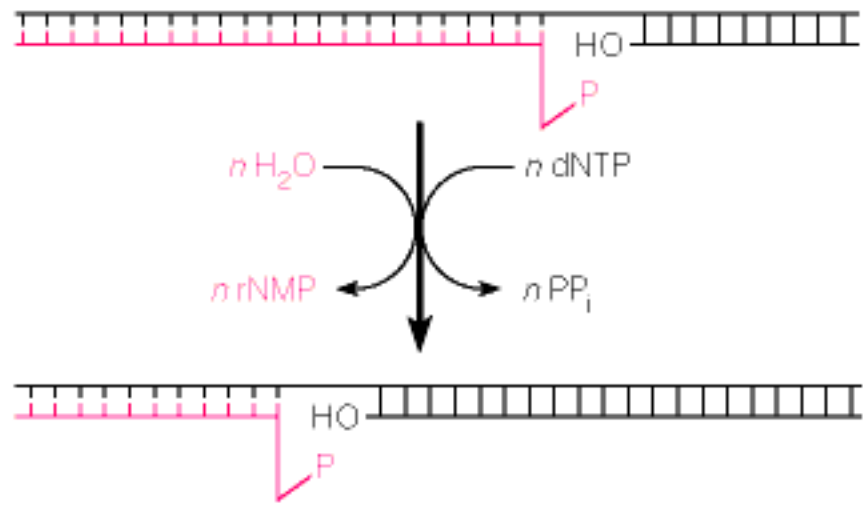
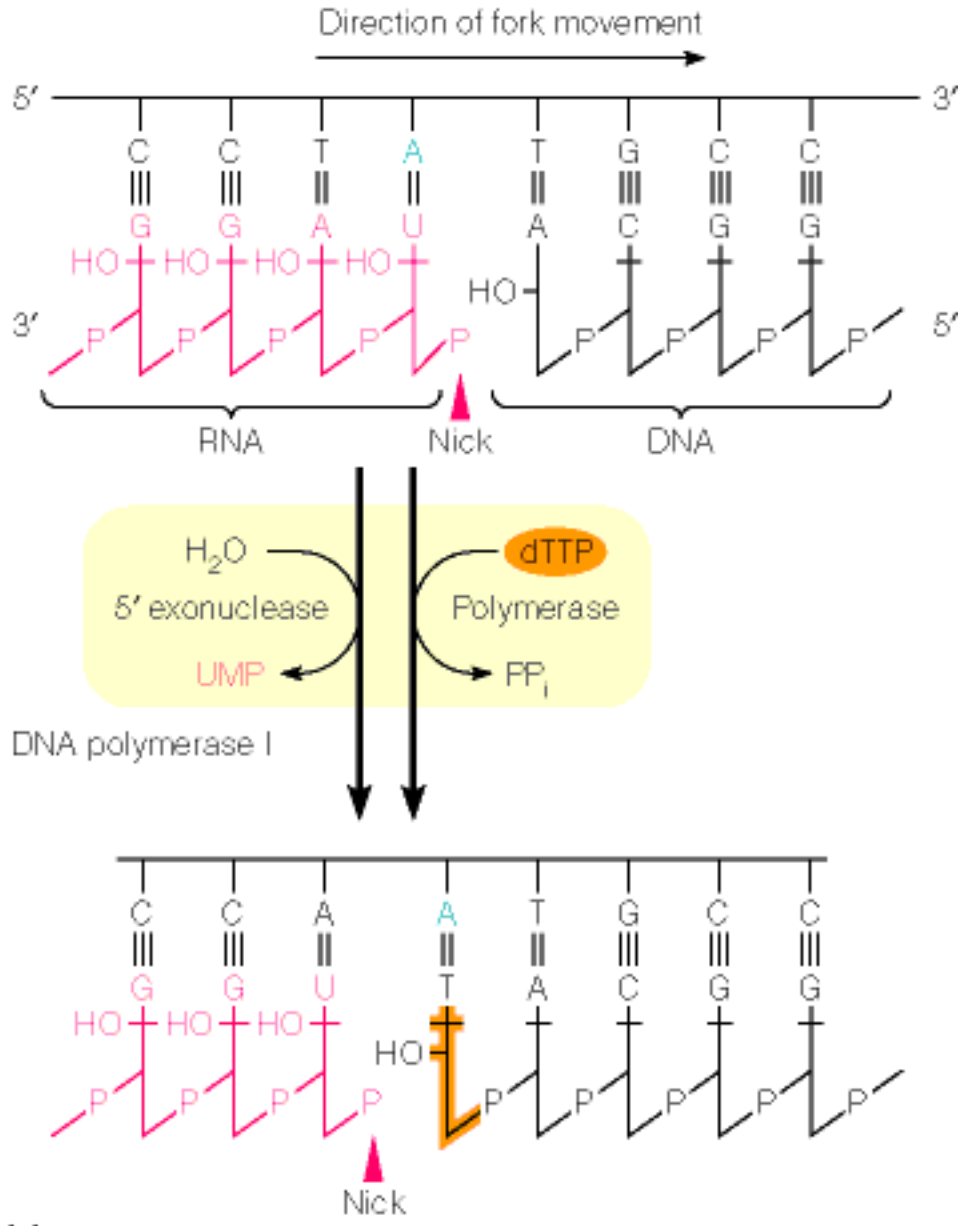

(b)

(b)

P

E. coli DNA Polymerases

The earliest studies of **DNA polymerases** began in the 1950s with Arthur Kornberg's discovery of **DNA polymerase** from *E. coli*. Three **DNA polymerases** are known in *E. coli*:

[DNA polymerase I](#)

[DNA polymerase II](#)

[DNA polymerase III](#)

DNA polymerases use deoxyribonucleoside triphosphates (dNTPs) to synthesize DNA sequences. dNTPs are activated compounds which are cleaved to generate a pyrophosphate and a deoxyribonucleoside monophosphate (dNMP) covalently linked into a DNA chain. dNMPs are added into the growing chain exclusively in the 5' to 3' direction. DNA polymerases require a "primer", which is a preexisting nucleic acid annealed at the site where replication is to begin ([Figure 24.15](#)). Primers of DNA, as well as RNA, can be extended by a **DNA polymerase**. In addition to the catalytic activity for polymerizing DNA, many **DNA polymerases** also contain one or more exonuclease activities. The function of these is described with each enzyme above. DNA polymerases can copy around a circular single-strand template, such as the DNA extracted from small bacteriophages (e.g., ϕ X174 or M13), as long as a primer is present. **DNA polymerases** cannot, however, join the ends. When the template is linear, polymerase copies only to the 5' end of the template and then it dissociates.

See also: [Eukaryotic DNA Polymerases](#), [Other Replication Proteins](#), [Figure 24.8](#), [Table 24.2](#)

INTERNET LINK: [DNA Replication Enzymes](#)

E. coli DNA Polymerase II

DNA Polymerase II - A combination of circumstances lead to the discovery of **polymerase II**. First, polymerase I did not have properties expected of a polymerase that replicated the *E. coli* genome. It was too slow and there were too many copies of it compared to the number of replication forks. In 1969, the isolation of an *E. coli* mutant deficient in DNA polymerase I activity lead to the detection of **DNA polymerases II** and III. It was not possible to detect these enzymes in normal cells due to the relatively large amounts of polymerase I. **Polymerase II** appears to participate in DNA repair synthesis and does not have a significant role in DNA replication.

See also: [E. coli DNA Polymerases](#), [Eukaryotic DNA Polymerases](#), [Figure 24.8](#), [Table 24.2](#)

INTERNET LINK: [DNA Replication Enzymes](#)

Eukaryotic DNA Polymerases

Mammalian cells contain four distinct **DNA polymerases**, while yeast cells contain at least five - α , β , γ , δ , and ϵ . A short summary of the properties of each enzyme is as follows:

α - Distinctive for containing a primase activity, it is also highly sensitive to an inhibitor called **aphidicolin**. Functions in lagging strand synthesis.

β - It has low processivity (i.e., it does not polymerize DNA for long periods of time). Functions in DNA repair. Low sensitivity to aphidicolin.

γ - A mitochondrial DNA polymerase. Low sensitivity to aphidicolin.

δ - It may be the principal leading strand polymerase. Requires a protein called proliferating cell nuclear antigen (PCNA) to carry out highly processive DNA synthesis *in vitro*. PCNA functions like the β clamp of ***E. coli* DNA Polymerase III holoenzyme**.

ϵ - Its function is not yet completely clear.

Table 24.3 also summarizes some known properties and cellular locations of these enzymes.

See also: ***E. coli* DNA Polymerases**, **Other Replication Proteins**, **Replication Complexes**

INTERNET LINK: **DNA Polymerase β Movies**

Aphidicolin

Aphidicolin is a product isolated from a fungus that inhibits replicative DNA synthesis in eukaryotes. Eukaryotic DNA polymerases α , δ , and ϵ are sensitized to **aphidicolin**, whereas polymerases β and γ are not.

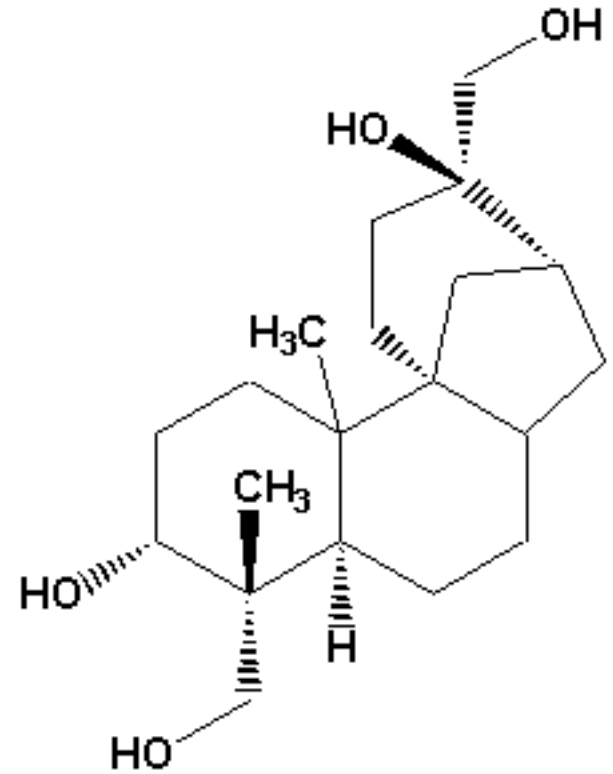

Aphidicolin

See also: [Eukaryotic DNA Polymerases](#)

E. coli DNA Polymerase III Holoenzyme

DNA polymerase III holoenzyme is a complex of several proteins. The *polC* gene encodes a single polypeptide chain of Mr of about 130,000. The protein has an intrinsic polymerase activity, but it is quite low. In cells, however, the PolC protein functions as part of a multiprotein aggregate called the **DNA polymerase III holoenzyme**. [Figure 24.19](#) shows that the holoenzyme contains 10 different polypeptide chains, each identified with a Greek letter. The functions of these units are summarized as follows:

α - PolC gene product. Has polymerase activity. Part of the core polymerase.

ϵ - Contains a 3'-5' exonuclease activity comparable to the 3'-5' exonuclease domain of polymerase I. Part of the core polymerase.

θ - Unknown function. Part of the core polymerase.

τ - This dimeric protein dimerizes the holoenzyme, holding leading and lagging strand polymerases together so both DNA strands are elongated at the replication fork.

χ - Mediates the switch from making RNA primers (with primase) to making DNA (with PolC).

β - Functions as a sliding clamp to hold the holoenzyme complex to DNA, making the enzyme very processive.

δ , δ' , κ , ρ , γ - This group of proteins is called the Υ complex (also called the clamp loader) ([Figure 24.21](#)). It is composed of one copy of all the proteins except Υ , of which there are 2 or 3 copies. The clamp loader wraps the β clamp onto the DNA. [Figure 24.21](#) shows some of the steps in this process.

See also: [E. coli DNA Polymerases](#), [Eukaryotic DNA Polymerases](#), [Figure 24.8](#), [Table 24.2](#)

INTERNET LINK: [DNA Replication Enzymes](#)

Figure 24.19: Subunit structure of the *E. coli* DNA polymerase III holoenzyme.

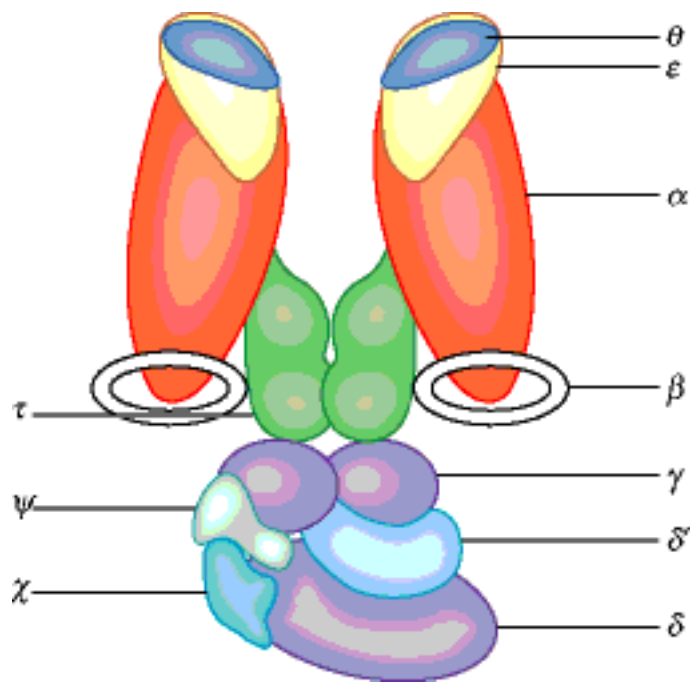

Modified from D. R. Herendeen and T. J. Kelly, *Cell* (1996) 84:5-8.

Figure 24.21: A scheme for action of the clamp loader.

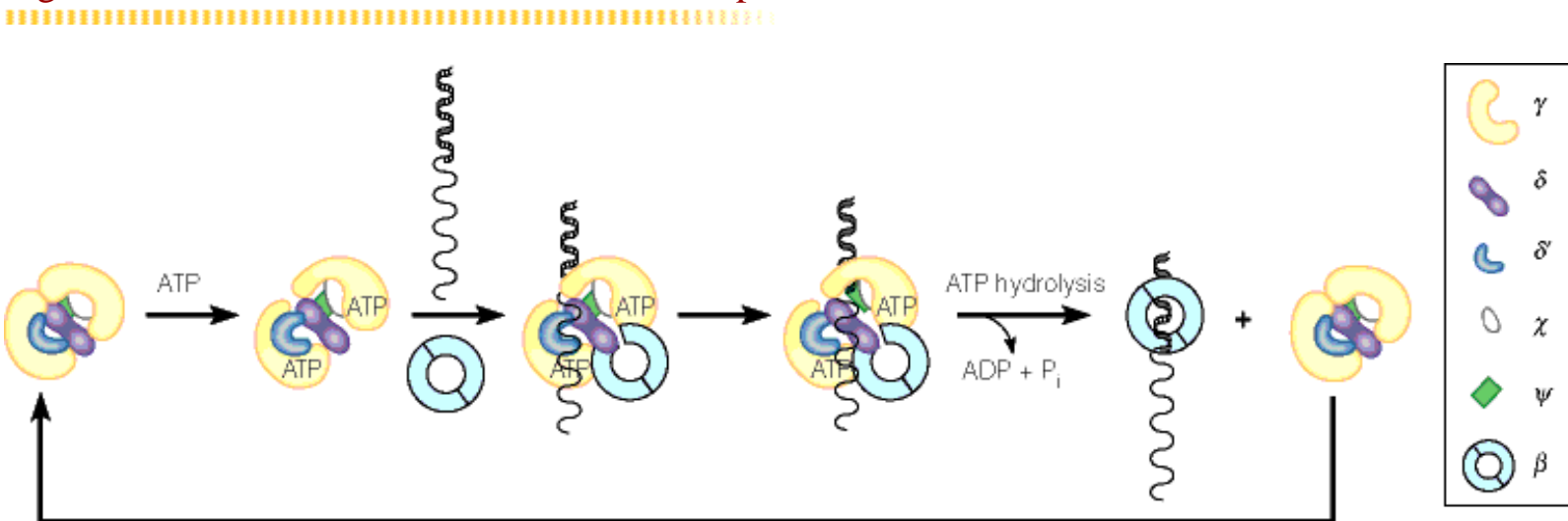

Courtesy of M. M. Hingorani and M. O'Donnell, J. Biol. Chem. (1998) 273:24550-24563. Reprinted by permission of the American Society for Biochemistry and Molecular Biology.

Figure 24.8: Partial genetic map of *E. coli*.

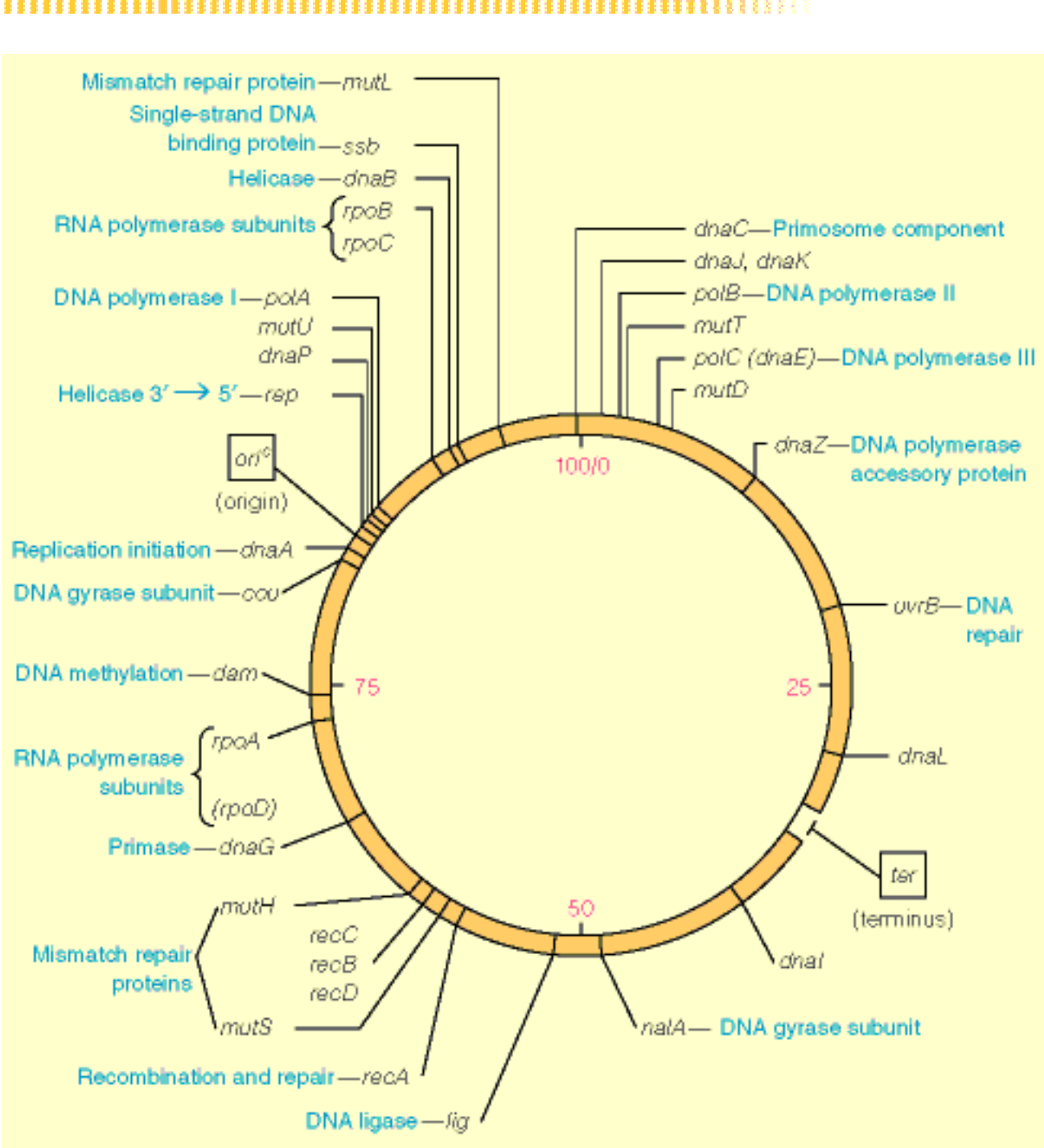

Table 24.2



Characteristic	Polymerase I	Polymerase II	Polymerase III
Structural gene	<i>polA</i>	<i>polB</i>	<i>polC</i>
Molecular weight	103,000	90,000	130,000
Number of molecules/cell	400	100	10
V_{\max} nucleotides/second	16–20	2–5	250–1000
3' exonuclease	Yes	Yes	No ^a
5' exonuclease	Yes	No	No
Processivity ^b	3–200	10,000	500,000
Mutant phenotype	^c UV ^s MMS ^s	None	<i>dnaI</i> ^s
Biological function	DNA repair, RNA primer excision	SOS DNA repair?	Replicative chain elongation

^aThe 3' exonuclease is carried on a separate polypeptide chain, the DnaQ protein.

^bThe number of nucleotides incorporated per encounter between polymerase and DNA (see page 894).

^cMMS (methylmethane sulfonate) is a DNA-alkylating agent.

Table 24.3



	α	β	γ	δ	ϵ
Cell compartment	Nucleus	Nucleus	Mitochondrion	Nucleus	Nucleus
Associated primase	Yes	No	No	No	No
Biological function	Lagging strand replication	DNA repair	Mitochondrial DNA replication	Leading strand replication	Replication
Number of subunits	4	1	4 (identical)	2	?
M_r of catalytic subunit, kilodaltons	160–185	40	125	125	210–230 or 125–140
K_m for dNTPs, μM	2–5	10^4	0.5	2–4	?
Processivity (inherent)	Moderate	Low	High	Low	High
Processivity (with PCNA)	Moderate	Low	High	High	High
3' exonuclease	No ^b	No	Yes	Yes	Yes
Sensitivity to 2',3'-dideoxy-NTPs	Low	High	High	Low	Moderate
Sensitivity to arabinosyl-CTP	High	Low	Low	High	?
Sensitivity to aphidicolin	High	Low	Low	High	High

^a K_m values for repair synthesis in permeabilized cells are much lower.

^bA cryptic, or masked, 3' exonuclease activity is associated with polymerase α from *Drosophila*.

Figure 24.28: Structure of the *E. coli* Rep helicase.

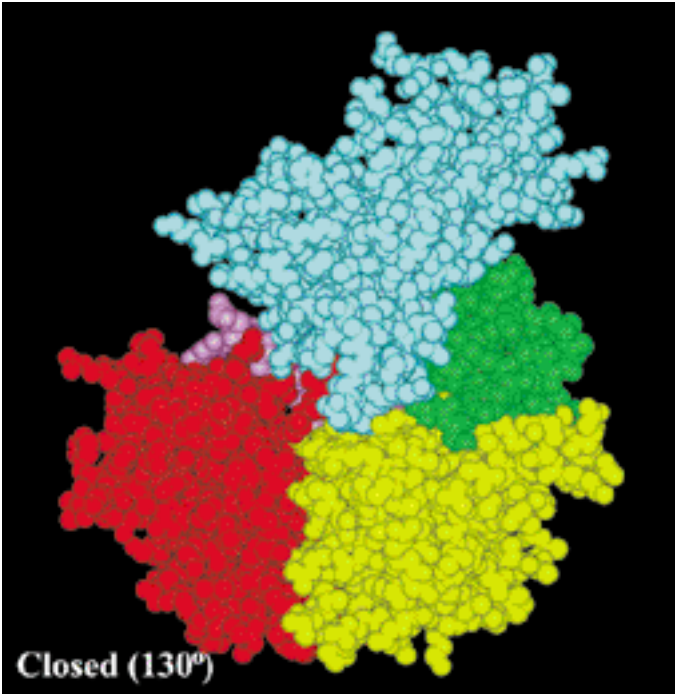
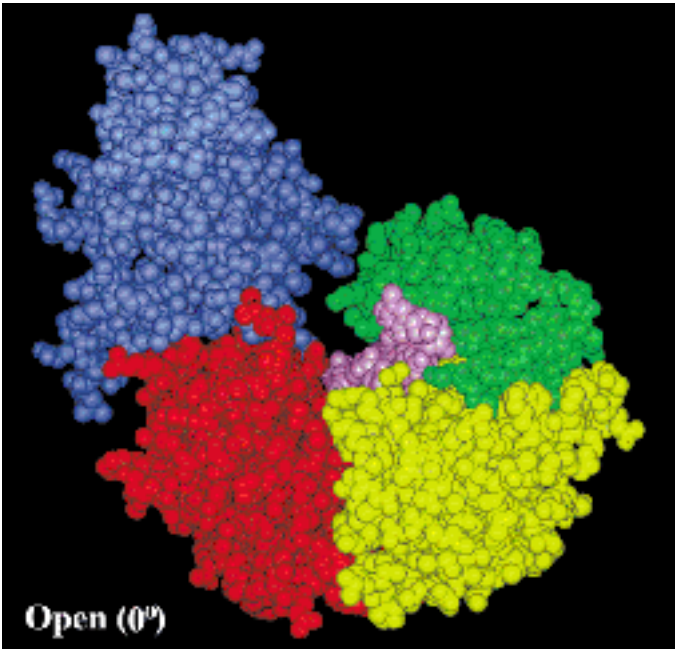

Courtesy of G. Waksman from S. Korolev et al., Cell (1997) 90:635-647. © Cell Press.

Topoisomerases

Bidirectional replication of the circular *E. coli* chromosome unwinds about 100,000 base pairs per minute. At 10 bp per turn, this is 10,000 turns of DNA per minute or over 160 per second. If there were nothing to relieve this stress, DNA would be a tangled mess in seconds. Relief of torsional stress is essential for DNA replication to occur. **Topoisomerases** are enzymes with a "swivel" mechanism that can relieve torsional stress.

There are two general classes of **topoisomerases**, type I and type II. Type I enzymes change the DNA linking number (see [here](#) for more on linking numbers) in units of 1, whereas type II enzymes change the linking number in units of 2. [Figure 24.30](#) shows the reaction mechanism of a type I **topoisomerase** and [Figure 24.31](#) shows the mechanism for a type II **topoisomerase**. *E. coli* contains four different **topoisomerases**. **Topoisomerases I and III** are both type I, whereas **topoisomerase II** (also called DNA gyrase) and **topoisomerase IV** are both type II.

DNA gyrase - plays the predominant role during replicative chain elongation. **DNA gyrase** both relieves stress ahead of the replication and introduces negative supercoils into newly synthesized DNA. The **gyrase A subunit** is the target for binding of [nalidixic acid](#), an inhibitor of DNA replication. Novobiocin binds to the B subunit and inhibits ATP cleavage.

Topoisomerase IV - plays a critical role in completion of a round of replication. [Figure 24.33](#) shows the types of topological interconversions catalyzed by type II topoisomerases and [Figure 24.34](#) shows how **Topoisomerase IV** decatenates replication involving a circular template.

Type I topoisomerases (Topoisomerases I and III) - Bind to DNA and break one strand. The 5' end of the strand is immobilized by a covalent bond between the DNA phosphate and a tyrosine. Rotation of the 3' end is followed by resealing.

See also: [Other Replication Proteins](#), [Replication Fork](#)

INTERNET LINKS:

1. [SCOP Type II Topoisomerases](#)
-

Circular DNA and Supercoiling

With respect to **circular DNAs and supercoiling**, students should note the following:

1. **Circular DNAs** have no free ends.
2. Enzymes called topoisomerases can take apart a **circular DNA**, introduce additional twists into it, and then reseal the structure (**Figure 4.24**). Adding twists to circular DNA introduces tension into the molecule. This kind of tension would not stay in linear DNA for very long because the force could be dissipated through the ends, and the DNA would "relax". The extra tension in circular **DNA** (or in linear DNA whose ends are anchored to prevent tension from being released) usually causes the molecule to writhe to alleviate the tension. Like an overwound rubber band, the circular DNA assumes a new shape, called a **supercoil**.
3. **Supercoiling** can be positive (additional twists added beyond the normal amount for linear DNA) or negative (reduced numbers of twists compared to linear DNA).

Figure 4.24 illustrates three kinds of **circular DNA**, unstrained circle, strained circle, and **supercoil**. Similarly, **Figure 4.18** shows an electron micrograph of a relaxed (unstrained) circle and two supercoiled circles. The unstrained circle contains the same number of twists as linear DNA. It is under no **superhelical tension**. To make the strained circle, one twist was removed (compared to linear DNA) and the resulting circular DNA is strained because it has the same number of base pairs (105), but fewer numbers of turns (twists). Thus, the strained circle has a higher number of base pairs per turn than the unstrained circle. To relieve the strain, the strained molecule can introduce another **superhelical** turn within itself, called a writhe.

After the writhe, the number of twists (turns) is 10 again so the number of base pairs per turn is 10.5 again, too. However, the three-dimensional shape of the molecule has changed in response to the initial change in the number of twists. The change in shape of the molecule can be observed as an alteration in the electrophoretic mobility. As noted above, the change in shape is called **supercoiling**. **Supercoiling** can come about by either adding or subtracting twists relative to unstrained circular DNA.

The linking number (L) is simply the algebraic sum of the number of twists (T) and writhes (W) of a molecule:

$$L = T + W$$

Consequently, the change in the linking number is also equal to the change in the twists and writhes for a molecule:

$$\Delta L = \Delta T + \Delta W.$$

The **superhelical density** is defined as $\Delta L/L_0$, where L_0 is the linking number of the DNA in its unstrained (relaxed state).

Many naturally occurring DNA molecules have **superhelical densities** of about -0.06. To get an idea of what this means, consider a hypothetical DNA molecule of 10,000 bp, which is in the "classical" B form, with 10.0 bp/turn. Then L_0 is 10,000 bp/(10.0 bp/turn), or 1000 turns. Each DNA strand crosses the other 1000 times in the relaxed circle. If the topoisomerase gyrase twisted the molecule to a **superhelical density** of -0.06, then $\Delta L = -0.06 L_0$, or $\Delta L = -60$. This change could be accommodated, for example, by the helix axis writhing about itself 60 times in a left-hand sense, which would correspond to $\Delta W = -60$, $\Delta T = 0$; the molecule would have 60 left-hand **superhelical turns**.

Alternatively, the twist of the molecule could change so that it had 940 turns in 10,000 bp ($T = 940$) or $10,000/940 = 10.64$ bp/turn. This would correspond to $\Delta W = 0$, $\Delta T = -60$. Although any combination of ΔT and ΔW that sums to -60 could occur, real molecules release strain mainly by writhing into **superhelical turns**, because it is easier to bend long DNA than it is to untwist it.

Besides writhing, unwinding DNA, cruciform formation (via palindromes), triple helix formation, and Z-DNA formation, can all reduce **superhelical tension**, too. For example, unwinding one repeat of the DNA helix (10 base pairs) is equivalent to $\Delta T = -1$. If one **superhelical turn** were removed at the same time ($\Delta W = +1$), then ΔL would remain unchanged. Similarly, converting from B- to Z-DNA causes a change of $\Delta T = -2$. Thus, two **superhelical turns** could be removed in this manner. There are likely physiological consequences of **superhelicity alteration**. For example, unwinding of duplex DNAs is a factor in both transcription and in DNA replication. Moreover, the A-T rich sequence regions near promoters of DNA (regions of DNA where copying of RNA occurs) allow for easier separation of strands of DNA and may well be easily opened by changes in **superhelical density**.

See also: [DNA](#), [Nucleic Acid Structures](#), [Structure of B-DNA](#), [Twists](#), [Linking Number](#), [Supercoiling](#), [Writhing](#), [Topoisomerases](#)

INTERNET LINK: [Supercoiling](#)

Figure 4.24: Forming a DNA supercoil.

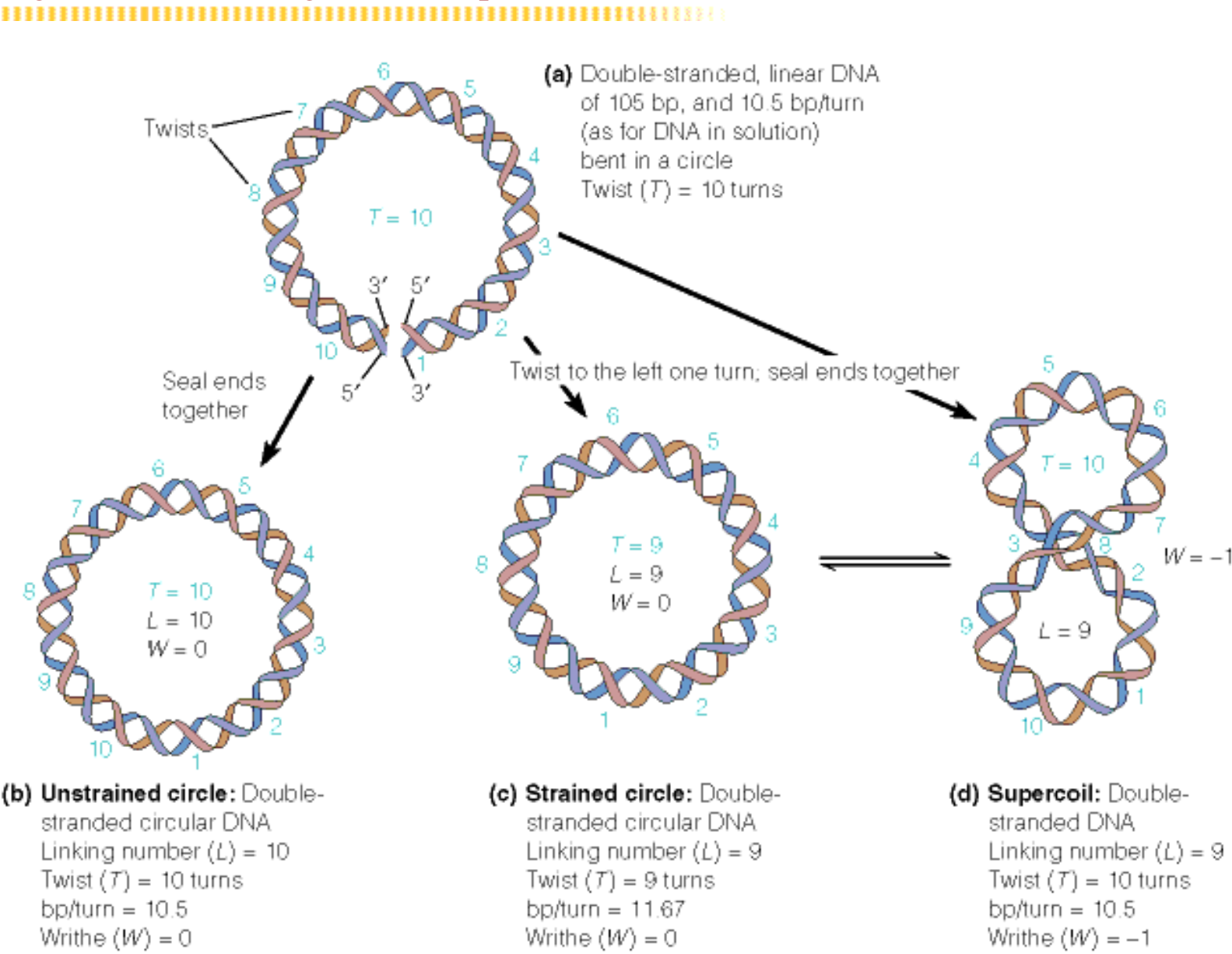

Figure 4.18: Relaxed and supercoiled DNA molecules.



Courtesy of Dr. D. A. Clayton.(a) Courtesy of Drs. D. Dressler and K. Koths; (b) Courtesy of R. Kavenoff, Designergenes Ltd./BPS; (c) © Biology Media/Photo Researchers.

Polynucleotide Structures

1. **B form:** Most **DNA** is in the **B form**. This so-called B-DNA (see [here](#)) is a right-handed helix. It predominates in an aqueous environment like that found in cells.
2. **A form:** A polynucleotide in the **A form** is a right-handed helix, too ([Figure 4.15d](#)). The **A form** is found in double-stranded **RNA** and in DNA-RNA hybrids.
3. **Z form:** Z-DNA is a left-handed helix found in polynucleotides with alternating purines and pyrimidines in each strand, as in the following:

5 ' CGCGCG3 '
3 ' GCGCGC5 '

In polynucleotides, the two most stable orientations of the bases with respect to their deoxyribose rings are called *syn* and *anti* (see [here](#)). In the *syn* orientation, the base is situated above the sugar ring. In the *anti* orientation, the base is turned away from the sugar ring. In B- and A-DNA, both the **purine** and **pyrimidine** bases assume the *anti* orientation. In Z-DNA, however, the pyrimidine bases are *anti*, but the purine bases are always *syn*. As a result, the phosphate backbone in Z-DNA forms a zigzag pattern ([Figure 4.26](#)), thus giving rise to the name Z-DNA.

4. The presence of self-complementary sequences (called palindromes) within a single strand of polynucleotide can cause the palindromic portion of it to form intramolecular base pairs ([Figure 4.27](#) and [Figure 4.28](#)). **tRNAs** and **rRNAs** have extensive base pairing of this type, although it can happen in DNA too.
5. Triple helices are unusual forms of DNA (called H-DNA) and RNA ([Figure 4.30](#)). Sequences favoring H-DNA include stretches of all pyrimidines on one strand and all purines on the complementary strand. This arrangement makes it possible to form a triple-stranded helix by doubling back. The triple helix of H-DNA consists of bases (e.g., adenine) each forming both a normal Watson-Crick with their complements (e.g., T) as well as an alternate form of base pair called a Hoogsteen pair with another complement (e.g., another thymine). [Figure 4.29](#) shows the base pairing in a T-A-T triplet, but triple helical RNAs of structure poly(U)-poly(A)-poly(U) can form in a similar fashion. Some tRNAs have triple helical regions, too

See also: [B-DNA](#), [Primary, Secondary, Tertiary Structure of Nucleic Acids](#), [Palindromes](#)

INTERNET LINKS:

1. [NDB Atlas of Nucleic Acid-Containing Structures](#)

2. [IMB-Jena Image Library](#)

Structure of B-DNA

Notable features of the structure of **B-DNA** (Figures [4.10](#), [4.11](#), and [4.15b](#)) include the following:

1. The two chains in the double helix are antiparallel (one goes 5' to 3' whereas the complementary strand goes 3' to 5').
2. Phosphate groups link together the sugar backbone via [phosphodiester bonds](#).
3. The bases on the two chains pair in a complementary fashion. [Adenine](#) (A) pairs with [thymine](#) (T) and [guanine](#) (G) pairs with [cytosine](#) (C).
4. [Hydrogen bonds](#) between bases (3 for G-C, 2 for A-T) hold the double helix together.
5. There are ten bases per turn of the helix, so the helix rotates 36° per base.
6. The rise of the double helix is the distance parallel to the axis of the helix from the level of one base to the level of the adjacent base. The pitch in **B-DNA** is 3.4 nm because the rise is 0.34 nm and there are ten base pairs per turn of the helix.
7. **B-DNA** possesses a major and a minor groove, as shown in [Figure 4.15b](#).

See also: [Polynucleotide Structures](#), [Stability of Nucleic Acid Secondary and Tertiary Structure, DNA](#)

INTERNET LINKS:

1. [NDB Atlas of Nucleic Acid-Containing Structures](#)
 2. [IMB-Jena Image Library](#)
 3. [IMB-Jena Nucleic Acid Conformations](#)
-

Figure 4.10: Fundamental elements of structure in the DNA double helix.

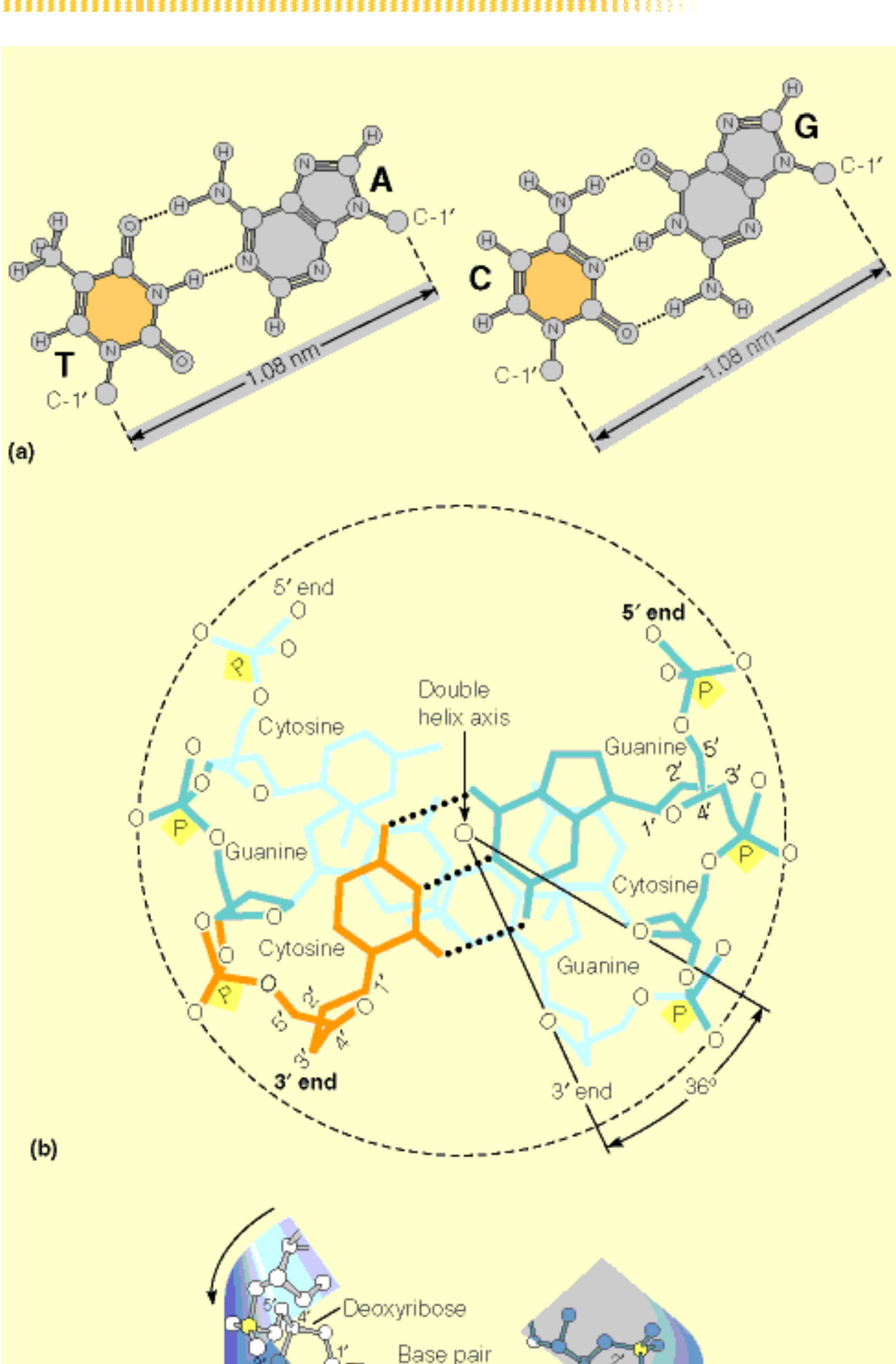

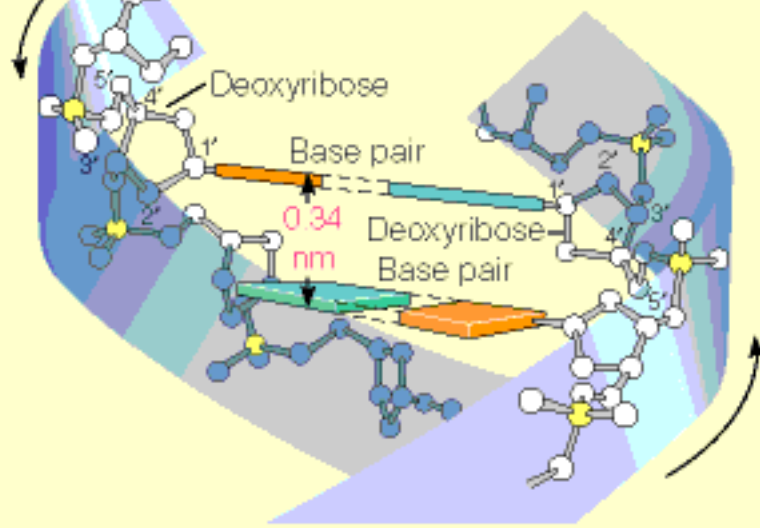



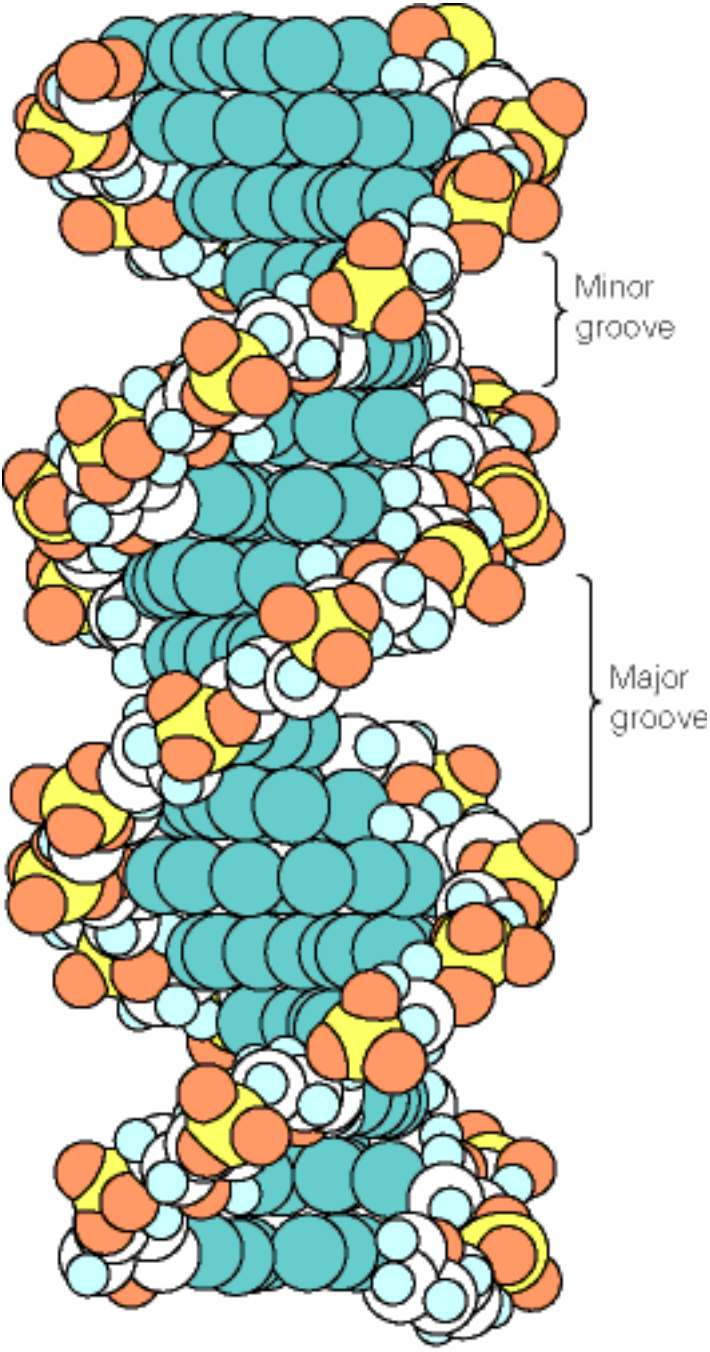

(c)

Figure 4.11: A space-filling model of DNA.



Key:

-  H
-  O
-  C in phosphate ester chain
-  C and N in bases

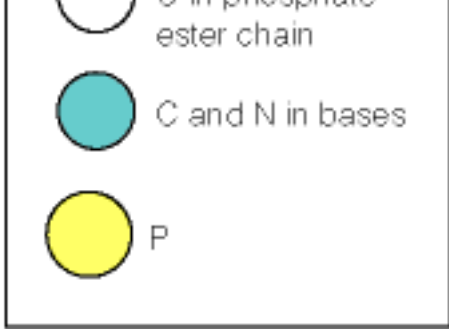

From J. D. Watson, N. H. Hopkins, J. W. Roberts, J. A. Steitz, and A. M. Weiner, *Molecular Biology of the Gene*, 4th ed. (Redwood City, CA: Benjamin/Cummings Publishing Co., 1987). © 1987 James D. Watson.

Figure 4.15: Comparison of the two major forms of DNA.

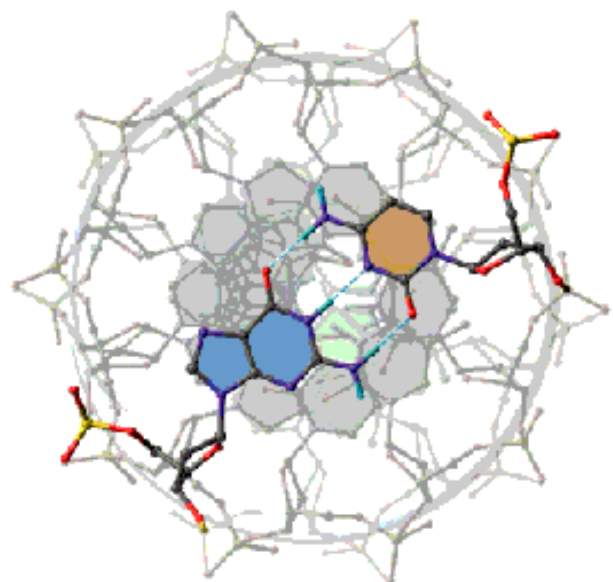

(a) B-DNA, end-on view

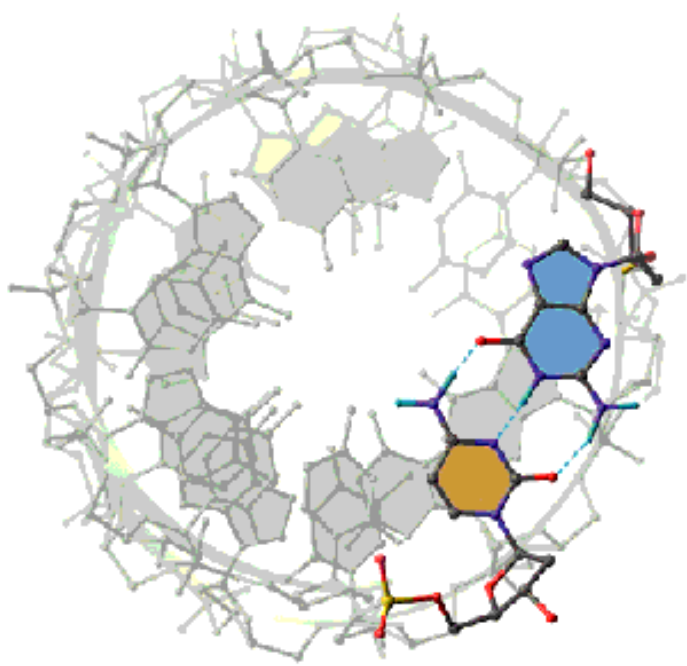

(c) A-DNA, end-on view

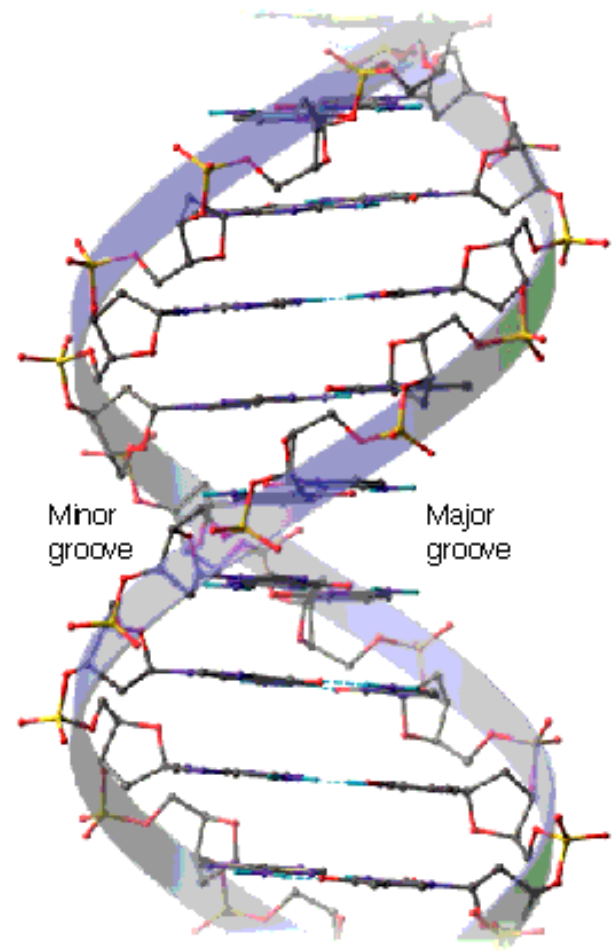

(b) B-DNA, side view

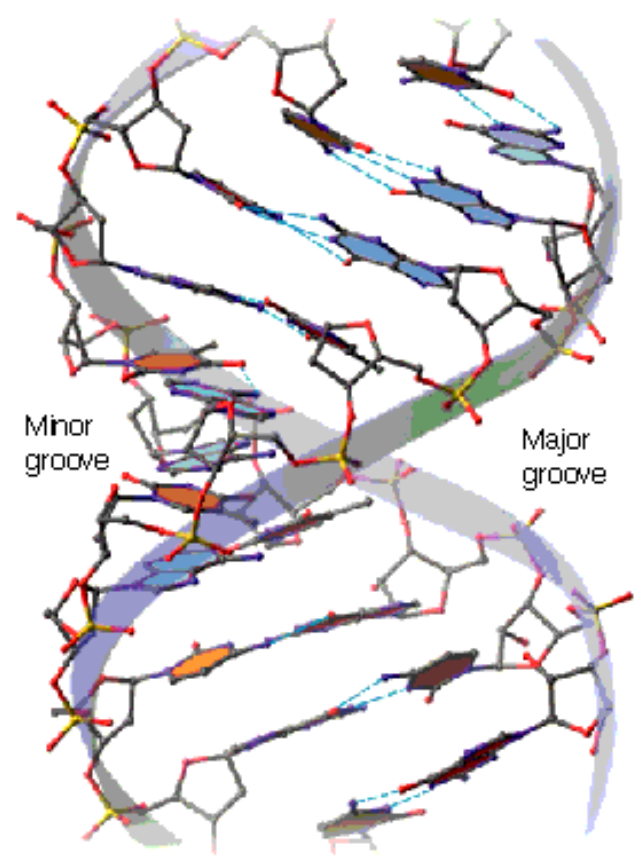

(d) A-DNA, side view

Phosphodiester Bonds



Adjacent monomer units in [nucleic acids](#) are connected via phosphate groups attached to the hydroxyl on the 5' carbon of one unit and the 3' hydroxyl of the next one. This linkage is called a phosphodiester bond ([Figure 4.1](#)).

1. **Phosphodiester bonds** in nucleic acids are very stable to hydrolysis in the absence of a catalyst (such as an acid or a nuclease).
2. Synthesis of a **phosphodiester bond** in nucleic acids requires energy input. As a result, the nucleoside monophosphates in nucleic acids are built up from hydrolysis of nucleoside triphosphates. Cleaving a pyrophosphate from a nucleoside triphosphate yields a nucleoside monophosphate and enough free energy to make the formation of polynucleoside monophosphates (i.e., polynucleotides) thermodynamically favorable.

See also: [Nucleoside and Nucleotide Naming](#), [Nucleotide Properties](#), [DNA](#), [RNA](#)

Nucleic Acids

Nucleic Acids - In order to duplicate themselves (replicate), cells have to carry the information describing how to do so.

The nucleic acids, **DNA** (deoxyribonucleic acid) and **RNA** (ribonucleic acid), are the only known molecules in the cell that carry such information.

All of a cell's information is contained within the **DNA**.

DNA is, of course, a component of **chromosomes**.

There are three primary types of **RNA** - messenger RNA (**mRNA**), transfer RNA (**tRNA**), and ribosomal RNA (**rRNA**).

RNAs are made by copying a portion of the DNA and are largely involved in making proteins, though in eukaryotes, another minor type of RNA, called small nuclear RNA (snRNA) is involved in processing of the other three types of RNA (see **here**).

See also: **[Nucleic Acid Sequences](#)**, **[Primary, Secondary, Tertiary Structure of Nucleic Acids](#)**, **[History of DNA](#)**, **[Structure of B-DNA](#)**

Chromosomes

Bacterial chromosome - Almost all of the DNA of a typical prokaryote like *E. coli* is contained in a single, large, supercoiled circular DNA molecule, with a minor fraction present in small plasmids. It is complexed with proteins and exists free in the cytosol, although it is attached at one or more points to the cell membrane.

Eukaryotic chromosomes - The typical eukaryotic cell's genome is divided into several or many chromosomes, each of which contains a single, very large, linear DNA molecule. These DNA molecules are commonly of the order of 10^7 to 10^9 bp in length, though the size does vary. The number of eukaryotic chromosomes ranges from 1 (in an Australian ant) to 190 (in a species of butterfly). In nondividing cells, the chromosomes are segregated within the nucleus as an entangled mass of fibers of a DNA-protein complex called **chromatin**. During mitosis, the nuclear envelope breaks down and the diploid chromosomes condense into compact structures.

Ploidy - Most prokaryotes are haploid, containing only one copy of their chromosome, but most eukaryotic cells are diploid, carrying two copies of each chromosome. Some eukaryotic cells are highly polyploid, carrying many copies of each chromosome. The polytene chromosomes of the salivary glands of fruit flies provide a dramatic way to visualize the linearity of gene arrangements. In a polytene chromosome, multiple copies of the DNA, and its associated proteins, are arranged side by side in exact register. The linear array of light-staining and dark-staining bands can be correlated with the linear arrangement of genes on the chromosome.

Considerations in eukaryotic chromosomes - The enormous amount of DNA in eukaryotic cells poses the following obstacles to cells:

1. **Compaction** - The length of the total DNA content of a human cell is nearly 3 meters, yet it must be packed into a nucleus about 10^{-5} m in diameter.
2. **Selective transcription** - In a typical differentiated eukaryotic cell, only a small fraction of the DNA (5%-10%) is ever transcribed. Much is nontranscribable. Many genes that do undergo transcription do so only in certain cell lines in particular tissues, and then often only under special circumstances. To maintain and regulate such complex programs of selective transcription, the accessibility of the DNA to **RNA Polymerases** must be under strict control.

Both compaction and the control of gene expression in eukaryotes are achieved by having the DNA complexed with a set of special proteins to form the protein-DNA complex called chromatin.

See also: [Nucleosomes](#), [Higher Order Chromatin Structure](#)

INTERNET LINK: [Eukaryotic Chromosome Structure](#)

Chromatin

Compaction of the large DNA molecules and the control of gene expression in eukaryotes are achieved by having the DNA complexed with a set of special proteins to form the protein–DNA complex called **chromatin**. The DNA-binding proteins of **chromatin** fall into the following two classes.

1. Histones - This class of DNA-binding proteins includes five types of protein, whose properties are outlined in [Table 28.1](#). All histones are small, very basic proteins rich in lysine and arginine. Some have been remarkably well conserved in amino acid sequence throughout evolution. Histone H4, for example, shows only two substitutions between humans and peas and only eight substitutions between humans and yeast. The histones are the basic building blocks of chromatin structure. The nucleoids of prokaryotic cells also have proteins associated with DNA, but these proteins are quite different from the histones and do not seem to form a comparable **chromatin** structure. Thus, a histone-containing **chromatin** structure is a uniquely eukaryotic feature. In all kinds of eukaryotic nuclei, the histones are present in an equal weight amount with DNA, and histones H2A, H2B, H3, and H4 are always found in equimolar quantities.

2. Nonhistone chromosomal proteins - The histones are accompanied by a much more diverse group of DNA-binding proteins called nonhistone chromosomal proteins. The total amount of these proteins varies greatly from one cell type to another, ranging from about 0.05 to 1 g/g DNA. They include a bewildering variety of proteins, such as polymerases and other nuclear enzymes, hormone receptor proteins, and regulatory proteins of many kinds. It is possible to count, on two-dimensional gels, approximately 1000 different nonhistone chromosomal proteins in a typical eukaryotic nucleus.

The precise role of histones was not understood until about 1974. Then, research in a number of laboratories showed that these proteins combine in a specific way to form a repeating element of **chromatin** structure, called the nucleosome.

See also: [Chromosomes](#), [Nucleosomes](#), [Higher Order Chromatin Structure](#)

INTERNET LINKS:

1. [Virtual Tour of the Nucleosome](#)

Figure 28.1: Genome size.

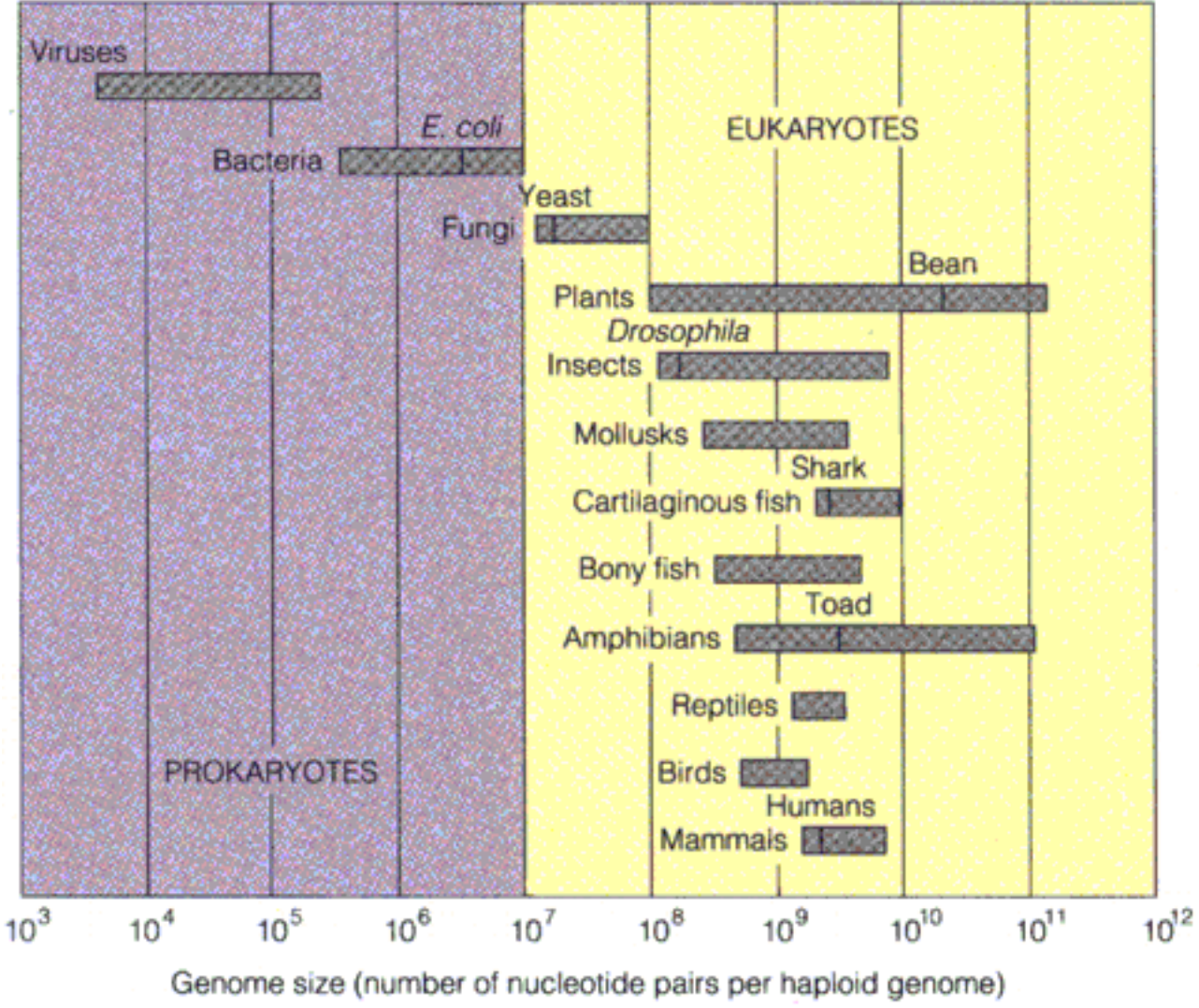

Nucleosomes

Figure 28.11 provides an overall view of the fundamental elements of **chromatin** structure.

Experimental Evidence - Three experimental observations have revealed that the structure of chromatin is regular and repeating. The repeating element is called a **nucleosome**. The observations are as follows:

1. If naked DNA (that is, DNA that is not protein-complexed) is partially digested with a nonspecific endonuclease that randomly cuts double strands, a broad smear of polynucleotide fragments is observed in an electrophoresis gel. If the same experiment is conducted with chromatin, or even with whole nuclei (which the nuclease can easily penetrate through the nuclear pores), the random DNA cleavage yields a series of bands that are multiples of approximately 200 base pairs. This indicates that "naked" DNA is present only at regularly spaced points.
2. Electron micrographs of extended chromatin fibers reveal a regular "beaded" pattern in the chromatin structure, with one bead about every 200 bp.
3. If nuclease digestion of chromatin is continued, it slows down and nearly stops when about 30% of the DNA had been consumed. The remaining protected DNA is present in particles corresponding to the beads seen in the electron micrograph.

Nucleosome structure - The bead particles are **nucleosomes** (or more precisely, nucleosomal core particles). They have a simple, definite composition that is practically invariant over the whole eukaryotic kingdom. Both **nucleosomes** and **nucleosome** histone cores have been crystallized.

1. **Nucleosomes** always contain 146 bp of DNA, wrapped about an octamer of histone molecules--two each of H2A, H2B, H3, and H4. This composition explains the equal amounts of each of the four histones in chromatin.
2. The DNA lies on the surface of the histone octamer and makes about 1.75 left-hand superhelical turns about it. The structure of the octamer provides a helical "ramp" upon which the DNA is bound. Analysis of high-resolution data reveals a common histone structure called the "histone fold."

Other aspects of structure - Although the **nucleosome** itself is a nearly invariant structure in eukaryotes, the length of DNA between **nucleosomes** may vary from about 20 bp to over 100 bp. Exactly what determines the arrangement of **nucleosomes** along the DNA is still not understood completely. However, it is now clear that at least some **nucleosomes** occupy defined positions. For

example, the **internucleosomal**, or linker, DNA is occupied by the H1-type (very lysine-rich) histones and nonhistone proteins.

See also: [Higher Order Chromatin Structure](#)

INTERNET LINKS:

1. [The Role of Chromatin Structure in Transcription](#)
 2. [Virtual Tour of the Nucleosome](#)
 3. [The Nucleus](#) (slow)
-

Figure 28.11: The elements of chromatin structure.

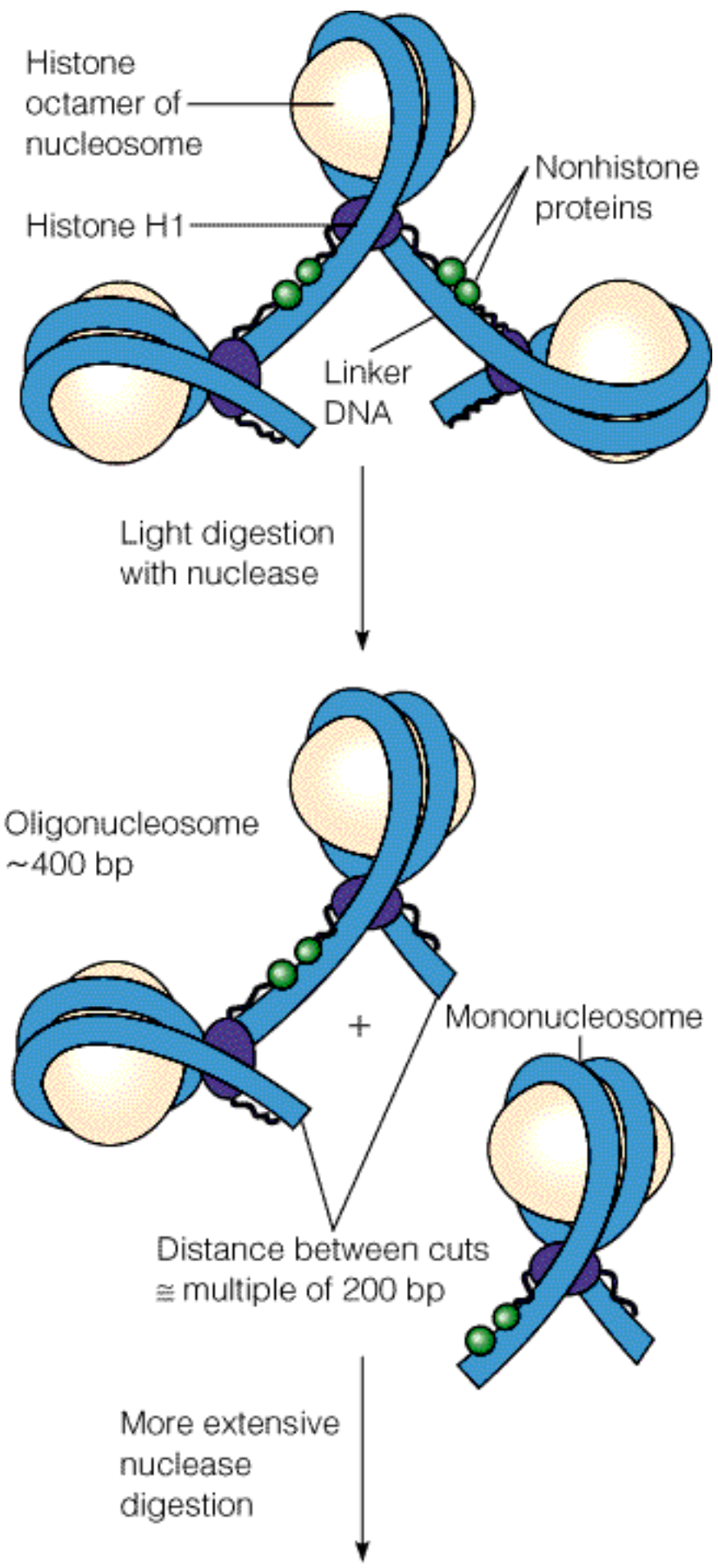

nuclease
digestion



Released
nucleosome
core particle
(146 bp DNA,
8 histones)

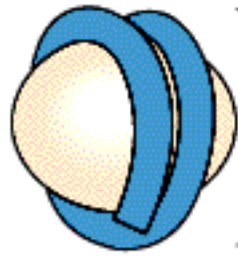

11.0 nm

+

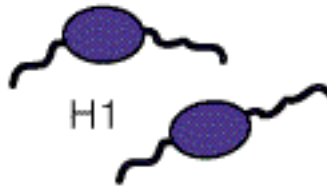

H1

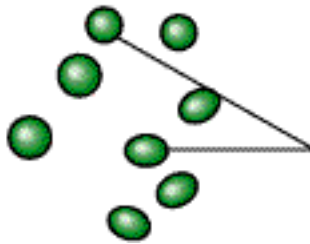

Nonhistone
proteins

Higher Order Chromatin Structure



Chromatin compaction - Wrapping DNA about histone cores to form nucleosomes (see [here](#)) accomplishes part of the compaction necessary to fit the long eukaryotic DNA into the nucleus. However, much of the chromatin in the nucleus is even more highly compacted. The next stage in compaction involves folding the beaded fiber into a thicker fiber like that shown in [Figure 28.12](#). These fibers may be further folded on themselves to make the thicker chromatin fibers visible in both metaphase chromosomes and the nuclei of nondividing (interphase) cells.

Metaphase scaffolding - Dye staining of metaphase chromosomes from a particular organism gives a reproducible banding pattern. *In situ* hybridization methods show that particular DNA sequences are always located at the same places in specific [chromosomes](#). Some kind of regular folding must preserve this order. Recent evidence indicates that when metaphase chromosomes are treated with polyanions to strip off the [histones](#) and loosely bound nonhistone proteins, the DNA strands emerge as enormous loops from a scaffold of tightly bound protein. Individual loops may range up to 100,000 bp in length--about the size of the β globin gene cluster, for example. Approximately 1000 such loops exist in the average chromosome.

Interphase scaffolding - Evidence also exists for a similar but more diffuse scaffold in the interphase nucleus. Removal of histones and weakly bound nonhistone proteins from intact nuclei by high salt concentrations or detergents, together with digestion of most of the DNA by nucleases, leaves a protein structure that has been called the nuclear scaffold, or nuclear matrix ([Figure 28.12](#)). It includes the laminar shell that lines the inside of the nuclear membrane, plus a network of fine fibers that seem to extend throughout the nucleus. When the chemical dissection is done gently to remove the histones and most other proteins, the DNA connections to the nuclear matrix are undisturbed. Cleavage of the DNA with restriction endonucleases leaves specific fragments of DNA attached to the nuclear matrix. These fragments are spaced at rather long intervals along the genome and contain characteristic matrix attachment regions (MARs). It appears that groups of coordinately expressed genes often lie between adjacent MARs, as [Figure 28.13](#) illustrates for the repeated histone gene clusters in *Drosophila*.

Scaffold proteins - Proteins that form the scaffold from which the loops extend include topoisomerases. [Topoisomerase](#) molecules at the base of a loop might bring about changes in the supercoiling on that particular loop in addition to the coiling imposed by the nucleosomes. Changes in supercoiling may aid in chromosome condensation and seem to be essential during replication and transcription. The structure of chromatin is likely dynamic, changing locally as the DNA is replicated (see [here](#)) or transcribed (see [here](#)).

Heterochromatin/Euchromatin - Some loop domains, those involving the nontranscribed genes of a particular cell, may be permanently coiled into 30-nm fibers and perhaps supercompacted into even

higher-order coiling. Such regions could correspond to the highly condensed regions of heterochromatin long recognized by cytologists. The more-open chromatin regions, called euchromatin, may then correspond to relaxed domains within which transcription can occur.

See also: [Nucleosomes](#), [Chromatin](#), [Chromosomes](#), [Topoisomerases](#)

Figure 28.12: Levels of chromatin structure.

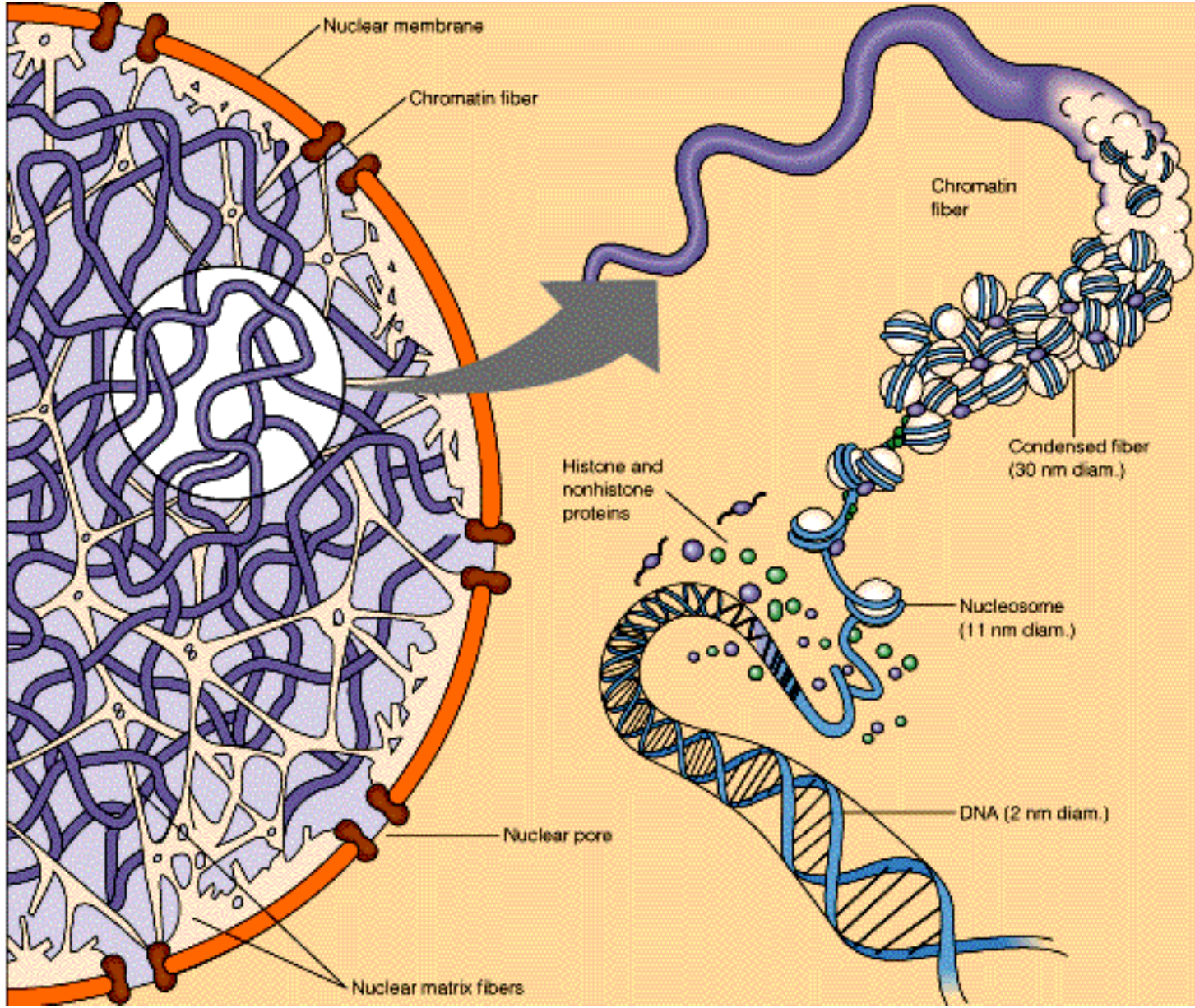

Histones

Histones are a class of DNA-binding proteins that includes five types of protein. Their properties are outlined in [Table 28.1](#). All **histones** are small, very basic proteins rich in [lysine](#) and [arginine](#). Some have been remarkably well conserved in amino acid sequence throughout evolution. **Histone H4**, for example, shows only two substitutions between humans and peas and only eight substitutions between humans and yeast. The **histones** are the basic building blocks of [chromatin](#) structure. The nucleoids of prokaryotic cells also have proteins associated with DNA, but these proteins are quite different from the **histones** and do not seem to form a comparable chromatin structure. Thus, a **histone**-containing chromatin structure is a uniquely eukaryotic feature. In all kinds of eukaryotic nuclei, the **histones** are present in an equal weight amount with DNA, and **histones H2A, H2B, H3, and H4** are always found in equimolar quantities.

See also: [Figure 28.28](#), [Nucleosomes](#), [Higher Order Chromatin Structure](#)

Lysine

Lysine is an α amino acid found in proteins. In mammals, **lysine** is an essential amino acid, meaning it must be present in the diet. **Lysine's** nonpolar side chain classifies it as a basic amino acid.

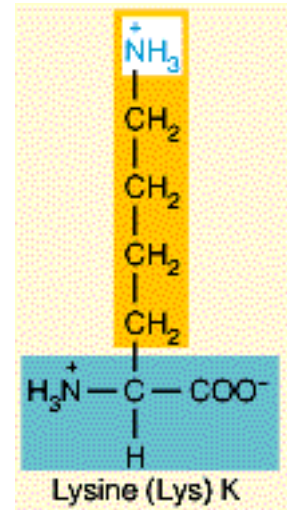

The basic amino acids are strongly polar, and as a consequence, they are usually found on the exterior surfaces of proteins, where they can be hydrated by the surrounding aqueous environment.

One Letter Code	Three Letter Code	Molecular Wt. (Daltons)	Genetic Code Codons
K	LYS	128.18	AAA, AAG

See also: [Table 5.1, Amino Acids](#), [Genetic Code](#), [Metabolism of Valine, Leucine, Isoleucine, and Lysine](#), [Essential Amino Acids](#)

INTERNET LINK: [Lysine Biosynthesis](#)

Metabolism of Valine, Leucine, Isoleucine, and Lysine

The amino acids valine, leucine, isoleucine, and lysine are essential for mammals and are synthesized primarily in plant and bacterial cells. None of these amino acids is known to play significant roles other than as protein constituents and as substrates for their own degradation.

Valine, leucine, and isoleucine - The synthetic pathway from **threonine** and **pyruvate** to valine, leucine and isoleucine is outlined in **Figure 21.26**. The last four reactions in the biosynthesis of **valine** and **isoleucine** are catalyzed by the same four enzymes. Threonine dehydratase, which catalyzes the first step in conversion of threonine to **isoleucine**, is inhibited by **isoleucine**. **Leucine, isoleucine, and valine** are all catabolized via transamination followed by oxidative decarboxylation of the respective keto-acids (see **here**) and oxidation. The oxidation is similar to fatty acid oxidation, except for a debranching reaction for each intermediate.

Lysine - **Lysine** has two distinct biosynthetic pathways, the diaminopimelic acid pathway and the α -aminoadipic acid pathway. The diaminopimelic acid pathway operates in bacteria, some lower fungi, algae, and higher plants. It begins with condensation of **pyruvate** with **aspartate**/ **β -semialdehyde** and ends with decarboxylation of diaminopimelate (see **here**). Diaminopimelate is an important constituent of bacterial cell walls. The α -aminoadipic acid pathway is less widespread and functions in other lower fungi, in higher fungi, and in the protist *Euglena*.

See also: [Metabolism of Serine, Glycine, and Threonine](#), [Essential Amino Acids](#)

INTERNET LINKS:

1. [Val, Leu, Ile Biosynthesis](#)
 2. [Lysine Biosynthesis](#)
-

Valine

Valine is an α **amino acid** found in proteins. In mammals, **valine** is an essential amino acid, meaning it must be present in the diet. **Valine's** isopropyl side chain classifies it as an aliphatic amino acid.

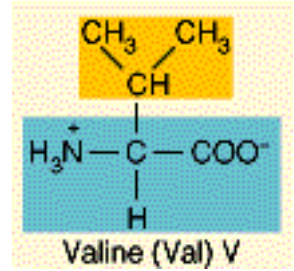

The more hydrophobic amino acids, like **valine**, are usually found in the interior of a protein molecule, where they are shielded from water.

One Letter Code	Three Letter Code	Molecular Wt. (Daltons)	Genetic Code Codons
V	VAL	99.14	GUU, GUC, GUA, GUG

See also: [Table 5.1, Genetic Code](#), [Metabolism of Valine, Leucine, Isoleucine, and Lysine](#), [Essential Amino Acids](#)

INTERNET LINK: [Val, Leu, Ile Biosynthesis](#)

Leucine

Leucine is an α amino acid found in proteins. In mammals, **leucine** is an essential amino acid, meaning it must be present in the diet. **Leucine's** side chain classifies it as an aliphatic amino acid.

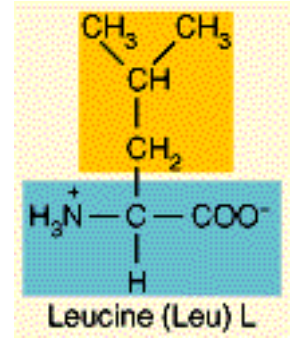

The more hydrophobic amino acids, like **leucine**, are usually found in the interior of a protein molecule, where they are shielded from water.

One Letter Code	Three Letter Code	Molecular Wt. (Daltons)	Genetic Code Codons
L	LEU	113.17	CUU, CUC, CUA, CUG, UUA, UUG

See also: [Table 5.1, Amino Acids](#), [Genetic Code](#), [Metabolism of Valine, Leucine, Isoleucine, and Lysine](#), [Essential Amino Acids](#)

INTERNET LINK: [Val, Leu, Ile Biosynthesis](#)

Isoleucine

Isoleucine is an α [amino acid](#) found in proteins. In mammals, **isoleucine** is an essential amino acid, meaning it must be present in the diet. **Isoleucine's** nonpolar side chain classifies it as an aliphatic amino acid.

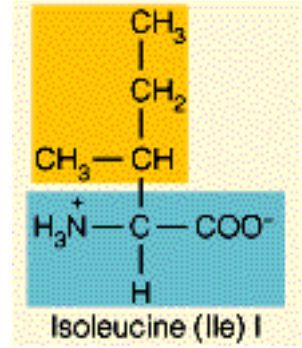

The more hydrophobic amino acids, like **isoleucine**, are usually found in the interior of a protein molecule, where they are shielded from water.

One Letter Code	Three Letter Code	Molecular Wt. (Daltons)	Genetic Code Codons
I	ILE	113.17	AUU, AUC, AUA

See also: [Table 5.1](#), , [Genetic Code](#), [Metabolism of Valine, Leucine, Isoleucine, and Lysine](#), [Essential Amino Acids](#)

INTERNET LINK: [Val, Leu, Ile Biosynthesis](#)

Figure 21.26: Biosynthesis of valine and isoleucine.

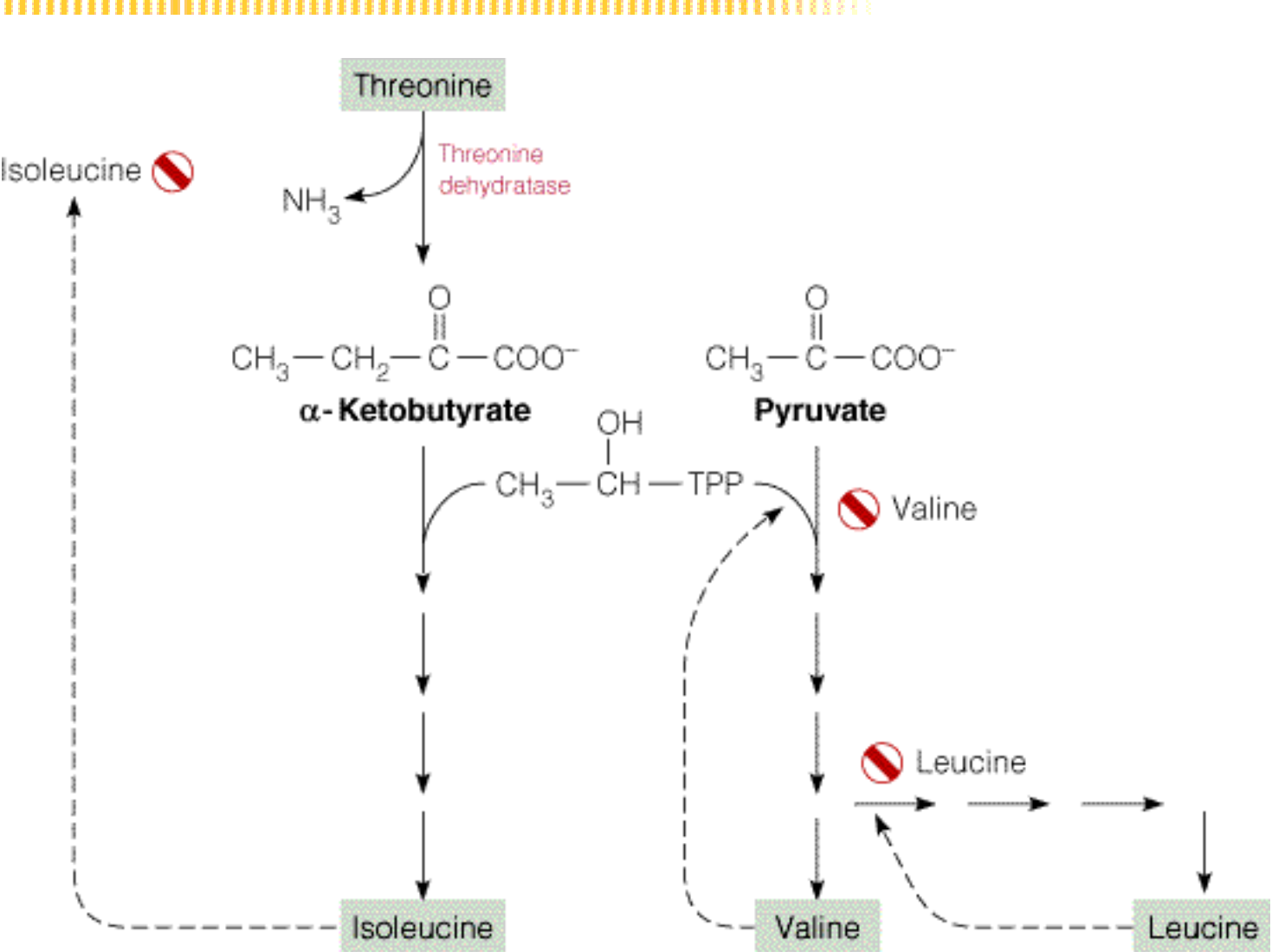

Unnumbered Item

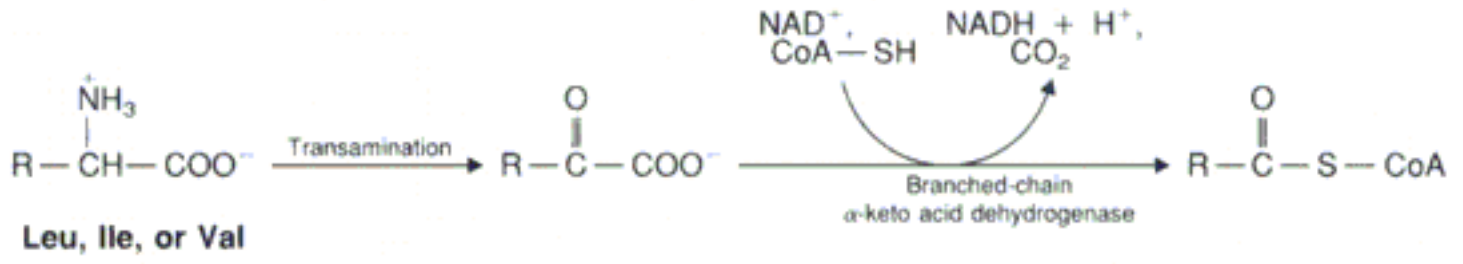

Aspartic β -Semialdehyde

Aspartic β -semialdehyde (**aspartate β -semialdehyde**) is an intermediate in aspartate metabolism (see [here](#)).

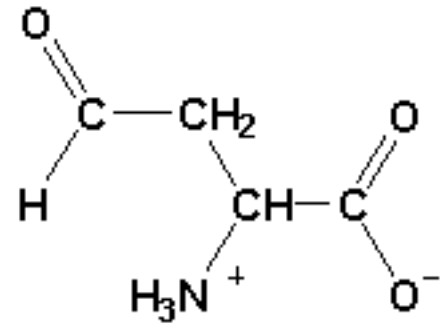

Aspartic beta-semialdehyde

β -Aspartyl Phosphate + **NADPH** + H⁺ \rightleftharpoons **Aspartic β Semialdehyde** + **NADP⁺** + Pi (catalyzed by **β Aspartate Semialdehyde Dehydrogenase**)

Aspartic β -Semialdehyde also participates in the reaction below that leads ultimately to lysine or to homoserine and methionine:

Aspartic β Semialdehyde + **NADPH** + H⁺ \rightleftharpoons **Homoserine** + **NADP⁺** (catalyzed by Homoserine Dehydrogenase).

See also: [Citric Acid Cycle Intermediates in Amino Acid Metabolism](#), [Metabolism of Valine, Leucine, Isoleucine, and Lysine](#), [Aspartate](#), [Lysine](#), [Homoserine](#), [Methionine](#)

Unnumbered Item

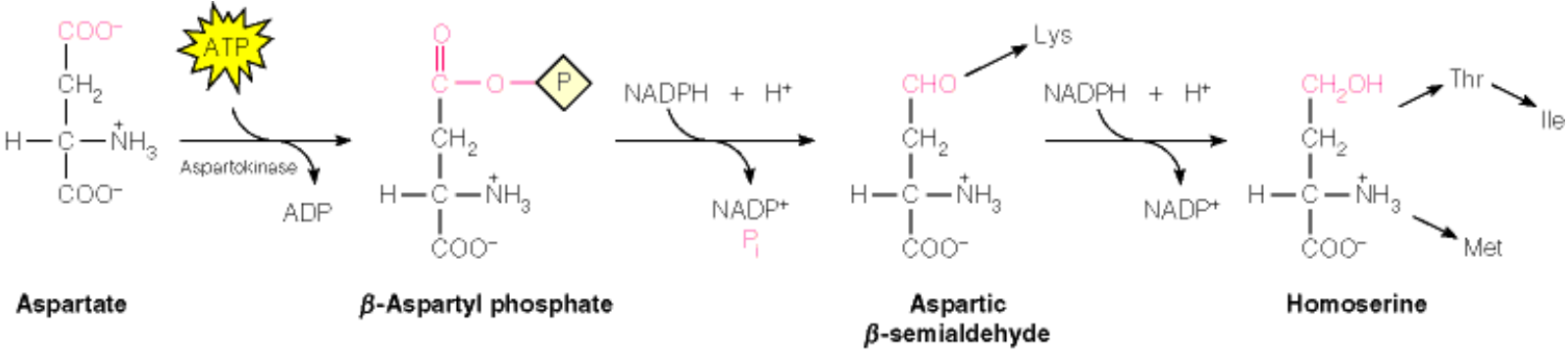

β -Aspartyl-Phosphate

β -Aspartyl-phosphate is an intermediate in the conversion of [aspartate](#) to [homoserine](#) (see [here](#)) in the pathway leading to biosynthesis of [threonine](#), [isoleucine](#), and [methionine](#).

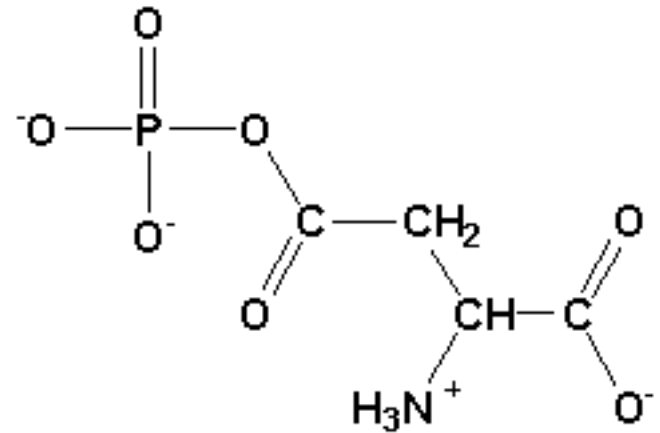

Beta-aspartyl-phosphate

1. [Aspartate](#) + [ATP](#) \rightleftharpoons β -Aspartyl-Phosphate + [ADP](#) (catalyzed by [Aspartokinase](#))
2. β -Aspartyl Phosphate + [NADPH](#) + H⁺ \rightleftharpoons [Aspartic \$\beta\$ Semialdehyde](#) + [NADP⁺](#) + Pi (catalyzed by [\$\beta\$ Aspartate Semialdehyde Dehydrogenase](#)).

See also: [Metabolism of Serine, Glycine, and Threonine](#), [Metabolism of Valine, Leucine, Isoleucine, and Lysine](#), [Metabolism of Sulfur-Containing Amino Acids](#)

Figure 21.6: Biosynthesis of methionine from homoserine, as it occurs in plants and bacteria.

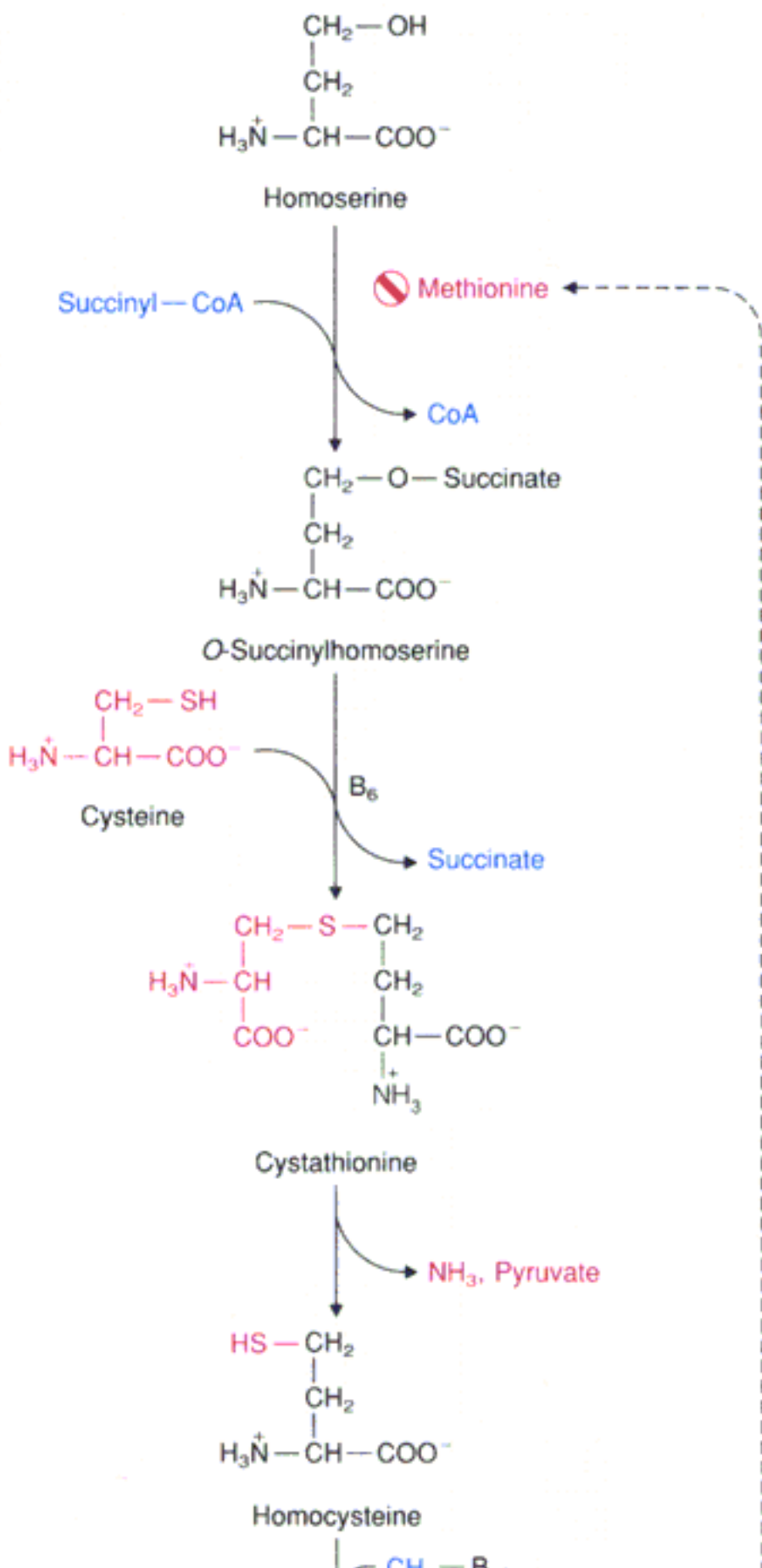

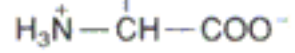

Homocysteine

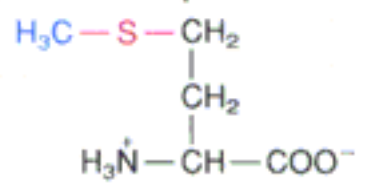
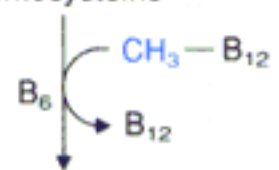

Methionine

Aspartokinase

Aspartokinase is an enzyme of amino acid biosynthesis that catalyzes the reaction below:



Aspartokinase is a major point of regulation of the biosynthetic pathways leading to [threonine](#), [lysine](#), and [methionine](#). In bacteria, there are three isoenzymes of **aspartokinase**. Activity of one form is inhibited specifically by threonine and that of another form by lysine. Synthesis of the third form is inhibited by methionine.

See also: [Citric Acid Cycle Intermediates in Amino Acid Metabolism](#), [Metabolism of Serine, Glycine, and Threonine](#), [Metabolism of Valine, Leucine, Isoleucine, and Lysine](#), [Metabolism of Sulfur-Containing Amino Acids](#)

Citric Acid Cycle Intermediates in Amino Acid Metabolism

About half of the 20 amino acids found in proteins are biosynthesized from intermediates in the [citric acid cycle](#) or from pyruvate ([Figure 20.12](#) and [Figure 21.1](#)). This includes [glutamate](#), [aspartate](#), and [alanine](#), which can be formed by transamination from α -[ketoglutarate](#), [oxaloacetate](#), and [pyruvate](#), respectively. It also includes [glutamine](#) and [asparagine](#), which are formed directly from glutamate and aspartate, respectively; and [proline](#) and [arginine](#), which are formed in short pathways from glutamate. Finally, [threonine](#), [methionine](#), and [isoleucine](#)-are derived from aspartate, but will be dealt with separately.

The illustrations [here](#) and [here](#) show the transamination reactions interconverting α -ketoglutarate, glutamate, and glutamine (see [here](#)) and oxaloacetate, aspartate, and asparagine (see [here](#)). Notice in each case that one enzyme is primarily involved in the anabolic reactions (making an amino acid) whereas a different enzyme is involved in the catabolic pathway (breaking down an amino acid).

To summarize:

- Transamination of [pyruvate](#) yields [alanine](#);
- Transamination of [oxaloacetate](#) yields [aspartate](#);
- Transamination of [aspartate](#) yields [asparagine](#);
- Transamination of α -[ketoglutarate](#) yields [glutamate](#);
- Transamination of [glutamate](#) yields [glutamine](#)

Glutamate has many fates and is discussed further in the first hyperlink below.

Aspartate has many fates, too. For example, its nitrogen is used in the biosynthesis of arginine and [urea](#). Similar reactions are involved in purine nucleotide synthesis. The entire aspartate molecule is used in pyrimidine nucleotide biosynthesis. In plants and bacteria, aspartate is a precursor to three other amino acids (i.e., methionine, threonine, and isoleucine) via its conversion to [homoserine](#) (see [here](#)). Homoserine then leads in separate pathways to methionine and threonine. Threonine, in turn, can be converted to isoleucine. In bacteria, [aspartic \$\beta\$ -semialdehyde](#) is a precursor to [lysine](#).

When bacteria reach a high enough cell density, N-acylhomoserine is synthesized and secreted at a low rate and it diffuses back into cells. There it binds to gene regulatory proteins, which, in turn, stimulate transcription of genes required to activate the phenomenon known as "quorum-sensing." This physiological response varies and can include luminescence, antibiotic synthesis, and conjugal gene transfer.

See also: [Glutamate as a Precursor to Other Amino Acids](#), [Transamination in Amino Acid Metabolism](#) (from Chapter 20), [De Novo Pyrimidine Nucleotide Metabolism](#) (from Chapter 22), [De Novo Biosynthesis of Purine Nucleotides](#) (from Chapter 22), [Glutaminase](#)

Cis-Aconitate

Cis-aconitate is an intermediate in synthesis of [isocitrate](#) from [citrate](#) in the [citric acid cycle](#). The enzyme catalyzing the reaction is [aconitase](#).

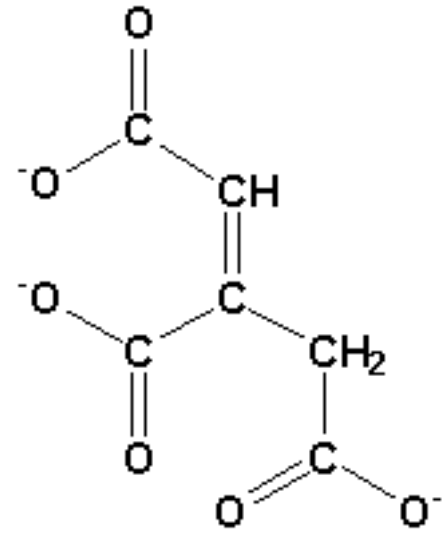

Cis-aconitate

Cis-aconitate is transiently formed as a product bound to the enzyme. The compound is formed from citrate by removal of a water, which is added back to obtain isocitrate ([reaction diagram](#)).

See also: [Intermediates of the Citric Acid Cycle](#), [Figure 14.3](#), [Table 14.1](#), [Fluoroacetate](#), [Fluorocitrate](#)

INTERNET LINKS:

1. [Glyoxylate Cycle Metabolism](#)
 2. [Citric Acid Cycle](#)
-

Figure 14.3: The fate of carbon in the citric acid cycle.

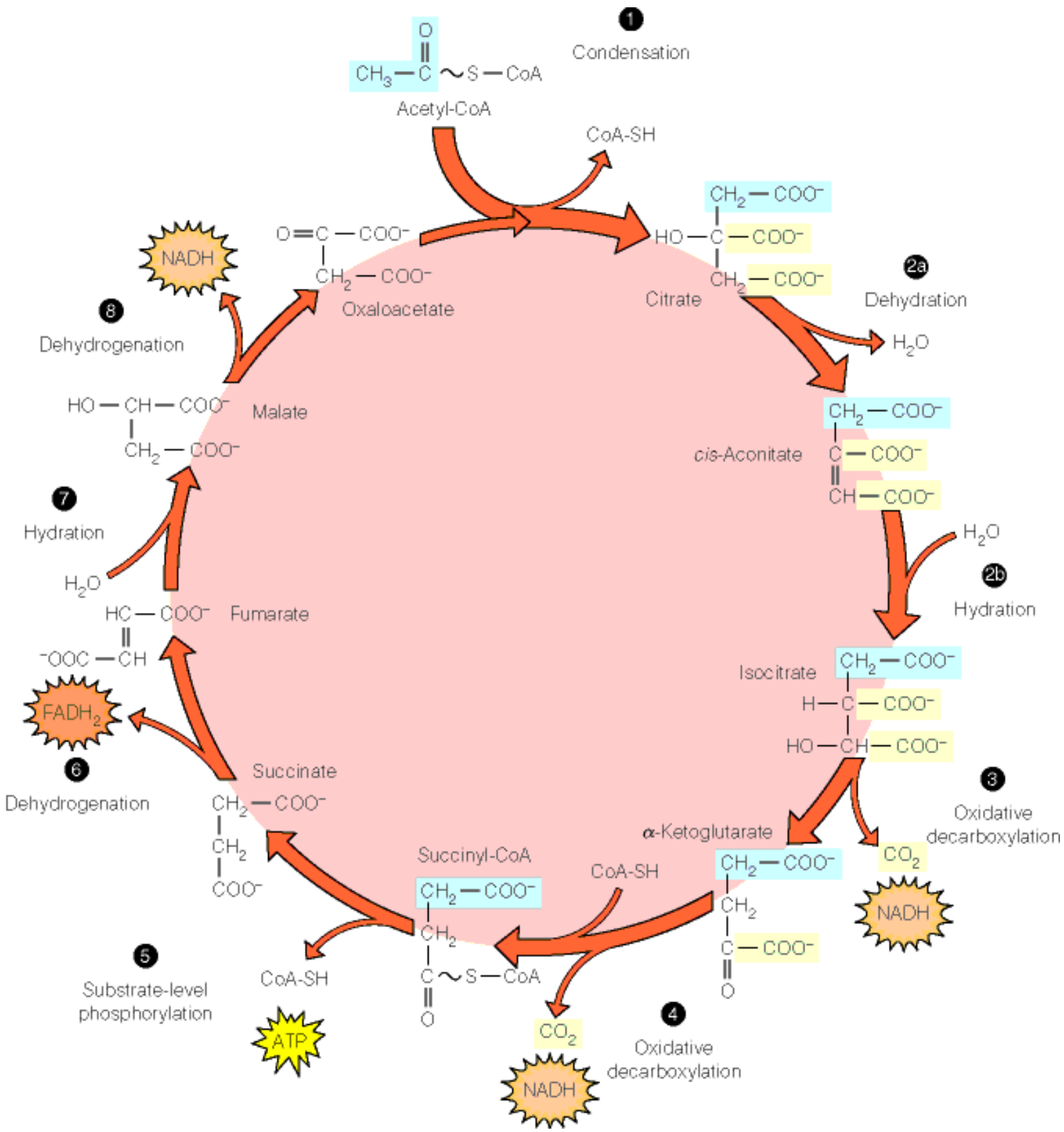

Table 14.1



Reaction	Enzyme	$\Delta G^{\circ'}$ (kJ/mol)
1. Acetyl-CoA + oxaloacetate + H ₂ O \longrightarrow citrate + CoA-SH + H ⁺	Citrate synthase	-32.2
2a. Citrate \rightleftharpoons <i>cis</i> -aconitate + H ₂ O	Aconitase	+6.3
2b. <i>cis</i> -Aconitate + H ₂ O \rightleftharpoons isocitrate	Aconitase	
3. Isocitrate + NAD ⁺ \rightleftharpoons α -ketoglutarate + CO ₂ + NADH	Isocitrate dehydrogenase	-20.9
4. α -Ketoglutarate + NAD ⁺ + CoA-SH \rightleftharpoons succinyl-CoA + CO ₂ + NADH	α -Ketoglutarate dehydrogenase complex	-33.5
5. Succinyl-CoA + P _i + GDP \rightleftharpoons succinate + GTP + CoA-SH	Succinyl-CoA synthetase	-2.9
6. Succinate + FAD (enzyme-bound) \rightleftharpoons fumarate + FADH ₂ (enzyme-bound)	Succinate dehydrogenase	0
7. Fumarate + H ₂ O \rightleftharpoons L-malate	Fumarase	-3.8
8. L-Malate + NAD ⁺ \rightleftharpoons oxaloacetate + NADH + H ⁺	Malate dehydrogenase	+29.7
	Net	-57.3

Fumarate

Fumarate is an intermediate of the [citric acid cycle](#) and the [glyoxylate cycle](#). produced by action of the enzyme succinate dehydrogenase on succinate. FADH₂ is produced from FAD in the reaction. **Fumarate** is converted to L-malate by addition of water to the molecule catalyzed by the enzyme fumarate hydratase.

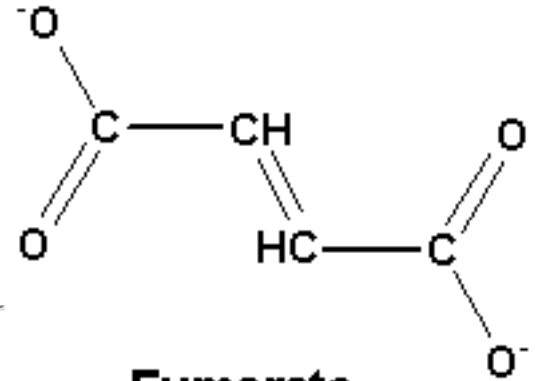

Fumarate

See also: [Enzymes](#) of the Citric Acid Cycle, [Intermediates](#) of the citric acid cycle, [Pathway](#) of the citric acid cycle, [Table 4.1](#), [Succinate Dehydrogenase](#), [Fumarate Hydratase](#)

INTERNET LINKS:

1. [Glyoxylate Cycle Metabolism](#)
 2. [Citric Acid Cycle](#)
 3. [Urea Cycle and Metabolism of Amino Groups](#)
-

Enzymes of the Citric Acid Cycle

Citrate Synthase

Aconitase

Isocitrate Dehydrogenase

⊗ Ketoglutarate Dehydrogenase Complex

Succinyl-CoA Synthetase

Succinate Dehydrogenase

Fumarate Hydratase

Malate Dehydrogenase

See also: Citric Acid Cycle, Citric Acid Cycle Intermediates, Figure 14.3, Table 14.1

INTERNET LINK: Citric Acid Cycle

Isocitrate Dehydrogenase

Isocitrate dehydrogenase is an enzyme of the [citric acid cycle](#) that catalyzes the reaction below ([reaction diagram](#))



An NADP⁺ specific form of the enzyme is present in both cytosol and mitochondria.

Isocitrate dehydrogenase is an allosteric control point in the citric acid cycle. In many cells, **isocitrate dehydrogenase** is activated by ADP and inhibited by NADH.

[Next](#) enzyme of citric acid cycle / [Previous](#) enzyme of citric acid cycle

See also: [Citric Acid Cycle Enzymes](#), [Figure 14.3](#), [Table 14.1](#)

INTERNET LINK: [Citric Acid Cycle](#)

Unnumbered Item

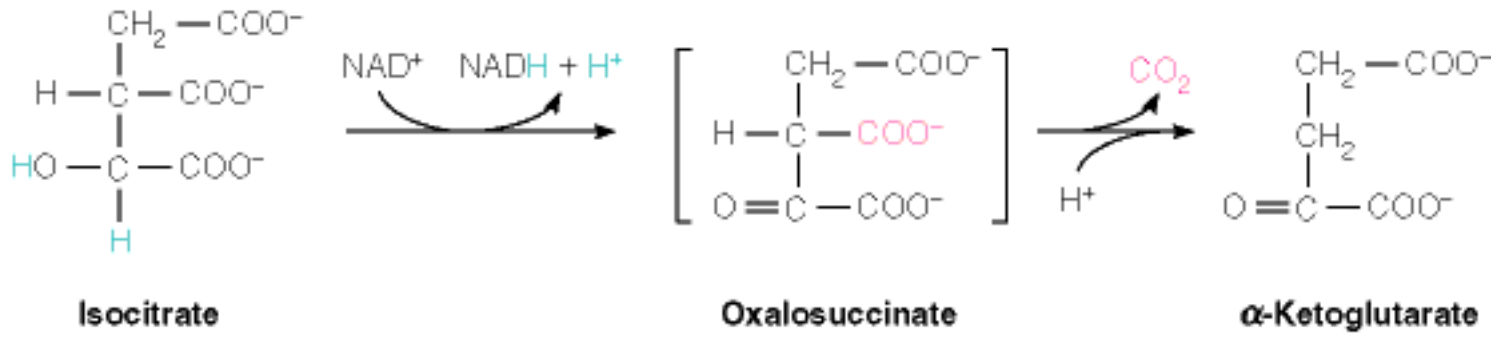

Fumarate Hydratase (Fumarase)

Fumarase is an enzyme of the [citric acid cycle](#), [glyoxylate cycle](#), and [urea cycle](#) that catalyzes addition of water to the double bond of fumarate to form L-malate.



The enzyme is stereospecific, working only on the *trans* isomer.

[Next](#) enzyme of citric acid cycle / [Previous](#) enzyme of cycle

See also: [Enzymes](#) of the citric acid cycle, [Intermediates](#) of the Citric Acid Cycle, [Pathway](#) of the Citric Acid Cycle, [Table 14.1](#)

INTERNET LINKS:

1. [Glyoxylate Cycle Metabolism](#)
 2. [Citric Acid Cycle](#)
 3. [Urea Cycle and Metabolism of Amino Groups](#)
-

Urea

Ammonia is a universal participant in amino acid synthesis and degradation, but its accumulation has toxic consequences. Because terrestrial animals must conserve water, they convert ammonia to a form that can be excreted without large water losses. Birds, terrestrial reptiles, and insects convert most of their excess ammonia to **uric acid**, an oxidized purine. Most mammals excrete the bulk of their nitrogen as **urea**.

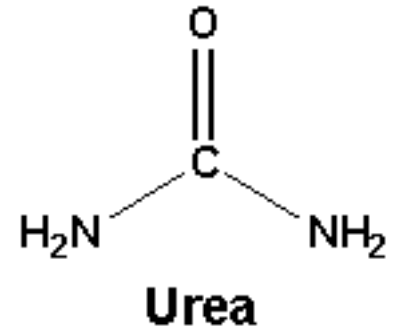

Urea is synthesized almost exclusively in the liver and then transported to the kidneys for excretion. The process that generates urea is called the urea cycle and is depicted in **Figure 20.13**. **Urea** is synthesized almost exclusively in the liver and then transported to the kidneys for excretion. The enzyme **arginase** is responsible for the cyclic nature of the **urea** cycle and for production of urea, as follows:

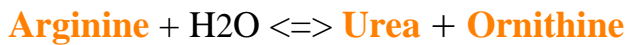

Virtually all organisms synthesize arginine from ornithine by the reactions shown in **Figure 20.13**. However, only ureotelic organisms (those excreting most of their nitrogen as urea) contain arginase and, hence, only those organisms carry out the cyclic pathway.

See also: [Urea Cycle Descriptions](#), [Urea Cycle Reactions](#), [Utilization of Ammonia](#), [Uric Acid](#), [Purine Degradation](#)

INTERNET LINK: [Urea Cycle and Metabolism of Amino Groups](#)

Arginase

Arginase is an enzyme of the urea cycle that catalyzes the following reaction:

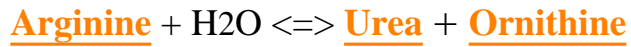

Virtually all organisms use the reactions shown in [Figure 20.13](#) to synthesize arginine from ornithine, but they lack the **arginase** enzyme needed to complete the urea cycle and thus make urea. Only ureotelic organisms—those that excrete urea—contain **arginase**, so only ureotelic organisms can carry out the cyclic urea cycle pathway.

See also: [Urea Cycle Descriptions](#), [Urea Cycle Reactions](#)

INTERNET LINK: [Urea Cycle and Metabolism of Amino Groups](#)

L-Ornithine

L-Ornithine is an intermediate in the [urea cycle](#) that is formed by action of the enzyme [arginase](#) on arginine.

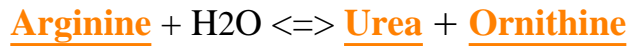

Ornithine is also combined with carbamoyl phosphate by action of the enzyme [ornithine transcarbamoylase](#) to form citrulline

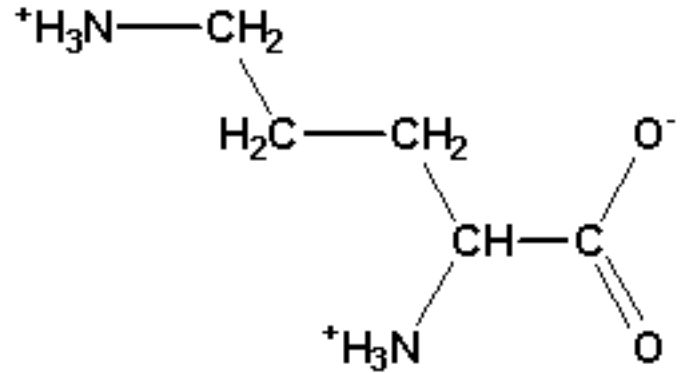

L-Ornithine

See also: [Amino Acids Not In Proteins](#), , [Arginine](#), [Urea](#), [Citrulline](#), [Metabolism of Ornithine and Arginine](#)

INTERNET LINKS:

1. [Ornithine Metabolism](#)
 2. [Urea Cycle and Metabolism of Amino Groups](#)
-

Ornithine Transcarbamoylase

Ornithine transcarbamoylase is an enzyme of the urea cycle that catalyzes the following reaction:



The reaction takes place in the mitochondria.

See also: [Urea Cycle Descriptions](#), [Urea Cycle Reactions](#), [Utilization of Ammonia](#)

INTERNET LINK: [Urea Cycle and Metabolism of Amino Groups](#)

Citrulline

Citrulline is an intermediate in the [urea cycle](#).

Reaction 1 below occurs in the mitochondrion, but reaction 2 occurs in the cytoplasm.

1. [Carbamoyl Phosphate](#) + [Ornithine](#) \rightleftharpoons

[Citrulline](#) + Pi (catalyzed by [Ornithine](#)

[Transcarbamoylase](#))

2. [Citrulline](#) + [ATP](#) + [Aspartate](#) \rightleftharpoons

[Argininosuccinate](#) + [AMP](#) + PPi (catalyzed by

[Argininosuccinate Synthetase](#))

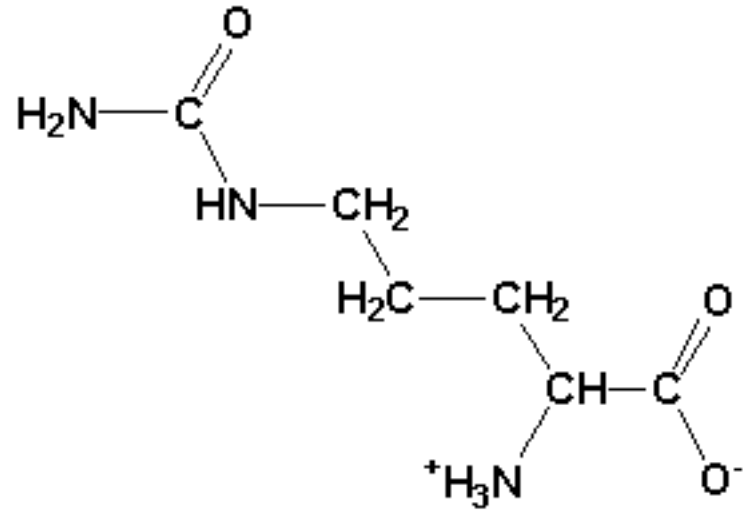

Citrulline

See also: [Urea Cycle](#), [Amino Acids Not In Proteins](#), [Ornithine](#), [Aspartate](#)

INTERNET LINK: [Urea Cycle and Metabolism of Amino Groups](#)

Argininosuccinate

Argininosuccinate is an intermediate in the urea cycle. It participates in the reactions below.

1. **Citrulline** + **ATP** + **Aspartate** \rightleftharpoons **Argininosuccinate** + **AMP** + PPi
(catalyzed by **Argininosuccinate Synthetase**)

2. **Argininosuccinate** \rightleftharpoons **Arginine** + **Fumarate** (catalyzed by **Argininosuccinase**).

See also: [Urea Cycle Description](#), [Urea Cycle Reactions](#), [Figure 20.13](#)

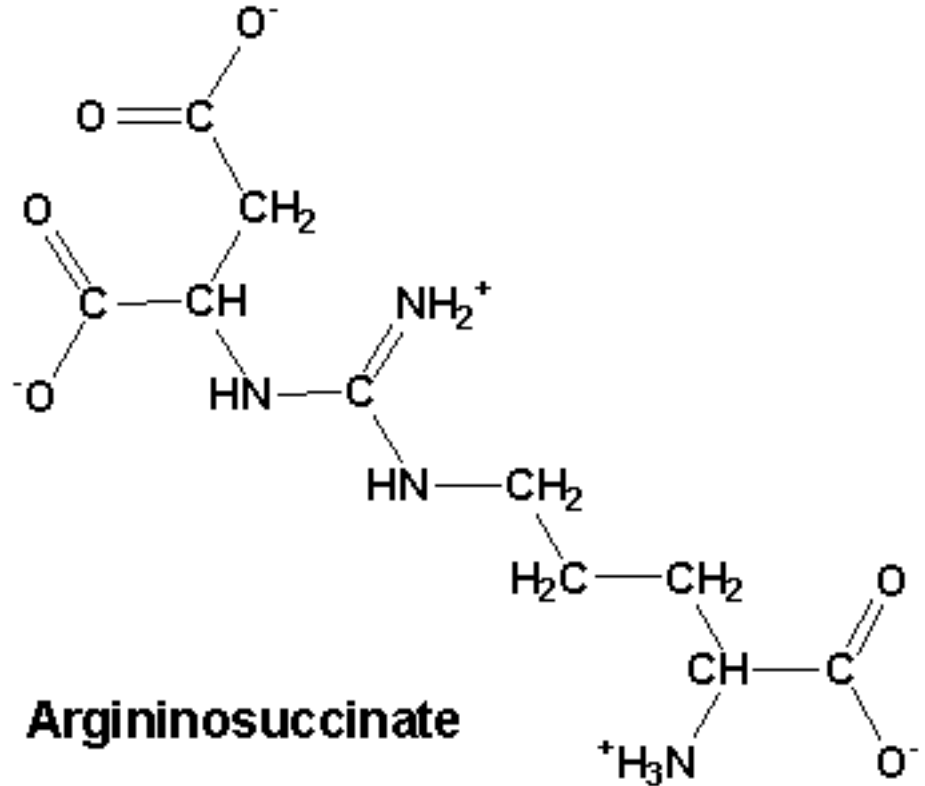

INTERNET LINK: [Urea Cycle and Metabolism of Amino Groups](#)

Argininosuccinate Synthetase

Argininosuccinate synthetase is an enzyme of the urea cycle that catalyzes the following reaction:

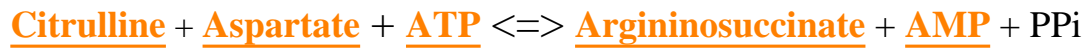

See also: [Urea Cycle Description](#), [Urea Cycle Reactions](#), [Figure 20.13](#)

INTERNET LINK: [Urea Cycle and Metabolism of Amino Groups](#)

L-Malic Acid (Malate)

L-malate is an intermediate in the [citric acid cycle](#), [urea cycle](#), amino acid metabolism, the [glyoxylate cycle](#), and shuttles across membranes of the cell ([Figure 18.31](#)).

In the citric acid cycle (and urea cycle), **L-malate** is produced by addition of water to the molecule fumarate catalyzed by the enzyme [fumarate hydratase](#). D-Malate cannot be produced by the enzyme.

L-malate is converted to oxaloacetate by action of the enzyme [malate dehydrogenase](#). NADH is another product of this reaction. The same reactions occur in the urea cycle as well.

In the glyoxylate cycle, **L-malate** is created by combining glyoxylate with acetyl-CoA in a reaction catalyzed by the enzyme [malate synthase](#).

[Malic enzyme](#) provides yet another way to make **L-malate**.

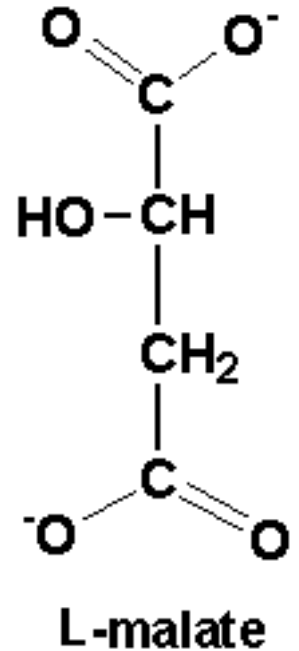

See also: [Oxaloacetate](#), [Fumarate](#), [Citrate Shuttle](#), [Shuttling Electron Carriers into the Mitochondrion](#), [Figure 15.11](#)

INTERNET LINKS:

1. [Glyoxylate Cycle Metabolism](#)
 2. [Citric Acid Cycle](#)
 3. [Urea cycle and Metabolism of Amino Groups](#)
-

Figure 18.31: Transport of acetyl units and reducing equivalents used in fatty acid synthesis.

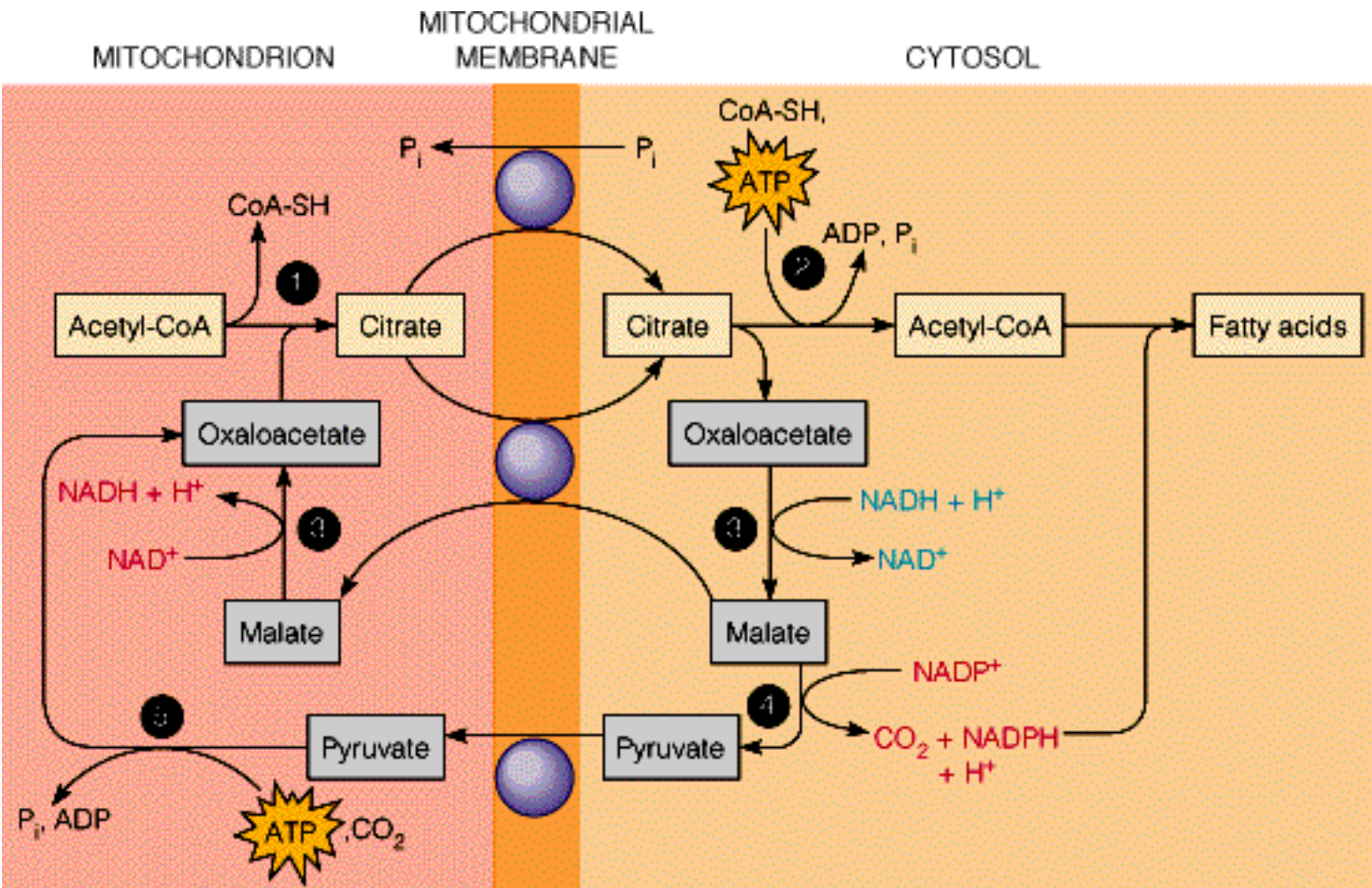

Malate Dehydrogenase

Malate dehydrogenase is an enzyme of the [citric acid cycle](#), [urea cycle](#), and [glyoxylate cycle](#) catalyzing the reaction below:



This highly endergonic reaction proceeds to produce oxaloacetate because the highly exergonic [citrate synthase](#) reaction keeps intramitochondrial oxaloacetate levels exceedingly low (below 1 μ M).

Plants have one form of the enzyme in glyoxysomes and another in mitochondria.

[Next](#) enzyme of citric acid cycle / [Previous](#) enzyme of cycle

See also: [Citric Acid Cycle](#), [Glyoxylate Cycle](#), [Citric Acid Cycle Enzymes](#), [Citric Acid Cycle Intermediates](#), [Figure 14.3](#), [Table 14.1](#), [Citrate Shuttle](#)

INTERNET LINKS:

1. [Glyoxylate Cycle Metabolism](#)
 2. [Citric Acid Cycle](#)
 3. [Urea Cycle and Metabolism of Amino Groups](#)
-

Citrate Shuttle

When acetyl-CoA accumulates in the mitochondrial matrix (for example, after a big meal), it must be moved to the cytoplasm where it can be used in fatty acid biosynthesis. Acetyl-CoA cannot pass directly through the inner membrane of the mitochondrion, however, and must be shuttled out of the mitochondrion on the back of oxaloacetate (to form citrate). The citrate shuttle system operates as follows (see [Figure 18.31](#)):

1. [Acetyl-CoA](#) + [Oxaloacetate](#) \rightarrow [Citrate](#) + [CoASH](#) (catalyzed by [Citrate Synthase](#))
2. [Citrate](#) is transported across the mitochondrial membrane
3. In the cytoplasm, citrate is converted back to oxaloacetate and acetyl-CoA (Catalyzed by [citrate lyase](#), [Figure 18.31](#)).
4. To move the oxaloacetate (released after the last step) back into the mitochondrion, [Oxaloacetate](#) + [NADH](#) + H^+ \rightarrow [L-Malate](#) + [NAD](#)⁺ (catalyzed by [Malate Dehydrogenase](#))
5. [L-Malate](#) + [NADP](#)⁺ \rightarrow [NADPH](#) + [Pyruvate](#) + H^+ (catalyzed by [Malic Enzyme](#))
6. [Pyruvate](#) is transported into the mitochondrial matrix.
7. Inside the mitochondrial matrix, [Pyruvate](#) + ATP + CO₂ \rightarrow [Oxaloacetate](#) + ADP + Pi (catalyzed by [Pyruvate Carboxylase](#)).

The net effect of these reactions is that acetyl-CoA is moved out of the mitochondrion and cytosolic NADH is converted to cytosolic NADPH. NADPH is used, in turn, for the biosynthesis of fatty acids. Recall (see [here](#)) that the synthesis of 1 mole of palmitate requires 14 moles of NADPH, most of which is generated in the cytosol via the pentose phosphate pathway.

See also: [Fatty Acid Biosynthesis Strategy](#), [\$\beta\$ -Oxidation](#), [Pentose Phosphate Pathway](#)

Citrate Lyase

Citrate lyase is a cytoplasmic enzyme that is important in the citrate shuttle, which moves excess acetyl-CoA from the mitochondrion to the cytoplasm. **Citrate lyase** catalyzes the reaction below:



See also: [Citrate Shuttle](#)

Malic Enzyme

Malic Enzyme (officially named **malate dehydrogenase-decarboxylating: NADP⁺**) catalyzes the reaction below.

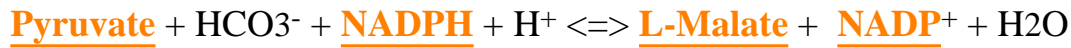

This important anaplerotic reaction provides a means of replenishing L-malate in the citric acid cycle ([Figure 14.18](#)) and it also plays an important role in the citrate shuttle ([Figure 18.31](#)).

See also: [Citric Acid Cycle](#), [Anaplerotic Reaction](#), [Citrate Shuttle](#)

Figure 14.18: Major biosynthetic roles of some citric acid cycle intermediates.

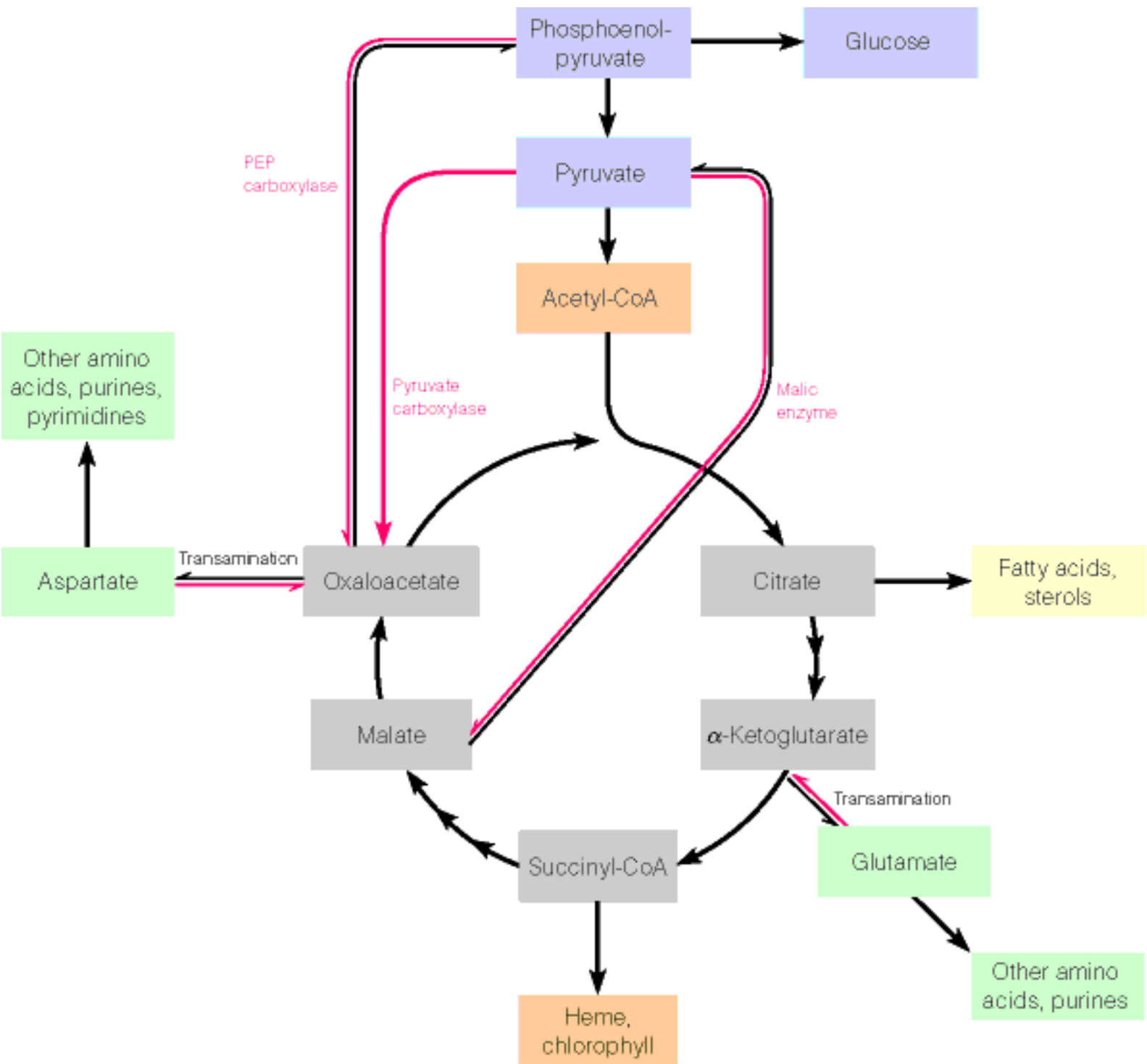
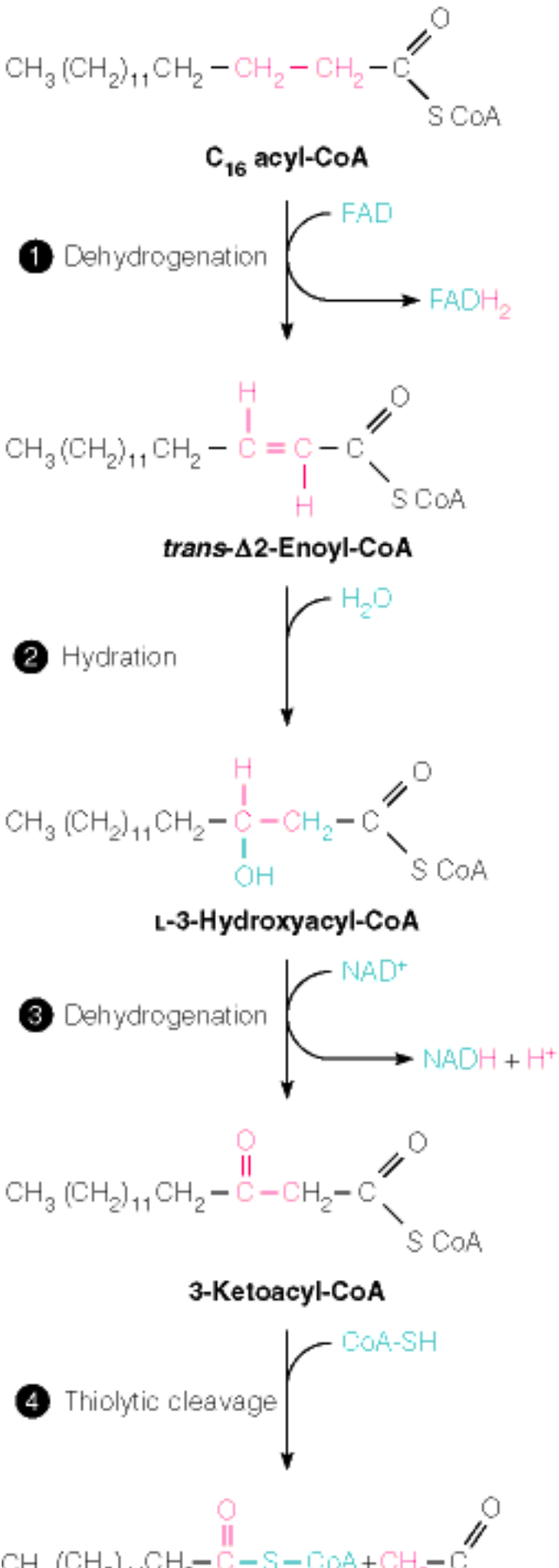
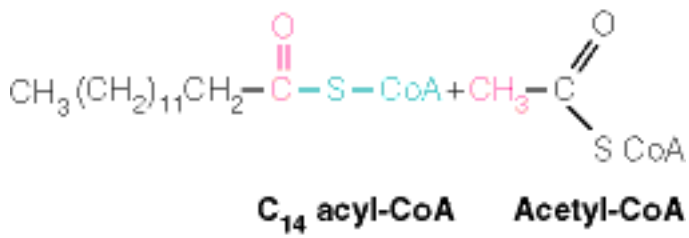
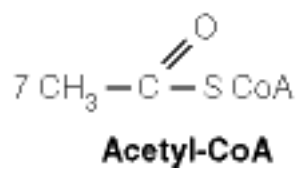

Figure 18.16: Outline of the β -oxidation of fatty acids.





6 additional cycles
of reactions 1-4



Triacylglycerol Synthesis

Fatty acyl-CoAs and **glycerol-3-phosphate** are the primary precursors to **triacylglycerols**. Glycerol-3-phosphate can be made by

1. Reduction of **dihydroxyacetone phosphate** (catalyzed in adipocytes by **glycerol phosphate dehydrogenase**)
2. ATP-dependent phosphorylation of glycerol by **glycerol kinase**

Adipocytes do not contain glycerol kinase and thus cannot rebuild a fat from glycerol generated by hydrolysis of another fat.

Glycerol-3-phosphate is joined to two fatty acyl groups to form diacylglycerol-3-phosphate, also known as **phosphatidic acid**, which is a precursor to phospholipids and triacylglycerols. Conversion to **triacylglycerols** involves hydrolysis of the phosphate group to form diacylglycerol followed by addition of a third acyl group from a fatty acyl-CoA.

See also: **Triacylglycerols**

Glycerol-3-Phosphate (Gly3P)

Gly3P is readily formed from glycerol by ATP-dependent phosphorylation catalyzed by [glycerol kinase](#), is an important part of glycerol metabolism. Glycerol is generated by digestion of fats. **Gly3P** plays important roles in two metabolic processes:

1. Conversion of **Gly3P** to **DHAP** by the enzyme [glycerol-3-phosphate dehydrogenase](#) adds [glycerol's](#) carbon backbone to the [glycolysis](#) or [gluconeogenesis](#) pathways.
2. **Gly3P** is a precursor to triacylglycerols (fats) (see [here](#)).

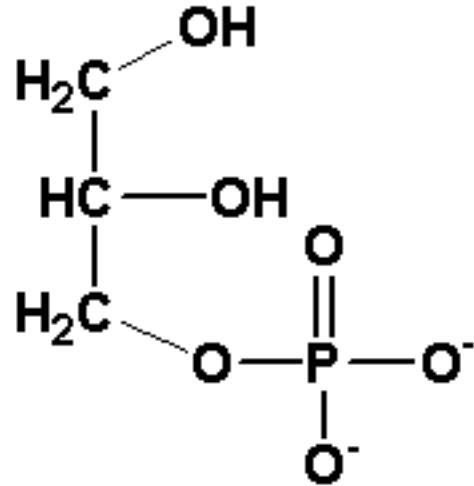

Glycerol-3-phosphate (Gly3P)

See also: [Triacylglycerol Synthesis, Figure 19.2](#)

Glycerol Kinase

Glycerol Kinase is an enzyme in the liver that is important in glycerol metabolism.

It catalyzes the reaction below:



Glycerol-3-phosphate, thus formed, can be oxidized to dihydroxyacetone phosphate by the enzyme glycerol-3-phosphate dehydrogenase.

See also: [Glycerol Metabolism](#), [Dihydroxyacetone Phosphate](#), [Glycerol-3-Phosphate Dehydrogenase](#)

Glycerol

Glycerol forms the backbone for the fats/oils ([tricylglycerols](#)), the [glycerophospholipids](#), [diacylglycerols](#), and the [monoacylglycerol](#). Free **glycerol** is produced metabolically by digestion of a fat or phospholipids. It can enter the glycolytic pathway via phosphorylation (requires [ATP](#)) in the liver by the enzyme [glycerol kinase](#) to form [glycerol-3-phosphate](#), which is then oxidized to [dihydroxyacetone phosphate](#). Dihydroxyacetone phosphate is, of course an intermediate in other pathways, such as [glycolysis](#), [gluconeogenesis](#), and in phospholipid synthesis.

Free **glycerol** is also produced in synthesis of [cardiolipin](#) from [phosphatidylglycerol](#) ([Figure 19.4](#))

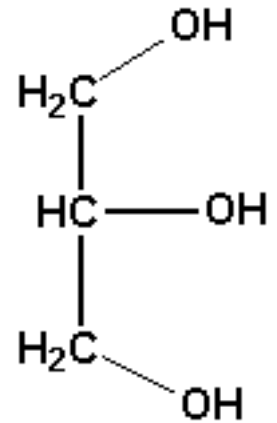

Glycerol

See also: [Fat](#), [Glycerol Kinase](#), [Glycolysis](#), [Gluconeogenesis](#), [Glycerol Metabolism](#), [Gluconeogenesis Precursors](#), [Figure 12.2](#)

Fats (Triacylglycerols)

Fats are composed of **glycerol** esterified to three **fatty acids**. **Fats** are derived from three primary sources: (1) the diet; (2) *de novo* biosynthesis, particularly in liver; and (3) storage depots in adipocytes. Processes by which these sources are utilized in animals are summarized in **Figure 18.3**. Breakdown of **fats** by lipases yields fatty acids and glycerol.

See also: [Adipocytes](#), [Fat Absorption and Transport](#), [Bile Salts and Emulsion of Fats](#), [Mobilization of Stored Fat](#), [Energy Storage](#), [Triacylglycerol Synthesis](#), [Action of Insulin](#), [Lipids](#)

Figure 18.3: Overview of fat digestion, absorption, storage, and mobilization in the human.

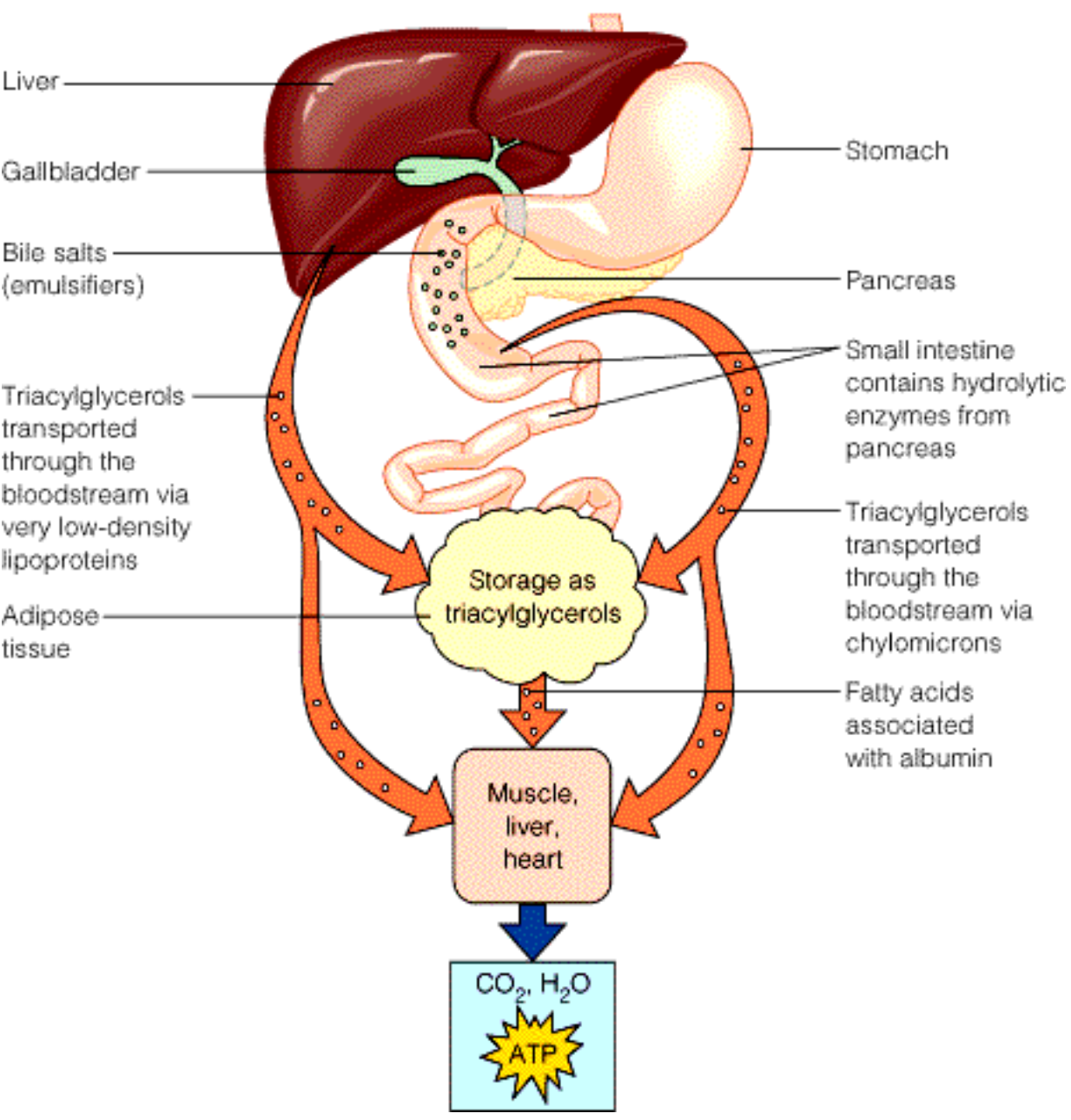

Adipocytes



Adipocytes are cells of the body involved in storage of fat.

See also: [Energy Storage](#), [Triacylglycerol Synthesis](#), [Biochemistry of Obesity](#), [Lipids](#)

Fats and Energy Storage

Fats are the primary **energy storage** form in animals and in plant seeds because energy can be stored more densely in **fats** than in carbohydrates. That is, metabolic oxidation of fats yields 37 J/g, whereas carbohydrates and proteins yield only 17 kJ/g.

A typical 70-kg human may have the following fuel reserves:

400,000 kJ in total human body **fat** energy

100,000 kJ in total human protein energy

2500 kJ in total human glycogen energy

170 kJ in total human glucose energy

Brain cannot use **fats** for energy; instead, brain has a specific requirement for glucose. Under conditions of starvation, however, when blood glucose levels decrease, brain can adjust to use ketone bodies, which can be derived from fatty acids.

See also: Fat, Glucose, Glycogen, , Fat Absorption and Transport

Ketone Bodies

Ketone bodies are produced by the process of ketogenesis, which occurs when acetyl-CoA accumulates beyond its capacity to be oxidized or used for fatty acid synthesis. Under these conditions, the thiolase-catalyzed reaction favors production of acetoacetyl-CoA ([Figure 18.21](#)), which is ultimately converted to the **ketone bodies** - acetoacetate, acetone, and β -hydroxybutyrate.

See also: [Ketogenesis](#), [Thiolase](#), [Acetoacetate](#), [Acetone](#), [\$\beta\$ -Hydroxybutyrate](#), [Biological Fuel](#), [Brain Metabolism](#), [Liver Metabolism](#)

Figure 18.21: Biosynthesis of ketone bodies in the liver.

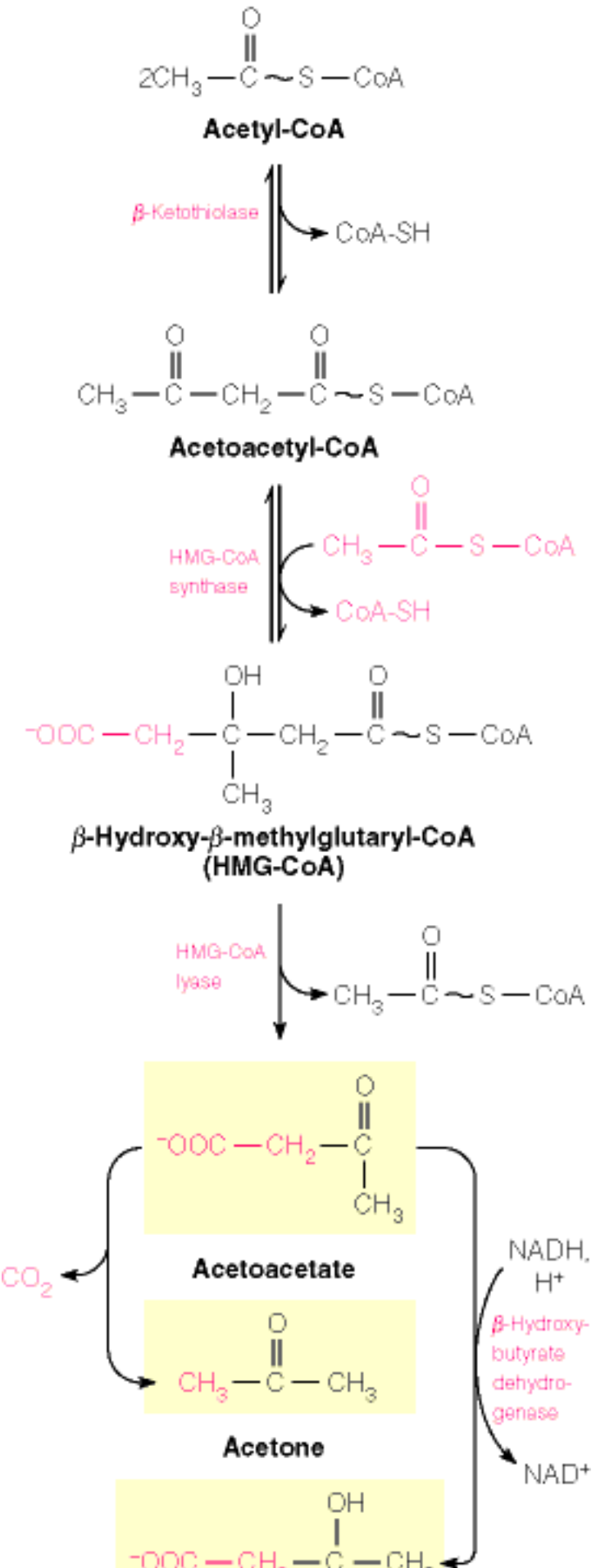

Acetone

NAD⁺

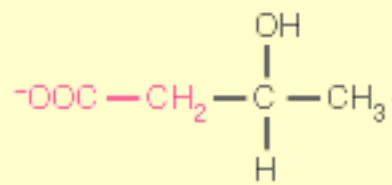

β -Hydroxybutyrate

Ketogenesis

Under conditions where acetyl-CoA concentration is high, the thiolase reaction can be reversed to yield acetoacetyl-CoA (Figure 18.21) in the following reaction:



Addition of another acetyl-CoA to acetoacetyl-CoA yields β -hydroxy- β -methylglutaryl-CoA (also called HMG-CoA):



This reaction is catalyzed by HMG-CoA synthase.

In the cytosol, HMG-CoA is an early intermediate in cholesterol biosynthesis. In the mitochondria, however, HMG-CoA lyase acts on HMG-CoA to yield acetoacetate plus acetyl-CoA, as follows:



Acetoacetate can be reduced to form β -hydroxybutyrate by action of the enzyme β -hydroxybutyrate dehydrogenase, as shown below.

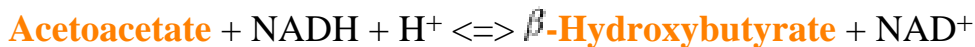

Acetoacetate and β -hydroxybutyrate are known as **ketone bodies** and are important in delivering energy to the brain when glucose is not available, such as during starvation.

Acetoacetate can also undergo spontaneous decarboxylation to form acetone.

The process of **ketogenesis** is also referred to as **ketosis**. One sign of **ketosis** is the odor of acetone on the breath. This may occur in some forms of diabetes.

See also: Ketone Bodies, Acetone, Response to Starvation (from Chapter 23)

β -Keto-Thiolase (Thiolase)

Thiolase is an enzyme of the fatty acid β oxidation cycle that adds a CoASH to β -keto-acyl-CoA to convert it to an acyl-CoA with two less carbons plus acetyl-CoA:



Thiolase is also important in formation of ketone bodies when the acetyl-CoA concentration is high.

See also: [\$\beta\$ Oxidation of Saturated Fatty Acids](#), [Unsaturated Fatty Acid Oxidation](#), [Oxidation of Odd-Numbered Fatty Acids](#), [Peroxisomal \$\beta\$ -Oxidation](#), [Fatty Acids](#), [Ketogenesis](#)

INTERNET LINK: [Fatty Acid Metabolism](#)

3-Ketoacyl-CoA

3-Ketoacyl-CoA is an intermediate in the β oxidation of fatty acids. It is the last acyl moiety made prior to cleavage of the acetyl group by thiolase. **3-Ketoacyl-CoA** is produced and used (respectively) in the reactions that follow ([Figure 18.16](#)):

1. [L-3-Hydroxyacyl-S-CoA](#) + [NAD⁺](#) \rightleftharpoons [3-Ketoacyl-S-CoA](#) + [NADH](#) + H⁺ (catalyzed by [3-Hydroxyacyl-CoA Dehydrogenase](#))
2. [3-Ketoacyl-CoA](#) + [CoASH](#) \rightleftharpoons [Acyl-CoA](#) (less 2 carbons) + [Acetyl-CoA](#) (catalyzed by [Thiolase](#)).

See also: [\$\beta\$ Oxidation of Saturated Fatty Acids](#), [Unsaturated Fatty Acid Oxidation](#), [Oxidation of Odd-Numbered Fatty Acids](#), [Peroxisomal \$\beta\$ -Oxidation](#), [Fatty Acids](#)

INTERNET LINK: [Fatty Acid Metabolism](#)

L-3-Hydroxyacyl-S-CoA

L-3-Hydroxyacyl-S-CoA is an intermediate in fatty acid oxidation ([Figure 18.16](#)) that participates in the reactions below:

1. **Trans- Δ^2 -Enoyl-S-CoA** + H₂O \rightleftharpoons **L-3-Hydroxyacyl-S-CoA** (catalyzed by **Enoyl-CoA Hydratase**)
2. **L-3-Hydroxyacyl-S-CoA** + **NAD⁺** \rightleftharpoons **3-Ketoacyl-S-CoA** + **NADH** + H⁺ (catalyzed by **3-Hydroxyacyl-CoA Dehydrogenase**)

See also: [\$\beta\$ -Oxidation of Saturated Fatty Acid](#), [Unsaturated Fatty Acid Oxidation](#), [Oxidation of Odd-Numbered Fatty Acids](#), [Peroxisomal \$\beta\$ -Oxidation](#), [Fatty Acids](#)

INTERNET LINK: [Fatty Acid Metabolism](#)

Trans- Δ^2 -Enoyl-ACP

Trans- Δ^2 -enoyl-ACP is an intermediate in fatty acid biosynthesis. It is formed in the reaction that follows,

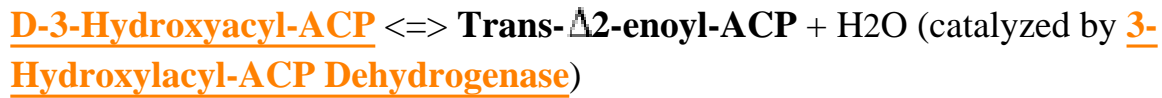

and is converted to acyl-ACP in the next reaction:

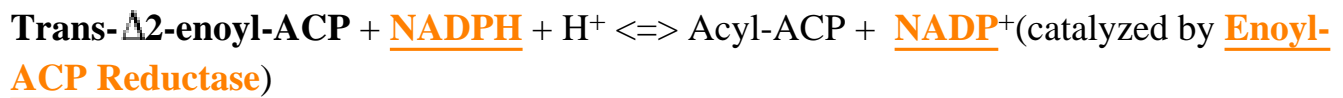

See also: [Fatty Acid Biosynthesis Strategy](#), [Fatty Acid Synthase](#), [Fatty Acids](#), [Palmitate Synthesis from Acetyl-CoA](#), [Synthesis of Long Chain Fatty Acids](#), [Figure 18.27](#)

D-3-Hydroxyacyl-ACP

D-3-Hydroxyacyl-ACP is an intermediate in fatty acid biosynthesis. It participates in the reactions as follows ([Figure 18.27](#)):

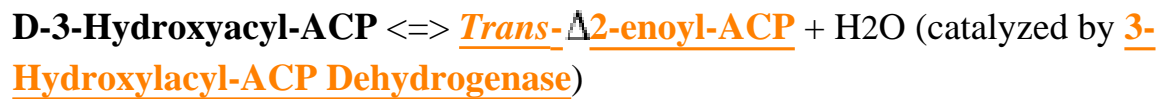
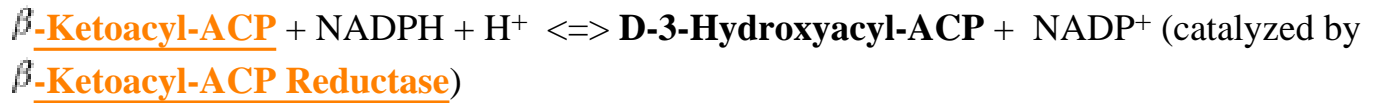

See also: [Fatty Acid Biosynthesis Strategy](#), [Fatty Acid Synthase](#), [Fatty Acids](#), [Palmitate Synthesis from Acetyl-CoA](#), [Synthesis of Long Chain Fatty Acids](#)

INTERNET LINK: [Fatty Acid Metabolism](#)

Figure 18.27: Synthesis of palmitate, starting with malonyl-ACP and acetyl-ACP.

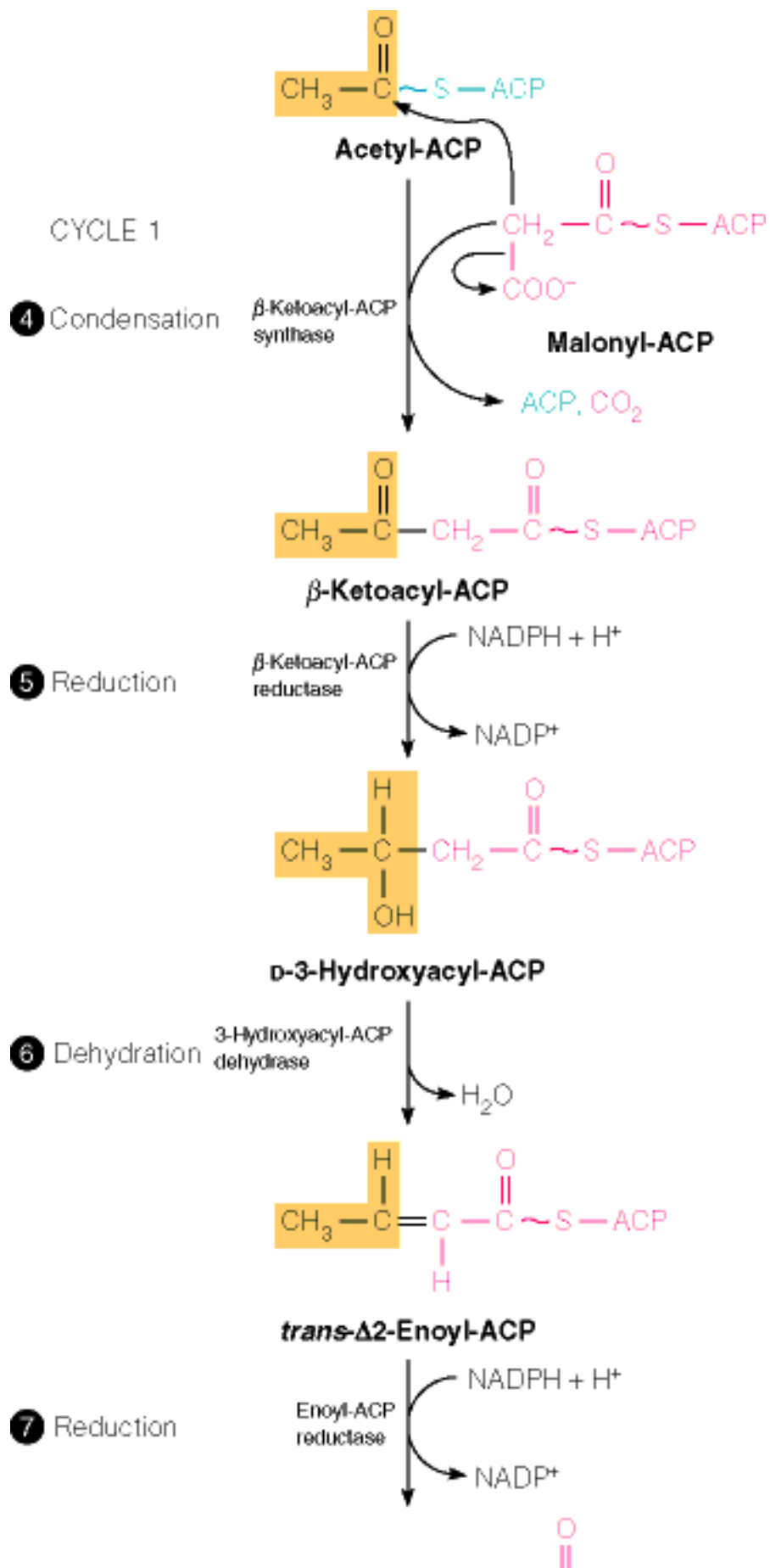

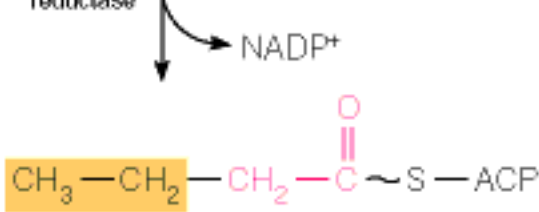

Butyryl-ACP

CYCLE 2

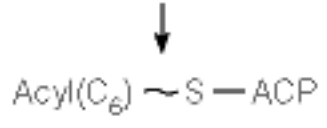

CYCLES 3-7

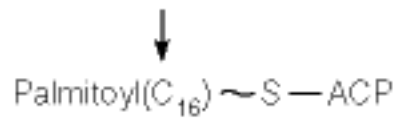

HYDROLYSIS

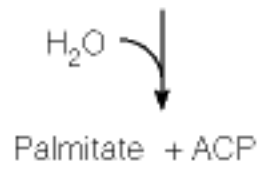

β -Ketoacyl-ACP

β -Ketoacyl-ACP is a metabolite in fatty acid biosynthesis. It participates in the reactions as follows ([Figure 18.27](#)):

1. [Acetyl-ACP](#) + [Malonyl-ACP](#) \rightleftharpoons [\$\beta\$ -Ketoacyl-ACP](#) + [ACP](#) + CO₂ (catalyzed by [\$\beta\$ -Ketoacyl-ACP Synthase](#))
2. [\$\beta\$ -Ketoacyl-ACP](#) + NADPH + H⁺ \rightleftharpoons [D-3-Hydroxyacyl-ACP](#) + NADP⁺ (catalyzed by [\$\beta\$ -Ketoacyl-ACP Reductase](#))

See also: [Fatty Acid Biosynthesis Strategy](#), [Fatty Acid Synthase](#), [Fatty Acids](#), [Palmitate Synthesis from Acetyl-CoA](#), [Synthesis of Long Chain Fatty Acids](#)

INTERNET LINK: [Fatty Acid Biosynthesis](#)

AMP-Dependent Protein Kinase



AMP-dependent protein kinase is an enzyme that binds AMP and can phosphorylate both acetyl-CoA carboxylase and HMG-CoA reductase kinase. In each case, the enzyme is inactivated.

See also: Acetyl-CoA Carboxylase, Control of Fatty Acid Synthesis

Control of Fatty Acid Synthesis

Fatty acid biosynthesis is **regulated** largely by hormonal mechanisms ([Figure 18.34](#)). [Acetyl-CoA carboxylase](#), the first enzyme in the pathway, is an important regulatory enzyme for the entire pathway. **Fatty acid biosynthesis** is inactivated in two ways through control of acetyl-CoA carboxylase activity:

1. Phosphorylation of acetyl-CoA carboxylase by the [cAMP-dependent protein kinase](#) (see [Figure 13.18](#)) tends to inactivate acetyl-CoA carboxylase by favoring depolymerization to the monomeric form.
2. Long chain fatty acyl-CoAs inactivate acetyl-CoA carboxylase.

Conversely, **fatty acid biosynthesis** can be activated by insulin as follows ([Figure 18.34](#)):

1. [Insulin](#) promotes entry of [glucose](#) into cells which, in turn, favors production of [NADPH](#) via entry of [glucose-6-phosphate](#) into the [pentose phosphate pathway](#).
2. Insulin activates the [pyruvate dehydrogenase complex](#), which promotes production of [acetyl-CoA](#).
3. Insulin reverses the effects of the kinase cascade, and stimulates dephosphorylation of acetyl-CoA carboxylase. This, in turn, promotes the conversion of the enzyme to its active, polymeric form.

In addition to hormonal/covalent regulation of acetyl-CoA carboxylase, allosteric interactions of the enzyme with [citrate](#) or acyl-CoAs favor polymerization or depolymerization, respectively, of the enzyme.

See also: [Kinase Cascade](#)

Figure 18.34: Regulation of fatty acid synthesis in animal cells, such as liver cells.

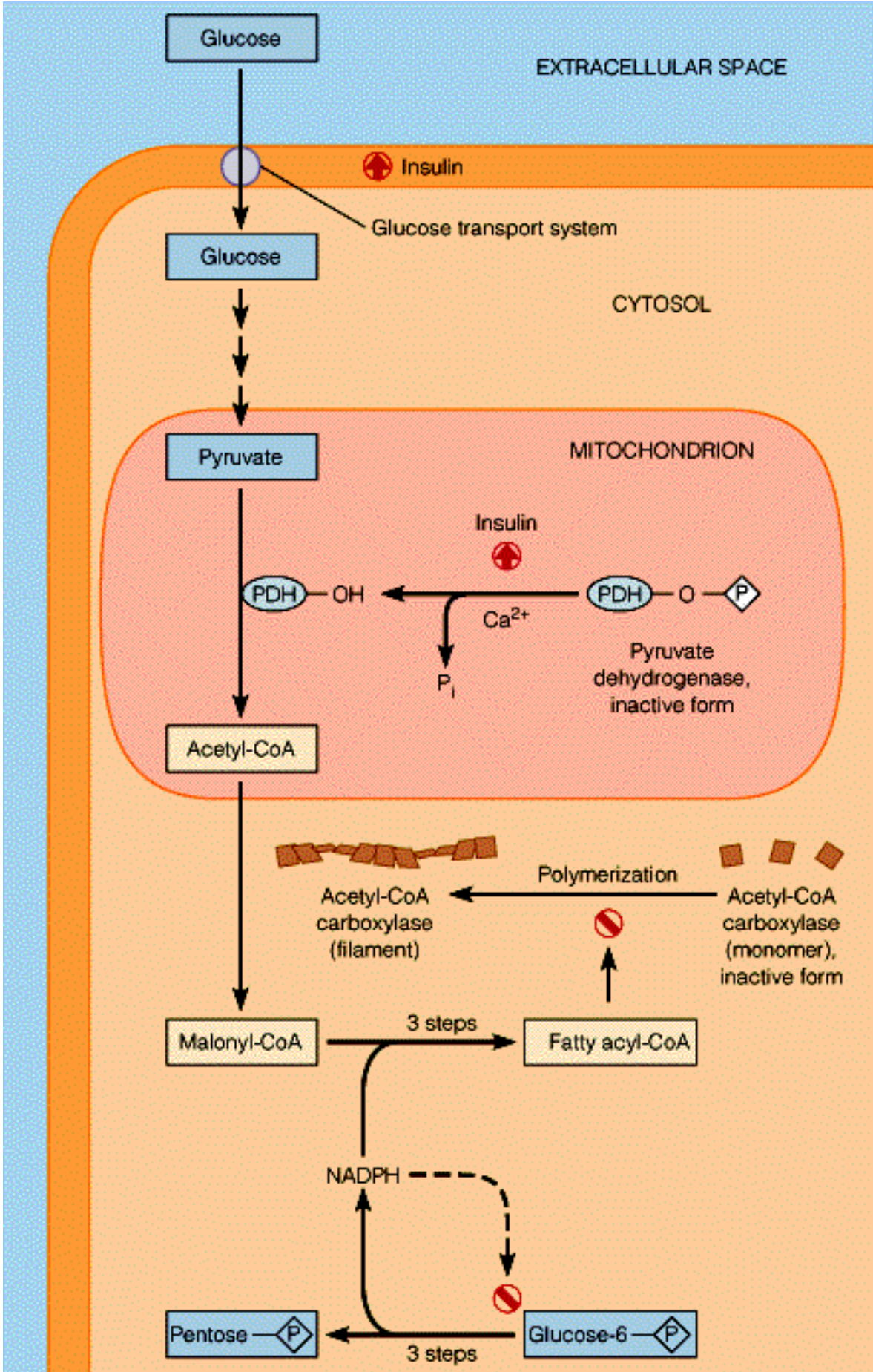

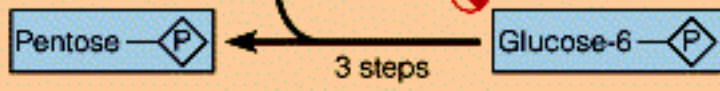

Insulin

Insulin is a peptide hormone that functions in lowering blood glucose levels. **Insulin** has several activities that accomplish this goal, summarized below:

1. **Insulin** inhibits transcription of the enzyme phosphoenolpyruvate carboxykinase (**PEPCK**). PEPCK is a key enzyme in gluconeogenesis and transcription is the primary means of regulating it. By inhibiting PEPCK transcription, **insulin** can depress **glucose** production tremendously. (Conversely, the hormone **glucagon**, which increases blood glucose levels, stimulates PEPCK transcription.)
2. **Insulin** stimulates translocation of the glucose transporter protein from cytosol to the cell surface. Glucose transport protein carries out the facilitated transport of glucose.
3. **Insulin** stimulates phosphatase activity which removes phosphates from molecules activated by the **kinase cascade**. Thus, **insulin** opposes the effects of glucagon and **epinephrine**.

Insulin also stimulates fatty acid biosynthesis (see [here](#)) (**Figure 18.34**) as follows:

1. **Insulin** favors entry of glucose into cells, which, in turn, favors production of NADPH via entry of glucose-6-phosphate into the pentose phosphate pathway.
2. **Insulin** activates the **pyruvate dehydrogenase complex**, which favors production of acetyl-CoA.
3. **Insulin** tends to reverse the effects of the kinase cascade, and stimulates dephosphorylation of **acetyl-CoA carboxylase**, which favors polymerization of the enzyme in an active form.

See also: [Action of Insulin](#) (from Chapter 23), [Gluconeogenesis](#), [Control of Fatty Acid Synthesis](#), [Hormonal Regulation of Fuel Metabolism](#), [Figure 5.21](#), [Table 23.2](#)

Phosphoenolpyruvate Carboxykinase (PEPCK)

PEPCK is an enzyme of [gluconeogenesis](#). It catalyzes conversion of the 4-carbon compound, oxaloacetate, to phosphoenolpyruvate (PEP), releasing CO₂. The reaction requires energy input from GTP and produces GDP.

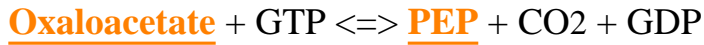

For **PEPCK** to function in gluconeogenesis, oxaloacetate produced in the pyruvate carboxylase reaction in the mitochondria, must be transported to the cytoplasm. **PEPCK** is not under any known allosteric control. Activity of the enzyme is regulated by hormonal control of its transcription. [Glucagon](#) stimulates transcription of the structural gene for **PEPCK**. [Insulin](#) inhibits transcription of the enzyme. By inhibiting **PEPCK** gene transcription, insulin tends to depress gluconeogenesis rates.

See also: [Enzymes of Gluconeogenesis](#), [Enzymes of Glycolysis](#), [Pyruvate Carboxylase](#); [Pyruvate Kinase](#)

INTERNET LINKS:

1. [RasMol Image of PEPCK](#) (slow)
 2. [Glycolysis/Gluconeogenesis](#)
-

Phosphoenol Pyruvate (PEP)

PEP is a high energy intermediate of glycolysis, gluconeogenesis, and the C₄ plant cycle for concentrating CO₂. The high energy phosphate of **PEP** contains sufficient for substrate level phosphorylation of ADP to form ATP and pyruvate, as shown below:

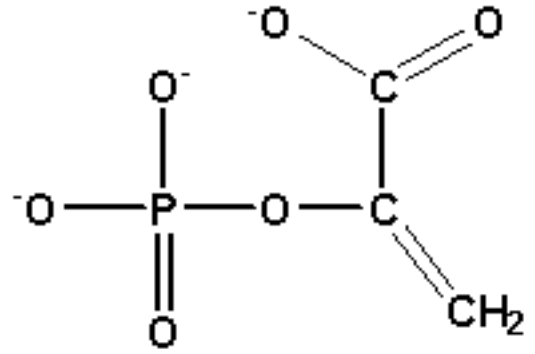

Phosphoenol Pyruvate (PEP)

PEP functions in the PEP-dependent phosphotransferase system (PTS) of *E. coli*, which transports and phosphorylates sugars. **PEP** is used in synthesis of N-acetylneuraminic acid 9-phosphate ([Figure 16.14](#))

Enzymes that act on **PEP** include PEPCK, enolase, pyruvate kinase, pyruvate-phosphate dikinase, PEP Carboxylase, and 5-enoylpyruvylshikimate-3-phosphate synthase (EPSP synthase)

See also: [Glycolysis](#), [Gluconeogenesis](#), [The C₄ Cycle](#) (from Chapter 17), [Glycolysis Reaction Summaries](#), [PEPCK](#), [Enolase](#), [Pyruvate Kinase](#)

INTERNET LINK: [Glycolysis/Gluconeogenesis](#)

Pyruvate Kinase

Pyruvate kinase catalyzes the last step in the process of glycolysis, conversion of the high-energy intermediate, phosphoenolpyruvate (PEP) to pyruvate accompanied by conversion of ADP + Pi to ATP (See [Figure](#)).

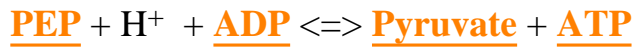

This reaction is one of two substrate level phosphorylations in glycolysis (the other is catalyzed by phosphoglycerate kinase). The enzyme is a key control point for glycolysis.

Pyruvate kinase is inhibited by ATP, activated by [fructose-1,6-bisphosphate](#) (feedforward activation), and inhibited by [acetyl-CoA](#). It is also responsive to hormonally-regulated phosphorylation in the liver - the phosphorylated form of the enzyme is less active. [Alanine](#) is also an inhibitor of the enzyme.

Human deficiency of erythrocyte **pyruvate kinase** leads to excessive blood levels of glycolytic intermediates and, importantly [2,3 bisphosphoglycerate](#).

[Glucagon](#) represses synthesis of **pyruvate kinase**.

[Previous step](#) of glycolysis

See also: [Enzymes of Glycolysis](#), [Molecules of Glycolysis](#), [Glycolysis](#), [Pyruvate Kinase Regulation](#), [Pyruvate Kinase Isozymes](#), [Substrate Level Phosphorylation](#), [Phosphoglycerate Kinase](#), [Action of Glucagon](#)

INTERNET LINKS:

1. [RasMol Image of Pyruvate Kinase](#) (slow)
 2. [Glycolysis/Gluconeogenesis](#)
-

Unnumbered Item

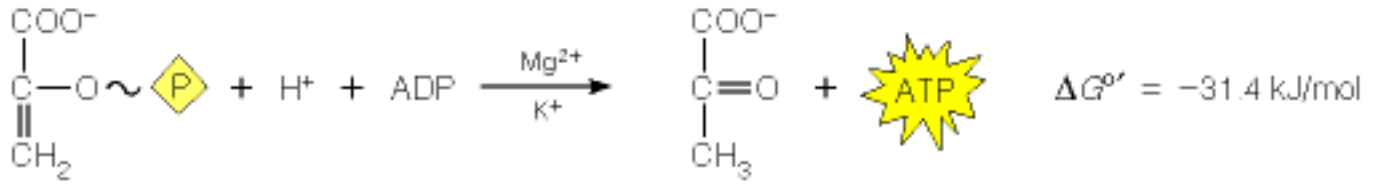

Phosphoenolpyruvate

Pyruvate

2,3-Bisphosphoglycerate (2,3-BPG)

2,3-bisphosphoglycerate compound (also called **glycerate-2,3-bisphosphate**) has two important biological activities.

1. **2,3-bisphosphoglycerate** is formed both by **phosphoglycerate mutase** (transiently) and **bisphosphoglycerate mutase**. The mechanism of the reaction catalyzed by phosphoglycerate mutase involves formation of **2,3-bisphosphoglycerate** via transient phosphorylation of a **histidine** residue of the enzyme. **2,3BPG** can diffuse from phosphoglycerate mutase, however, leaving the enzyme trapped in an unusable state. Cells make excess **2,3BPG** (using the enzyme bisphosphoglycerate mutase) in order to drive **2,3BPG** back to phosphoglycerate mutase, so the reaction can go to completion.

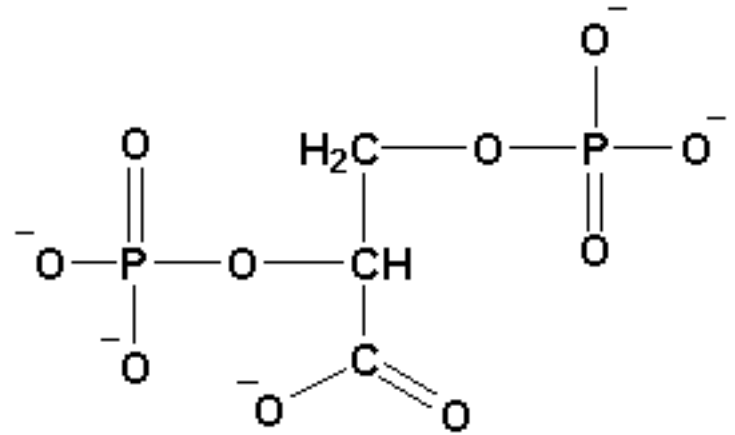

2,3-Bisphosphoglycerate

2. As **Figure 7.18** shows, **2,3-BPG** binds in the cavity between the β chains of **hemoglobin**, making electrostatic interactions with positively charged groups surrounding this opening. Comparison of the two hemoglobin conformations shown in **Figure 7.12b** shows that this opening is much narrower in oxyhemoglobin than in deoxyhemoglobin. In fact, **2,3-BPG** cannot be accommodated in the oxy form. The higher the **2,3-BPG** content in red blood cells, the more stable the deoxy structure will be. The decrease in O₂ affinity by hemoglobin is explained by stabilization of the deoxy structure. Increased **2,3-BPG** levels are also found in the blood of smokers, who because of the carbon monoxide in smoke also suffer from limitation in oxygen supply.

See also: **[Bisphosphoglycerate and Hemoglobin](#)** (from Chapter 7)

INTERNET LINKS: **[Glycolysis/Gluconeogenesis](#)**

Phosphoglycerate Mutase

Phosphoglycerate mutase catalyzes the interconversion of 3-phosphoglycerate (3PG) and 2-phosphoglycerate (2PG) in the glycolysis and gluconeogenesis pathways (See [Figure](#)).

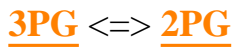

The mechanism of the reaction catalyzed by phosphoglycerate mutase involves formation of [2,3-bisphosphoglycerate](#) via transient phosphorylation of a [histidine](#) residue of the enzyme. 2,3BPG can diffuse from phosphoglycerate mutase, however, leaving the enzyme trapped in an unusable state. Cells make excess 2,3BPG (using the enzyme bisphosphoglycerate mutase) in order to drive 2,3BPG back to phosphoglycerate mutase, so the reaction can go to completion.

[Previous step](#) of glycolysis; [Next step](#) of glycolysis

See also: [Enzymes of glycolysis](#), [Molecules of Glycolysis](#), [Glycolysis](#), [Gluconeogenesis](#), [Bisphosphoglycerate Mutase](#)

INTERNET LINKS:

1. [RasMol Image of Phosphoglycerate Mutase](#) (slow)
 2. [Glycolysis/Gluconeogenesis](#)
-

Unnumbered Item

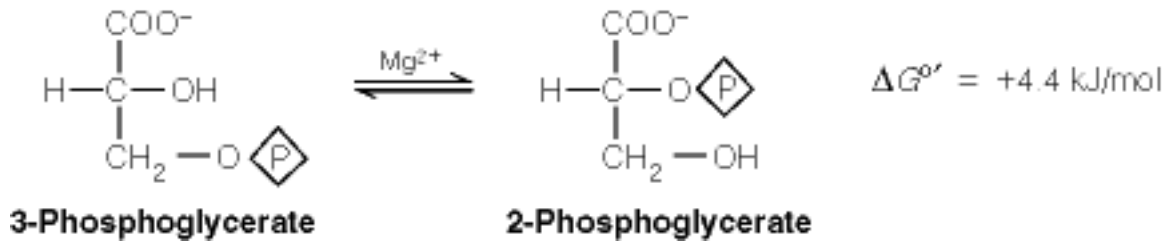

2-Phosphoglycerate (2PG)

2-Phosphoglycerate is an intermediate in the [glycolysis](#) and [gluconeogenesis](#) pathways.

2-Phosphoglycerate is acted on by the glycolytic enzymes [phosphoglycerate mutase](#) and [enolase](#). When fluoride ion is added to yeast extracts undergoing fermentation, **2-phosphoglycerate** is one of the products that accumulates. This is due to inhibition of the enolase enzyme by the fluoride ion.

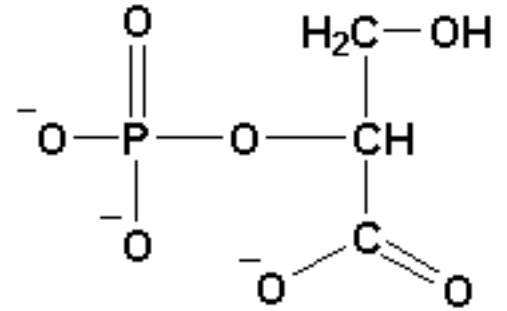

2-Phosphoglycerate

See also: [2,3 Bisphosphoglycerate](#)

INTERNET LINK: [Glycolysis/Gluconeogenesis](#)

Enolase

The enzyme **enolase** catalyzes the interconversion of 2-phosphoglycerate and phosphoenolpyruvate.



The reaction, which involves removal of a water molecule from 2-phosphoglycerate to form phosphoenolpyruvate, occurs in both glycolysis and gluconeogenesis .

Previous step of glycolysis; Next step of glycolysis

See also: [Glycolysis](#), [Gluconeogenesis](#), [Enzymes and Reactions of glycolysis](#), [Reaction Picture](#)

INTERNET LINKS:

1. [RasMol \(slow\) Structure](#)
 2. [Glycolysis/Gluconeogenesis](#)
-

Bisphosphoglycerate Mutase



Bisphosphoglycerate mutase catalyzes formation of 2,3 bisphosphoglycerate from 1,3 bisphosphoglycerate. This reaction is important for maintaining the 3-phosphoglycerate mutase reaction.

2,3-bisphosphoglycerate is formed both by phosphoglycerate mutase (transiently) and bisphosphoglycerate mutase. The mechanism of the reaction catalyzed by phosphoglycerate mutase involves formation of 2,3-bisphosphoglycerate via transient phosphorylation of a histidine residue of the enzyme. 2,3BPG can diffuse from phosphoglycerate mutase, however, leaving the enzyme trapped in an unusable state. Cells make excess 2,3BPG (using the enzyme **bisphosphoglycerate mutase**) in order to drive 2,3BPG back to phosphoglycerate mutase, so the reaction can go to completion.

See also: 3-Phosphoglycerate Mutase

Phosphoglycerate Kinase

Phosphoglycerate kinase catalyzes the interconversion of 1,3-bisphosphoglycerate (1,3BPG) and 3-phosphoglycerate (3PG) (see [here](#)).



The reaction involves a substrate-level phosphorylation in which phosphate from 1,3BPG is transferred to ADP to form ATP. The enzyme functions in the glycolysis, gluconeogenesis, and [Calvin cycle](#) pathways.

[Previous step](#) of glycolysis; [Next step](#) of glycolysis

See also: [Enzymes of Glycolysis](#), [Molecules of Glycolysis](#), [Glycolysis](#), [Gluconeogenesis](#), [Substrate Level Phosphorylation](#)

INTERNET LINKS:

1. [RasMol Image of Phosphoglycerate Kinase](#) (slow)
 2. [Glycolysis/Gluconeogenesis](#)
-

Unnumbered Item

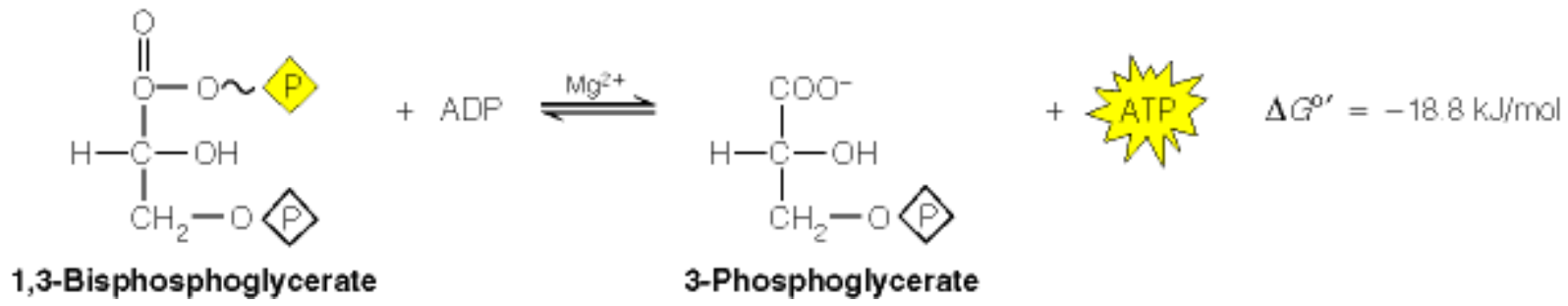

Molecular Intermediates of Glycolysis



Links to the **molecular intermediates of glycolysis** are listed in order of their appearance in the pathway below.

[α-D-Glucose](#)

[α-D-Glucose-6-phosphate](#)

[D-Fructose-6-Phosphate](#)

[D-Fructose-1,6-Bisphosphate](#)

[Dihydroxyacetone phosphate](#) + [D-Glyceraldehyde-3-Phosphate](#)

[1,3 Bisphosphoglycerate](#)

[3-Phosphoglycerate](#)

[2-Phosphoglycerate](#)

[Phosphoenolpyruvate](#)

[Pyruvate](#)

See also: [Glycolysis](#), [Glycolysis Reaction Summaries](#), [Molecular Intermediates](#), [Glycolysis/ Gluconeogenesis Regulation](#), [Aerobic vs Anaerobic Glycolysis](#), [Gluconeogenesis](#)

Fructose-2,6-Bisphosphate (F26BP)

F2,6BP is one of the most important compounds involved in allosteric regulation of [glycolysis](#) and [gluconeogenesis](#).

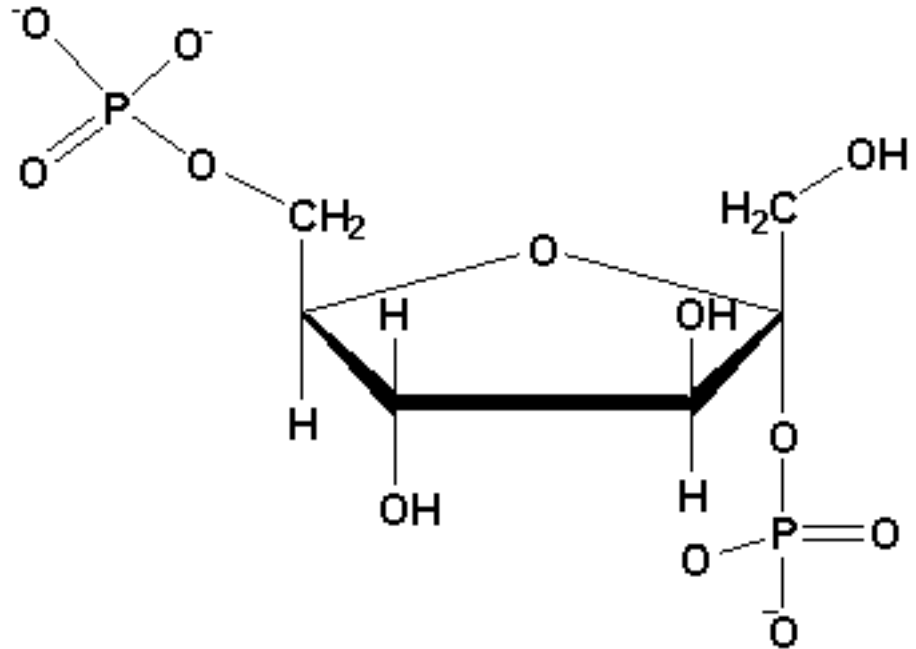

Fructose-2,6-bisphosphate

F2,6BP is made by action of the enzyme [phosphofructokinase-2 \(PFK2\)](#).

In this reaction, [fructose-6-phosphate \(F6P\)](#) is converted to **F2,6BP** by addition of a phosphate from [ATP](#) to position 2 of the molecule ([Figure 16.7](#)).

F2,6BP is broken down to F6P by action of the enzyme [fructose-2,6-bisphosphatase](#), which hydrolyzes the phosphate from position 2, regenerating F6P.

See also: [Glycolysis/Gluconeogenesis Regulation Links Page](#), [Action of Glucagon](#)

Phosphofructokinase-2 (PFK2) / Fructose-2,6-Bisphosphatase (FBPase-2)

PFK2 catalyzes formation of the compound fructose-2,6-bisphosphate (F2,6BP) by transferring a phosphate from ATP onto position 2 of fructose-6-phosphate (F6P) ([Figure 16.7](#)). F2,6BP is the most important allosteric regulator of [glycolysis](#) and [gluconeogenesis](#) and is formed as follows:



PFK2 is a single domain of an enzyme that also contains on it another domain for an enzymatic activity that reverses the effect of the **PFK2**-catalyzed reaction. The other domain is known as **FBPase-2**. **FBPase-2** converts F2,6BP to F6P by hydrolyzing the phosphate at position 2 (liberating Pi), as follows:



(Note that this reaction is not the simple reversal of the **PFK2**-catalyzed reaction, but the F6P is regenerated.) Fructose-2,6-bisphosphatase is strongly inhibited by fructose-6-phosphate.

When the enzyme containing the **PFK2** and **FBPase-2** activities is phosphorylated by the cyclic-AMP-dependent protein kinase ([cAPK](#)), the **FBPase-2** activity is favored and **PFK-2** is inhibited. When the phosphate is removed, **PFK2** activity is favored and **FBPase-2** is inhibited.

Phosphorylation of the **PFK2/FBPase-2** enzyme by cAPK requires [cAMP](#). Levels of cAMP in the cell can be modulated hormonally. [Glucagon](#) and [epinephrine](#) increase cellular cAMP levels (favor gluconeogenesis), whereas [insulin](#), decreases cellular cAMP levels, favoring removal of phosphates (stimulates glycolysis).

See also: [Enzymes of Gluconeogenesis](#), [Enzymes of Glycolysis](#), [Phosphofructokinase](#); [Fructose-1,6-Bisphosphatase](#), [Figure 16.7](#), , [Glycolysis/Gluconeogenesis Regulation Links](#), [The Role of Fructose-2,6-Bisphosphate in Gluconeogenesis Regulation](#) (from Chapter 16)

INTERNET LINK: [Glycolysis/Gluconeogenesis](#)

Figure 16.7: Biosynthesis and degradation of fructose-2,6-bisphosphate by action of a bifunctional enzyme.

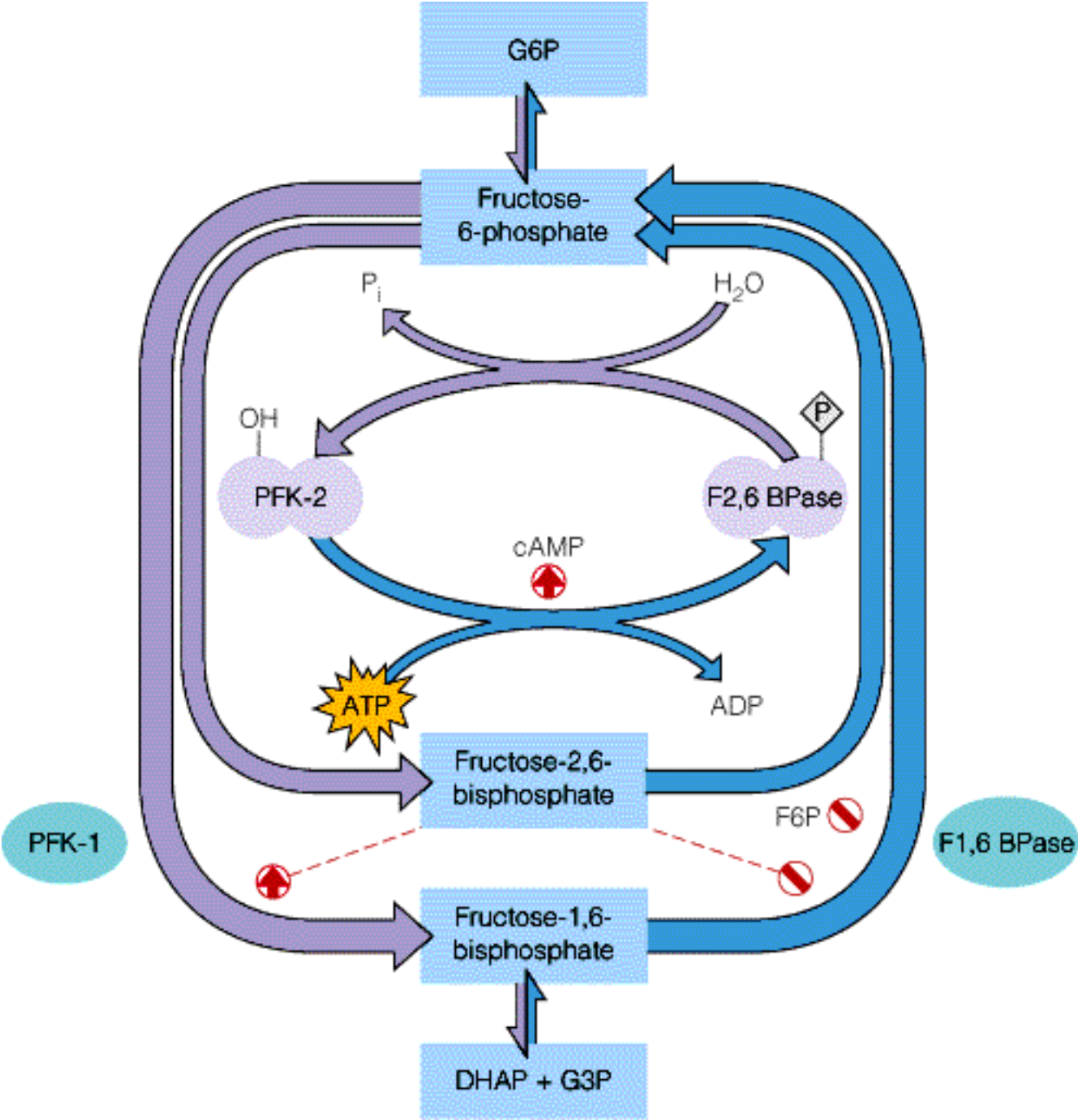

Glucagon

Glucagon is a peptide hormone involved in increasing blood levels of **glucose**.

1. **Glucagon** acts to stimulate production of **cAMP** inside of cells. It does this by binding to a specific receptor that, via interaction with a cell membrane G protein, stimulates the activity of the enzyme responsible for making cAMP, adenylate cyclase. cAMP acts as a "second messenger," conveying the signal from outside the cell to the inside and initiating the cell's response. Pathways affected by cAMP include glycogen metabolism, glycolysis, fatty acid biosynthesis.
2. **Glucagon** stimulates transcription of the enzyme phosphoenolpyruvate carboxykinase (**PEPCK**). PEPCK is a key enzyme in gluconeogenesis and transcription is the primary means of regulating it. By stimulating PEPCK transcription, **glucagon** can favor gluconeogenesis over glycolysis. (Conversely, the hormone **insulin**, which decreases blood glucose levels, stimulates PEPCK transcription.)
3. **Glucagon** represses synthesis of pyruvate kinase, the last enzyme in the glycolytic pathway. This has the effect of favoring gluconeogenesis over glycolysis.

Note that transcription regulation mechanisms are relatively long-term effects (hours to days). When glucose levels need to be increased rapidly (in an emergency, for example), other mechanisms, such as stimulation of glycogen breakdown, must be employed. In this regard, **glucagon** differs from epinephrine. Both **glucagon** and epinephrine act to stimulate production of cAMP which stimulates glucose production, but epinephrine has no long term effects, as does **glucagon**.

See also: [Kinase Cascade](#), [Action of Glucagon](#), [Phosphoenolpyruvate](#), [Glycolysis](#), [Pyruvate Kinase](#), [Epinephrine](#)

Kinase Cascade



Glycogen metabolism (and other metabolic pathways, as well) is regulated by phosphorylation and dephosphorylation of a set of proteins. These are depicted in [Figure 13.18](#), [Figure 16.11](#), and [Figure 16.12](#). The reactions in the phosphorylation occur in a cascading mechanism, referred to here as a **kinase cascade**. It operates as follows in the cell:

1. Stimulus for phosphorylation is hormone interaction ([glucagon](#) or [epinephrine](#)) with a cellular receptor, which sends a signal via a G protein to the membrane-bound enzyme, adenylylase.
2. [Adenylylase](#), in turn, forms [cAMP](#) from [ATP](#).
3. [cAMP](#) activates [cAMP-dependent protein kinase](#).
4. [cAMP-dependent protein kinase](#) phosphorylates [phosphorylase b kinase](#).
5. [Phosphorylase b kinase](#) phosphorylates [glycogen phosphorylase b](#) to convert it to [glycogen phosphorylase a](#).
6. [Glycogen phosphorylase a](#) catalyzes [phosphorolysis](#) of [glycogen](#) to form [glucose-1-phosphate](#).

Phosphorylation of proteins in glycogen metabolism favors glycogen breakdown, inhibits glycogen synthesis

Coincident with stimulating glycogen breakdown, cAMP exerts two effects in inhibiting glycogen synthesis:

1. Phosphorylation of [glycogen synthase](#), converting it to a form dependent on [glucose-6-phosphate](#).
2. Inhibition of [phosphoprotein phosphatase](#) (PP-1), whose activity would tend to restore activity of glycogen synthase. PP-1 and other phosphoprotein phosphatases play converse roles in glycogenolysis, in which dephosphorylation of glycogen phosphorylase b kinase (SPK) causes its inactivation.

See also: [Calmodulin](#), [Mechanism of Activating Glycogen Breakdown](#), [Glycogen Breakdown](#)

Regulation, Glycogen Breakdown, Kinase Cascade in Fat Mobilization (from Chapter 18), **Second Messenger Systems**

Figure 16.11: Regulatory cascades affecting glycogen synthesis and mobilization.

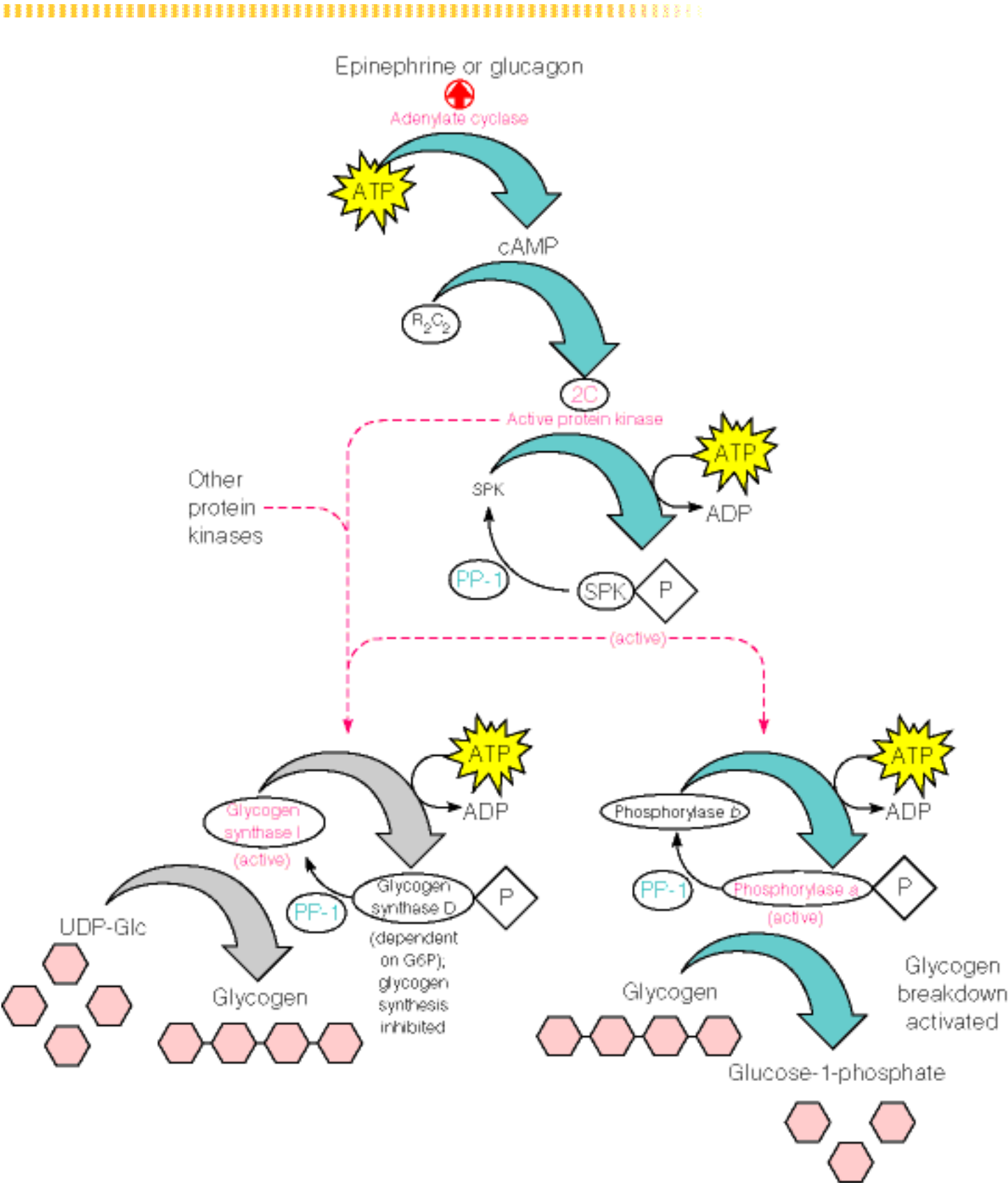
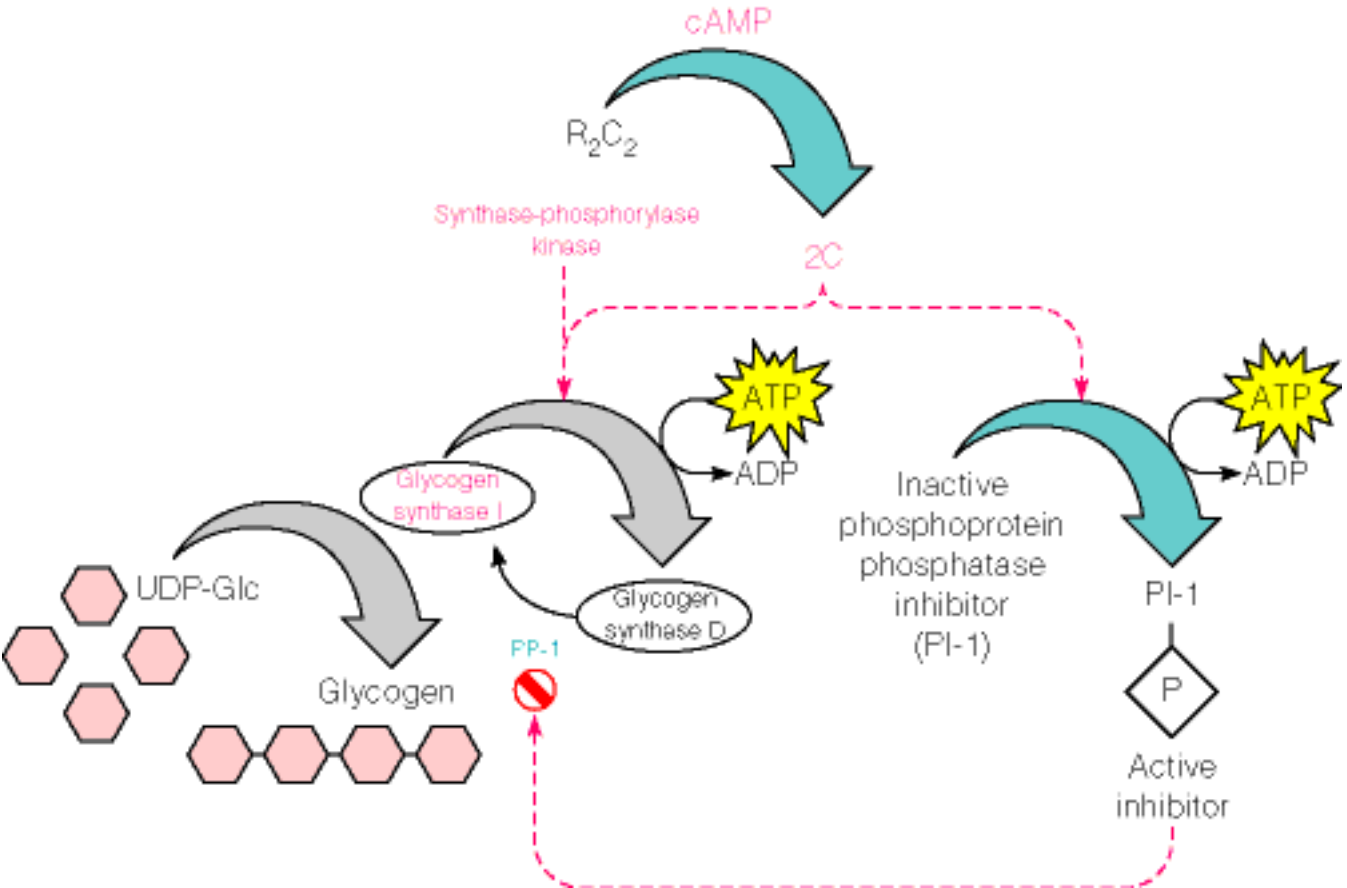

Figure 16.12: Regulation of glycogen synthase activity through cAMP-mediated control of phosphoprotein phosphatase (PP-1) activity.



Glycogen Phosphorylase a

Glycogen phosphorylase a is the more active form of [glycogen phosphorylase](#). It catalyzes the phosphorolysis of [glycogen](#) to form [glucose-1-phosphate](#). Two features distinguish **glycogen phosphorylase a** from the **b** form:

1. The a form is derived from the b form by phosphorylation of the b form by the enzyme [glycogen phosphorylase b kinase](#) ([Figure 13.18](#)).
2. The b form requires [AMP](#) for allosteric activation and is thus active only when cells are at a low energy state.

See also: [Glycogen Phosphorylase b](#), [Glycogen Breakdown](#), [Mechanism of Activating Glycogen Breakdown](#), [Kinase Cascade](#), [Glycogen Breakdown Regulation](#), [Phosphorolysis](#)

Glycogen Breakdown

The breakdown of **glycogen** (glycogenolysis) requires two enzymes, **glycogen phosphorylase** and (α1,4 → α1,4) glucantransferase (a "**Debranching Enzyme**"). Glycogen phosphorylase catalyzes the phosphorolytic cleavage of α(1→4) bonds, generating glucose-1-phosphate in the process. The branch points of glycogen are comprised of α(1→6) bonds, however and **glycogen phosphorylase** does not cleave within four glucose units of an α(1→6) bond. Instead, the **debranching enzyme**, transfers three of the four glucoses to another branch and hydrolytically cleaves the remaining glucose as free glucose (**Figure 13.17**).

Glycogen phosphorylase is present in two forms, **glycogen phosphorylase a** (the active form) and **glycogen phosphorylase b** (the relatively inactive form). **Phosphorylase a** is phosphorylated at a serine residue whereas **phosphorylase b** is not. The two forms are interconverted by **phosphorylase b kinase** (which puts phosphates on) or a phosphatase (which takes phosphates off).

See also: [Glycogen Breakdown Regulation](#), [Mechanism of Activating Glycogen Breakdown](#), [Glucose-1-phosphate](#), [Reciprocal Regulation of Glycogen Biosynthesis and Mobilization](#) (from Chapter 16), [Kinase Cascade](#)

Debranching Enzyme (Amylo-1,6-Glucosidase)

Debranching enzyme catalyzes a reaction in the breakdown of starch in which $\alpha(1\rightarrow6)$ bonds at branches of the polysaccharide are cleaved. This allows the enzyme, α -amylase to continue to cleave $\alpha 1\rightarrow4$ bonds in the molecule.

See also: α -Amylase, Glycogen

Starch

Starch is a polymer of glucose used for energy storage in plants. **Starch** is actually a mixture of two compounds, amylose (unbranched with glucose units linked α 1,4) and amylopectin (α 1,4 links with α 1,6 links approximately every 25-30 glucose residues).

See also: [Glycogen](#), [Glucose](#), [Amylose](#), [Amylopectin](#)

INTERNET LINK: [Starch and Sucrose Metabolism](#)

Amylose

Amylose is a component of [starch](#). The other component, amylopectin, is structurally different from **amylose**. **Amylose** is composed of a polymer of glucose with links exclusively in the α 1,4 orientation, whereas amylopectin contains α 1,6 branches in addition to the α 1,4 linkages. The unbranched structure of **amylose** causes the polymer to exist as a long, coiled helix under conditions when it can be stabilized. One substance that will stabilize an **amylose** helix is iodine, which fits into the hollow core of the structure. Binding of iodine to amylose helices produces an intense blue color and has long been used as a qualitative test for starch. Polymers consisting solely of glucose are called glucans.

See also: [Amylopectin](#), [Glucose](#)

Amylopectin

Amylopectin together with amylose compose [starch](#), the primary storage polysaccharides of plants. **Amylopectin** is a polymer of [glucose](#). It differs from amylose and resembles the animal storage polysaccharide, glycogen, in containing α 1,6 branches in addition to α 1,4 links between glucose units. **Amylopectin** is less branched, however, than glycogen, having branches approximately every 10-20 residues, versus every 8 residues in glycogen. [Amylose](#), **amylopectin**, and glycogen all differ from the polysaccharide, cellulose, in containing exclusively α 1,4 bonds in contrast to the β 1,4 bonds of cellulose.

See also: [Polysaccharides](#), [Glycogen](#)

α -Amylase

α -**Amylase** cleaves internal $\alpha(1 \rightarrow 4)$ linkages of starch and glycogen. In the intestine, digestion continues, aided by α -**amylase** secreted by the pancreas. α -**Amylase** degrades amylose to **maltose** and a little **glucose**. However, it only partially degrades **amylopectin** and **glycogen**, as shown in **Figure 13.16**, because it cannot cleave the $\alpha(1 \rightarrow 6)$ linkages found at branch points. The product of exhaustive digestion of amylopectin or glycogen by α -**amylase** is called a limit dextrin; its continued degradation requires the action of a "**debranching enzyme**," $\alpha(1 \rightarrow 6)$ -glucosidase (also called isomaltase). This action exposes a new group of $\alpha(1 \rightarrow 4)$ -linked branches, which can be attacked by α -**amylase** until a new set of $\alpha(1 \rightarrow 6)$ -linked branches is reached. The end result of the sequential action of these two enzymes is the complete breakdown of starch or glycogen to maltose and some glucose. Maltose is cleaved hydrolytically by maltase, yielding 2 moles of glucose, which is then absorbed into the bloodstream and transported to various tissues for utilization.

See also: **Starch**, **Amylose**, **Maltase**

Figure 13.16: Sequential digestion of amylopectin or glycogen by α -amylase and $\alpha(1-6)$ -glucosidase.

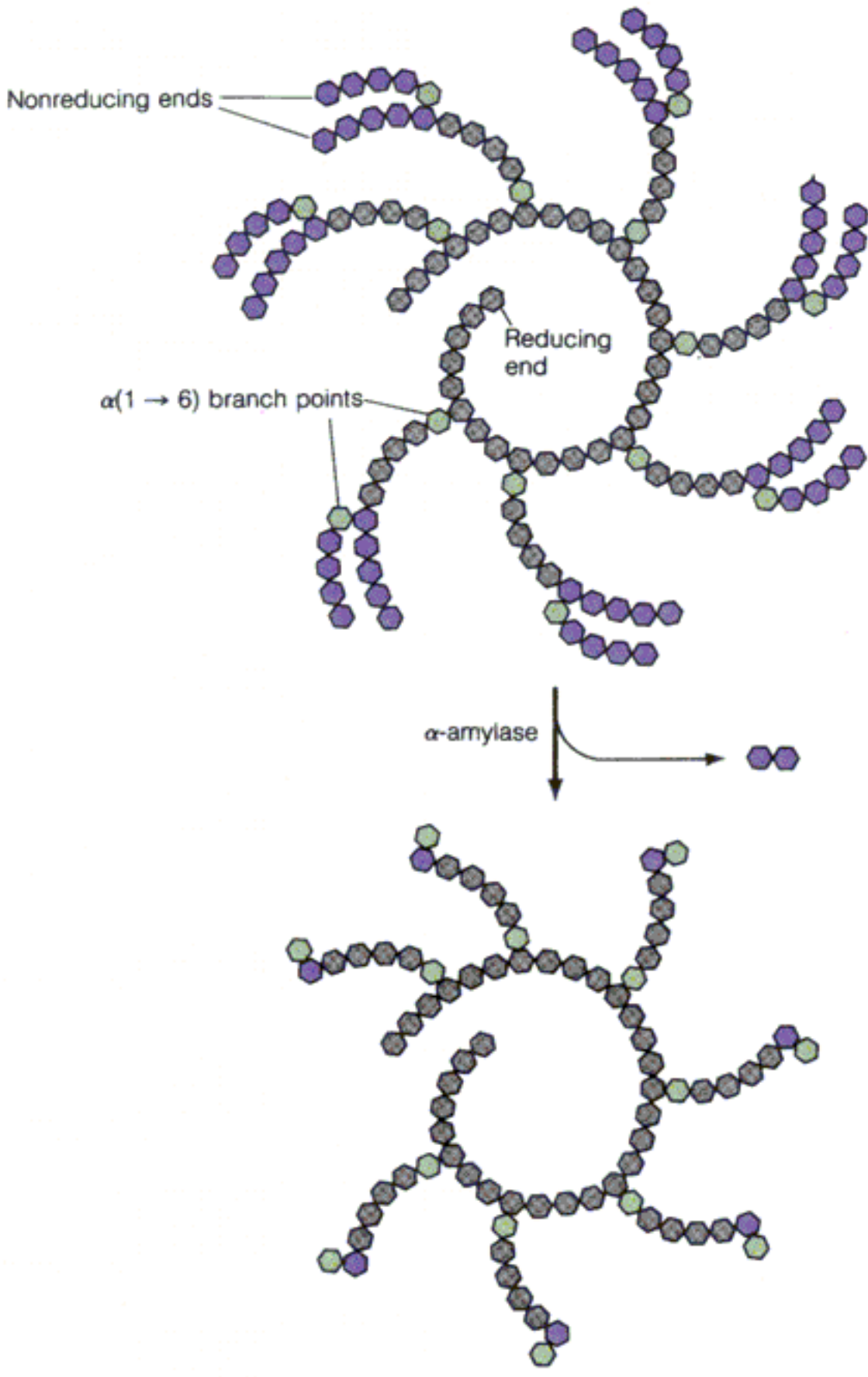

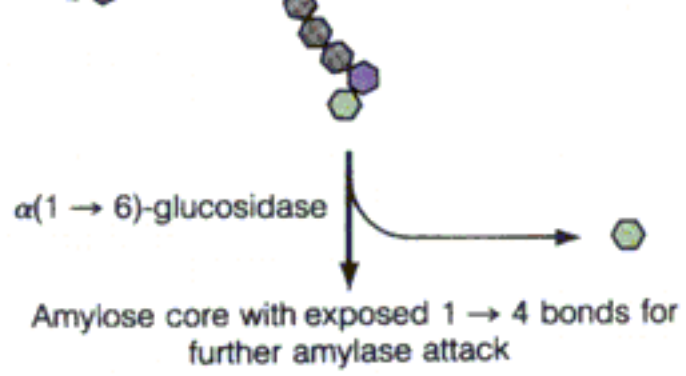

Maltase



Maltase catalyzes the hydrolysis of maltose to two units of glucose.

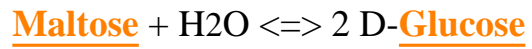

See also: [Catabolism of Other Saccharides](#)

Catabolism of Other Saccharides

Besides **glucose**, the digestion of foodstuffs and the utilization of endogenous metabolites can supply a variety of carbohydrates for glycolysis. These include the other monosaccharides (sugars), disaccharides, and polysaccharides. The metabolic routes for utilizing substrates other than glucose in glycolysis are summarized in **Figure 13.12**.

Monosaccharide Sugars

Galactose, **mannose**, and **fructose** are the main sugars of interest. All can be phosphorylated at position six by **hexokinase** and **ATP**. In addition, fructose can enter the glycolytic pathway as fructose-1-phosphate, which is then broken down to D-glyceraldehyde and DHAP (see **here**). Galactose can also be converted to glucose via the **UDP-galactose-4-epimerase** catalyzed pathway (**Figure 13.14**)

Disaccharides

The enzyme **lactase** breaks down the disaccharide **lactose** to yield the monosaccharides galactose and glucose. **Maltase** breaks down **maltose** to yield two molecules of glucose. **Sucrase** breaks down **sucrose** to yield fructose and glucose. All of these monosaccharides subsequently enter glycolysis as shown in **Figure 13.12**.

Polysaccharides

Glycogen (from animals), starch (e.g., **amylose** and **amylopectin** from plants), and **cellulose** (from plants) are the main polysaccharides of interest. Amylose and cellulose are linear polymers, whereas glycogen and amylopectin are branched polymers.

The breakdown of glycogen requires two enzymes, **glycogen phosphorylase** and (α 1,4 \rightarrow α 1,4) glucantransferase (a so-called "**debranching enzyme**"). Glycogen phosphorylase cleaves the α (1 \rightarrow 4) linkages between glucose units in the linear chains in glycogen, yielding **glucose-1-phosphate** in the process. Glycogen phosphorylase cannot cleave the α (1 \rightarrow 6) linkages at the branch points, however, but the debranching enzyme can, yielding glucose and more α (1 \rightarrow 4) linked chains (see **Figure 13.17**)

The breakdown of starch (amylose and amylopectin) also requires two enzymes, α -**amylase**, and α (1 \rightarrow 6) glucosidase (another "debranching enzyme"). α -Amylase cleaves

the $\alpha(1\rightarrow4)$ linkages in amylose and amylopectin. Because amylose is a linear polymer, α -amylase breaks it down completely to maltose and a small amount of glucose. However, because amylopectin is a branched polymer, α -amylase breaks it down until a branch point is encountered. The debranching enzyme then cleaves the $\alpha(1\rightarrow6)$ bond of the branch point, thus exposing a new set of $\alpha(1\rightarrow4)$ linkages for α -amylase to attack (see [Figure 13.16](#)).

Cellulose is the single most abundant polymer in the biosphere. Like amylose, it is a polymer. Unlike amylose, however, the linkages between glucose units in cellulose are $\beta(1\rightarrow4)$ bonds instead of $\alpha(1\rightarrow4)$ bonds. Thus, enzymes called cellulases are needed to cleave the $\beta(1\rightarrow4)$ bonds in cellulose. It turns out, however, that only ruminants, such as cows, termites, and certain fungi, such as mushrooms, possess the necessary cellulases to digest cellulose. Ruminants and termites have the required enzymes only because their respective digestive tracts contain symbiotic bacteria that produce cellulases.

See also: [Disaccharides](#)

Figure 13.12: Routes for utilizing substrates other than glucose in glycolysis.

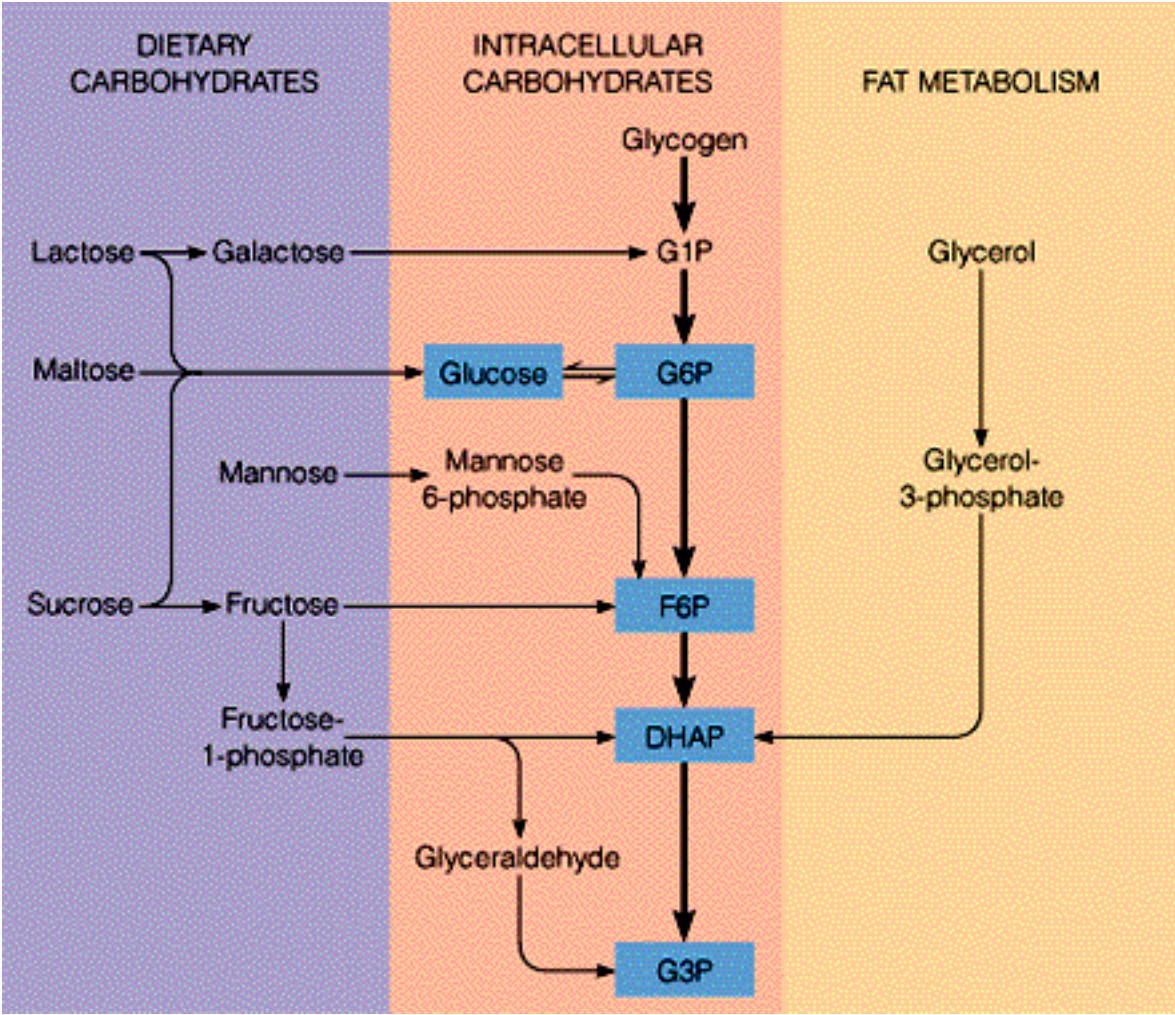

Fructose-1,6-Bisphosphate Aldolase B

In vertebrate liver, the enzyme fructokinase phosphorylates fructose to fructose-1-phosphate (F1P). F1P is then cleaved by a specific enzyme, **aldolase B** to dihydroxyacetone phosphate (DHAP), a glycolytic intermediate, and D-glyceraldehyde (see below). The latter is then phosphorylated in an ATP-dependent reaction to give the glycolytic intermediate glyceraldehyde-3-phosphate.



This pathway of utilization bypasses phosphofructokinase regulation and may account for the ease with which dietary sucrose is converted to fat.

See also: Sucrose, Phosphofructokinase

Fructokinase



Fructokinase catalyzes phosphorylation of fructose to fructose-1-phosphate (F1P).

See also: [Fructose](#), [Fructose-1-Phosphate Aldolase B](#), [Fructose Metabolism](#)

Fructose-1-Phosphate (F1P)

F1P is formed by action of the enzyme **fructokinase** on **fructose** and **ATP**. **F1P** is subsequently broken down by aldolase B to **dihydroxyacetone phosphate**, a glycolytic intermediate, and **D-glyceraldehyde**.

See also: **Aldolase B**

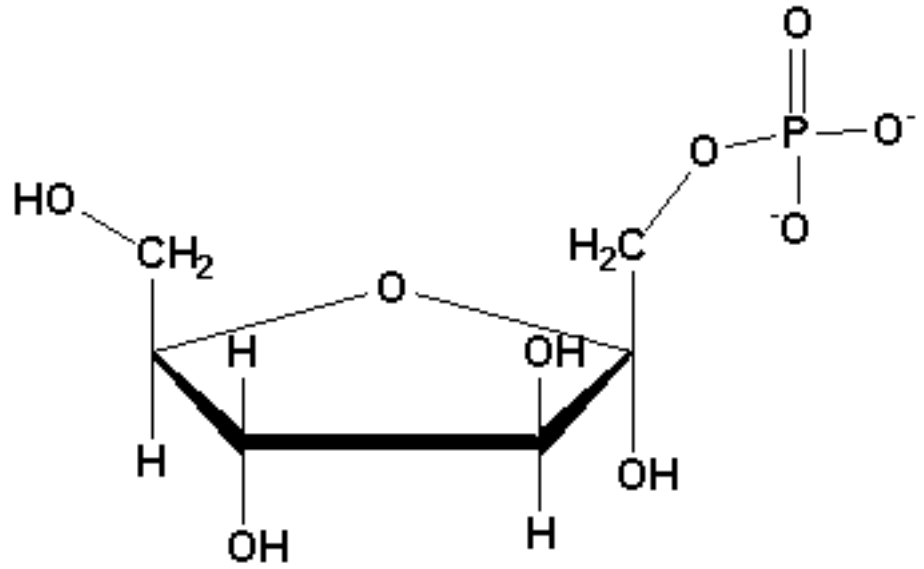

Fructose-1-phosphate

Glyceraldehyde

Glyceraldehyde is a three-carbon monosaccharide containing an aldehyde group. **D-Glyceraldehyde** is formed by action of aldolase B on fructose-1-phosphate.

See also: [Saccharides](#), [Monosaccharides](#), [Monosaccharide Nomenclature](#), [Fructose-1,6-Bisphosphate Aldolase B](#)

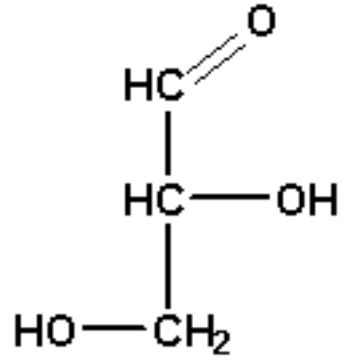

Glyceraldehyde

Monosaccharide Nomenclature

Monosaccharides are the simplest sugars, having the formula $(\text{CH}_2\text{O})_n$. The smallest molecules usually considered to be **monosaccharides** are those with $n = 3$.

Monosaccharides can be categorized according to their value of 'n,' as shown below:

n	Category
3	Triose
4	Tetrose
5	Pentose
6	Hexose
7	Heptose
8	Octose

Monosaccharides can exist as aldehydes or ketones and are called **aldoses** or **ketoses**, respectively. For example, ([Figure 9.3](#)) shows the structures of **glyceraldehyde**, an aldo-triose, and **dihydroxyacetone**, a **keto-triose**. Glyceraldehyde and dihydroxyacetone have the same atomic composition, but differ only in the position of the hydrogens and double bonds. Moreover, they can interconvert via an enediol intermediate ([Figure 9.4](#)). When the structures of molecules are related in these ways, the molecules are called **tautomers**.

Carbons in a monosaccharide are numbered such that the aldehyde group is carbon number one or the ketone group is carbon number two.

The three dimensional arrangement of atoms around a carbon atom are such that if four different groups are attached to it, they can be arranged in two different ways. Such a carbon is described as **chiral** or **asymmetric**. The two molecules with different three-dimensional arrangement are mirror images of each other, and the two different forms are called **stereoisomers**. For example, D-glyceraldehyde and L-glyceraldehyde ([Figure 9.5](#)) are mirror images of each other (stereoisomers) and cannot be superimposed on each other. Such molecules with these properties are called **enantiomers**. The designation 'D-' or 'L-' is an older nomenclature still used widely in biochemistry. It originally described whether the compound rotated a plane of polarized light to the right (D for dextro) or left (L for left). This is not absolute, however, because it depends on the reference compound chosen.

The R-S nomenclature, which is an absolute naming scheme, is shown in [Figure 9.6](#). It is commonly used by organic chemists, but is rarely used by biochemists since it is difficult to apply to molecules, such as tetroses, pentoses, hexoses, etc., which may have more than one chiral carbon. The predominant monosaccharides found in nature have the 'D' configuration.

Sugars with more than one asymmetric carbon have many possible three dimensional configurations. In general a molecule with m chiral centers will have 2^m stereoisomers. The multiple stereoisomeric forms means that not all stereoisomers will be mirror images of each other. Stereoisomers that are not mirror images of each other are called **diastereomers**.

Ketose-aldose pairs of sugars frequently are named by inserting the letters 'ul' in the name of the corresponding aldose to derive the name of the ketose. An example is erythrose - erythrulose.

When sugars cyclize, they typically form **furanose** or **pyranose** structures (Figure 9.10). These are molecules with five-membered or six-membered rings, respectively. Cyclization creates a carbon with two possible orientations of the hydroxyl around it. We refer to this carbon as the **anomeric carbon** and the two possible forms as **anomers**. The two possible configurations of the hydroxyl group are called α and β , which correspond to the hydroxyl being in the "down" and "up" positions, respectively, in standard projections (see here)

Figure 9.13 shows that a pyranose, such as glucose, has two common conformational isomers, referred to as the "boat" and "chair" form. For glucose (and most sugars), the chair form is more stable because the hydroxyls of carbons 1 and 2 are further removed and thus have less steric interference with carbons 3, 4, and 5.

See also: Diastereomers, Sugar Ring Structures, Figure 9.14, Table 9.4

Figure 9.3: Trioses, the simplest monosaccharides.

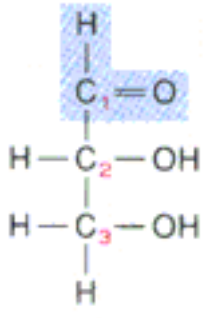

D-Glyceraldehyde
(an aldose)

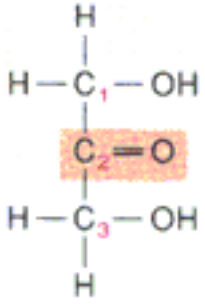

Dihydroxyacetone
(a ketose)

Dihydroxyacetone

Dihydroxyacetone is the simplest ketose. Containing three carbons, it is a keto-triose.

See also: [Monosaccharides](#), [Monosaccharide Nomenclature](#)

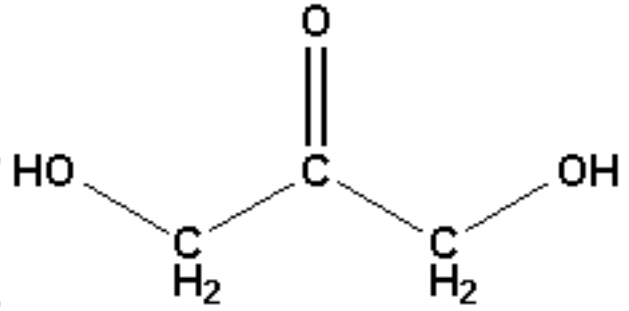

Dihydroxyacetone

Figure 9.4: Aldose-ketose interconversion via an enediol intermediate.

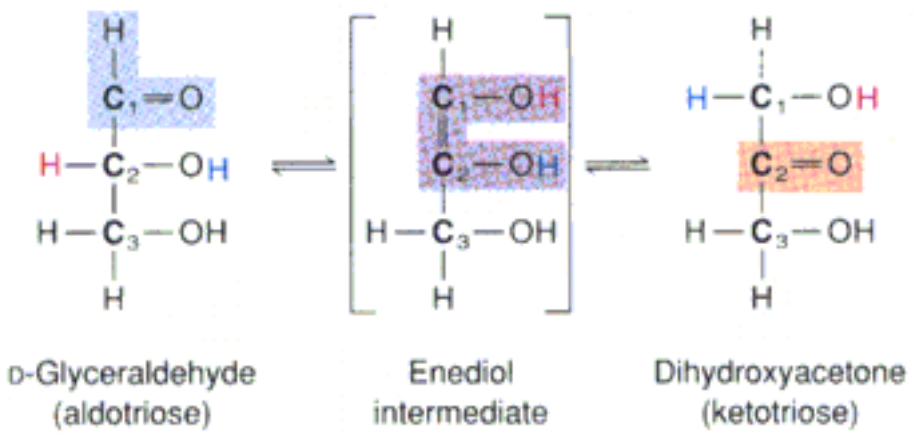
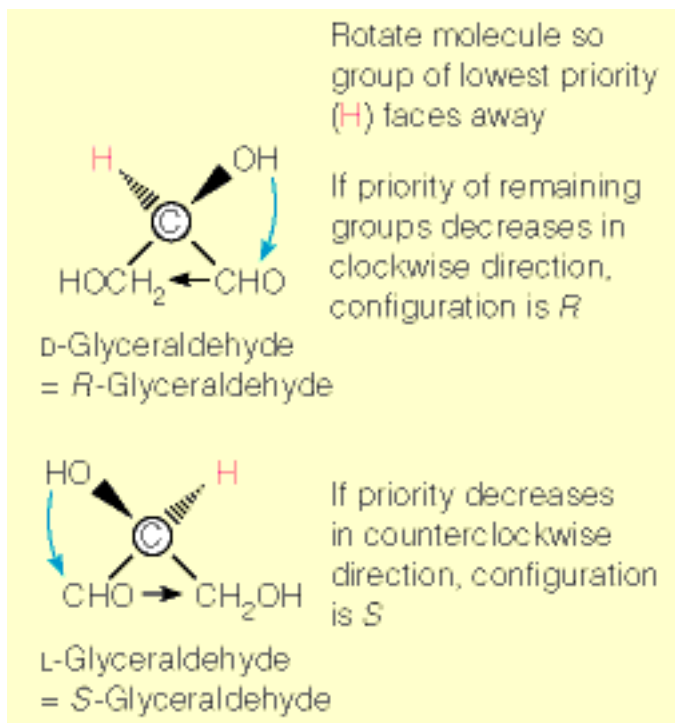

Figure 9.6: R-S nomenclature.



D-Erythrose

D-Erythrose is a four carbon aldehyde-containing sugar, making it an aldotetrose.

See also: [Saccharides](#), [Monosaccharides](#), [Monosaccharide Nomenclature](#)

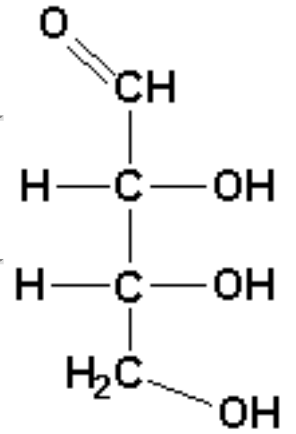

D-erythrose

D-Erythrulose

D-Erythrulose is a four carbon ketone sugar. It is classified as a ketotetrose.

See also: [Saccharides](#), [Monosaccharides](#), [Monosaccharide Nomenclature](#)

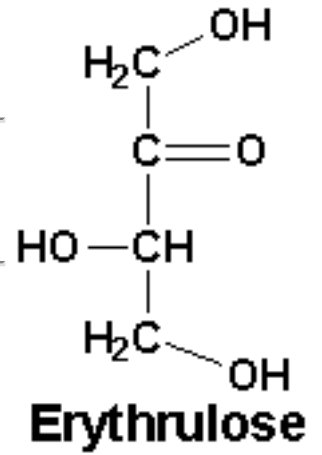
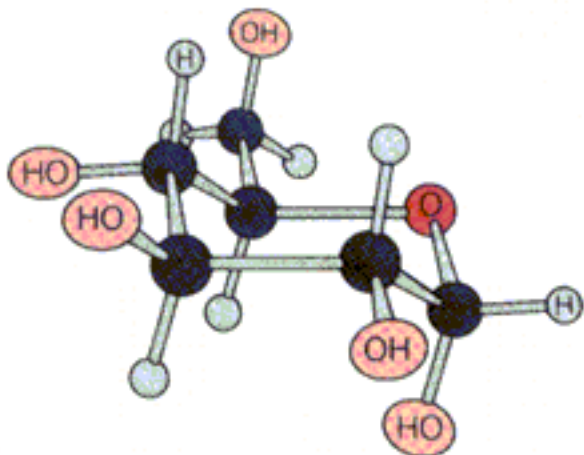
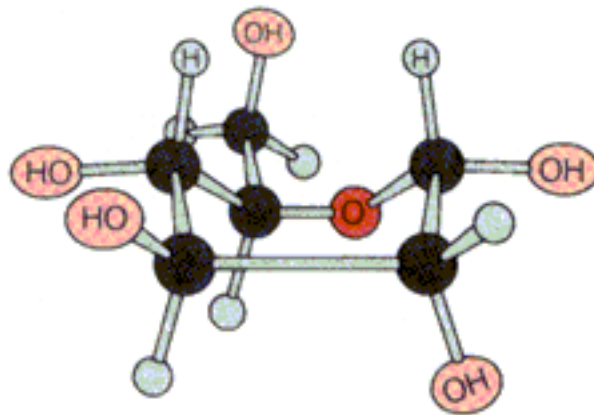

Figure 9.13: The pyranose ring in chair and boat conformations.



Chair



Boat

(a)

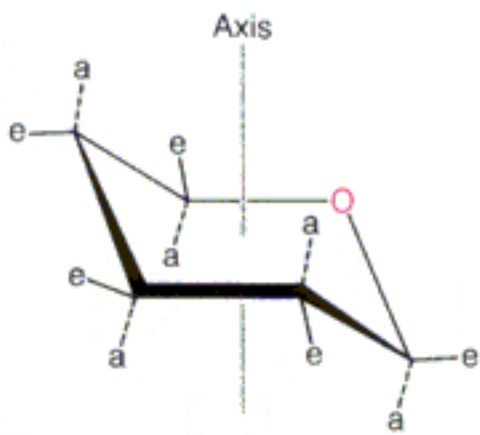

Chair

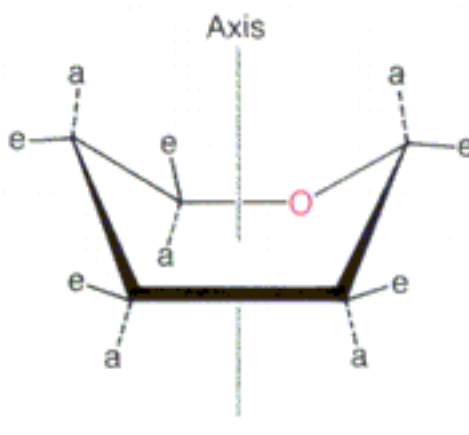

Boat

(b)

D-Idose

D-Idose is a rare hexose.

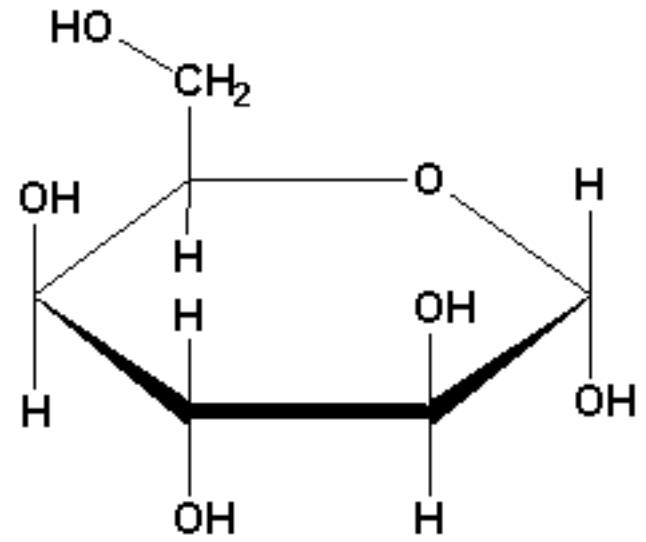

D-Idose

See also: [Diastereomers](#)

D-Talose

D-Talose is a rare hexose.

See also: [Diastereomers](#)

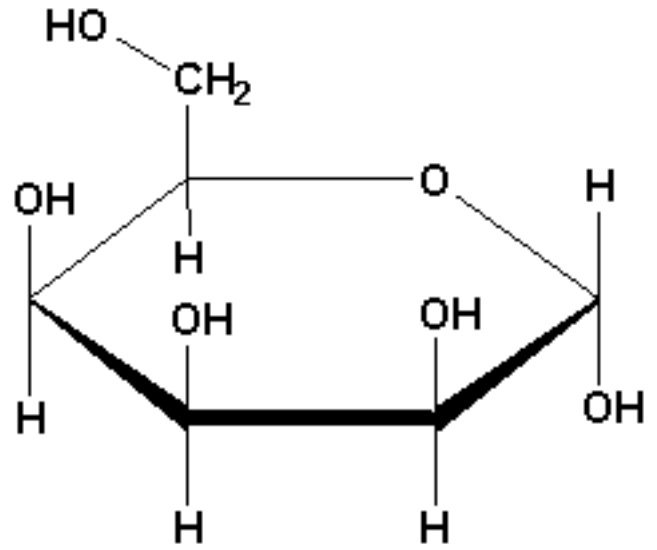

D-Talose

Table 9.4

Monosaccharides

Arabinose	Ara
Fructose	Fru
Fucose	Fuc
Galactose	Gal
Glucose	Glc
Lyxose	Lyx
Mannose	Man
Ribose	Rib
Xylose	Xyl

Monosaccharide Derivatives

Gluconic acid	GlcA
Glucuronic acid	GlcUA
Galactosamine	GalN
Glucosamine	GlcN
<i>N</i> -Acetylgalactosamine	GalNAc
<i>N</i> -Acetylglucosamine	GlcNAc (or NAG)
Muramic acid	Mur
<i>N</i> -Acetylmuramic acid	MurNAc (or NAM)
<i>N</i> -Acetylneuraminic acid (or sialic acid)	NeuNAc (or Sia)

Phosphofructokinase (PFK)

PFK (also called **PFK-1**) is an enzyme of [glycolysis](#) that is a critical control point regulating the pathway. It catalyzes the conversion of fructose-6-phosphate (F6P) to fructose-1,6-bisphosphate (F1,6BP) by adding a phosphate from ATP, creating ADP.



The enzyme is regulated allosterically and the $\Delta G^{\circ\prime}$ of the reaction (-14.2 kJ/mol) is sufficiently negative to make it essentially irreversible in vivo. Consequently gluconeogenesis uses the enzyme [fructose-1,6-bisphosphatase](#) to hydrolyze F1,6BP to F6P. **PFK** is, thus, one of the glycolysis enzymes that is not used in gluconeogenesis.

Allosteric activators of **PFK** include [AMP](#) and [fructose-2,6-bisphosphate](#) (F2,6BP). Inhibitors include ATP and citrate. The most potent of the allosteric regulator of glycolysis and gluconeogenesis is F2,6BP due to its ability to turn on **PFK** and turn off the corresponding gluconeogenesis enzyme, fructose-1,6-bisphosphatase, in very low concentrations.

Higher plants contain two different **PFKs** - the ATP-dependent enzyme described above and a second, unique form that uses pyrophosphate instead of ATP as the phosphorylating agent. The reaction catalyzed is as follows:

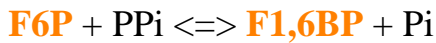

PFK is inhibited by light in plants.

[Previous step](#) of glycolysis; [Next step](#) of glycolysis

See also: [Enzymes of Glycolysis](#), [Gluconeogenesis](#), [Regulation of Glycolysis](#), [Glycolysis/Gluconeogenesis Regulation Links](#), [Regulation of Photosynthesis](#)

INTERNET LINKS:

1. [RasMol Structure of PFK](#) (slow)
 2. [Glycolysis/Gluconeogenesis](#)
-

Fructose-1,6-Bisphosphatase (F1,6BPase)

F1,6BPase is an enzyme in [gluconeogenesis](#) that catalyzes hydrolysis of fructose-1,6-bisphosphate, producing fructose-6-phosphate and Pi.



F1,6BPase is a key regulatory enzyme of gluconeogenesis. It is allosterically inactivated by [fructose-2,6-bisphosphate](#) and AMP (**Figures 16.6** and **16.7**). Synthesis of **F1,6BPase** is also regulated hormonally.

See also: [Regulation of Gluconeogenesis](#), [Fructose-2,6-Bisphosphate in Gluconeogenesis Regulation](#), [Gluconeogenesis Enzymes](#), [Glycolysis Enzymes](#), [AMP](#)

Regulation of Gluconeogenesis

Figure 16.6 shows the primary control mechanisms of [glycolysis](#) and [gluconeogenesis](#). These include allosteric controls of the primary enzymes, hormonal control of enzyme synthesis, and general hormonal regulation. Gluconeogenesis and glycolysis both proceed primarily in the cytosol. Because gluconeogenesis synthesizes glucose and glycolysis catabolizes glucose, the two opposing pathways are controlled in reciprocal fashion. Otherwise, a futile cycle would result.

The control points for the pathways are also the places where the two pathways employ different enzymes. Notice that some compounds, such as [fructose-2,6-bisphosphate](#) (F2,6BP), [AMP](#), and [acetyl-CoA](#) have opposite effects on activities of enzymes in the two pathways. This is one of the mechanisms of the reciprocal regulation.

The enzymes of gluconeogenesis and the mechanisms by which they are controlled are summarized as follows:

[Glucose-6-phosphatase](#) - This enzyme is not known to be allosterically controlled. Its K_M for G6P is far higher than intracellular concentrations of the metabolite. Intracellular activity is controlled in first-order fashion by the concentration of G6P.

[Fructose 1,6 bisphosphatase](#) - The primary regulatory enzyme for gluconeogenesis. Inactivated potently by F2,6BP (See [Figure 16.17](#)) and AMP. Synthesis of the enzyme is sensitive to hormonal control.

[Phosphoenolpyruvate carboxykinase \(PEPCK\)](#) - This enzyme has no known allosteric regulators. The enzyme is controlled by hormonal regulation of its synthesis. The hormone, [glucagon](#), activates transcription of the structural gene for the enzyme. [Insulin](#), on the other hand, inhibits transcription of the gene.

[Pyruvate carboxylase](#) - This enzyme is found only in the mitochondrial matrix, apart from the other enzymes of glycolysis and gluconeogenesis. It can be activated by acetyl-CoA, but it is not clear what role it has in the overall control of the enzyme, since cellular levels of acetyl-CoA are far higher, under most conditions, than the concentration giving half-maximal stimulation.

See also: [Gluconeogenesis/Glycolysis Links Page](#), [Reciprocal Regulation](#), [Relationship of Gluconeogenesis to Glycolysis](#), [Role of Fructose-2,6-Bisphosphate in Gluconeogenesis Regulation](#)

Glycogen Metabolism Diseases

Several of the human **congenital defects of glycogen metabolism** are listed in [Table 16.2](#). These conditions, which are called glycogen storage diseases, usually result from storage of abnormal quantities of glycogen or storage of glycogen with abnormal properties.

Deficiencies of enzymes, such as glucose-6-phosphatase or glucose-6-phosphatase translocase, which are only peripherally related to **glycogen metabolism**, affect the relative levels of glucose and glycogen because their deficiency can drastically alter the normal **metabolism of glucose**. Thus, liver cells lacking glucose-6-phosphatase are unable to make glucose for release into the bloodstream and instead convert the accumulating amounts of [G6P](#) to [G1P](#) and metabolize that to glycogen.

Similarly, **glycogen storage diseases** may result from deficiencies of or defects in the [debranching](#) or [branching enzymes](#). Individuals deficient in debranching enzyme can degrade [glycogen](#) only until branch points are reached and no farther. Individuals with defective debranching enzyme accumulate glycogen with very short outer branches in their livers. Finally, individuals with defective branching enzyme accumulate glycogen with very long outer branches.

See also: [Glycogen Biosynthesis](#), [Glycogen Catabolism](#) (from chapter 13)

Table 16.2



Type	Common Name	Enzyme Deficiency	Glycogen Structure	Organ Affected
Ia	von Gierke's disease	Glucose-6-phosphatase	Normal	Liver, kidney, intestine
Ib		Glucose-6-phosphatase translocase	Normal	Liver
II	Pompe's disease	$\alpha(1\rightarrow4)$ Glucosidase	Normal	Generalized
III	Cori's disease	Debranching enzyme	Short outer chains	Liver, heart, muscle
IV	Andersen's disease	Branching enzyme	Abnormally long unbranched chains	Liver and other organs
V	McArdle-Schmidt-Pearson disease	Muscle glycogen phosphorylase	Normal	Skeletal muscle
VI	Hers' disease	Liver glycogen phosphorylase	Normal	Liver, leukocytes
VII		Muscle phosphofructokinase	Normal	Muscle
VIII		Liver phosphorylase kinase	Normal	Liver

Amylo-(1,4->1,6)-Transglycosylase (Branching Enzyme)



Branching enzyme is responsible in glycogen biosynthesis for making the many 1,6 branches characteristic of the glycogen molecules.

Deficiency of the enzyme causes the severe, and usually fatal, Andersen's disease (see [here](#)). Structure of [glycogen](#) in these individuals is abnormal - long chains of [glucose](#) with very few branches.

See also: [Glycogen Metabolism Diseases](#), [Glycogen Biosynthesis](#)

Glycogen Synthase

Glycogen synthase catalyzes the addition of a **glucose** molecule (from **UDP-Glucose**) in an α 1,4 linkage to a growing glycogen chain. **Glycogen synthase** catalyzes the principal regulatory step of glycogen synthesis. Phosphorylation of the enzyme by cAMP-dependent Protein Kinase converts it from an independent, active form (called **glycogen synthase I**) to a dependent, less active form (called **glycogen synthase D**) whose activity is dependent on **glucose-6-phosphate**. cAMP-dependent protein kinase can phosphorylate **glycogen synthase I** directly, or it can phosphorylate SPK (also known as phosphorylase b kinase), which in turn is activated to phosphorylate **glycogen synthase I** (**Figures 16.11** and **16.12**). Phosphorylation converts glycogen synthase I to glycogen synthase D.

Conversion of the **D** form back to the **I** form requires action of the enzyme **phosphoprotein phosphatase I**. Glycogen synthase I is called the independent form of glycogen synthase, since it does not require glucose-6-phosphate for activity.

cAMP-dependent protein kinase requires **cAMP** for activity. Therefore, hormones, such as **epinephrine** and **glucagon**, which increase cAMP levels, tend to inactivate synthesis of glycogen due to conversion of **glycogen synthase I** to the dependent form (**glycogen synthase D**).

Conversely, hormones, such as **insulin**, which reduce cAMP levels and counteract the effects of cAMP-dependent protein kinase activity, stimulate dephosphorylation of **glycogen synthase D** to the independent form (**I**) and favor glycogen synthesis.

See also: [Glycogen Biosynthesis](#), [Kinase Cascade](#), [Glycogen](#), [SPK](#)

N-Carbamoyl-L-Aspartate (CAA)

Carbamoyl aspartate is a metabolite in the pathway of pyrimidine biosynthesis.

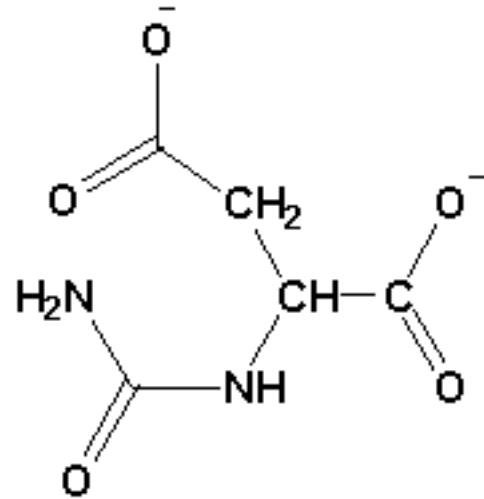

N-Carbamoyl-L-Aspartate (CAA)

1. Aspartate + Carbamoyl Phosphate \rightleftharpoons Carbamoyl aspartate (catalyzed by Aspartate Transcarbamoylase).
2. Carbamoyl Aspartate \rightleftharpoons Dihydroorotate + H₂O (catalyzed by Dihydroorotase)

See also: Figure 22.10, De Novo Pyrimidine Nucleotide Metabolism

INTERNET LINK: Pyrimidine Metabolism

Dihydroorotate

Dihydroorotate is an intermediate in *de novo* pyridine biosynthesis. It is synthesized from carbamoyl aspartate (as shown in the reaction that follows) and then converted to **orotate** (reaction 4, **Figure 22.10**).



See also: [De Novo Pyrimidine Nucleotide Metabolism](#)

INTERNET LINK: [Pyrimidine Metabolism](#)

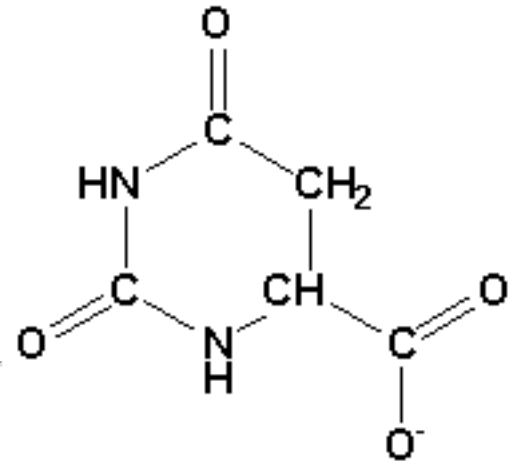

Dihydroorotate

Orotate

Orotate is an intermediate in *de novo* synthesis of pyrimidines. It is made by dehydrogenation of dihydroorotate in a reaction catalyzed by dihydroorotate dehydrogenase ([Figure 22.10](#)).

See also: [De Novo Pyrimidine Nucleotide Metabolism](#)

INTERNET LINK: [Pyrimidine Metabolism](#)

De Novo Pyrimidine Nucleotide Metabolism

Figure 22.10 illustrates the pathway for *de novo* pyrimidine biosynthesis. It differs from *de novo* purine synthesis in that the pyrimidine ring is synthesized separate from the ribose sugar (in purines, the ring is built upon the sugar - see **Figure 22.4**). In addition, *de novo* pyrimidine biosynthesis is not branched. Synthesis leads to UMP, from which CTP is ultimately made. By contrast, *de novo* purine biosynthesis branches after IMP is produced (**Figure 22.6**).

The first step in the pathway, formation of **carbamoyl aspartate** from **aspartate** and **carbamoyl phosphate**, is the primary regulatory point in the pathway. The enzyme, aspartate transcarbamoylase (**ATCase**) (see **here**), is activated by **ATP** and inhibited by **CTP**, which is the end product of the pathway. Another point of regulation is **CTP synthetase**, which is feedback inhibited by CTP and activated by **GTP**. In bacteria, synthesis of ATCase subunits is inhibited by high levels of **UTP**. The inverted regulatory effects of purine and pyrimidines in the pathway are yet another way cells maintain a proper balance of nucleotides.

In eukaryotes, enzymes 1-3 of **Figure 22.10** are all part of a single multifunctional polypeptide chain called CAD. In mammals, reactions 5 and 6 are catalyzed by a single protein called UMP synthase.

See also: [De novo Biosynthesis of Purine Nucleotides](#)

INTERNET LINK: [Pyrimidine Metabolism](#)

Figure 22.6: Pathways from inosinic acid to GMP and AMP.

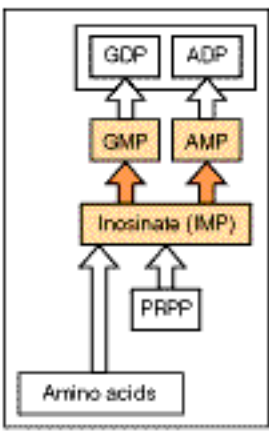
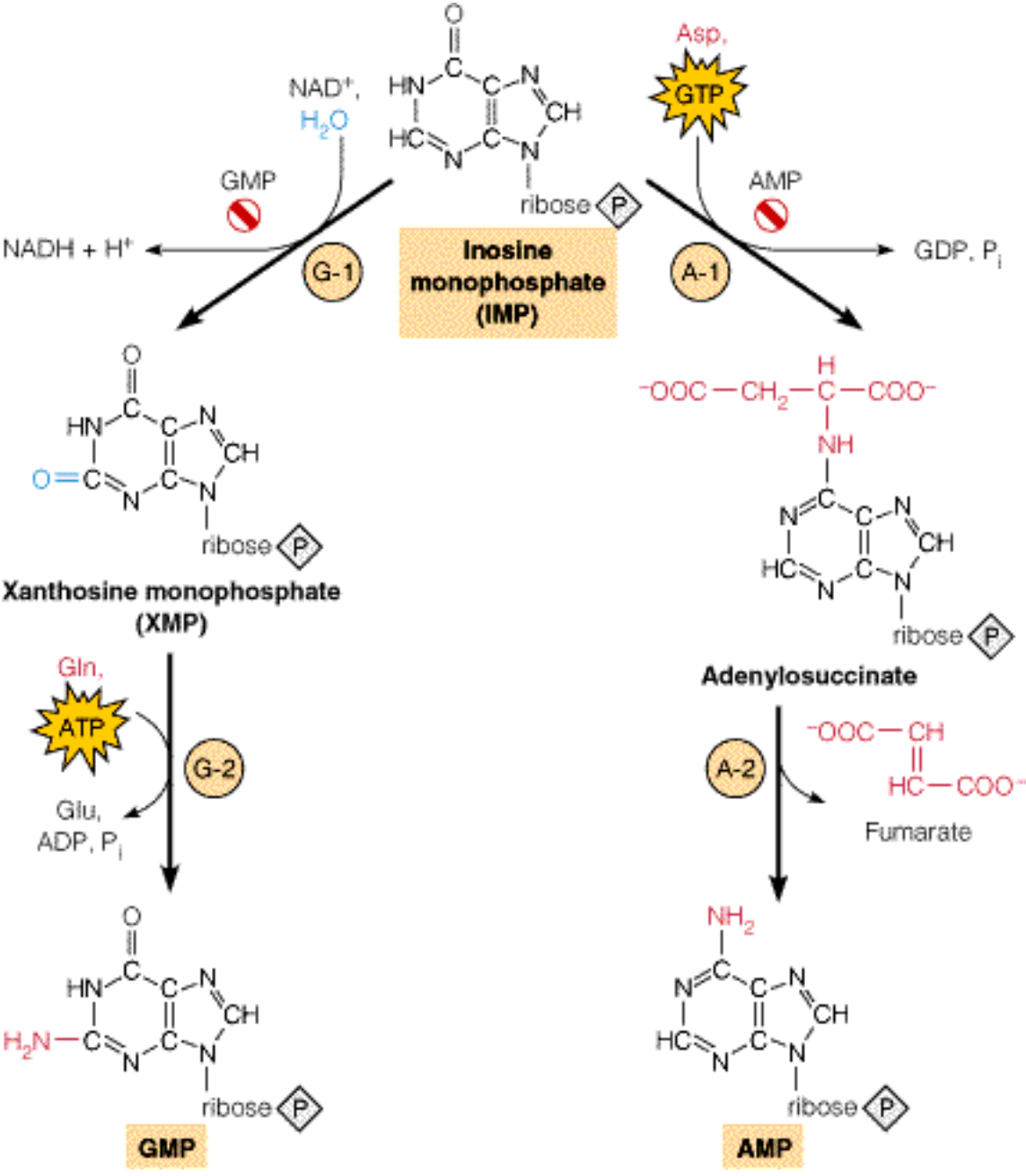

CTP Synthetase



CTP Synthetase is an enzyme catalyzing the reaction below:



This reaction is part of *de novo* pyrimidine synthesis.

See also: [De Novo Pyrimidine Nucleotide Metabolism](#)

De Novo Biosynthesis of Purine Nucleotides

Figure 22.4 summarizes the pathway leading from phosphoribosyl-1-pyrophosphate (**PRPP**) to **inosine 5'-monophosphate (IMP)**. **IMP**, also called **inosinic acid** is the first fully formed purine nucleotide. It contains **hypoxanthine** as its base.

Important points about the synthesis of purine nucleotides to the point of IMP:

1. *De novo* purine nucleotide synthesis proceeds by the synthesis of the purine base upon the ribose sugar moiety.
2. Addition of an amine group in the first reaction causes the **anomeric carbon** to flip from the α position in PRPP to the β position in 5-phosphoribosylamine (**PRA**). All nucleotides have **ribose/deoxyribose** in the β configuration.
3. Amine groups are donated by **glutamine** via **amidotransferase**-catalyzed reactions.
4. Single carbon units are added from **10-formyl-tetrahydrofolate** in transformylase-catalyzed reactions (**Figure 22.5**)
5. **Glycine** and **fumarate** molecules are used to build the ring structure.
6. The reaction pathway is regulated allosterically by AMP, ADP, GMP, and GDP, which all inhibit **PRPP amidotransferase**, the first enzyme in the pathway. In *E. coli*, synthesis of the genes for the pathway is controlled by the purR repressor protein, which is activated by binding **hypoxanthine** or **guanine**.

Multifunctional enzymes in vertebrate cells contain several of these activities in the same molecule.

Pathway from IMP to GMP and AMP:

Figure 22.6 shows that IMP is a branch point for the synthesis of guanosine monophosphate (**GMP**) or adenosine monophosphate (**AMP**). Note that the enzyme catalyzing the pathway to make AMP is inhibited by AMP and the enzyme catalyzing the pathway to make GMP is inhibited by GMP. Note, also, that energy requirements for the AMP pathway are met by **GTP** whereas energy requirements for the GMP pathway are met by **ATP**.

Cells exert a tremendous amount of control over the relative amounts of each nucleotide as demonstrated

by the *de novo* synthetic reactions and in conversions of ribonucleotides to deoxyribonucleotides.

Conversion of GMP and AMP to GTP and ATP:

GMP and AMP are converted to diphosphates (see [here](#)) in reactions catalyzed by [guanylate kinase](#) and [adenylate kinase](#), respectively. Conversion of nucleoside diphosphates to nucleoside triphosphates is catalyzed by [nucleoside diphosphate kinase](#) (see [here](#)). The reaction is reversible, thus providing a way to make both ATP and GTP. The enzyme is highly active, but has broad specificity for its phosphoryl group donor (nucleoside triphosphate) and receptor (nucleoside diphosphate).

See also: [The Importance of PRPP](#), [De Novo Pyrimidine Nucleotide Metabolism](#).

INTERNET LINKS:

1. [Purine Metabolism](#)
 2. [Purine and Pyrimidine Metabolism](#)
-

Inosine Monophosphate (IMP)

IMP is an intermediate in *de novo* biosynthesis of purine nucleotides ([Figure 22.4](#)) and is found in several purine nucleotide metabolic pathways.

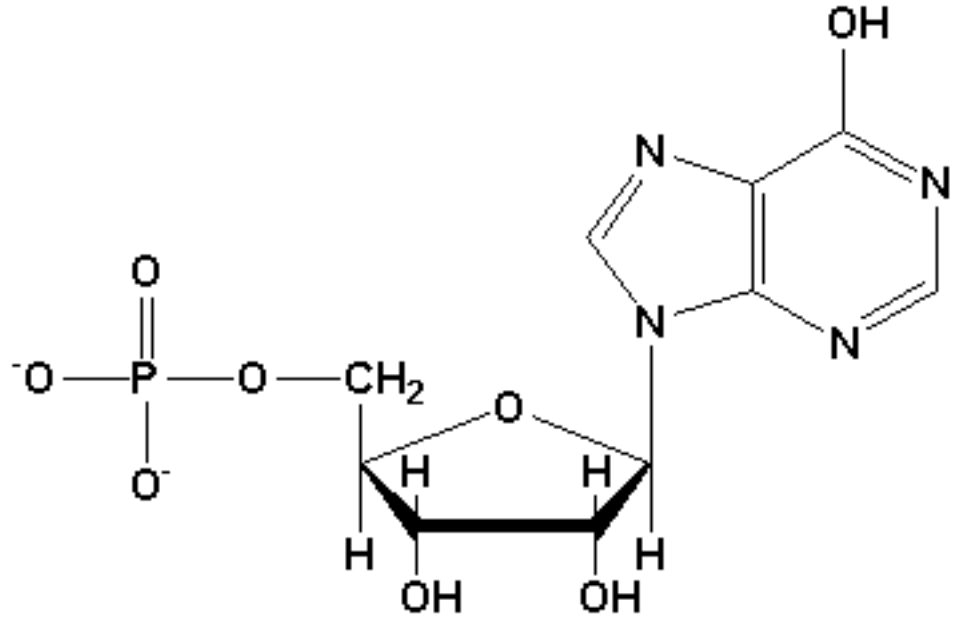

Inosine monophosphate (IMP)

IMP is a branch point between synthesis of [GMP](#) and [AMP](#) ([Figure 22.6](#)). **IMP** is acted upon by [adenylosuccinate synthetase](#) in AMP biosynthesis and by [IMP dehydrogenase](#) in GMP biosynthesis.

In purine catabolism, AMP can be made into **IMP** by action of the enzyme [AMP deaminase](#) ([Figure 22.7](#)).

IMP can also be made from [PRPP](#) and [hypoxanthine](#) by the enzyme [HGPRT](#) ([Figure 22.9](#)).

See also: [De Novo Biosynthesis of Purine Nucleotides](#), [Purine Degradation](#), [Salvage Routes to Deoxyribonucleotide Synthesis](#), [Nucleotides](#)

INTERNET LINKS:

1. [Purine Metabolism](#)
 2. [Purine and Pyrimidine Metabolism](#)
-

Cyclic Guanosine Monophosphate (cGMP)

cGMP is formed by action of the enzyme guanylate cyclase on GTP:



In smooth muscle, cGMP synthesis is stimulated by nitric oxide. In the eye, cGMP is broken down by a specific phosphodiesterase activated by the transducin-GTP complex. The product of action of the phosphodiesterase is GMP.

Cleavage of cGMP stimulates intracellular reactions that generate a visual signal to the brain. Thus, the stimulated hydrolysis of cGMP is the visual analog of the stimulated synthesis of cAMP in β -adrenergic responses.

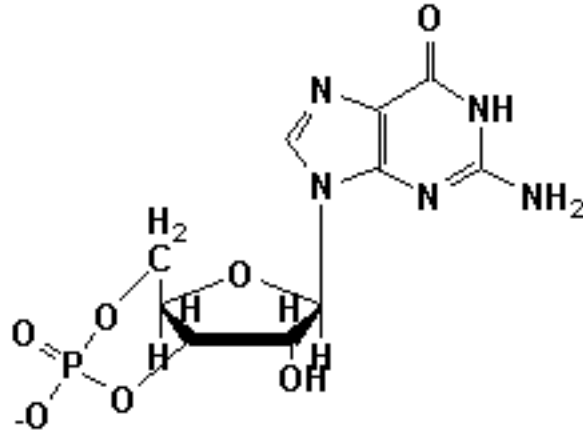

Cyclic guanosine monophosphate (cGMP)

See also: GMP, GTP, cAMP, Actions of Nitric Oxide, Transducin, G Proteins in Vision, Second Messenger Systems, Chemistry of Photoreception

Guanylate Cyclase



Guanylate cyclase is an enzyme that catalyzes the reaction:



where cGMP is cyclic GMP, an important second messenger in the cell, particularly for vision (see here).

See also: Actions of Nitric Oxide, Receptors with Protein Kinase Activity

Second Messenger Systems

1. **Cyclic AMP (cAMP)** - Many signal transduction events involve the linked actions of a cell surface receptor, G protein, and adenylate cyclase. These events either stimulate or inhibit the synthesis of the second messenger, **cAMP**, inside the cell. Many intracellular processes are controlled, in turn, by the level of that second messenger. **cAMP** can affect transcription by binding to a protein called CREB (**cAMP** response element binding protein), and the resultant complex controls transcription of genes, including those encoding particular receptors.
2. **Cyclic GMP (cGMP)** - **Nitric oxide** stimulates the synthesis of **cGMP** (see [here](#)). Many cells contain a **cGMP**-stimulated protein kinase that, like the **cAMP**-activated enzyme, contains both catalytic and regulatory subunits.
3. **Calcium** - **Calcium** ion can be considered a second messenger. Many cells respond to extracellular stimuli by altering their intracellular calcium concentration, which in turn effects biochemical changes either by itself or through its interaction with **calmodulin**. **Calcium** levels themselves are controlled in large part by second messengers, including **cAMP**. Because **cAMP** regulates calcium influx, **calcium** ion may be more of a third messenger than a second messenger.
4. **Phosphoinositide/Diacylglycerol** - Cytosolic calcium ion levels also can be increased by release from intracellular calcium stores. Access to these intracellular stores is controlled by the **phosphoinositide** system. In the phosphoinositide system, hormonal stimulus activates a reaction that generates two second messengers. A specific lipid in the phosphoinositide family, **phosphatidylinositol 4,5-bisphosphate** (PIP₂), is a membrane-associated storage form for two second messengers. As shown in [Figure 23.14](#), steps in the process include the following:
 - a. An agonist binds to a receptor.
 - b. Receptor binding stimulates a G protein (see [here](#)) to bind **GTP**, just as occurs during the activation of **adenylate cyclase**.
 - c. The G protein activates **phospholipase C**, which in turn cleaves **PIP₂** to yield two products, namely sn-1,2-diacylglycerol (**DAG**) and inositol 1,4,5-trisphosphate (**InsP₃**) (see [here](#)). Both of these products act as second messengers. Therefore, the cleavage of PIP₂ by **phospholipase C** is the functional equivalent of the synthesis of **cAMP** by adenylate cyclase.
 - d. Inositol trisphosphate stimulates the release of calcium from its intracellular stores in the endoplasmic reticulum . The release of calcium ion has various effects on intracellular metabolism, as noted earlier, but it also contributes to the second-messenger role of

diacylglycerol.

e. Diacylglycerol stimulates membrane-bound [protein kinase C](#). In order for it to be active, protein kinase C requires calcium ion (hence the "C" designation) and a phospholipid (specifically, phosphatidylserine). Diacylglycerol stimulates protein kinase C activity by greatly increasing the affinity of the enzyme for calcium ions. The requirement is specific for the sn-1,2-DAG; neither the 1,3- nor the 2,3-isomer is active.

f. Protein kinase C phosphorylates specific serine and threonine residues in target proteins. As with cAMP-stimulated protein kinase, the specific cellular responses to protein kinase C activation depend on the ensemble of target proteins that become phosphorylated in a given cell. Known target proteins include [calmodulin](#), the insulin receptor, the β -adrenergic receptor (see [here](#)), the glucose transporter, [HMG-CoA reductase](#), [cytochrome P450](#), and tyrosine hydroxylase.

After its release from PIP₂, three sequential hydrolytic steps convert inositol trisphosphate back to inositol, which is then reincorporated into [phosphatidylinositol](#), to regenerate PIP and PIP₂. The last hydrolytic step, the hydrolysis of inositol monophosphate to inositol, is specifically inhibited by lithium ion. This blockage inhibits the resynthesis of InsP₃ by depleting the cell of inositol. Given that the phosphoinositide messenger system is widely used in nervous tissue, the action of lithium ion may be related to its efficacy in the treatment of manic-depressive disorder.

Some of the processes controlled by the phosphoinositide system are listed in [Table 23.5](#).

[Phospholipases](#) other than phospholipase C are also stimulated by G proteins. [Arachidonic acid](#), released from phosphatidylcholine, is the major metabolic precursor to [eicosanoids](#). [Phospholipase A₂](#), which releases [fatty acids](#) from [glycerophospholipids](#), also interacts with G proteins, and phospholipase D (see [here](#)) is thought to participate in signal transduction via diacylglycerol formation. In addition, some phospholipases are controlled by Ca²⁺.

See also: [Kinase Cascade](#), [G Proteins and Signal Transduction](#), [G Proteins in Vision](#), [Kinase Cascade in Fat Mobilization](#) (from Chapter 18)

INTERNET LINKS:

1. [Neurochemistry and Second Messenger Functions](#)
2. [Second Messenger Cascades](#)

Nitric Oxide

Nitric Oxide was originally identified as a signal-transducing agent in vasodilation of endothelial vascular cells and underlying smooth muscle. A variety of signals that decrease blood pressure and inhibit platelet aggregation use **nitric oxide** as an intermediary. The **nitric oxide synthase** in endothelial vascular cells is acutely sensitive to calcium ion concentration; activation of the enzyme by Ca^{2+} causes **nitric oxide** accumulation. Because **nitric oxide** is a gas, it can diffuse rapidly into neighboring cells and control their metabolism, primarily by stimulating **cGMP** synthesis. **Nitric oxide** is unstable, with a chemical half-life of 1 to 5 seconds, so its actions are short-lived. Studies of intracellular localization of nitric oxide synthase and of nitric oxide synthase inhibitors have identified additional roles for **nitric oxide** as diverse as neurotransmission in the central nervous system and stimulation of erection of the penis.

See also: [Actions of Nitric Oxide](#)

INTERNET LINK: [The Nitric Oxide Home Page](#)

Nitric Oxide Synthase

The amino acid [Arginine](#) is a precursor to a novel second messenger and neurotransmitter, which is a gas, [nitric oxide](#). Nitric oxide is produced from [arginine](#) in an unusual five-electron oxidation that also yields [citrulline](#) (see [Figure 21.3](#)). The enzyme catalyzing the reaction, **nitric oxide synthase**, contains bound [FMN](#), [FAD](#), non-heme iron, and [tetrahydrobiopterin](#).

See also: [Actions of Nitric Oxide](#), [cGMP](#)

INTERNET LINK: [The Nitric Oxide Home Page](#)

Figure 21.3: Biosynthesis of creatine phosphate and nitric oxide from arginine.

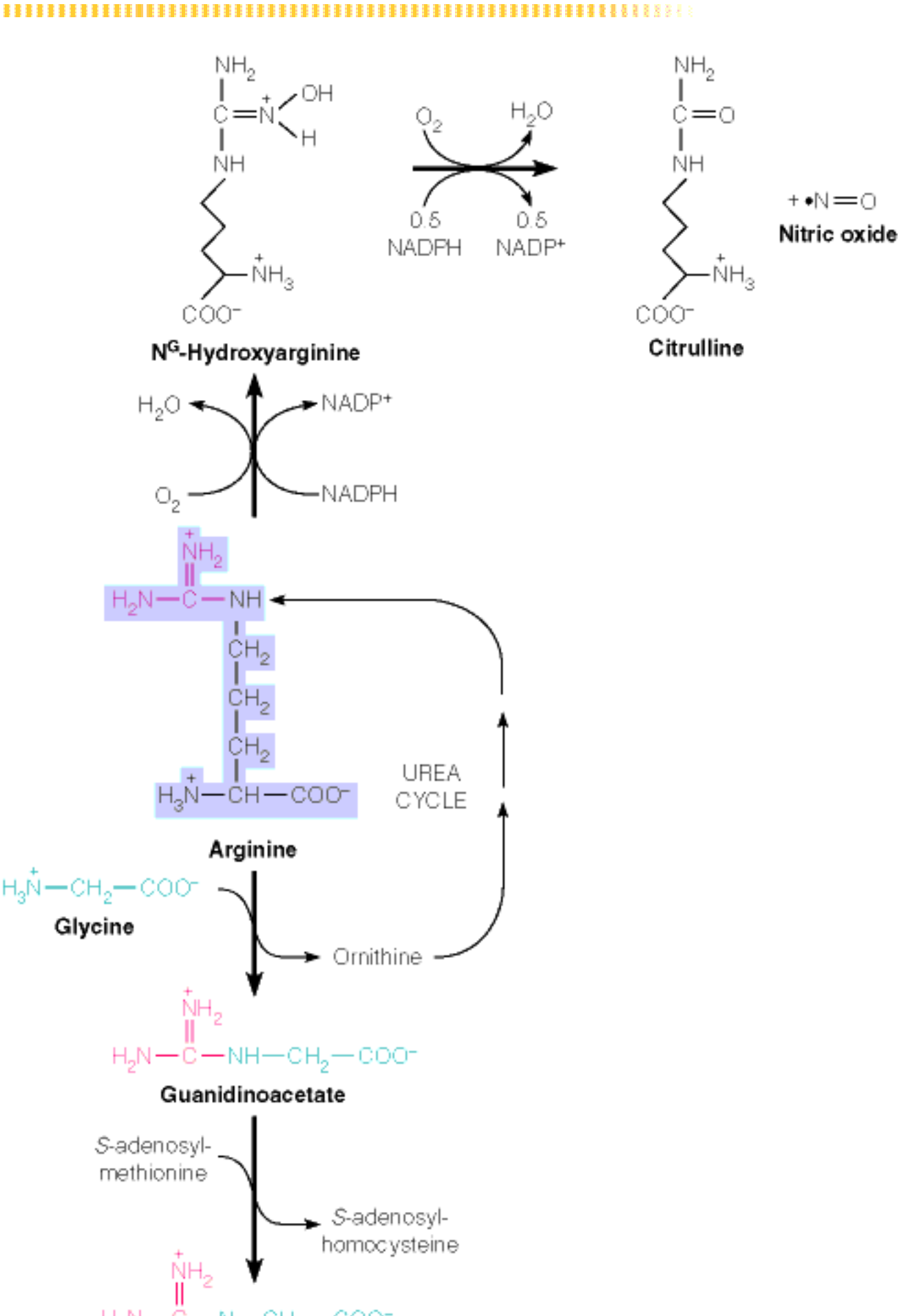

S-adenosyl-homocysteine

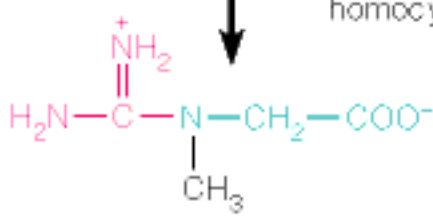

Creatine



Creatine kinase
ADP

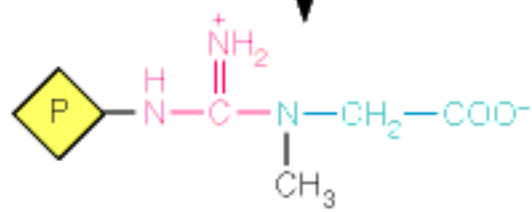

Creatine phosphate

Flavin Mononucleotide (FMN)

FMN, also known as riboflavin phosphate, is a flavin containing electron carrier in the cell ([Figure 14.7](#)). It participates in oxidation/reduction reactions and, like FAD, differs from the nicotinamide coenzymes (NAD^+ and NADP^+) in being able to accept electrons either singly or in pairs ([Figure 14.8](#)). NAD^+ and NADP^+ can only accept electrons in pairs.

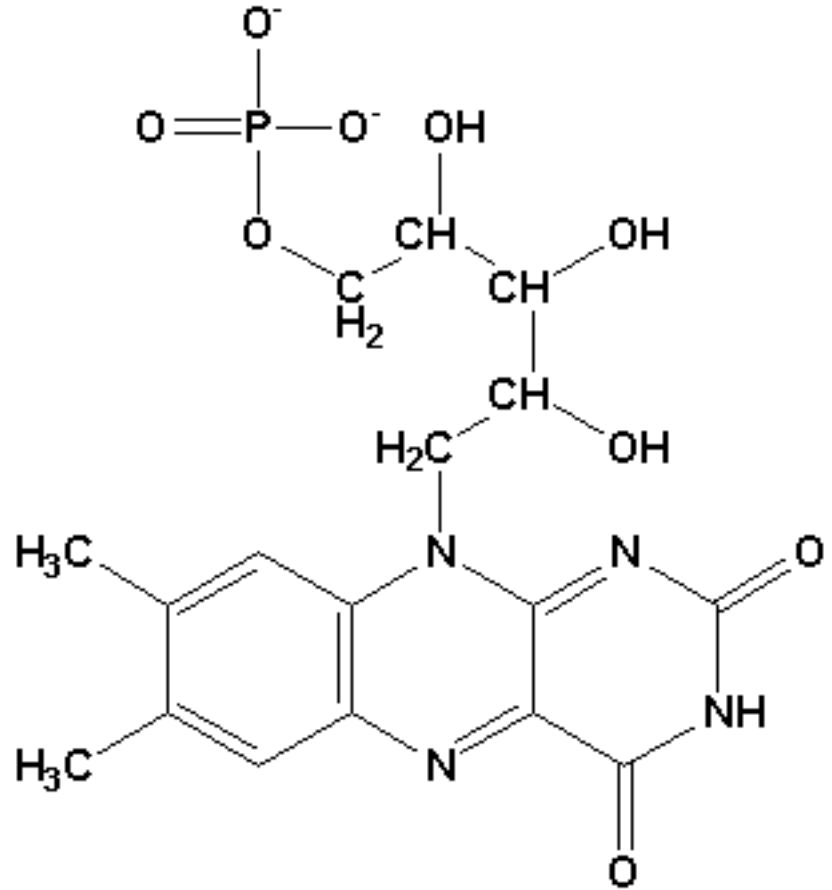

Flavin Mononucleotide (FMN)

See also: [FMNH₂](#), [FADH₂](#), [NAD⁺](#), [NADP⁺](#), [FAD](#), [Riboflavin](#)

Figure 14.7: Structures of riboflavin and the flavin coenzymes.

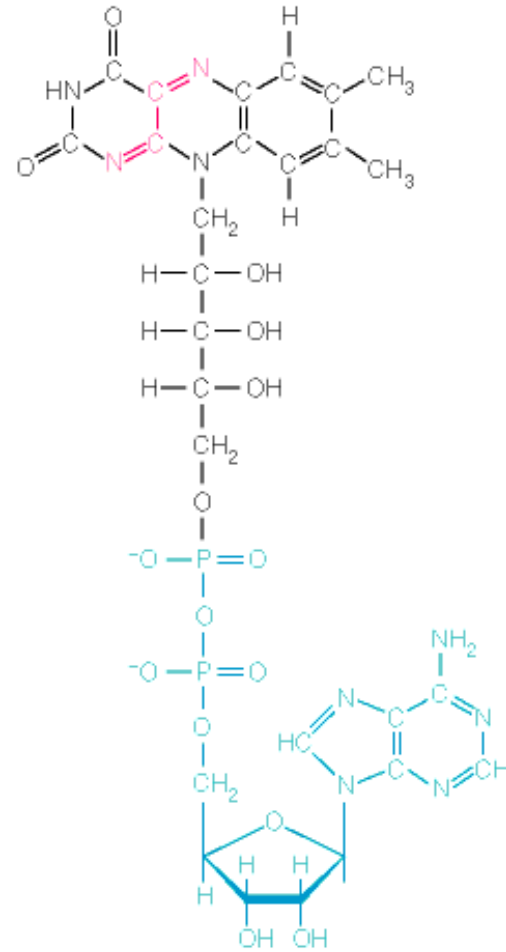
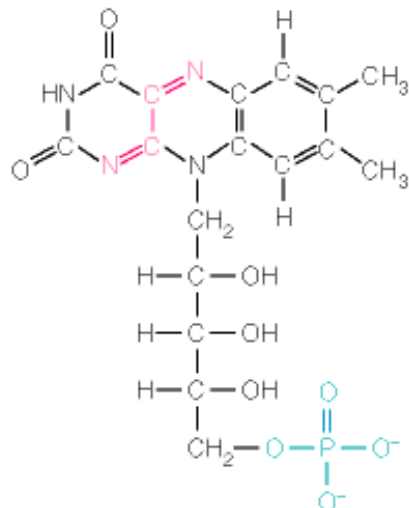
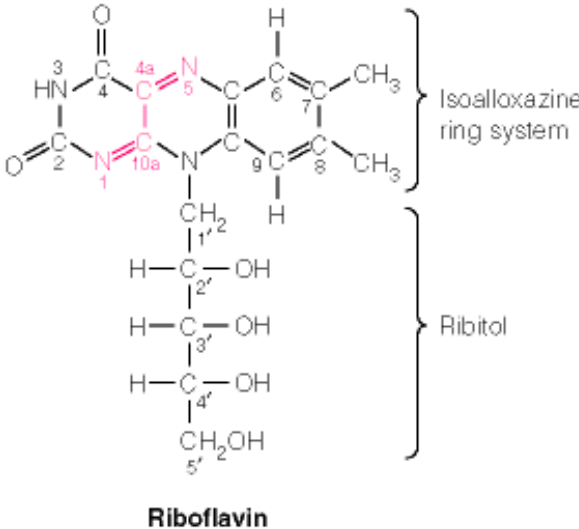
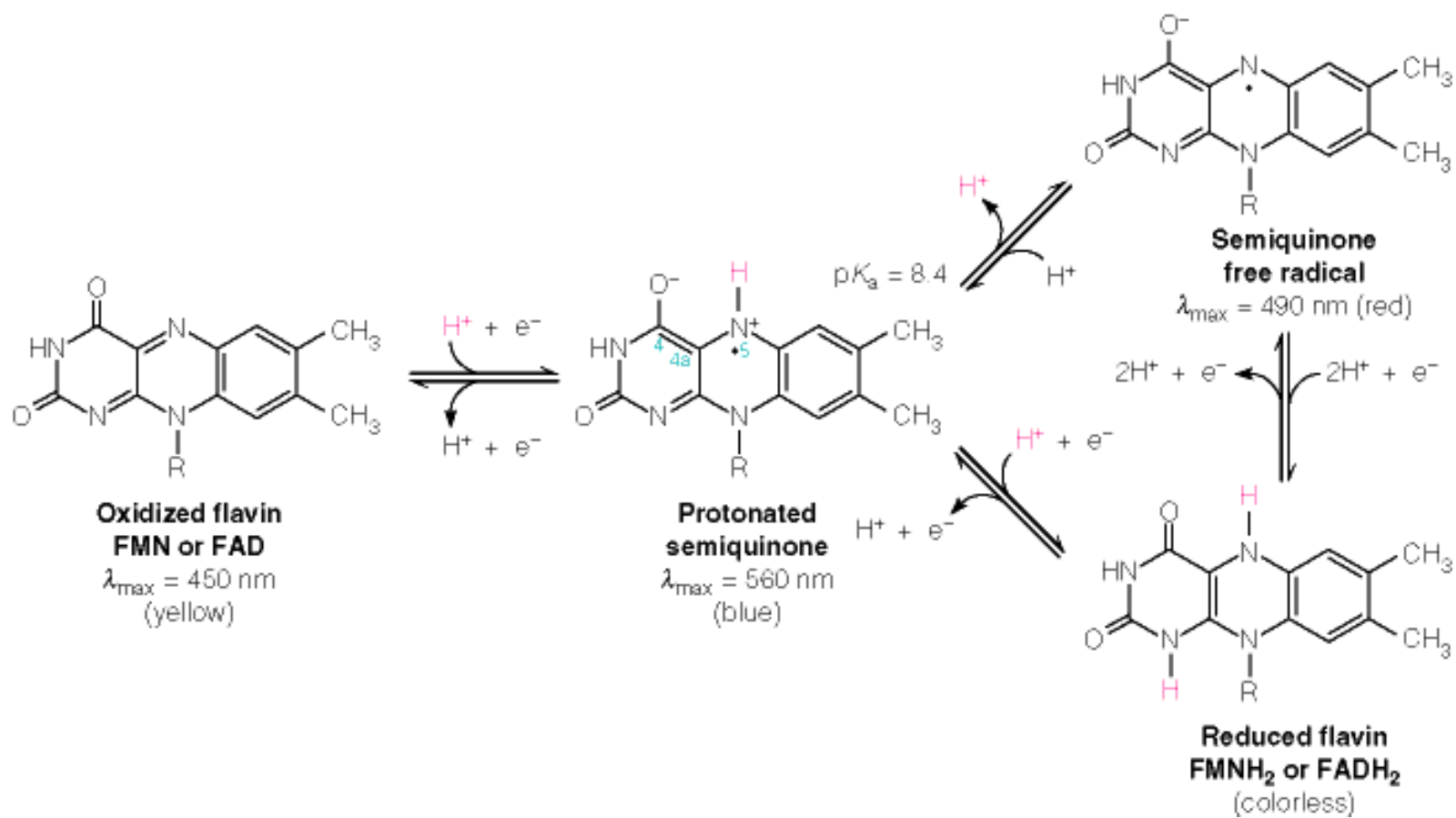
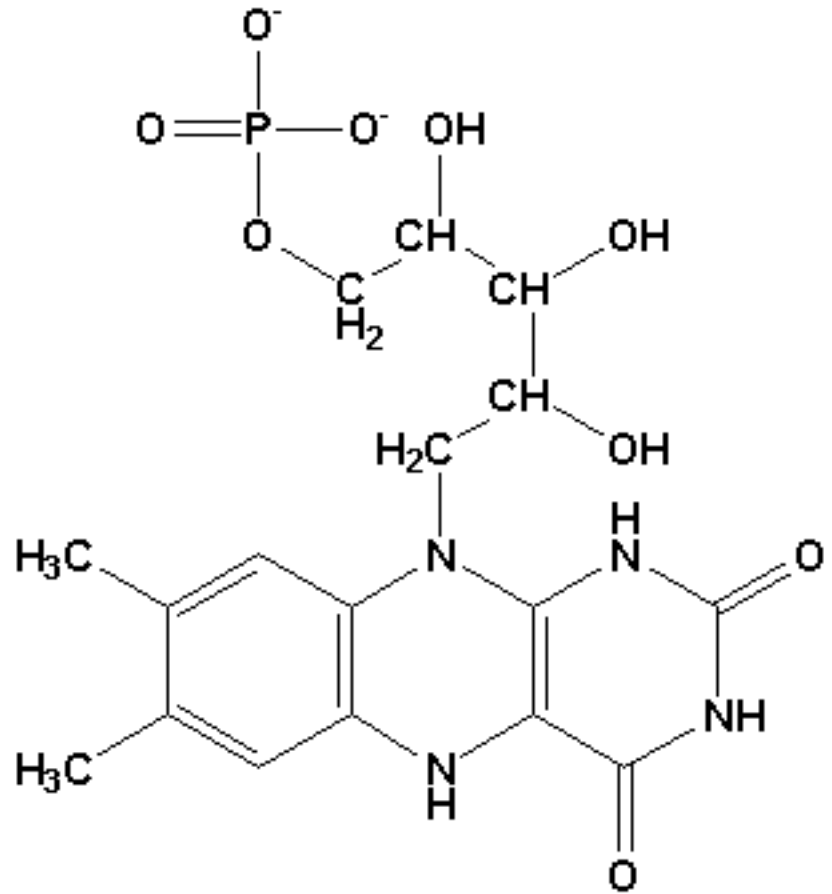

Figure 14.8: Oxidation and reduction reactions involving flavin coenzymes.



Flavin Mononucleotide, Reduced (FMNH₂)

FMNH₂ is the reduced form of [FMN](#) ([Figure 14.7](#)).



**Flavin Mononucleotide reduced
(FMNH₂)**

See also: [NAD⁺](#), [NADP⁺](#), [FAD](#), [Riboflavin](#)

Riboflavin (Vitamin B)

Riboflavin, also known as **vitamin B2**, is a component of the flavin coenzymes, FAD and FMN ([Figure 14.7](#)). It is composed of an isoalloxazine ring system linked to ribitol. The ability of the ring system of **riboflavin** to exist as a semiquinone allows the flavin coenzymes to accept electrons either singly or in pairs.

See also: [FAD](#), [FMN](#)

INTERNET LINK: [Riboflavin Metabolism](#)

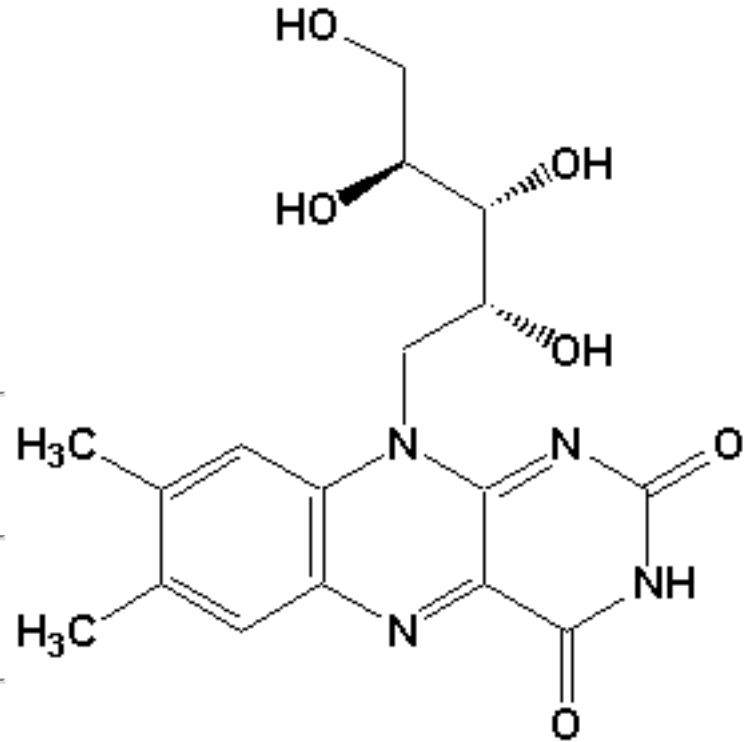

Vitamin B2 (Riboflavin)

Tetrahydrobiopterin

Tetrahydrobiopterin is the reduced form of dihydrobiopterin, an electron carrier in tyrosine biosynthesis ([Figure 21.18](#)). Tyrosine is only aromatic amino acid made in animals. The reaction is catalyzed by [phenylalanine hydroxylase](#).

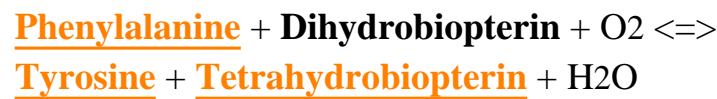

Tetrahydrobiopterin is also part of the [nitric oxide synthase](#) enzyme.

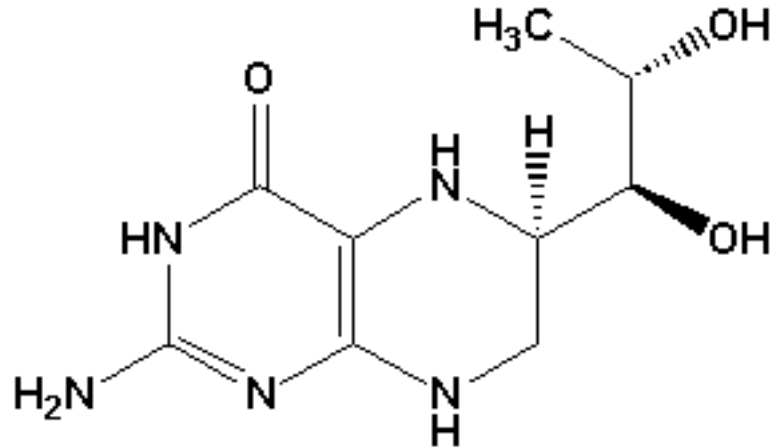

Tetrahydrobiopterin

See also: [Phenylalanine Hydroxylase](#), [Aromatic Amino Acid Utilization](#),

INTERNET LINKS:

1. [Phenylalanine, Tyrosine, and Tryptophan Biosynthesis](#)
 2. [Tyrosine Metabolism](#)
 3. [The Nitric Oxide Home Page](#)
-

Figure 21.18: The phenylalanine hydroxylase and dihydropteridine reductase reactions.

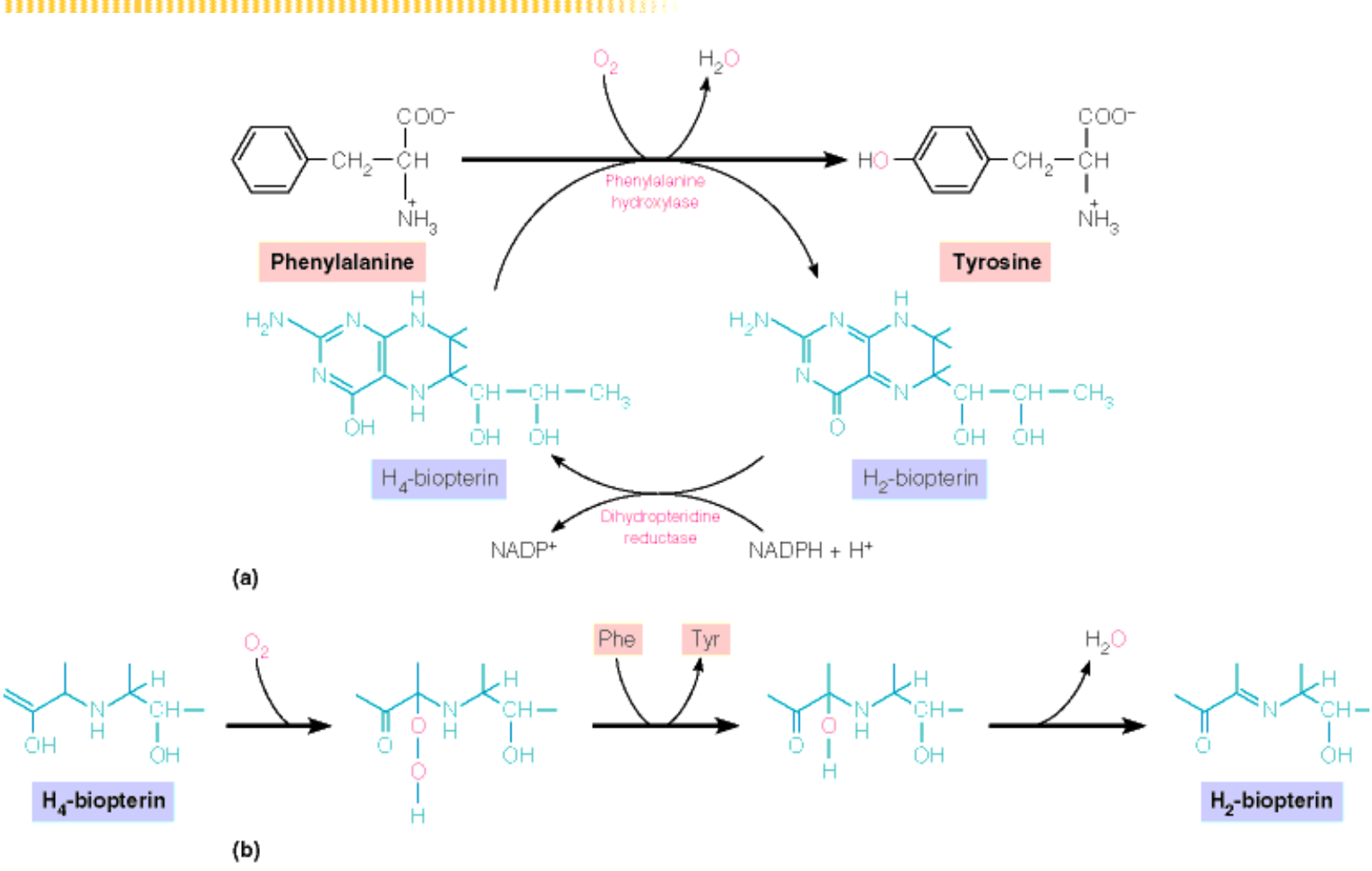

Phenylalanine Hydroxylase

Tyrosine is the only aromatic amino acid made in animals. This occurs in the reaction catalyzed by **phenylalanine hydroxylase**, as follows ([Figure 21.18](#)):

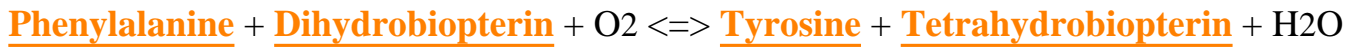

Deficiency of **phenylalanine hydroxylase** is responsible for phenylketonuria (PKU), an autosomal recessive disease that results in production of too much phenylalanine, due to the block in synthesis of tyrosine.

See also: [Aromatic Amino Acid Utilization](#)

INTERNET LINKS:

1. [Phenylalanine, Tyrosine, and Tryptophan Biosynthesis](#)
 2. [Tyrosine Metabolism](#)
 3. [Phenylalanine Metabolism](#)
 4. [Tryptophan Metabolism](#)
-

Phenylalanine

Phenylalanine is an α **amino acid** found in proteins. In mammals, **phenylalanine** is an essential amino acid, meaning it must be present in the diet.

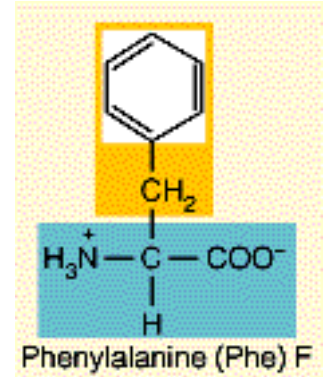

Phenylalanine's phenyl side chain classifies it as an aromatic amino acid. The aromatic amino acids, like most compounds carrying conjugated rings, exhibit strong absorption of light in the near-ultraviolet region of the spectrum (**Figure 5.6**). This absorption is frequently used for the analytical detection of proteins.

Phenylalanine, together with the aliphatic amino acids **valine**, **leucine**, and **isoleucine**, are the most hydrophobic amino acids. The more hydrophobic amino acids are usually found in the interior of a protein molecule, where they are shielded from water.

Phenylalanine is part of the synthetic metabolic pathway in making **alkaloids**.

P>

One Letter Code	Three Letter Code	Molecular Wt. (Daltons)	Genetic Code Codons
F	PHE	147.18	UUU, UUC

See also: [Table 5.1, Genetic Code](#), [Metabolism of Aromatic Amino Acids and Histidine](#), [Essential Amino Acids](#)

INTERNET LINK: [Phenylalanine Metabolism](#)

Alkaloids

Alkaloids are a class of about 3000 nitrogenous compounds made in plants. They include substances, such as morphine (a narcotic) and colchicine (microtubule assembly inhibitor). Many of these substances have potent physiological effects in animals, but their function in plant metabolism is not well understood. Many **alkaloids** are derived from the aromatic amino acids tyrosine and phenylalanine.

See also: [Tyrosine](#), [Phenylalanine](#)

INTERNET LINKS:

1. [Alkaloid Biosynthesis I](#)
 2. [Alkaloid Biosynthesis II](#)
-

Metabolism of Aromatic Amino Acids and Histidine

The biosynthesis of heterocyclic and/or aromatic rings from noncyclic precursors requires complex chemical reactions. Most of these reactions (except the hydroxylation of phenylalanine to tyrosine) have been lost through evolution in animal metabolism.

Figure 21.12 provides an overview of the biosynthesis of aromatic amino acids and histidine. Note that the aromatic amino acids are involved in pathways for the synthesis of lignin (a major constituent of woody tissue) and auxins (a class of plant hormones).

Note also that a key intermediate in the synthesis of virtually all aromatic compounds in the cells is **shikimic acid**. These include **phenylalanine**, **tyrosine**, **tryptophan**, **p-aminobenzoic acid**, and **p-hydroxybenzoic acid**. The precursors to shikimic acid, however, are **erythrose-4-phosphate** and **phosphoenolpyruvate** (**Figure 21.13**). In fact, all of the carbons in phenylalanine and tyrosine are derived from these two compounds.

Besides showing the unbranched pathway from erythrose-4-phosphate and phosphoenolpyruvate to shikimic acid, **Figure 21.13** also shows the sequence of reactions from shikimic acid to **chorismate**, the first major branch point in the synthesis of the aromatic amino acids and histidine. The sixth reaction of the shikimic acid pathway is inhibited specifically by glyphosate (see **here**), which is the active ingredient in the broad spectrum herbicide known as Roundup.

Diverging pathways from chorismate to the five aromatic compounds above are shown schematically in **Figure 21.12** and in detail in **Figure 21.14**. The structure of the last enzyme in the synthesis of tryptophan, **tryptophan synthase**, consists of an $\alpha_2\beta_2$ dimer in which the separate subunits apparently catalyze the reactions (see **here**) in the enzyme and actually transfers the indol product through a tunnel in the interior part of the molecule. A schematic depiction of the tryptophan synthase reactions is shown in **Figure 21.16**.

See also: **[Biosynthesis of Histidine / Ames Test](#)**, **[Aromatic Amino Acid Utilization](#)**

INTERNET LINKS:

1. **[Phenylalanine, Tyrosine, and Tryptophan Biosynthesis](#)**
2. **[Tyrosine Metabolism](#)**

3. Phenylalanine Metabolism

4. Tryptophan Metabolism

5. Histidine Metabolism

Figure 21.12: Overview of the biosynthesis of aromatic amino acids and histidine.

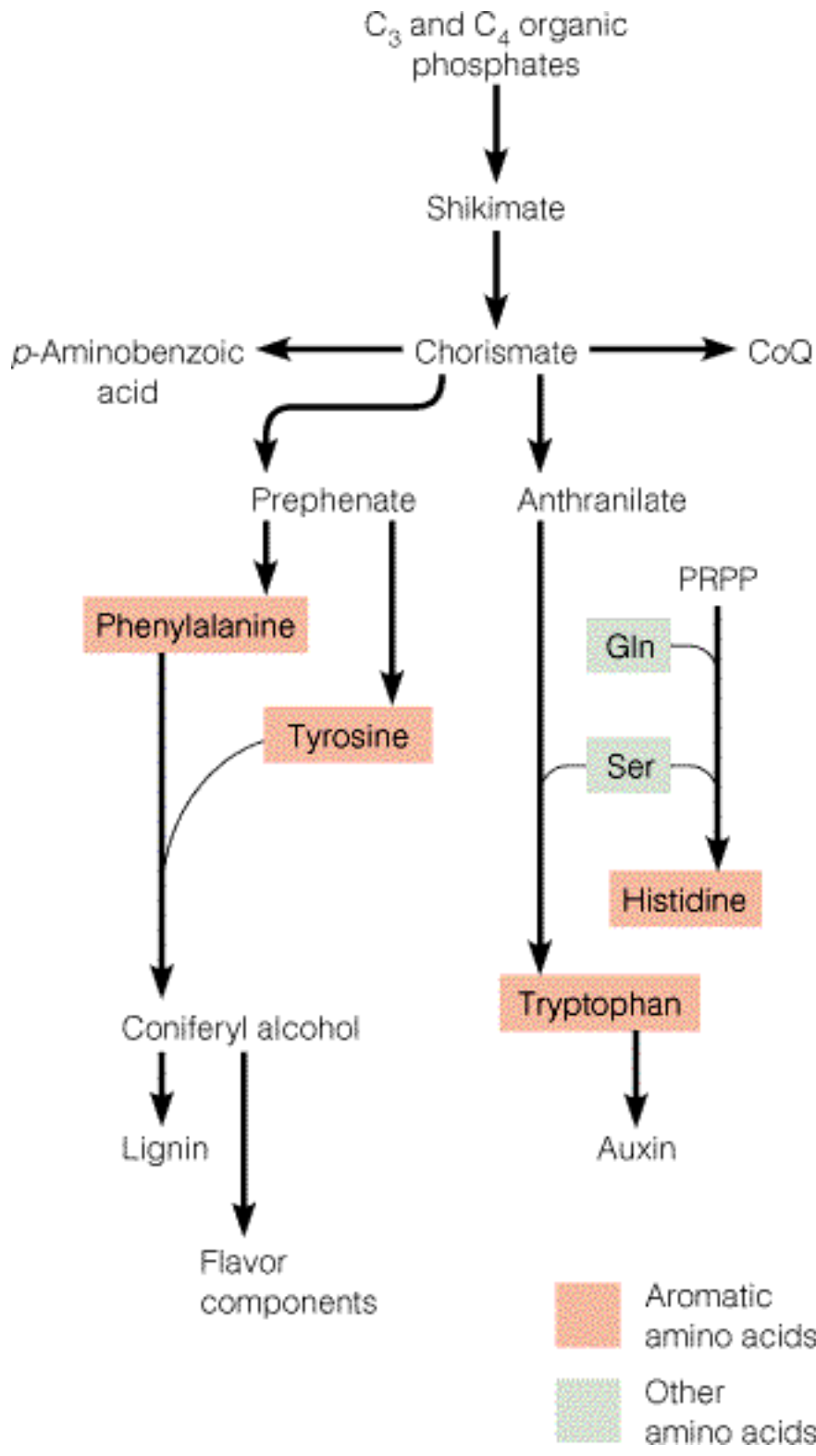

Shikimic Acid

A key intermediate in synthesis of virtually all aromatic compounds in the cells is **shikimic acid**. These include [phenylalanine](#), [tyrosine](#), [tryptophan](#), [p-aminobenzoic acid](#), and [p-hydroxybenzoic acid](#).

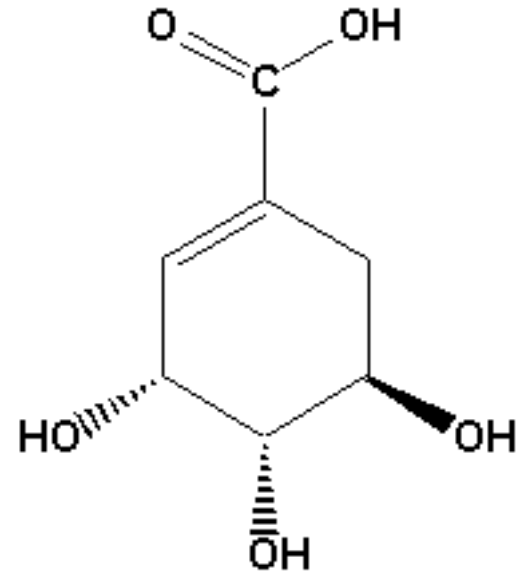

Shikimic Acid

The unbranched pathways from [erythrose-4-phosphate](#) and [phosphoenolpyruvate](#) through **shikimic acid** to [chorismate](#) is shown in [Figure 21.13](#). The sixth reaction of the **shikimic acid pathway** is inhibited specifically by [glyphosate](#), which is the active ingredient in the broad spectrum herbicide known as RoundupTM.

See also: [Metabolism of Aromatic Amino Acids and Histidine](#)

INTERNET LINKS:

1. [Phenylalanine, Tyrosine, and Tryptophan Biosynthesis](#)
 2. [Tyrosine Metabolism](#)
 3. [Phenylalanine Metabolism](#)
 4. [Tryptophan Metabolism](#)
 5. [Histidine Metabolism](#)
-

p-Aminobenzoic Acid

Figure 21.12 provides an overview of the biosynthesis of aromatic amino acids and **histidine**. All of the carbons in **phenylalanine** and **tyrosine** are derived from **erythrose-4-phosphate** and **phosphoenolpyruvate**. A key intermediate in synthesis of virtually all aromatic compounds (including **p-aminobenzoic acid**) in plant and bacterial cells is **shikimic acid**. Shikimic acid gives rise to **chorismate** (**Figure 21.13**), which is a precursor of **p-aminobenzoic acid** (**Figure 21.14**).

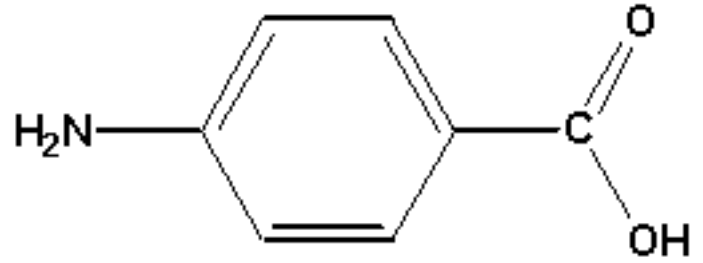

p-Aminobenzoic Acid (PABA)

p-Aminobenzoic acid is a component of **folate**.

See also: **Metabolism of Aromatic Amino Acids and Histidine**

Erythrose-4-Phosphate

Erythrose-4-phosphate (E4P) is an intermediate of the pentose phosphate pathway. It also is an intermediate in the Calvin cycle (photosynthesis). **Erythrose-4-phosphate** is produced by action of the enzyme transaldolase in the reaction below:

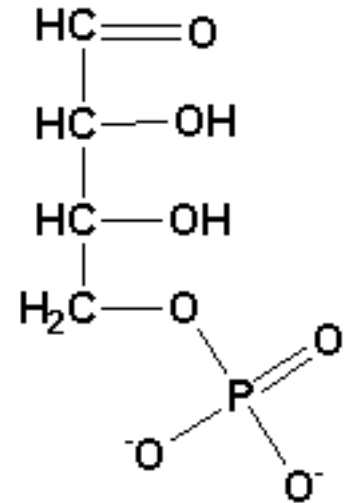

Erythrose-4-phosphate



In addition, **erythrose-4-phosphate** is involved in the biosynthesis of aromatic amino acids. All of the carbons in phenylalanine and tyrosine are derived from **erythrose-4-phosphate** and phosphoenolpyruvate.

See also: [Pentose Phosphate Pathway](#), [PPP Intermediates](#), [Transaldolase](#), [Calvin Cycle](#), [Metabolism of Aromatic Amino Acids and Histidine](#)

INTERNET LINKS:

1. [Pentose Phosphate Pathway](#)
 2. [CO₂ Fixation](#)
-

Transaldolase

Transaldolase is an enzyme of the pentose phosphate pathway catalyzing the reaction below:



See also: [Pentose Phosphate Pathway \(PPP\)](#), [PPP Enzymes](#)

INTERNET LINK: [Pentose Phosphate Pathway](#)

Sedoheptulose-7-Phosphate

Sedoheptulose-7-phosphate is an intermediate in the pentose phosphate pathway produced by **transketolase**-catalyzed rearrangements of xylulose-5-phosphate and ribose-5-phosphate to form glyceraldehyde-3-phosphate and **sedoheptulose-7-phosphate**.

It is also an intermediate in the **Calvin cycle**, resulting from the action of **sedoheptulose-1,7-bisphosphatase** on sedoheptulose-1,7-bisphosphate.

See also: [Pentose Phosphate Pathway](#), [Pentose Phosphate Pathway Intermediates](#)

INTERNET LINKS:

1. [Pentose Phosphate Pathway](#)
 2. [Carbon Fixation](#)
-

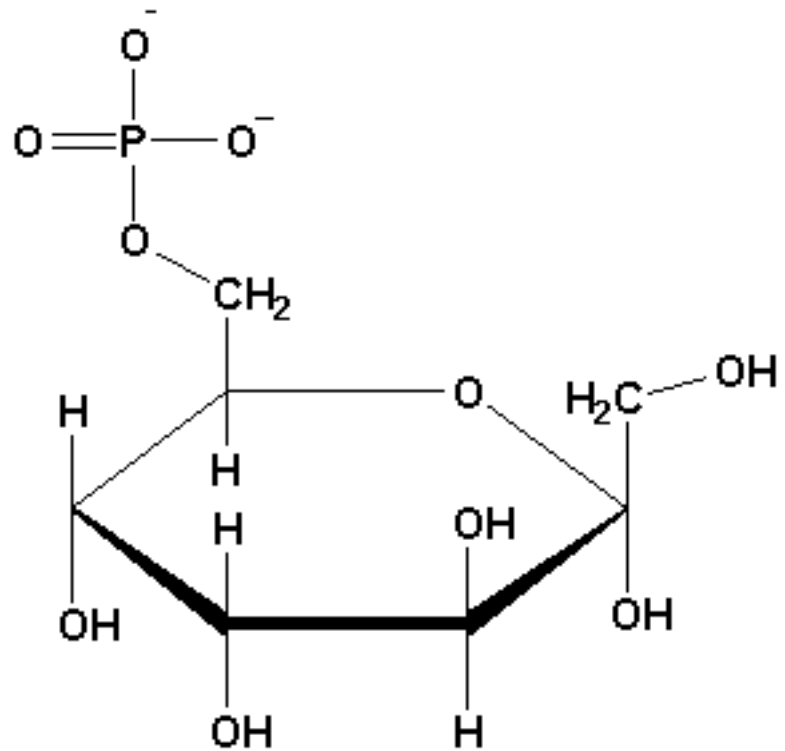

Sedoheptulose-7-phosphate

Transketolase

Transketolase is an enzyme of the pentose phosphate pathway catalyzing the reactions below:



and



In the Calvin cycle, **transketolase** also catalyzes the reversals of these reactions above.

The reactions involve transfer of a two carbon acetaldehyde fragment from xylulose-5-phosphate to an acceptor sugar phosphate. The reactions require thiamine pyrophosphate (TPP) as a cofactor, with the two-carbon fragment bound transiently to carbon 2 of the thiazole ring of TPP.

See also: Pentose Phosphate Pathway (PPP), PPP Enzymes, Transaldolase

INTERNET LINKS:

1. Pentose Phosphate Pathway
 2. CO2 Fixation
-

Xylulose-5-Phosphate

Xylulose-5-phosphate is an intermediate of the [pentose phosphate pathway](#) produced from ribulose-5-phosphate in the reaction catalyzed by [phosphopentose epimerase](#) or from glyceraldehyde-3-phosphate and sedoheptulose-7-phosphate in the reaction catalyzed by transketolase.

Xylulose-5-phosphate is also produced in the [Calvin cycle](#) by a reversal of the pentose phosphate pathway reaction catalyzed by [transketolase](#).

See also: [PPP Intermediates](#), [Arabinose Operon](#)

INTERNET LINKS:

1. [Pentose Phosphate Pathway](#)
 2. [CO2 Fixation](#)
-

Phosphopentose Epimerase

Phosphopentose epimerase is an enzyme of the pentose phosphate pathway that catalyzes the reaction below:

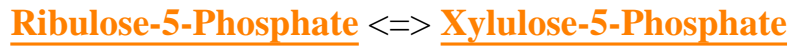

See also: [Pentose Phosphate Pathway](#), [Pentose Phosphate Pathway Enzyme](#)

INTERNET LINK: [Pentose Phosphate Pathway](#)

Ribulose-5-Phosphate

Ribulose-5-phosphate is a [pentose phosphate pathway intermediates](#) produced by 6-phosphogluconate dehydrogenase catalyzed oxidation of 6-phosphogluconolactone.

It is also an intermediate in the [Calvin cycle](#), serving as the precursor to [ribulose-1,5-bisphosphate](#).

See also: [Pentose Phosphate Pathway](#), [6-Phosphogluconate Dehydrogenase](#)

INTERNET LINKS:

1. [Pentose Phosphate Pathway](#)
 2. [Carbon Fixation](#)
-

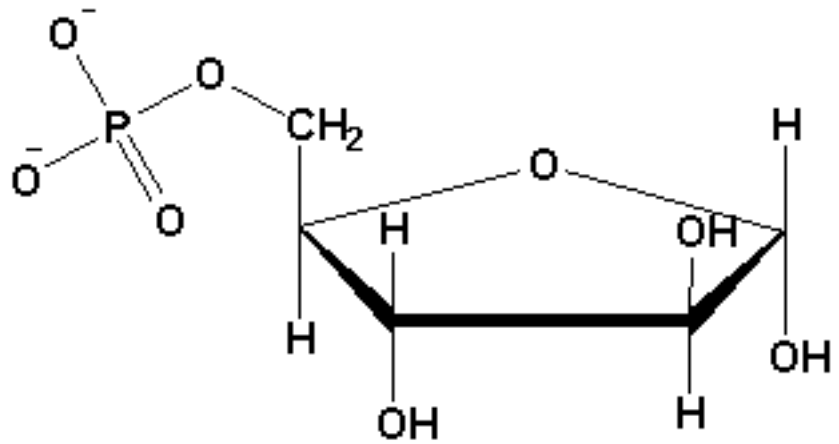

Ribulose-5-phosphate

Intermediates of the Pentose Phosphate Pathway

The molecular intermediates of the **pentose phosphate pathway** are listed below:

[6-Phosphogluconolactone](#)

[6-Phosphogluconate](#)

[Ribulose-5-Phosphate](#)

[Ribose-5-Phosphate](#)

[Xylulose-5-Phosphate](#)

[Glyceraldehyde-3-Phosphate](#)

[Sedoheptulose-7-Phosphate](#)

[Erythrose-4-Phosphate](#)

[Fructose-6-Phosphate](#)

See also: [Pentose Phosphate Pathway](#), [Enzymes of the Pentose Phosphate Pathway](#)

INTERNET LINK: [Pentose Phosphate Cycle](#)

6-Phosphogluconolactone

6-phosphogluconolactone is a [pentose phosphate pathway](#) intermediate produced by [glucose-6-phosphate dehydrogenase](#) - catalyzed oxidation of [glucose-6-phosphate](#). **6-phosphogluconolactone** is converted to 6-phosphogluconate by action of the enzyme lactonase.

See also: [Pentose Phosphate Pathway Intermediates](#),
[Lactonase](#), [Pentose Phosphate Pathway Enzymes](#)

INTERNET LINK: [Pentose Phosphate Pathway](#)

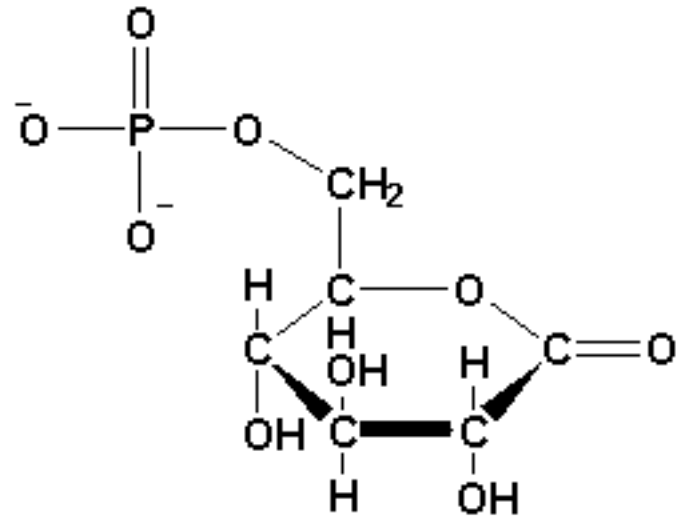

6-phosphogluconolactone

Glucose-6-phosphate dehydrogenase (G6PDH)

G6PDH is an enzyme of the pentose phosphate pathway that catalyzes the reaction below:



Individuals whose **G6PDH** is partly inactive are prone to oxidative stress. This arises because NADPH produced by the pentose phosphate pathway is required for reduction of glutathione, which, in turn, helps reduce peroxides. In the absence of sufficient NADPH, glutathione remains oxidized and peroxides cannot be neutralized.

See also: [Pentose Phosphate Pathway \(PPP\)](#), [PPP Enzymes](#)

INTERNET LINK: [Pentose Phosphate Pathway](#)

Enzymes of the Pentose Phosphate Pathway

The enzymes of the pentose phosphate pathway are listed below:

[Lactonase](#)

[6-Phosphogluconate Dehydrogenase](#)

[Phosphopentose Isomerase](#)

[Phosphopentose Epimerase](#)

[Transketolase](#)

[Transaldolase](#)

See also: [Pentose Phosphate Pathway](#), [Intermediates of the Pentose Phosphate Pathway](#), [Calvin Cycle](#) (from Chapter 17)

INTERNET LINK: [Pentose Phosphate Cycle](#)

Lactonase

Lactonase is an enzyme of the pentose phosphate pathway that catalyzes the reaction below:



See also: [Pentose Phosphate Pathway \(PPP\)](#), [PPP Enzymes](#)

INTERNET LINK: [Pentose Phosphate Pathway](#)

6-Phosphogluconate

6-phosphogluconate is a [pentose phosphate pathway](#) intermediate produced by [lactonase](#)-catalyzed hydrolysis of [6-phosphogluconolactone](#). **6-phosphogluconate** is converted to [ribulose-5-phosphate](#) by action of the enzyme [6-phosphogluconate dehydrogenase](#).

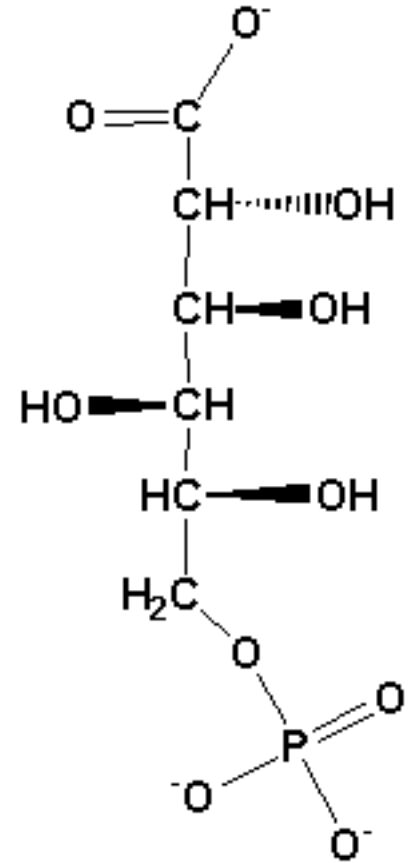

6-phosphogluconate

See also: [Pentose Phosphate Pathway \(PPP\)](#), [PPP Enzymes](#), [PPP Intermediates](#)

INTERNET LINK: [Pentose Phosphate Pathway](#)

Gluconeogenesis and Glycolysis Regulation Link Page

Gluconeogenesis and **glycolysis** both proceed largely in the cytosol. Because gluconeogenesis synthesizes **glucose** and glycolysis catabolizes glucose, it is evident that gluconeogenesis and glycolysis must be controlled in reciprocal fashion. If not for reciprocal control, glycolysis and gluconeogenesis would operate together as a giant futile cycle.

Conditions of low energy charge tend to activate the rate-controlling steps in **glycolysis** while inhibiting carbon flux through **gluconeogenesis**. Conversely, gluconeogenesis is stimulated at high energy charge, under conditions where catabolic flux rates are adequate to maintain sufficient **ATP** levels.

Regulation of the two pathways primarily is brought about by allosteric controls on the enzymes that differ between the two pathways. These enzymes are:

Glycolysis Enzyme	Gluconeogenesis Enzyme
Hexokinase	Glucose-6-phosphatase
Phosphofructokinase-1 (PFK-1)	Fructose 1,6 bisphosphatase
Pyruvate kinase (<u>note on isozymes</u>)	1. Pyruvate Carboxylase 2. Phosphoenolpyruvate carboxykinase (PEPCK)

1. **F2,6BP** and **AMP** activate **PFK-1** and inhibit **Fructose 1,6 bisphosphatase**
2. **G6P** substrate levels control **Hexokinase** and **Glucose-6-phosphatase**
3. **Acetyl-CoA** inhibits **Pyruvate kinase** and activates **Pyruvate Carboxylase**

Other control points on the two pathways are shown in **Figure 16.6**

The major allosteric regulatory factor of the two pathways is **Fructose 2,6 bisphosphate**. Note in **Figure 16.7** that **PFK-2 and Fructose 2,6-bisphosphatase** are on the same peptide and are affected differently by phosphorylation (see below). Interconversion of **PFK-2 and Fructose 2,6-bisphosphatase** depends on the level of **cAMP** (which is stimulated by **glucagon** and **epinephrine** and is inhibited by **insulin**). Increasing cAMP (glucagon/epinephrine) stimulates phosphorylation of **PFK-2 and Fructose 2,6-bisphosphatase**, favoring the **Fructose 2,6-bisphosphatase**. Decreasing cAMP

(insulin) stimulates dephosphorylation, favoring PFK-2.

Fructose-2,6-bisphosphatase is strongly inhibited by fructose-6-phosphate.

Glucagon represses transcription of pyruvate kinase.

Glucagon activates transcription of phosphoenolpyruvate carboxykinase

Insulin represses transcription of phosphoenolpyruvate carboxykinase..

See also: Reactions and Enzymes of Glycolysis

Figure 16.17: Biosynthesis of the lipid-linked oligosaccharide intermediate.

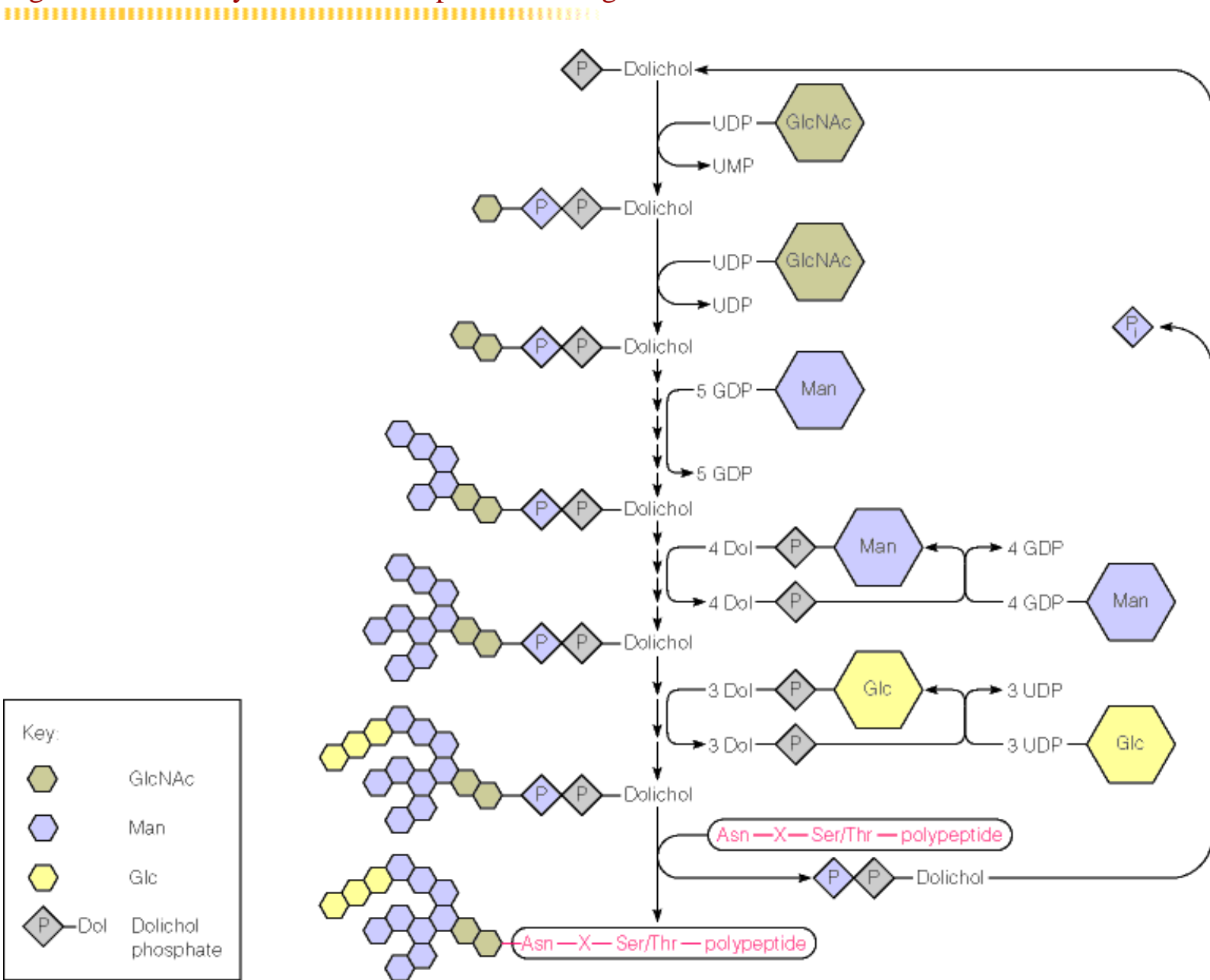

Pyruvate Carboxylase

Pyruvate carboxylase is an enzyme of gluconeogenesis. It catalyzes formation of a carboxyl group on pyruvate (using CO₂) to make oxaloacetate.



Pyruvate carboxylase is activated allosterically by acetyl-CoA. The enzyme is a tetrameric protein carrying four molecules of biotin, each bound covalently through an amide bond involving the ε-amino group of a lysine residue. In animals the reaction catalyzed by **pyruvate carboxylase** is the most important anaplerotic reaction, particularly in liver and kidney. **Pyruvate carboxylase** is the only enzyme of gluconeogenesis in the mitochondria, requiring pyruvate and oxaloacetate to be transported across the mitochondrial membrane for gluconeogenesis to occur.

See also: [Gluconeogenesis Enzymes](#), [Glycolysis Enzymes](#), [Pyruvate Kinase](#), [PEPCK](#), [Acetyl-CoA](#), [Biotin](#), [Glycolysis/Gluconeogenesis Regulation Links](#), [Gluconeogenesis](#), [Reciprocal Regulation](#), [Action of Glucagon](#)

INTERNET LINKS: [Glycolysis/Gluconeogenesis](#)

Phosphoglucoisomerase

Phosphoglucoisomerase catalyzes the interconversion of glucose-6-phosphate (G6P) and fructose-6-phosphate (F6P).



This reaction, which is also the second step of [glycolysis](#) and the next to last step of [gluconeogenesis](#), proceeds via an enediol intermediate (see [here](#)) and is readily reversible. The effect of transferring the carbonyl oxygen from carbon 1 to carbon 2 is that the hydroxyl group generated at carbon 1 can be readily phosphorylated.

[Previous step](#) of glycolysis / [Next step](#) of glycolysis

See also: [Enzymes of Glycolysis](#), [Molecules of Glycolysis](#)

INTERNET LINKS:

1. [RasMol Image of Phosphoglucoisomerase](#) (slow)
 2. [Glycolysis/Gluconeogenesis](#)
-

Unnumbered Item

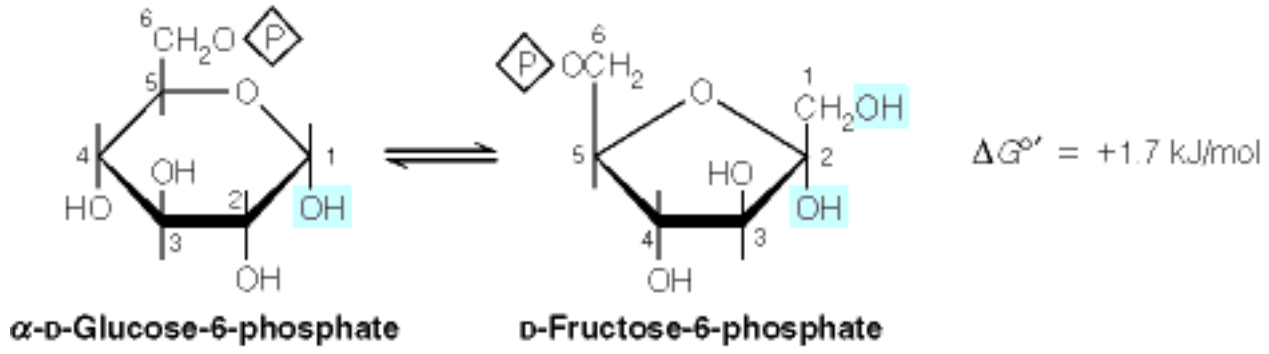

Glycerol

Glycerol is a product of fat metabolism. It can be converted to [glycerol-3-phosphate](#) in the liver by [glycerol kinase](#). This reaction consumes one molecule of ATP. Glycerol-3-phosphate is then oxidized by glycerol-3-phosphate dehydrogenase to dihydroxyacetone phosphate (DHAP), reducing one molecule of NAD^+ in the process. Once formed, [DHAP](#) can enter glycolysis, as shown in [Figure 13.12](#).

Free **glycerol** is also produced in synthesis of [cardiolipin](#) from [phosphatidylglycerol](#).

See also: [Glycerol-3-Phosphate Dehydrogenase](#), , [NAD⁺](#), [Glycolysis](#)

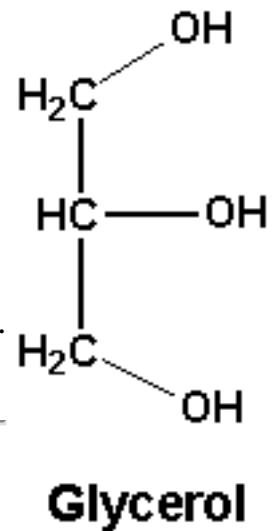

Cardiolipin

Cardiolipin is a glycerophospholipid made by combining two molecules of phosphatidylglycerol and splitting out one of the glycerol molecules ([Figure 19.4](#)).

Cardiolipin is present in heart muscle membranes and in the membranes of spirochetes, such as the organism that causes syphilis.

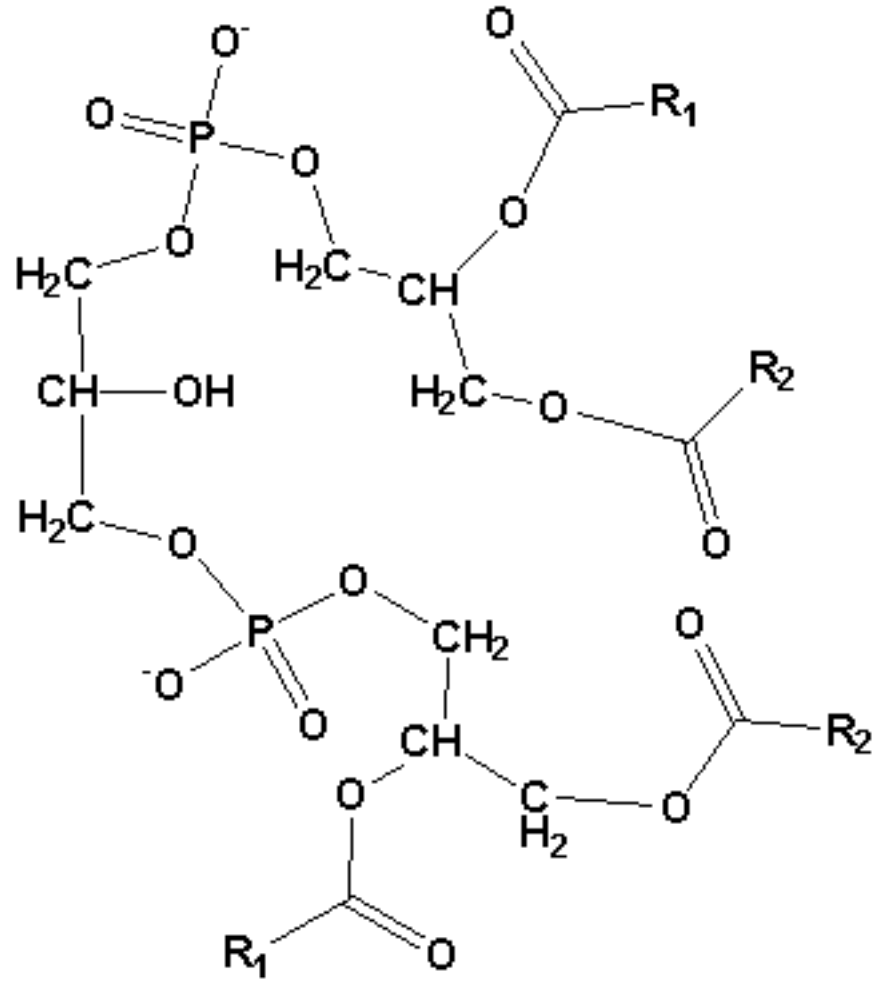

Cardiolipin

See also: [Glycerophospholipid Pathway](#), [Glycerophospholipids](#), [Glycerol](#), [Phosphatidylglycerol](#), [Initiation of DNA Replication](#)

INTERNET LINKS

1. [Glycerolipid Metabolism](#)
 2. [Phospholipid Catabolism](#)
-

Figure 19.4: Synthesis of polar head groups of bacterial phospholipids.

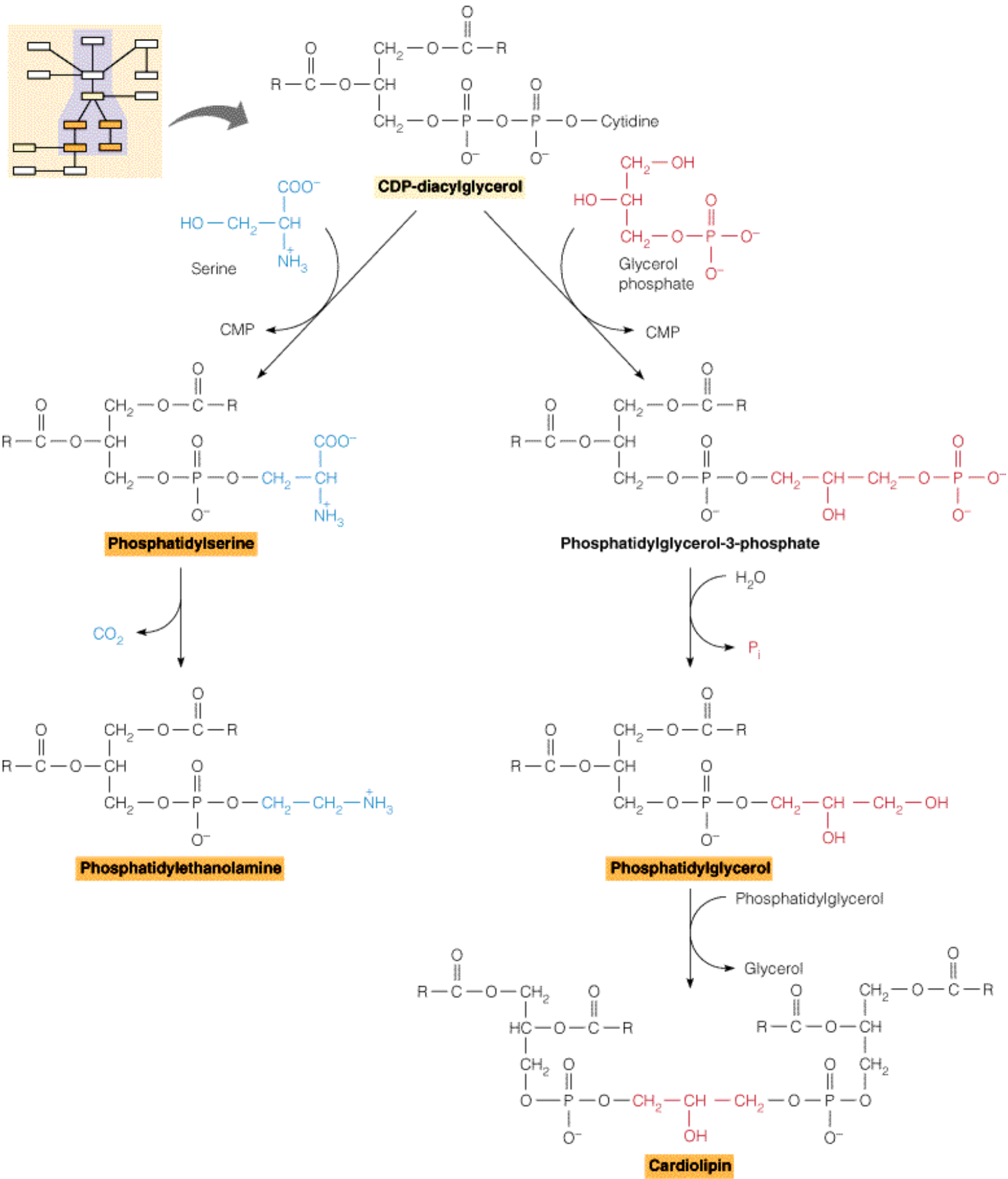

This is an Image Map of Glycerophospholipid Synthesis from Figure 19.2. Click on a Box to Link to the Molecule.

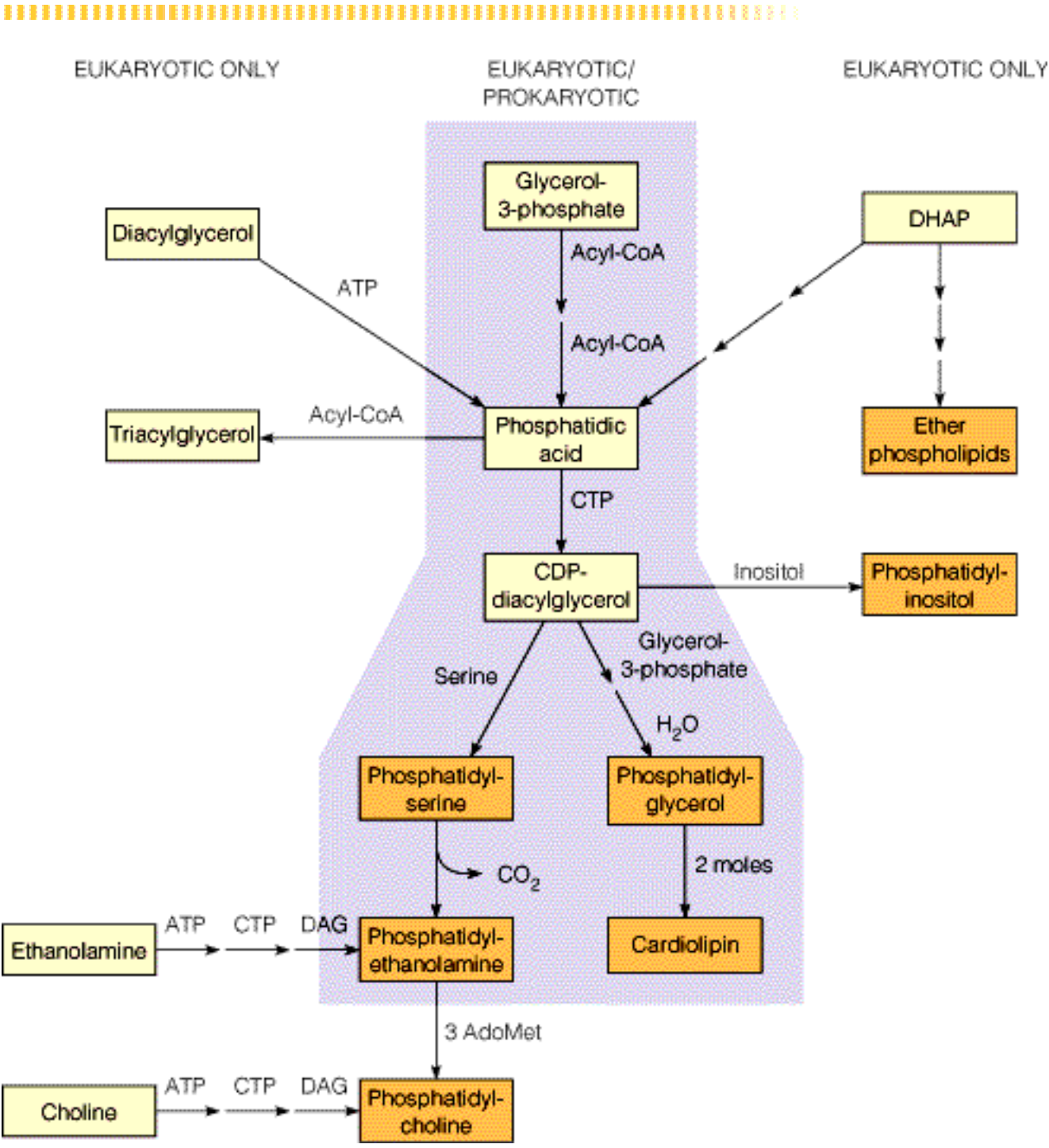

Diacylglycerol

A **diacylglycerol** is a glycerol with only two fatty acids esterified to it. Diacylglycerol can be produced in several ways. Digestion of a triacylglycerol by triacylglycerol lipase yields a **diacylglycerol**.

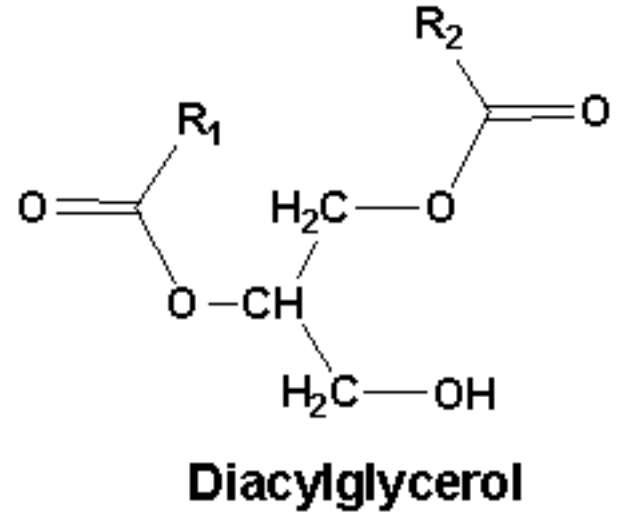

Diacylglycerol lipase catalyzes hydrolysis of a fatty acid from diacylglycerol to make a monoacylglycerol.



Diacylglycerol is also a participant in the reaction to make phosphatidylcholine:



See also: Pancreatic Lipase, Figure 19.2, Second Messenger Systems

Triacylglycerol Lipase (Hormone-Sensitive Lipase)

Triacylglycerol lipase is a hormonally regulated enzyme ([Figure 18.11](#)) that catalyzes the hydrolytic release of fatty acid from carbon 1 or 3 of the glycerol moiety. The fatty acid release is followed by the action of a diacylglycerol lipase and a monoacylglycerol lipase, in turn.

Together these three enzymes degrade the original molecule to glycerol and three unesterified fatty acids. In adipose tissue, the primary hormonal effects are mediated by epinephrine in stress situations and by glucagon during fasting.

See also: [Triglycerides](#), [Fatty Acids](#), [Diacylglycerol Lipase](#), [Monoacylglycerol Lipase](#), [Diacylglycerol](#), [Maintaining Blood Glucose Levels](#)

Figure 18.11: Control of triacylglycerol lipase activity in adipose cells by a cyclic AMP-mediated cascade system.

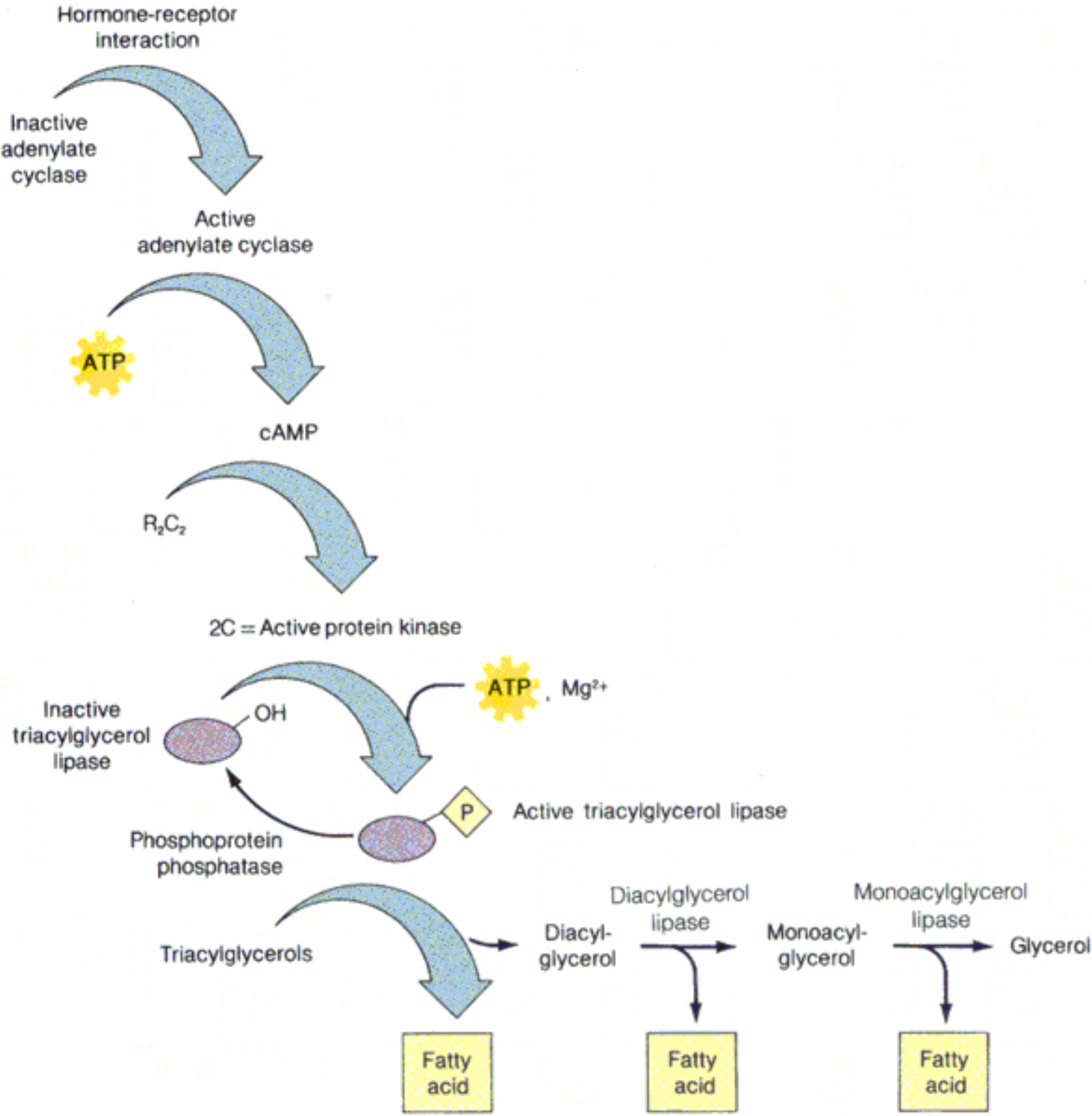

Diacylglycerol Lipase

Diacylglycerol lipase is an enzyme that hydrolyzes a **fatty acid** from a diacylglycerol (glycerol with only two fatty acids esterified to it) to yield a monoacylglycerol and a free fatty acid.



Diacylglycerols arise from action of triacylglycerol lipase on a fat (triacylglycerol), which hydrolyzes one of the three fatty acids from it (at position one or three). Further digestion of the monoacylglycerol requires the action of monoacylglycerol lipase.

See also: [Monoacylglycerol Lipase](#), [Diacylglycerol](#), , [Triacylglycerol Lipase](#), [Fat](#)

Monoacylglycerol

A **monoacylglycerol** is a glycerol with only one fatty acid esterified to it. **Monoacylglycerol** can be produced by digestion of a diacylglycerol by diacylglycerol lipase. Hydrolysis of the **monoacylglycerol**, catalyzed by monoacylglycerol lipase, yields glycerol and a free fatty acid, as follows:



See also: Triacylglycerol Lipase

Monoacylglycerol Lipase

Monoacylglycerol lipase is an enzyme that hydrolyzes a fatty acid from a monoacylglycerol (glycerol with one fatty acid esterified to it) to yield glycerol and a free fatty acid. Monoacylglycerols arise from action of diacylglycerol lipase on a diacylglycerol, which hydrolyzes one of the two fatty acids from it. Further digestion of the monoacylglycerol requires the action of monoacylglycerol lipase.

See also: [Fatty Acids](#), [Glycerol](#), [Diacylglycerol](#), [Diacylglycerol Lipase](#)

Maintaining Blood Glucose Levels

Figure 23.4 shows how blood **glucose** levels are maintained in the body under varying dietary conditions.

Blood glucose increases shortly after a carbohydrate-containing meal, which stimulates the secretion of **insulin** and suppresses the secretion of **glucagon**, in order to remove glucose from the blood. These effects promote the uptake of glucose into the liver, stimulate **glycogen synthesis**, and suppress **glycogen breakdown**. Activation of **acetyl-CoA carboxylase** in the liver stimulates fatty acid synthesis, with subsequent transport to adipose tissue as **triacylglycerols** in **very low-density lipoproteins**. There, increased levels of glycolytic intermediates and **fatty acids** stimulate triacylglycerol synthesis. Finally, increased glucose uptake into muscle increases levels of substrates for glycogen synthesis in that tissue as well.

Several hours later, when dietary glucose is not available, the above events are reversed in order to elevate **blood glucose** levels. Insulin secretion slows, and glucagon secretion increases. This promotes glycogen breakdown in liver via the **cAMP-dependent cascade** mechanisms that activate **glycogen phosphorylase** and inactivate **glycogen synthase**. Triacylglycerol breakdown in adipocytes is activated as well, via the action of **hormone-sensitive lipase**, generating fatty acids for use as fuel by liver and muscle. At the same time, the decrease in insulin levels reduces glucose use by muscle, liver, and adipose tissue. Consequently, nearly all the glucose produced in the liver is exported to the blood and is available for use by the brain.

See also: [Response to Starvation](#), [Diabetes](#), [Action of Insulin](#)

Figure 23.4: Major events in the storage, retrieval, and use of fuels in the fed and unfed states and in early starvation.

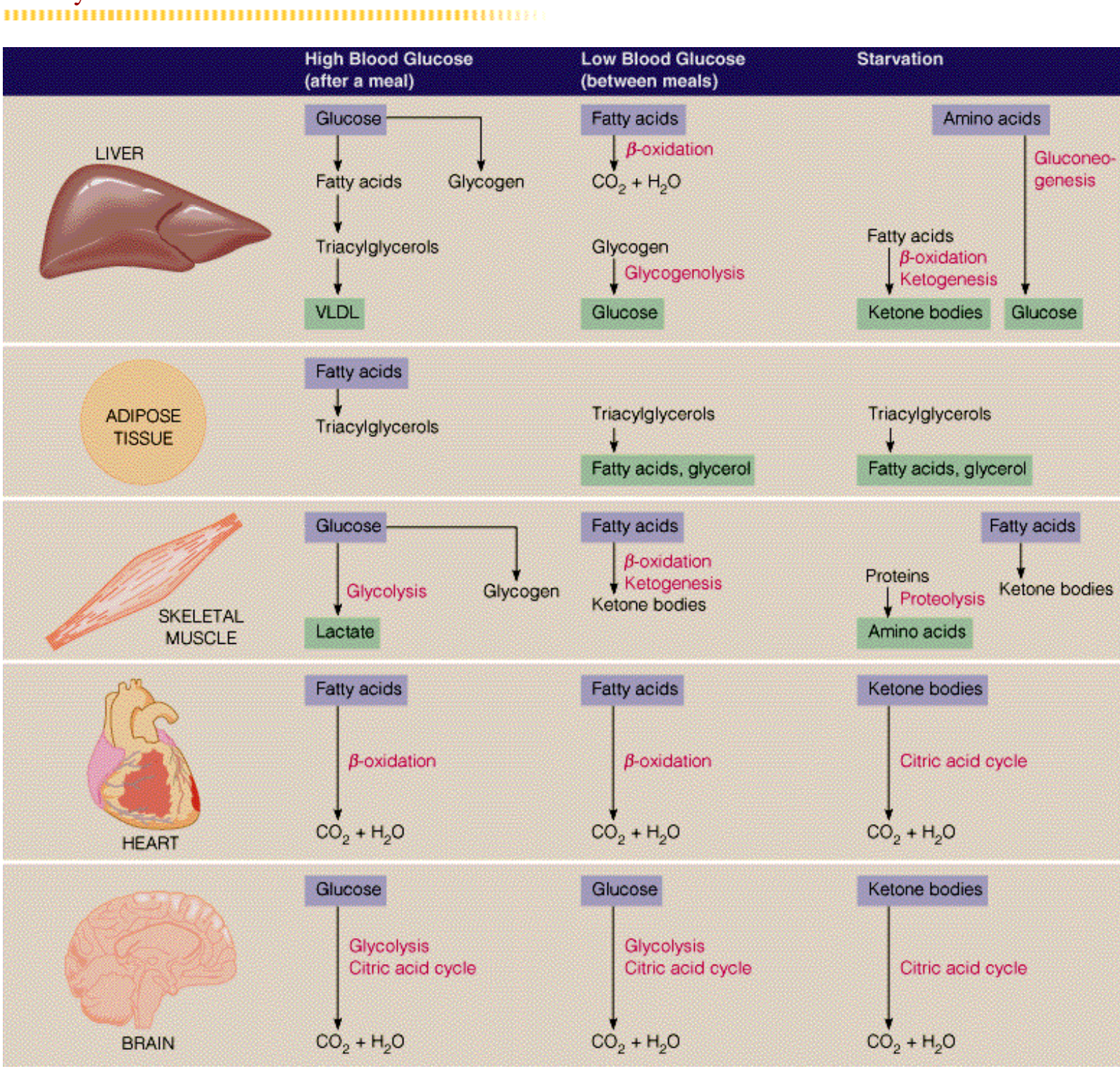

Glycogen Biosynthesis

A major fate of glucose in animals is the synthesis of **glycogen**. [Figure 16.8](#) schematically depicts the steps by which glucose is incorporated into a glycogen chain. In addition to the steps shown here, a process that introduces branches in the chain is an important part of **glycogen synthesis** and is shown in [Figure 16.10](#). Apart from hexokinase, which is a glycolytic enzyme, **glycogen biosynthesis** employs only four other enzymes. These are summarized as follows:

Phosphoglucomutase - catalyzes the interconversion of glucose-1-phosphate (G1P) and glucose-6-phosphate (G6P).

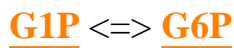

This enzyme is the common link between glycogen biosynthesis and glycogen breakdown.

UDP-glucose pyrophosphorylase - catalyzes the transfer of glucose (from G1P) to uridine triphosphate, forming UDP-glucose and pyrophosphate.



This has the effect of "activating" glucose for incorporation into the growing glycogen chain in the next step of the process. Furthermore, this reaction is made essentially irreversible by hydrolysis of the pyrophosphate to 2Pi.

Glycogen Synthase - catalyzes the formation of an $\alpha(1 \rightarrow 4)$ glycosidic bond between carbon 4 of an existing glycogen chain and carbon 1 of a glucose (from UDP-glucose). UDP is released in the process. Glycogen synthase is the major point of regulation of glycogen biosynthesis. The reaction is depicted in [Figure 16.9](#).

Amylo-(1,4- \rightarrow 1,6)-transglycosylase (branching enzyme) - This enzyme, most commonly called **branching enzyme**, introduces the abundant $\alpha(1 \rightarrow 6)$ branches, which are characteristic of glycogen molecules. The reaction transfers a terminal fragment, some 6 or 7 residues long, from a branch terminus at least 11 residues in length to a hydroxyl group at the 6-position of a glucose residue in the interior of the polymer ([Figure 16.10](#)).

As a result of the transfer, two termini recognized by glycogen synthase are created where only one existed before. This means that the synthesis and the mobilization of glycogen can proceed quickly and efficiently, depending on the needs of the cell.

See also: [Reciprocal Regulation of Glycogen Biosynthesis and Mobilization](#), [Glycogen Metabolism Diseases](#), [Glycogen Catabolism](#) (from chapter 13), [Glycogen](#), [Glucose](#)

Figure 16.8: Pathway for conversion of glucose monomers to polymeric glycogen.

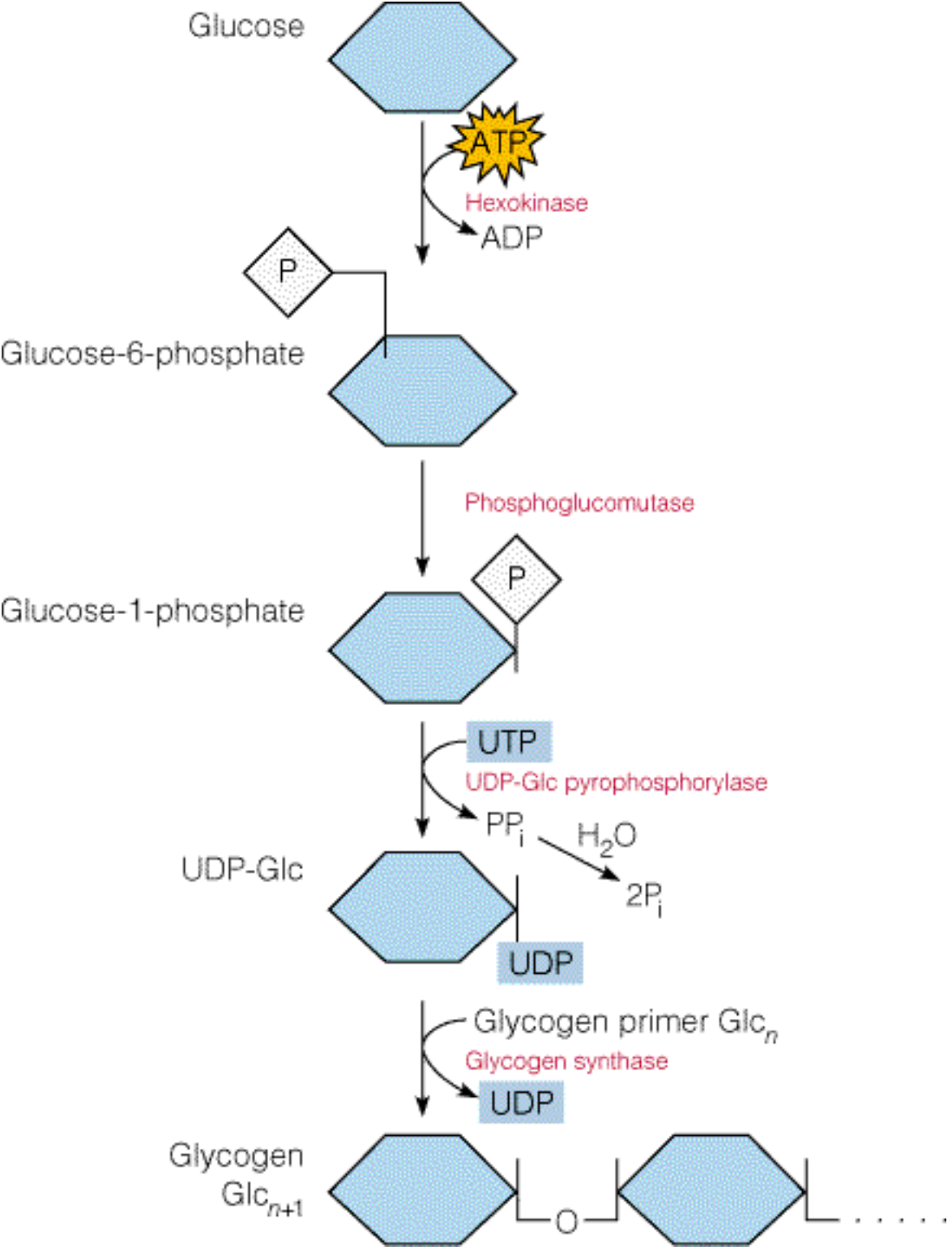
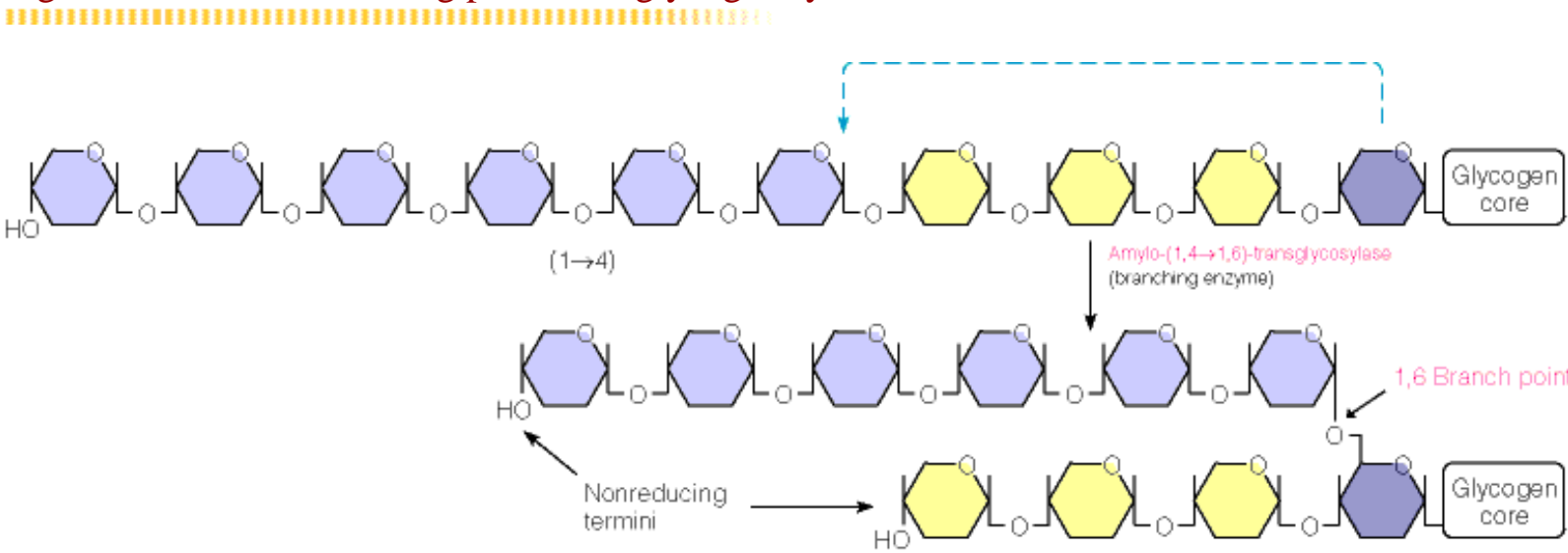

Figure 16.10: The branching process in glycogen synthesis.



Glycogen Synthase I

Glycogen synthase I, like the other form of the enzyme (glycogen synthase D), catalyzes the addition of a glucose molecule (from UDP-glucose) in an α 1,4 linkage to a growing glycogen chain. The two enzymes are identical except that glycogen synthase D arises from phosphorylation of **glycogen synthase I** by cAMP-dependent protein kinase or SPK. The phosphate group on glycogen synthase D causes it to be dependent on glucose-6-phosphate for activity. In the absence of glucose-6-phosphate, glycogen synthase is inactive.

cAMP-dependent protein kinase can phosphorylate **glycogen synthase I** directly, or it can phosphorylate SPK (also known as phosphorylase b kinase), which in turn is activated to phosphorylate **glycogen synthase I** (**Figures 16.11** and **16.12**). Phosphorylation converts **glycogen synthase I** to glycogen synthase D.

Conversion of the **D** form back to the **I** form requires action of the enzyme phosphoprotein phosphatase I. **Glycogen synthase I** is called the independent form of glycogen synthase, since it does not require glucose-6-phosphate for activity.

cAMP-dependent protein kinase requires cAMP for activity. Therefore, hormones, such as epinephrine and glucagon, which increase cAMP levels, tend to inactivate synthesis of glycogen due to conversion of **glycogen synthase I** to the dependent form (glycogen synthase D).

Conversely, hormones, such as insulin, which reduce cAMP levels and counteract the effects of cAMP-dependent protein kinase activity, stimulate dephosphorylation of glycogen synthase D by the enzyme phosphoprotein phosphatase I to the independent form (**I**) and favor glycogen synthesis.

See also: [Glycogen Synthase](#), [Glycogen Biosynthesis](#), [Glycogen Synthase D](#), [cAMP-Dependent Protein Kinase](#), [Kinase Cascade Phosphoprotein Phosphatase I](#), [Glycogen](#), [UDP-Glucose](#), [Glucose](#), [Glucose-6-Phosphate](#)

Figure 16.9: The glycogen synthase reaction.

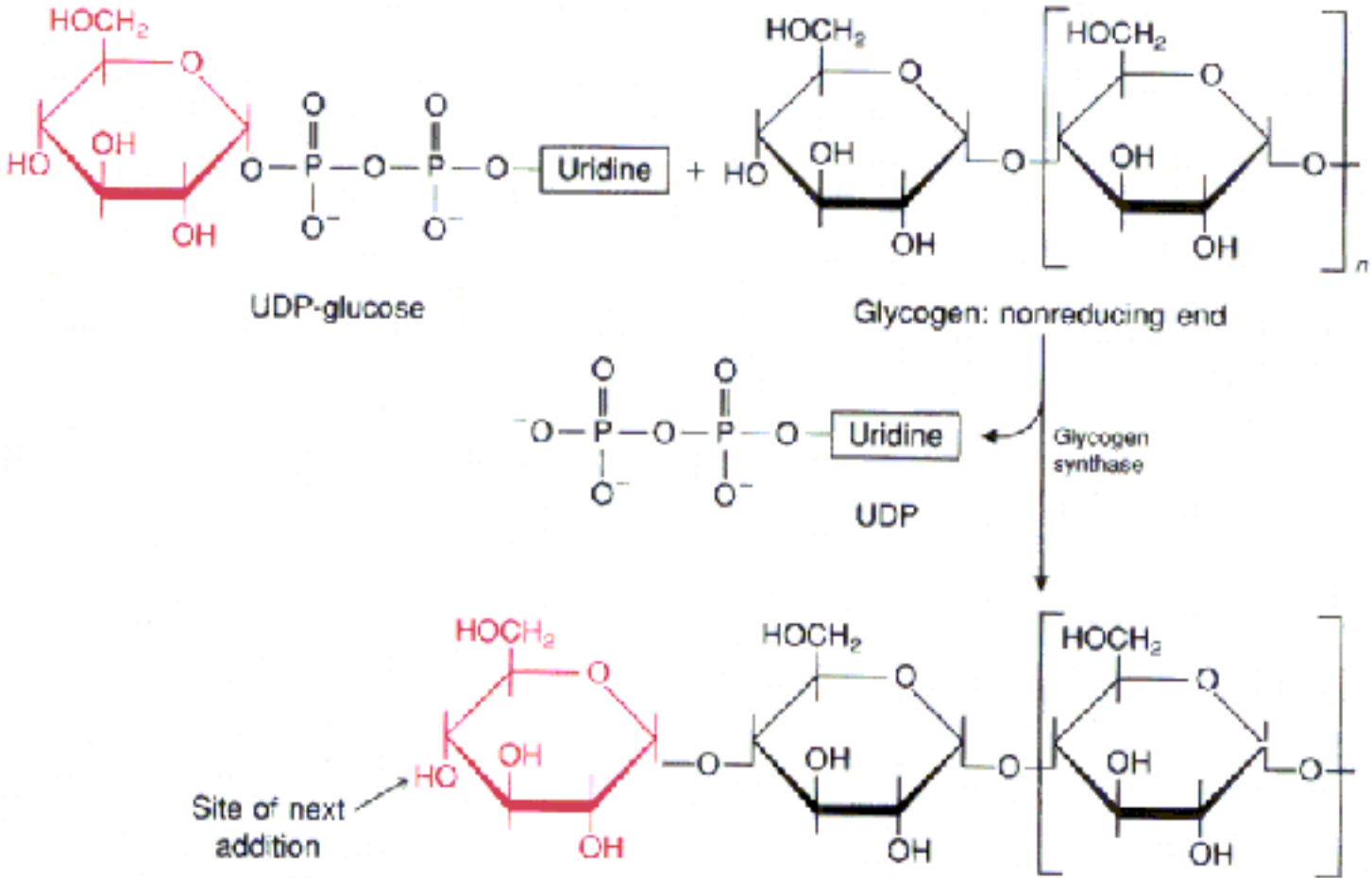

Reciprocal Regulation of Glycogen Biosynthesis and Mobilization

Glycogen synthesis and **breakdown** are controlled tightly by hormonal action. These involve regulatory kinase cascades, as depicted in [Figure 13.18](#) for glycogen breakdown. Like gluconeogenesis/glycolysis, **glycogen synthesis/breakdown** is reciprocally regulated. For example, epinephrine inhibits **glycogen synthesis** at the same time as it promotes **glycogen breakdown**.

[Glycogen synthase](#) is the primary regulatory enzyme in **glycogen synthesis**. Like [glycogen phosphorylase](#), the enzyme that breaks down glycogen, glycogen synthase exists in phosphorylated and dephosphorylated states. Some of the phosphorylations/dephosphorylations are catalyzed by the same protein kinases and phosphatases that regulate **glycogen breakdown**. [Figure 16.11](#) illustrates that the cAMP-stimulated kinase regulatory cascade for both **glycogen synthesis** and **breakdown pathways** is the same. The primary difference lies in the effect of phosphorylation on the primary regulatory enzymes, glycogen synthase (made less active) and glycogen phosphorylase a (made active).

When glycogen synthase is phosphorylated, its activity depends upon the presence of [glucose-6-phosphate](#). It is thus called the dependent form. The unphosphorylated form of glycogen synthase acts independently of glucose-6-phosphate and is called the independent form.

Note in [Figure 16.11](#) that active protein kinase can phosphorylate glycogen synthase directly, in addition to the phosphorylation by synthase-phosphorylase kinase (also called [phosphorylase b kinase](#)).

Dephosphorylation of glycogen synthase and glycogen phosphorylase reverses the effects of phosphorylation. This converts glycogen synthase to the independent form and glycogen phosphorylase to a less active form. The primary enzyme responsible for dephosphorylating the glycogen metabolism enzymes is [phosphoprotein phosphatase](#) (PP-1). It is regulated by another protein called [phosphoprotein phosphatase inhibitor](#) (PI-1). PI-1 is also phosphorylated by active [protein kinase](#). When phosphorylated, PI-1 inhibits PP-1.

Thus, [cAMP](#) stimulates a kinase cascade that phosphorylates the regulatory enzymes of glycogen metabolism. It simultaneously activates PI-1, which converts PP-1 to the inactive form. Conversely, action of insulin stimulates phosphatase activity in cells, completely reversing the kinase cascade and reversing the preferred activities of the glycogen metabolism enzymes.

The bottom line:

1. [Epinephrine](#) and [glucagon](#) stimulate glycogen breakdown. They do this via stimulating production of cAMP, which activates a kinase (phosphorylation) cascade, which activates glycogen phosphorylase, converts glycogen synthase to the dependent form, and inhibits phosphoprotein phosphatase.

2. **Insulin** stimulates dephosphorylation, which activates phosphoprotein phosphatase, which reverses the activities of the glycogen metabolism, converting glycogen synthase to the independent form and glycogen phosphorylase to the less active form.

See also: **Reciprocal Regulation**, **Kinase Cascade** (from chapter 13), **Glycogen Breakdown Regulation**,

Phosphoprotein Phosphatase I (PP-I)

Phosphoprotein Phosphatase I is an enzyme of glycogen regulatory pathways that acts to reverse the effects of the kinase cascade.

Phosphoprotein phosphatase counters the effects of the kinase cascade by removing phosphates from proteins (Figure 16.11 and Figure 16.12). Thus, it converts the phosphorylated glycogen phosphorylase a (more active) to the dephosphorylated glycogen phosphorylase b (less active) and also converts phosphorylated glycogen synthase D (less active) to the more active glycogen synthase I form (dephosphorylated). The activity of **phosphoprotein phosphatase I** is controlled by phosphoprotein phosphatase inhibitor.

See also: Insulin, Glycogen, Glycogen Phosphorylase a, Glycogen Phosphorylase b, Glycogen Synthase I, Glycogen Synthase D

Glycogen Synthase D

Glycogen synthase D, like the other form of the enzyme (glycogen synthase I), catalyzes the addition of a glucose molecule (from UDP-glucose) in an α 1,4 linkage to a growing glycogen chain. The two enzymes are identical except that **glycogen synthase D** arises from phosphorylation of glycogen synthase I by cAMP-dependent protein kinase or SPK (**Figures 16.11** and **16.12**). The phosphate group on glycogen synthase D causes it to be dependent on glucose-6-phosphate for activity. In the absence of glucose-6-phosphate, glycogen synthase is inactive.

cAMP-dependent protein kinase can phosphorylate glycogen synthase I directly, or it can phosphorylate SPK (also known as phosphorylase b kinase), which in turn is activated to phosphorylate glycogen synthase I. Phosphorylation converts glycogen synthase I to **glycogen synthase D**.

Conversion of the **D** form back to the I form requires action of the enzyme phosphoprotein phosphatase I. Glycogen synthase I is called the independent form of glycogen synthase, since it does not require glucose-6-phosphate for activity.

cAMP-dependent protein kinase requires cAMP for activity. Therefore, hormones, such as epinephrine and glucagon, which increase cAMP levels, tend to inactivate synthesis of glycogen due to conversion of glycogen synthase I to the dependent form (**glycogen synthase D**).

Conversely, hormones, such as insulin, which reduce cAMP levels and counteract the effects of cAMP-dependent protein kinase activity, stimulate dephosphorylation of **glycogen synthase D** by the enzyme phosphoprotein phosphatase I to the independent form (I) and favor glycogen synthesis.

See also: [Glycogen Synthase](#), [Glycogen Biosynthesis](#), [Glycogen Synthase I](#), [cAMP-Dependent Protein Kinase](#), [Kinase Cascade](#), [Phosphoprotein Phosphatase I](#), [Glycogen](#), [UDP-Glucose](#), [Glucose](#), [Glucose-6-Phosphate](#)

Phosphoprotein Phosphatase Inhibitor (PI-1)



Phosphoprotein phosphatase inhibitor regulates the activity of phosphoprotein phosphatase I ([Figure 16.12](#)). A phosphorylated form of **PI-1** is active as an inhibitor, and the dephosphorylated form is inactive. Phosphorylation of **PI-1** is carried out by C, the catalytic subunit of the cAMP-dependent protein kinase.

See also: [Phosphoprotein Phosphatase I](#), [cAMP-Dependent Protein Kinase](#)

Reciprocal Regulation

Gluconeogenesis synthesizes **glucose**, whereas **glycolysis** catabolizes it, both occurring in the same cellular location, the cytoplasm. Because gluconeogenesis uses more **ATP** and **GTP** energy than glycolysis generates, it would be counterproductive for the cell to operate both pathways at the same time. The net product of these two pathways would be a futile cycle in which large quantities of ATP and GTP energy would be lost. The term "futile cycle" is used to describe situations in which catabolic and biosynthetic pathways such as these are occurring at the same time.

The simplest mechanism for regulating opposing pathways is in a **reciprocal** fashion. That is, intracellular conditions that activate one pathway simultaneously inhibit the other. Though this can be accomplished in a variety of ways, the most common one is allosteric regulation of key control enzymes for the two pathways. In **Figure 16.6**, for example, which illustrates the **reciprocal regulatory** mechanisms of glycolysis and gluconeogenesis, the key control points are the interconversions of glucose and **glucose-6-phosphate**, **fructose-6-phosphate** and **fructose-1,6-bisphosphate**, and **phosphoenolpyruvate** and **pyruvate**. In both pathways, these are the most strongly exergonic interconversions and thus, the ones that most distinctly differentiate glycolysis from gluconeogenesis.

Reciprocal regulation of the glycolysis and gluconeogenesis pathways is related in large part to the adenylate energy charge. Conditions of low energy charge tend to activate the rate-controlling steps in glycolysis, while inhibiting carbon flux through gluconeogenesis. Conversely, gluconeogenesis is stimulated at high energy charge, under conditions where ATP levels remain sufficiently high.

Other **reciprocal regulators** of glycolysis and gluconeogenesis are **fructose-2,6-bisphosphate** and acetyl-CoA. See **Figure 16.7** for additional details about the reciprocal regulatory mechanisms of action of fructose-2,6-bisphosphate.

Acetyl-CoA is a **reciprocal regulator** because it activates **pyruvate carboxylase** (the enzyme that converts pyruvate to **oxaloacetate** in the two-step conversion of pyruvate to phosphoenolpyruvate in gluconeogenesis) and it inhibits **pyruvate kinase** (the enzyme that converts PEP to pyruvate in glycolysis). Thus, rising levels of acetyl-CoA may signal that adequate substrates are available to provide energy through the citric acid cycle and that more carbon can be shuttled into gluconeogenesis and ultimately stored as glycogen.

See also: [Regulation of Gluconeogenesis](#), [Reciprocal Regulation of Glycogen Biosynthesis and Mobilization](#), [Fructose-2,6-Bisphosphate in Gluconeogenesis Regulation](#)

Biotin

Biotin is a vitamin and a coenzyme commonly associated with enzymes performing carboxylation reactions. **Biotin** is typically linked covalently to carboxylase enzymes through the ϵ -amino nitrogen of lysine. **Biotin** is very tightly bound by avidin, a protein found in egg white. The strong interaction between these molecules is exploited in numerous purification techniques in biotechnology.

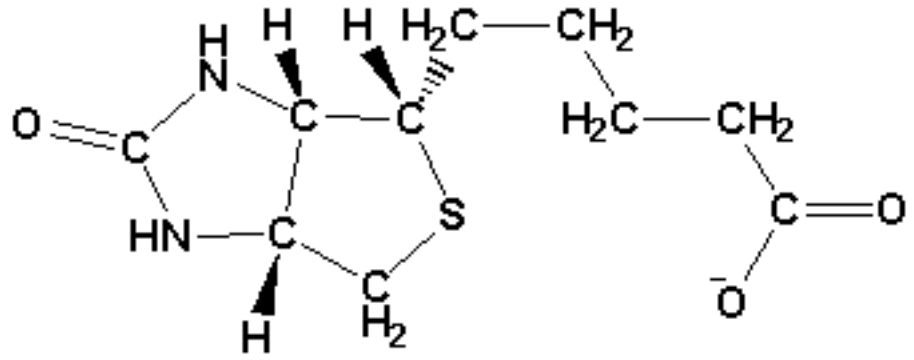

Biotin

Enzymes containing **biotin** include [acetyl CoA carboxylase](#), [pyruvate carboxylase](#), and [carbamoyl phosphate synthetase II](#)

See also: [Table 11.5, Pyruvate Carboxylase](#)

Carbamoyl Phosphate Synthetase II

Carbamoyl phosphate synthetase is an enzyme in pyrimidine biosynthesis that catalyzes the reaction below.



The enzyme is unusual in assimilating bicarbonate without using biotin as a cofactor.

Carbamoyl phosphate synthetase is the primary regulatory enzyme in pyrimidine biosynthesis of eukaryotes ([Figure 11.35](#)). In mammals, **carbamoyl phosphate synthetase II** is inhibited by the following pyrimidine-containing compounds: [UDP](#), [UTP](#), [CTP](#), [dUDP](#), and [UDP-glucose](#).

By contrast, aspartate transcarbamoylase ([ATCase](#)) is the major control point in the pyrimidine pathway synthesis in bacteria.

See also: [Biotin](#), [Pyrimidine Nucleotide Metabolism](#) (from Chapter 22), [Carbamoyl Phosphate Synthetase I](#)

Figure 11.35: Control points in pyrimidine synthesis.

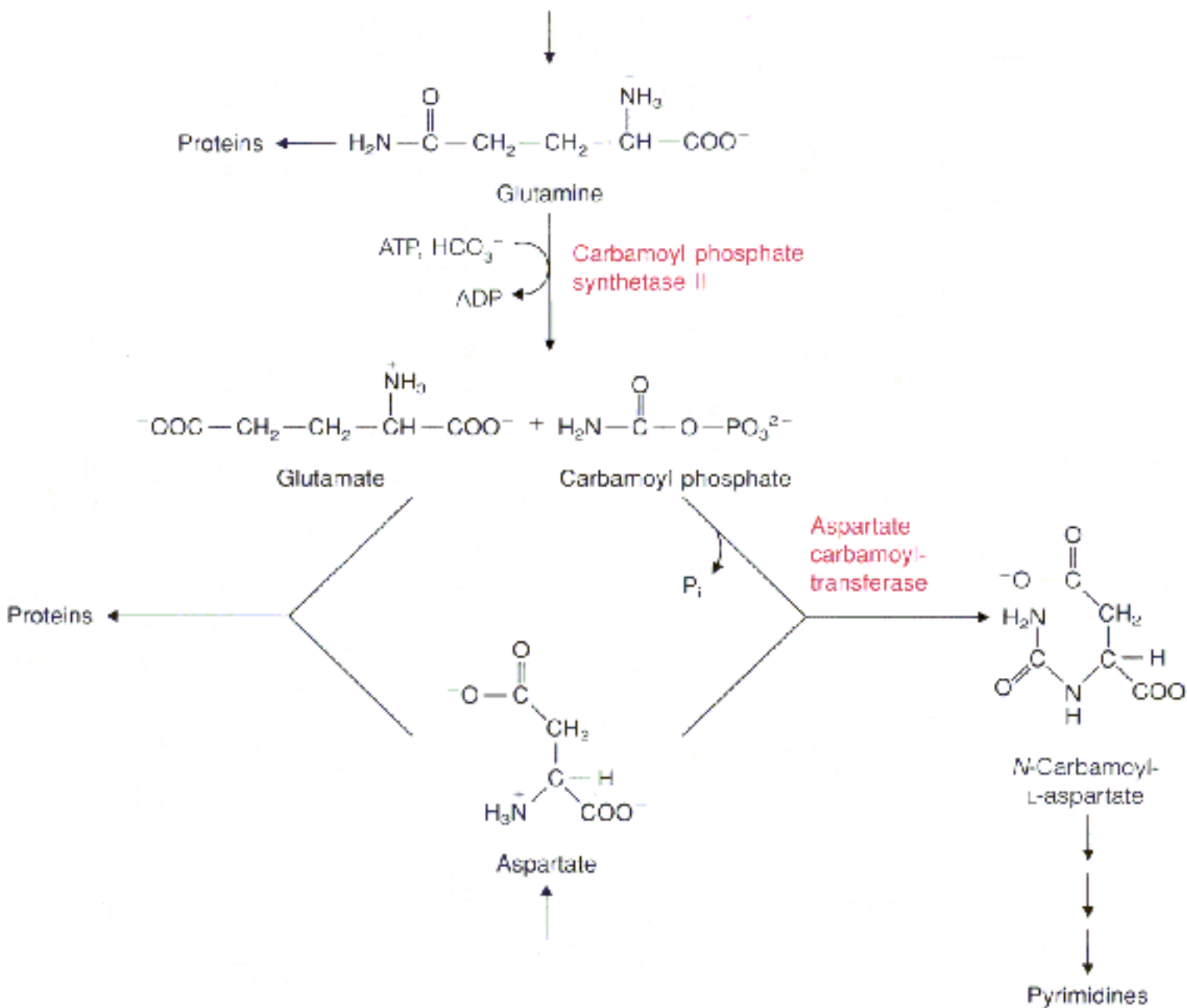

Uridine Diphosphate (UDP)

UDP is a nucleotide intermediate in pyrimidine biosynthesis. It is produced from **UMP** by UMP kinase, as shown in **Figure 22.10** and is converted to **UTP** by **nucleoside diphosphokinase** (also in **Figure 22.10**).

See also: [De Novo Pyrimidine Nucleotide Metabolism](#),
[Nucleotide Salvage Synthesis](#),
[Nucleotides](#)

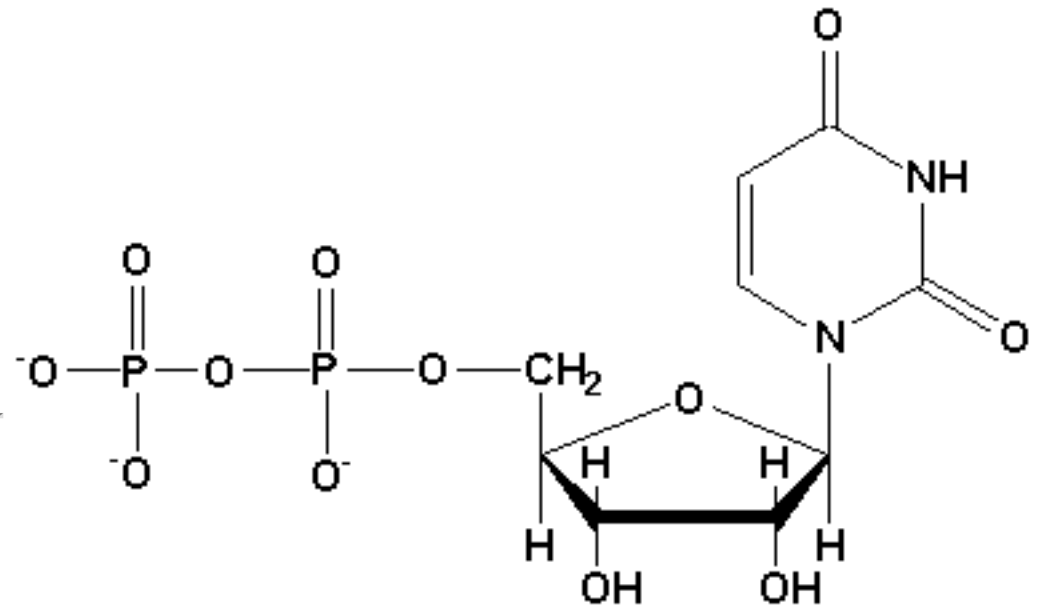

Uridine diphosphate (UDP)

Uridine Monophosphate (UMP)

UMP is a nucleotide intermediate in pyrimidine biosynthesis. It is produced by salvage synthesis and by the *de novo* pathway shown in [Figure 22.10](#).

See also: [Nucleotides](#), [De Novo Pyrimidine Nucleotide Metabolism](#), [Nucleotide Salvage Synthesis](#)

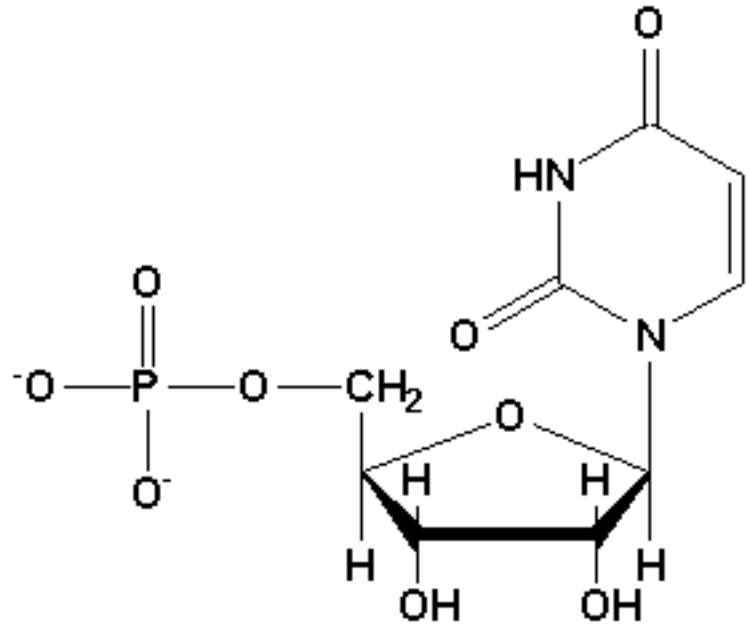

Uridine Monophosphate (UMP)

Nucleotide Salvage Synthesis

Salvage synthesis refers to the reuse of parts of nucleotides in resynthesizing new nucleotides. **Salvage synthesis** requires both breakdown and synthesis reactions in order to exchange the useful parts.

Important enzymes in the salvage synthesis of nucleotides ([Figure 22.2](#)) are as follows:

1. [Phosphoribosyl transferases](#), which interconvert free bases plus PRPP with nucleoside monophosphates;
2. [Nucleotidases](#), which cleave phosphates from nucleoside monophosphates to form free nucleosides;
3. Nucleoside kinases, which phosphorylate nucleosides to nucleoside monophosphates (see [here](#));
4. Phosphorylases (see [Figure 22.2](#)), which use phosphate to separate the base from ribose, forming free bases and [ribose-1-phosphate](#).
5. Phosphodiesterases, which convert oligonucleotides to nucleoside monophosphates;
6. Endonucleases, which convert nucleic acids to oligonucleotides (see [Figure 22.2](#))

See also: [Salvage Routes to Deoxyribonucleotide Synthesis](#)

Figure 22.2: Reutilization of purine and pyrimidine bases.

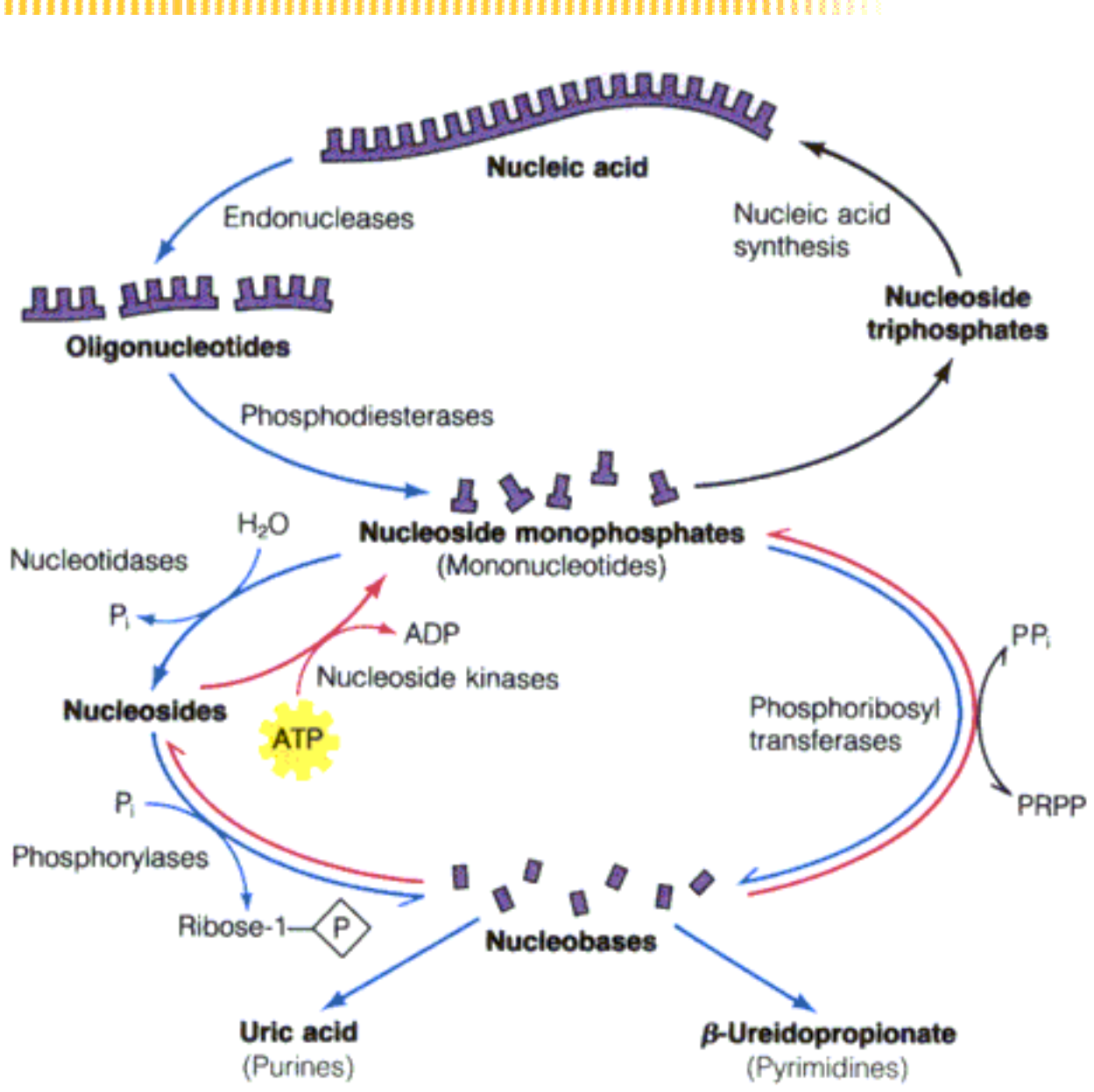

Phosphoribosyl Transferases



Phosphoribosyl transferases are enzymes involved in the salvage synthesis of nucleotides catalyzing the reactions below (see [here](#) also):

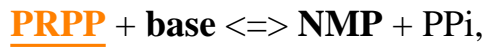

where NMP is a nucleoside monophosphate, such as AMP.

For example, one such reaction is



See also: [Nucleotide Salvage Synthesis](#)

Unnumbered Item

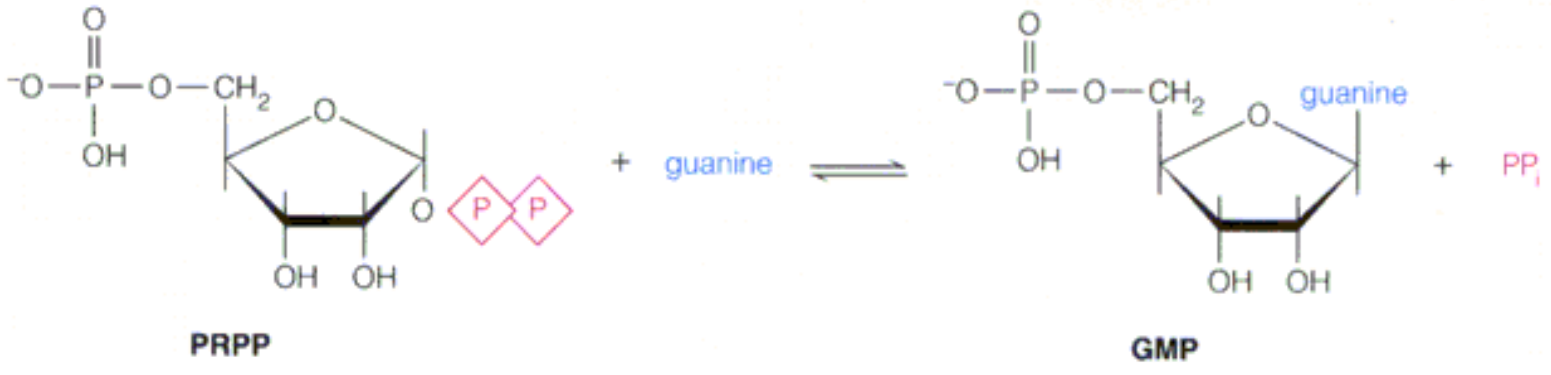

Nucleotidases

Nucleotidases are enzymes that hydrolyze a phosphate from a nucleoside monophosphate to yield a nucleoside and a free phosphate ([Figure 22.2](#)). An example reaction catalyzed by a **nucleotidase** is as follows:

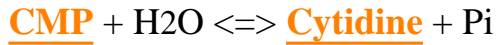

[Figure 22.7](#) shows pathways of purine catabolism leading to [uric acid](#). As seen in the figure, [AMP](#) and [GMP](#) can both be hydrolyzed from their phosphates by [nucleotidase](#), ultimately yielding the bases [hypoxanthine](#) and [xanthine](#), respectively.

See also: [Pathways in Nucleotide Metabolism](#), [Nucleotide Salvage Synthesis](#), [Purine Degradation](#), [Pyrimidine Catabolism](#)

Cytidine Monophosphate (CMP)

CMP is a **pyrimidine** nucleotide that is an intermediate in several metabolic pathways. It arises from synthesis of phosphatidic acid-containing compounds. In addition to being an intermediate in de novo pyrimidine biosynthesis, it participates in the reactions that follow:

1. **CTP** + **Sialic acid** \rightleftharpoons **CMP-Sialic acid**

2. **CDP--Choline** + **Diacylglycerol** \rightleftharpoons **CMP** + **Phosphatidylcholine** (catalyzed by **CDP-Choline: 1,2-Diacylglycerol Phosphocholine Transferase**)

3. **CMP** + H₂O \rightleftharpoons **Cytidine** + Pi (catalyzed by Nucleotidase)

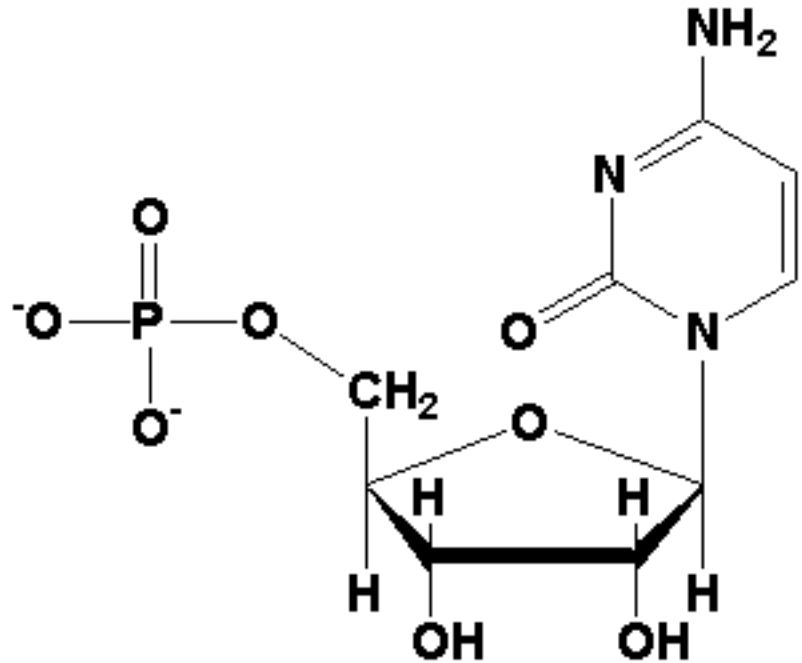

Cytidine Monophosphate (CMP)

See also: [Nucleotides](#), [Cytosine](#), [De Novo Pyrimidine Nucleotide Metabolism](#)

Uridine

Uridine is a nucleoside containing uracil. **Uridine** differs from uracil in containing a sugar (ribose). Phosphorylation of **uridine** produces a nucleotide found in RNA.

Deoxyuridine is a related nucleoside that contains deoxyribose instead of ribose as the sugar.

See also: Figure 4.3, DNA, Deoxyuridine Nucleotide Metabolism, Biosynthesis of Thymine Deoxyribonucleotides

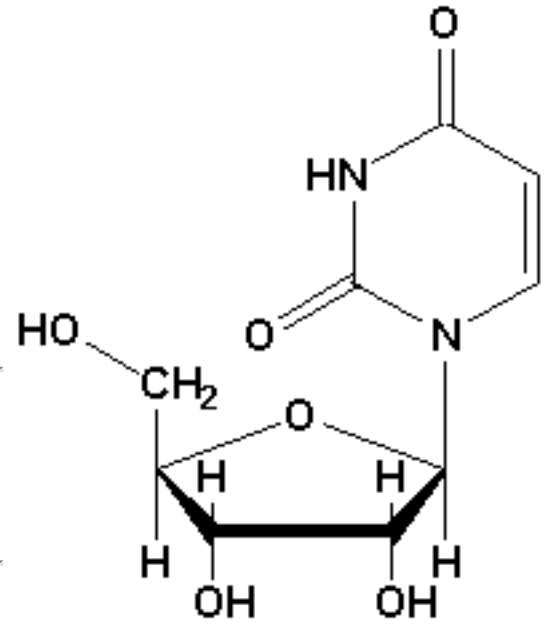

Uridine

Figure 22.12: Overview of deoxyribonucleoside triphosphate (dNTP) biosynthesis.

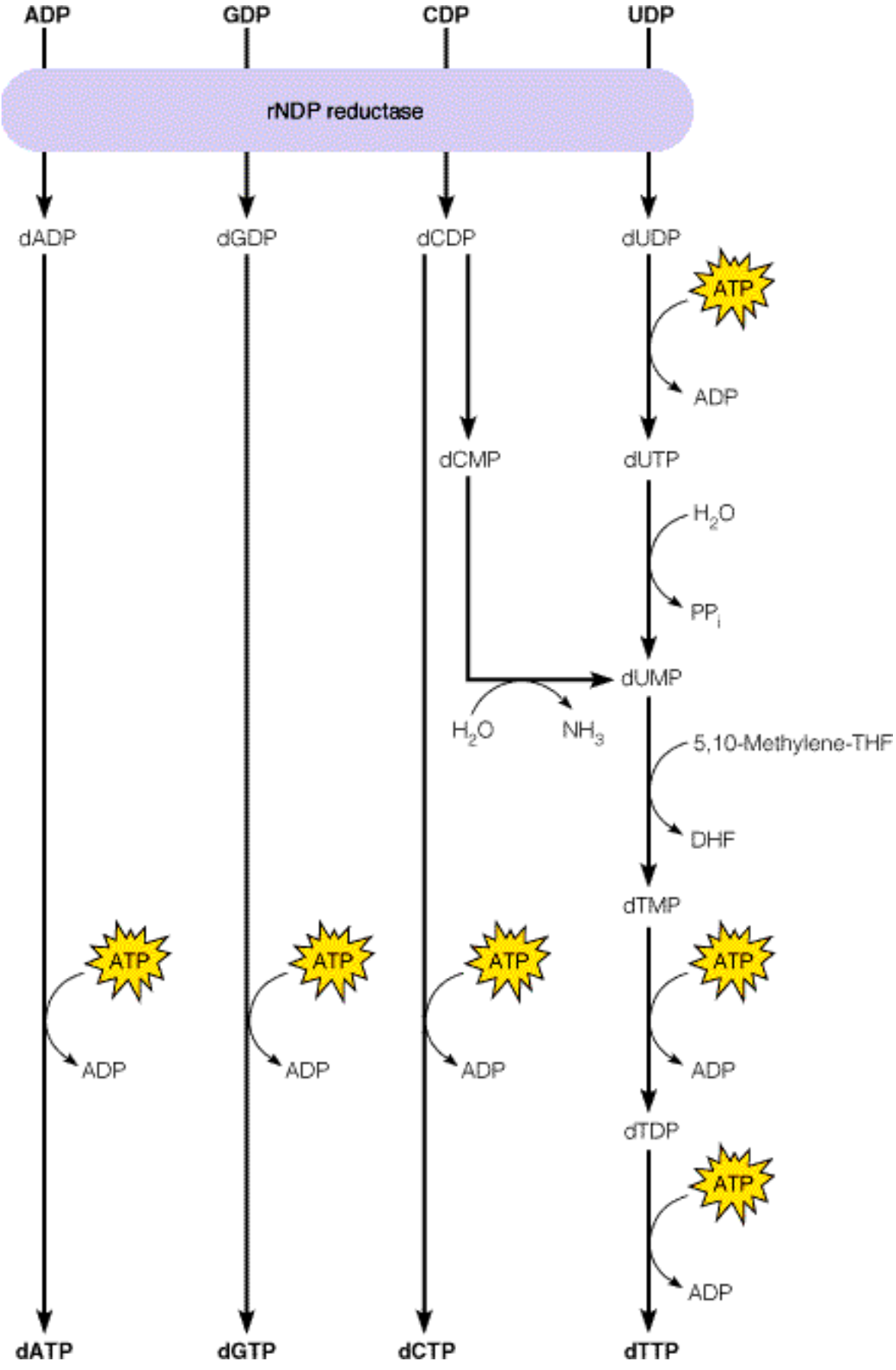

↓
dATP

↓
dGTP

↓
dCTP

↓
dTTP

ADP

Deoxyadenosine Triphosphate (dATP)

dATP is a substrate for DNA polymerase in synthesis of DNA. It is produced from dADP by **nucleoside diphosphokinase** catalysis as follows:

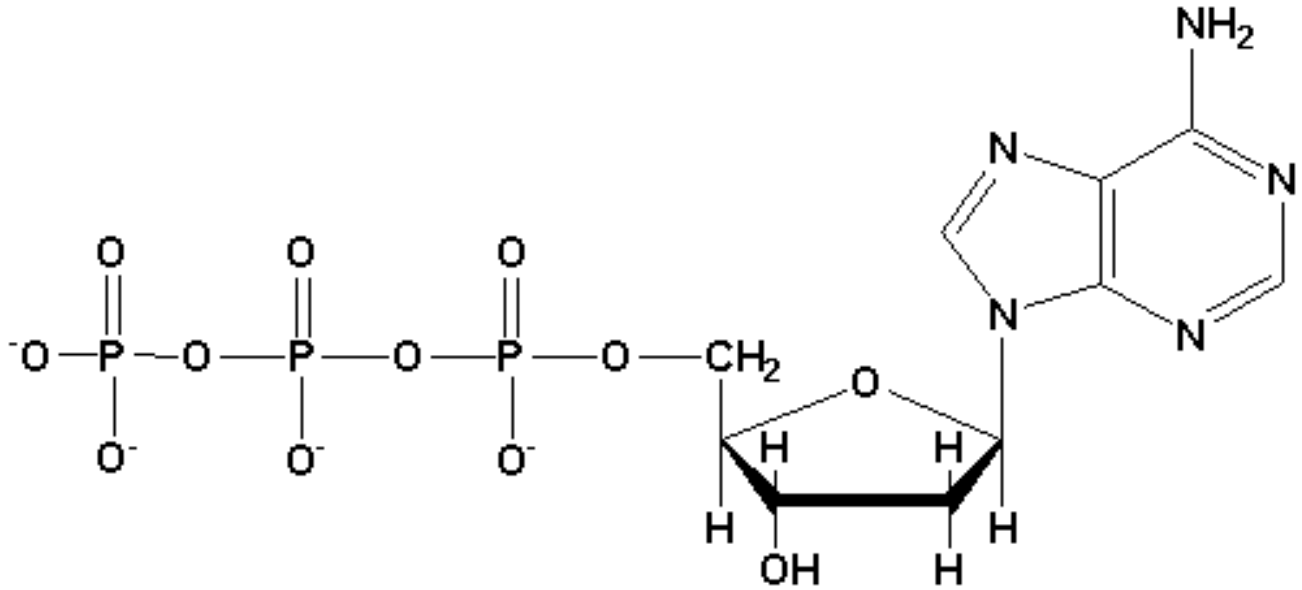
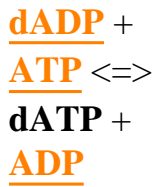

Deoxyadenosine Triphosphate (dATP)

dATP is also implicated in severe combined immune deficiency (SCID) (see [here](#)).

See also: [Nucleotides](#)

Nucleoside Diphosphokinase (NDPK)

NDPK is an enzyme that catalyzes the reaction that follows:

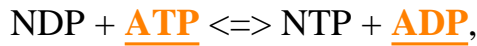

where NDP is a nucleoside diphosphate ([ADP](#), [GDP](#), [CDP](#), or [UDP](#)) and NTP is a nucleoside triphosphate ([ATP](#), [GTP](#), [CTP](#), or [UTP](#)). The enzyme will also use dNDPs as its substrates, as follows,

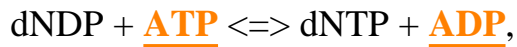

where dNDP is a deoxynucleoside diphosphate ([dADP](#), [dCDP](#), [dUDP](#), [dGDP](#), or [dTDP](#)) and dNTP is a deoxynucleoside triphosphate ([dATP](#), [dCTP](#), [dUTP](#), [dGTP](#), or [dTTP](#)).

NDPK uses energy of ATP to make triphosphates of ribonucleoside diphosphates and deoxyribonucleoside diphosphates in both *de novo* and salvage biosynthesis.

See also: [De Novo Biosynthesis of Purine Nucleotides](#), [De Novo Pyrimidine Nucleotide Metabolism](#), [Nucleotide Salvage Synthesis](#), [Salvage Routes to Deoxyribonucleotide Synthesis](#)

Adenylate Kinase

Adenylate kinase catalyzes the reaction that follows:



This reversible reaction provides both a way for a cell to make ATP from ADP as well as to convert AMP to ADP. A similar reaction is catalyzed by [guanylate kinase](#) (see [here](#) also).

See also: [De Novo Biosynthesis of Purine Nucleotides](#), [Salvage Routes to Deoxyribonucleotide Synthesis](#)

INTERNET LINK: [Crystal Structure of Adenylate Kinase](#)

Unnumbered Item

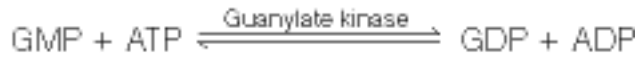

Adenylosuccinate Synthetase



Adenylosuccinate synthetase catalyzes the following reaction in the *de novo* biosynthesis of **AMP**

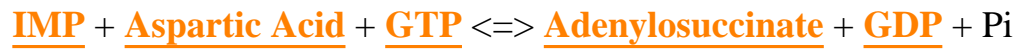

See also: [Figure 22.6, De Novo Biosynthesis of Purine Nucleotides](#)

Adenylosuccinate

Adenylosuccinate is an intermediate in *de novo* biosynthesis of **AMP** (**Figure 22.6**). **Adenylosuccinate** is involved in the reactions shown below.

1. **IMP** + **Aspartic Acid** + **GTP** \rightleftharpoons **Adenylosuccinate** + **GDP** + Pi
(catalyzed by **Adenylosuccinate Synthetase**)

2. **Adenylosuccinate** \rightleftharpoons **Fumarate** + **AMP** (catalyzed by **Adenylosuccinate Lyase**)

See also: **De Novo Biosynthesis of Purine Nucleotides**

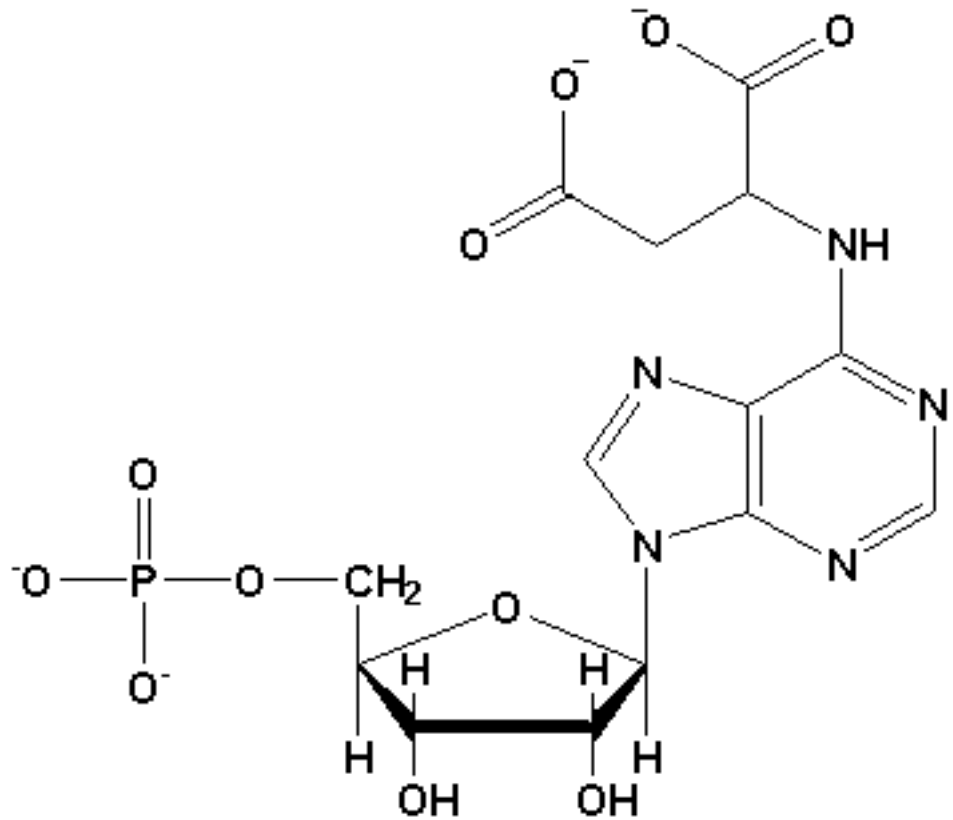

Adenylosuccinate

Adenylosuccinate Lyase



Adenylosuccinate lyase catalyzes the following reaction in the *de novo* biosynthesis of **AMP**

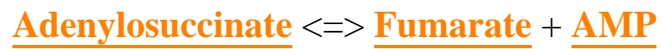

See also: **Figure 22.6, De Novo Biosynthesis of Purine Nucleotides**

IMP Dehydrogenase

IMP dehydrogenase catalyzes the reaction that follows:

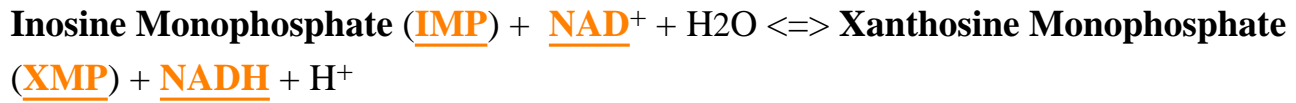

The reaction is part of the *de novo* biosynthetic pathway of purines. **IMP dehydrogenase** is allosterically inhibited by **GMP**, the end product of the pathway.

See also: [Figure 22.6, *De Novo* Biosynthesis of Purine Nucleotides](#)

INTERNET LINKS:

1. [Purine Metabolism](#)
 2. [Purine and Pyrimidine Metabolism](#)
-

Xanthosine Monophosphate (XMP)

XMP is an intermediate in the *de novo* biosynthesis of **GMP** ([Figure 22.6](#)). It is acted on by the enzyme **IMP dehydrogenase**, as follows:

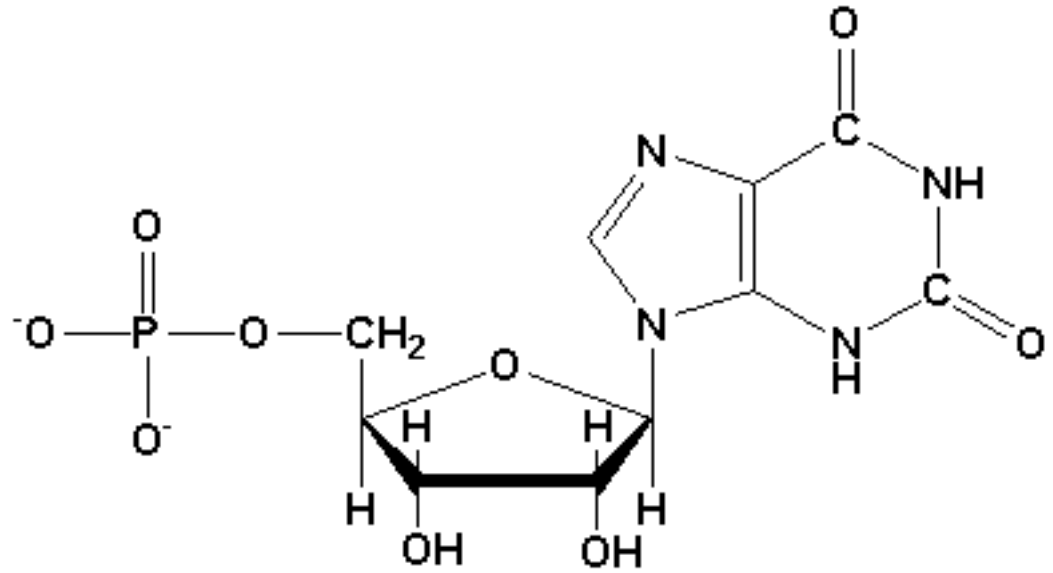

Xanthosine Monophosphate

Inosine Monophosphate (IMP) + **NAD⁺** + H₂O \rightleftharpoons **Xanthosine Monophosphate (XMP)** + **NADH** + H⁺

Subsequently, **XMP** is converted to **GMP** by the enzyme **XMP aminase** ([Figure 22.6](#)).

See also: [De Novo Biosynthesis of Purine Nucleotides](#)

AMP Deaminase

AMP Deaminase is an enzyme in purine catabolism that deaminates AMP to form IMP and ammonia, as follows:

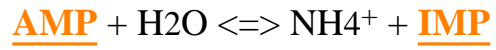

See also: [Figure 22.7, Purine Degradation](#)

Figure 22.7: Catabolism of purine nucleotides to uric acid.

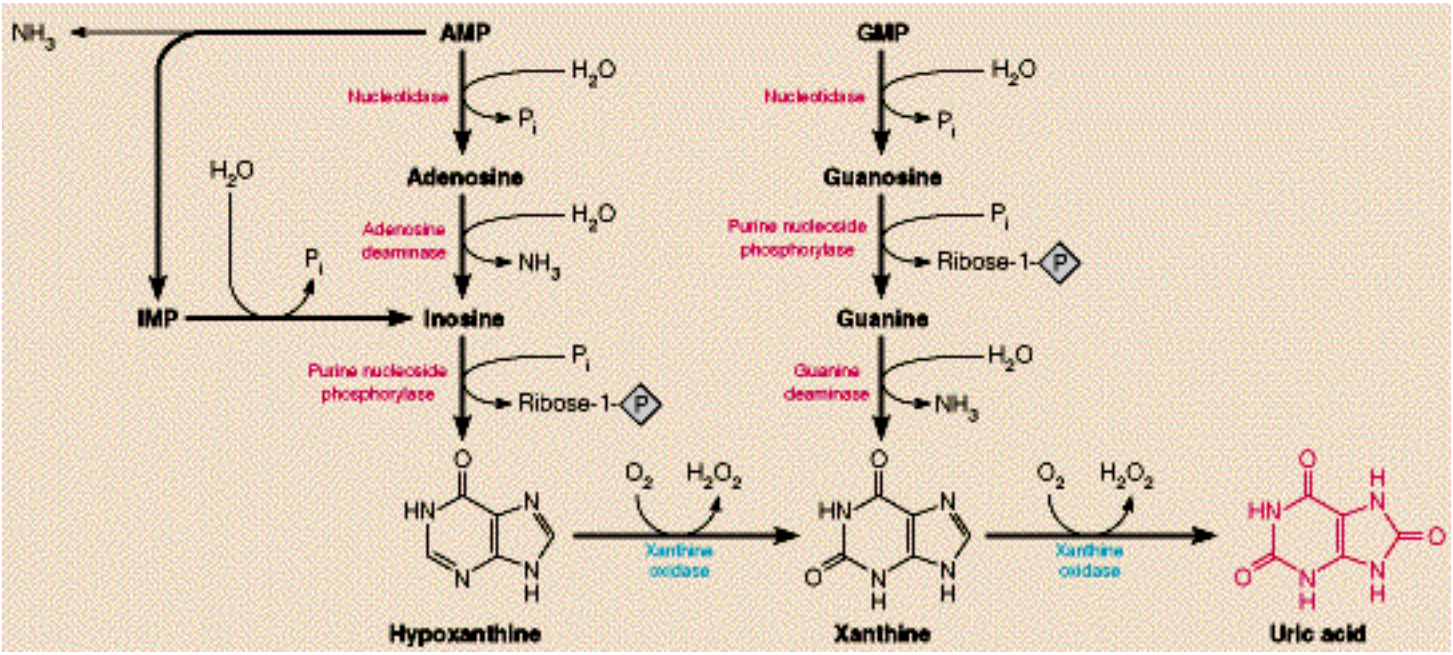

Purine Degradation

Figure 22.7 shows pathways of purine catabolism leading to **uric acid**. As seen in the figure, **AMP** and **GMP** can both be hydrolyzed from their phosphates by **nucleotidase**, ultimately yielding the bases **hypoxanthine** and **xanthine**, respectively. Hypoxanthine is converted to xanthine by **xanthine oxidase** and xanthine is converted to **uric acid**, also by xanthine oxidase. In addition, AMP can be degraded first in a deamination to form **IMP**, which loses its phosphate to become **inosine**. Inosine, in turn, is converted to hypoxanthine.

Uric acid, the end point of purine degradation in primates, is excreted. Most other animals, however, oxidize uric acid to **allantoin**, hydrolyze allantoin to **allantoic acid** and subsequently convert allantoic acid to **urea** or other possible excretion products, depending on the animal (**Figure 22.8**).

See also: [Excessive Uric Acid in Purine Degradation](#), [Lesch-Nyhan Syndrome](#), [Immunodeficiency and Defective Purine Catabolism](#)

INTERNET LINKS:

1. [Purine Metabolism](#)
 2. [Purine and Pyrimidine Metabolism](#)
-

Sialic Acid

Sialic acid is a name for a group of compounds derived from or related to **N-acetylneuraminic acid**. **Sialic acids** are found in **glycoproteins**, gangliosides, and glycolipids. Sialic acid is activated for addition to a growing glycoprotein by reaction with CTP as follows:

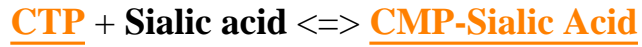

See also: **Glycoproteins**, **Figure 9.29**, **Figure 16.14**, **Figure 19.14**

N-Acetyl-Neuraminic Acid

N-Acetyl-neuraminic acid is a component of **glycoproteins** and glycolipids. **N-Acetyl-neuraminic acid** and its derivatives are collectively referred to as **sialic acids**.

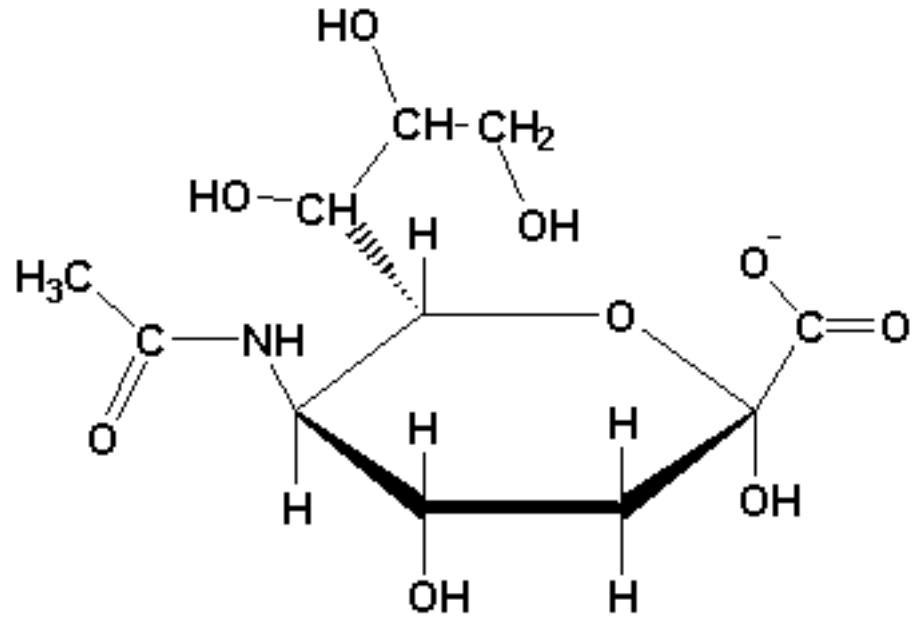

N-Acetyl-Neuraminic Acid

See also: [Glycoproteins](#), [Figure 9.29](#), [Figure 16.14](#), [Figure 19.14](#)

N-Acetylgalactosamine

N-acetylgalactosamine is a constituent of [glycosaminoglycans](#) and O-linked glycoproteins.

Glycosaminoglycans - Glycosaminoglycans are heteropolysaccharides containing either **N-acetylgalactosamine** or N-acetylglucosamine as one of their monomeric units. Examples include [chondroitin sulfates](#) and [keratan sulfates](#) of connective tissue, [dermatan sulfates](#) of skin, and [hyaluronic acid](#). All of these are acidic, through the presence of either sulfate or carboxylate groups ([Figure 9.23](#)).

O-Linked Glycoproteins - The most common O-linkage in glycoproteins involves a terminal **N-acetylgalactosamine** residue in the oligosaccharide linked to a [serine](#) or [threonine](#) residue of the protein ([Figure 9.28](#)).

N-acetylgalactosamine is a component of the ABO blood group antigens ([Figure 9.29](#)). The presence of **N-acetylgalactosamine** on the end of the oligosaccharide gives a person type A blood.

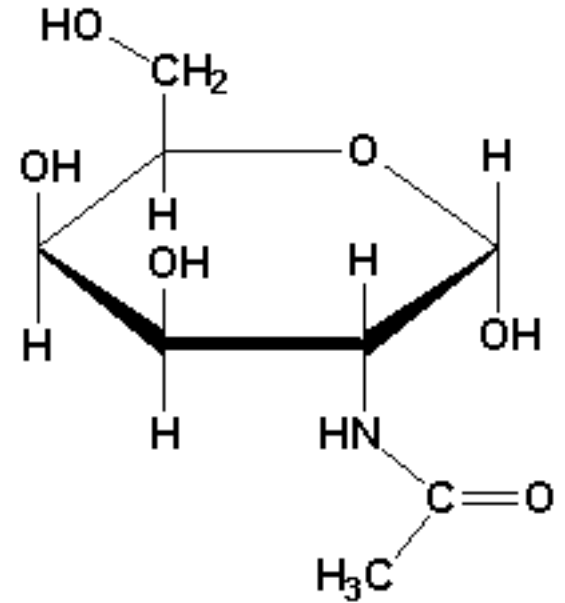

N-Acetylgalactosamine

See also: [Biosynthesis of Glycoconjugates](#), [Glycoproteins](#) (from Chapter 9), [Glycosaminoglycans](#), [Hyaluronic Acid](#), [Structural Polysaccharides](#), [UDP-N-Acetylgalactosamine](#)

Uronic Acids

Uronic acid is a name for a class of compounds made by converting the primary alcohol group of an aldose (terminal carbon away from aldehyde group) to a carboxyl group. Common **uronic acids** include **D-glucuronic acid** (shown at right), **D-galacturonic acid**, and **D-mannuronic Acid**. **Uronic acids** are substituents in glycosaminoglycans.

See also: **Glycosaminoglycans**

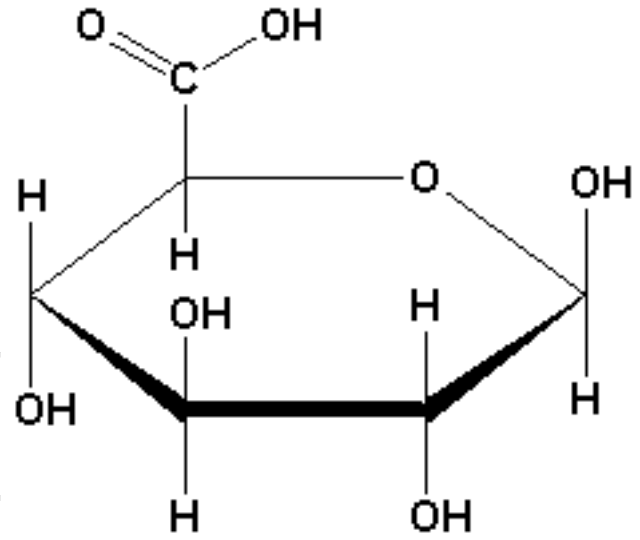

Glucuronic Acid

Glucuronic Acid

Heme Degradation - Erythrocytes have a lifetime of about 120 days. Aged erythrocytes are destroyed upon passage through the spleen or liver ([Figure 21.31](#)). The basic pathway of heme breakdown is:

Heme -> [Biliverdin](#) -> [Bilirubin](#) -> (passage through blood to liver as bilirubin-albumin complex) -> [Bilirubin diglucuronide](#) -> excretion.

Bilirubin is insoluble in aqueous solutions, so complexing with albumin and [glucuronic acid](#) is essential for passage through the body. Accumulation of bilirubin in the blood leads to jaundice.

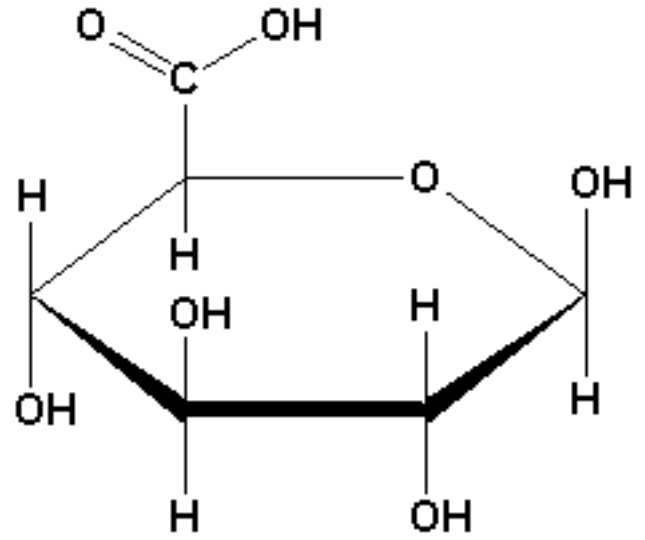

Glucuronic Acid

See also: [Uronic acids](#), [hyaluronic acid](#), [bilirubin](#), [UDP-Glucuronate](#)

Figure 21.31: Catabolism of heme.

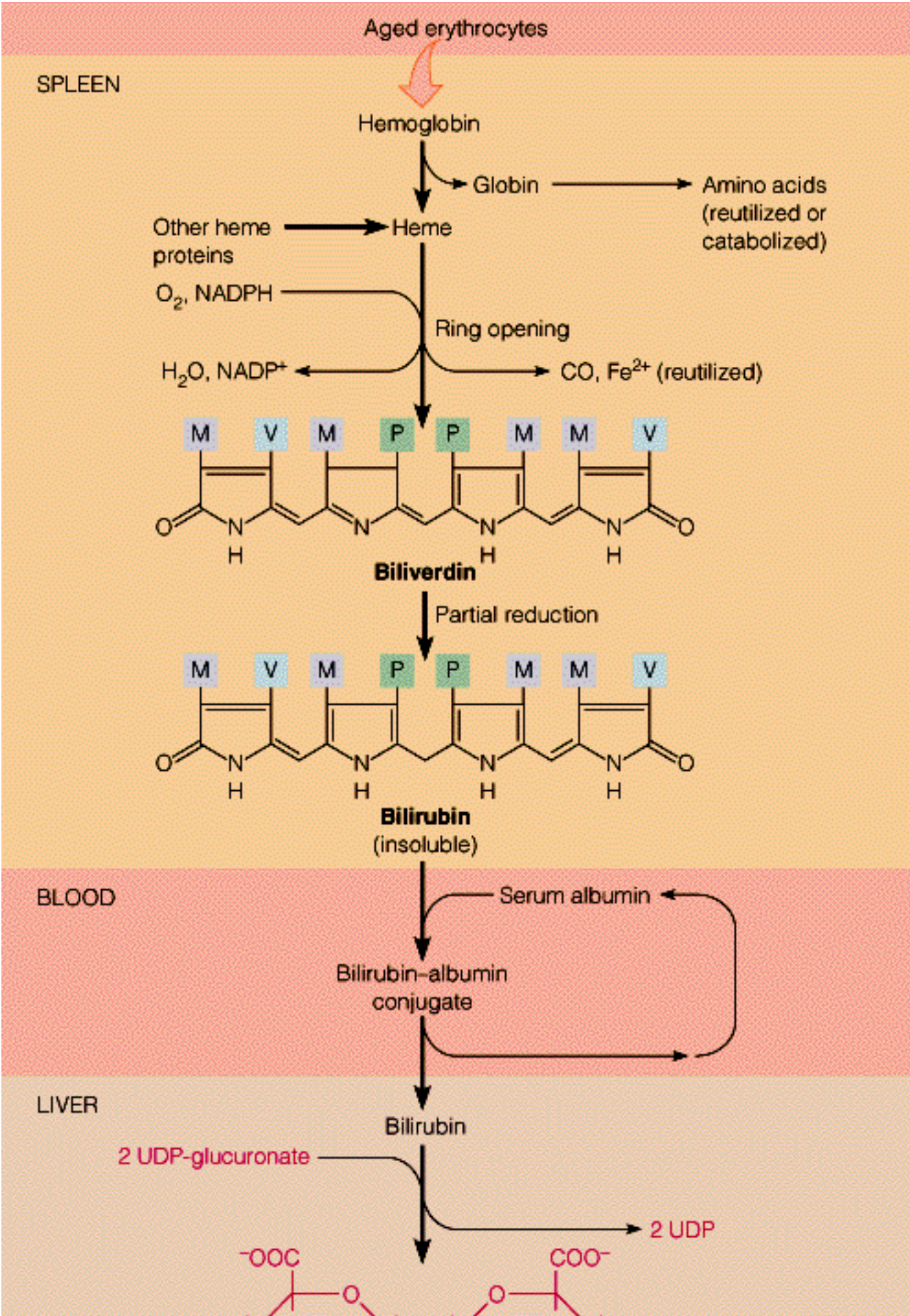

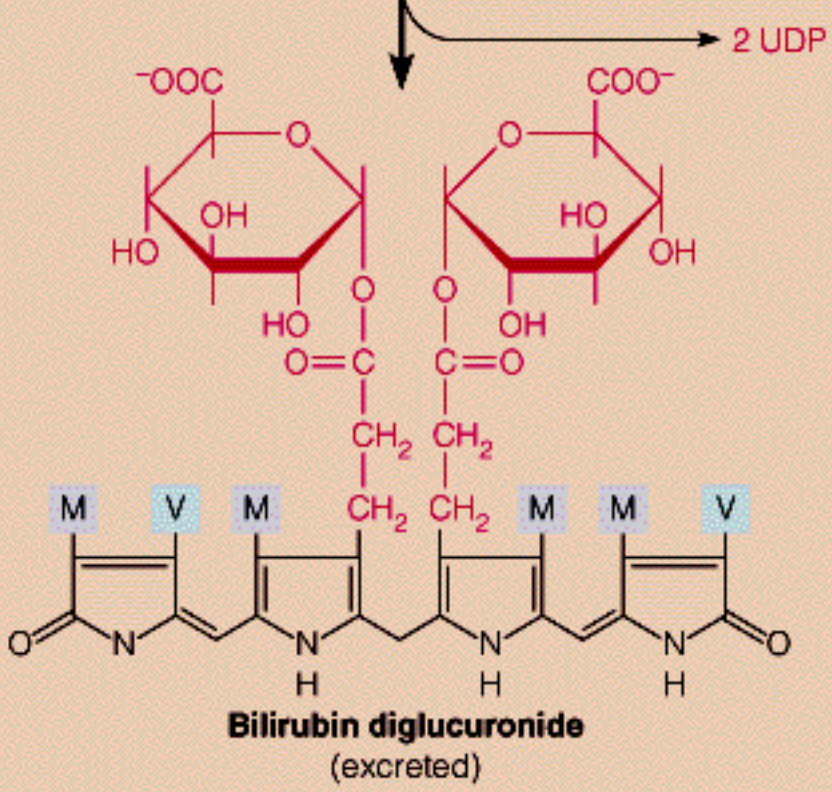

Biliverdin

Biliverdin is a product of the catabolism of **heme** (**Figure 21.31**).

Amino acids released from the globin portion of the **hemoglobin**

molecule are catabolized

or reused for protein synthesis. The heme portion undergoes degradation, starting with a mixed-function oxidase reaction that opens the ring and converts one of the methene bridge carbons to carbon monoxide. Iron is released from the resulting linear tetrapyrrole, called **biliverdin**, and is transported to storage pools in bone marrow for reuse in erythrocyte production. The tetrapyrrole is next reduced to **bilirubin**, which is excreted.

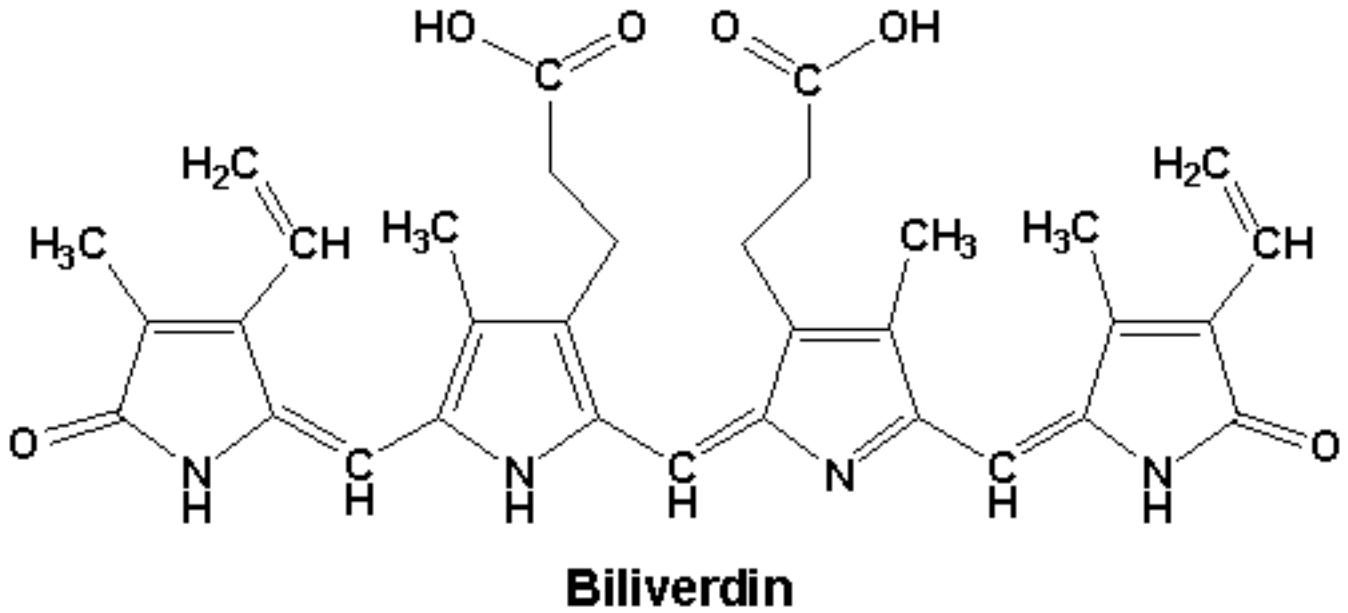

See also: [Porphyrin and Heme Metabolism](#)

INTERNET LINKS:

1. [Porphyrin and Chlorophyll Metabolism](#)
 2. [Photosynthetic Pigments](#)
-

Bilirubin

Bilirubin is produced from **biliverdin** in catabolism of the **heme** of **hemoglobin**.

These reactions, which occur in the spleen (**Figure 21.31**), yield **bilirubin**, which is quite insoluble in water, and must

be removed by several organ systems. First, **bilirubin** complexes with serum albumin for transport to the liver. There, it is solubilized by conjugation with two molecules of **glucuronic acid**. The reaction is comparable to other glycosyltransferase reactions, with the substrate being **UDP-glucuronate**. This solubilized compound, **bilirubin diglucuronide**, is secreted into the bile and ultimately excreted via the intestine. Defects in metabolizing **bilirubin** properly give rise to jaundice.

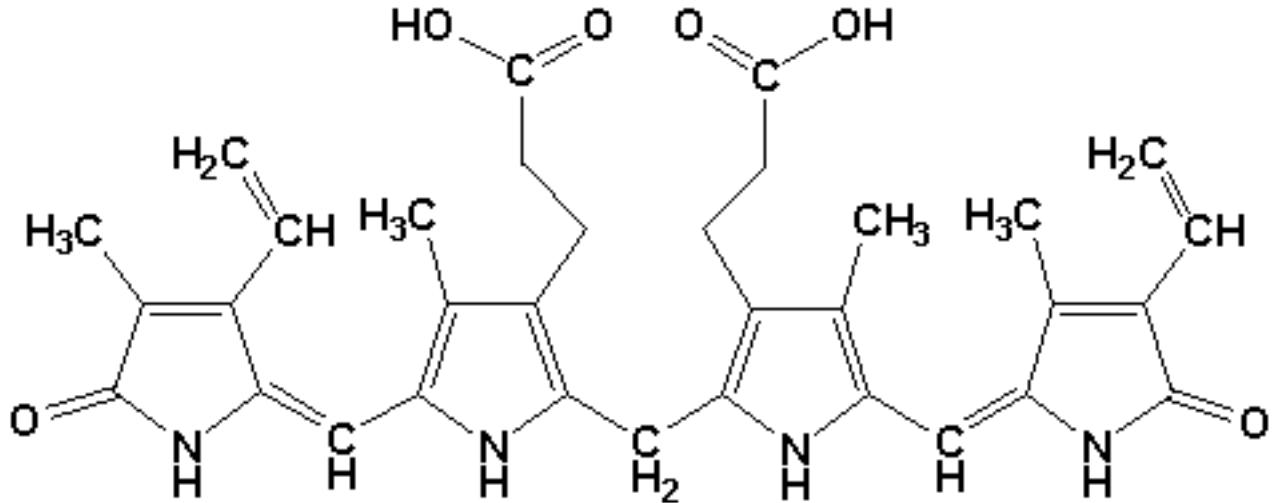

Bilirubin

See also: [Serum Albumin](#), [Porphyrin and Heme Metabolism](#)

INTERNET LINKS:

1. [Porphyrin and Chlorophyll Metabolism](#)
 2. [Photosynthetic Pigments](#)
-

Bilirubin Diglucuronide

Bilirubin diglucuronide is a metabolite of bilirubin made by conjugating it with two molecules of glucuronic acid ([Figure 21.31](#)).

This reaction, which helps make the relatively insoluble bilirubin much more water soluble, occurs in the liver. After conversion,

bilirubin diglucuronide is

secreted into the bile and is ultimately excreted via the intestine. The pathway of heme breakdown in the body is as follows:

Heme -> **Biliverdin** -> **Bilirubin** -> (passage through blood to liver as bilirubin-albumin complex) -> **Bilirubin diglucuronide** -> excretion.

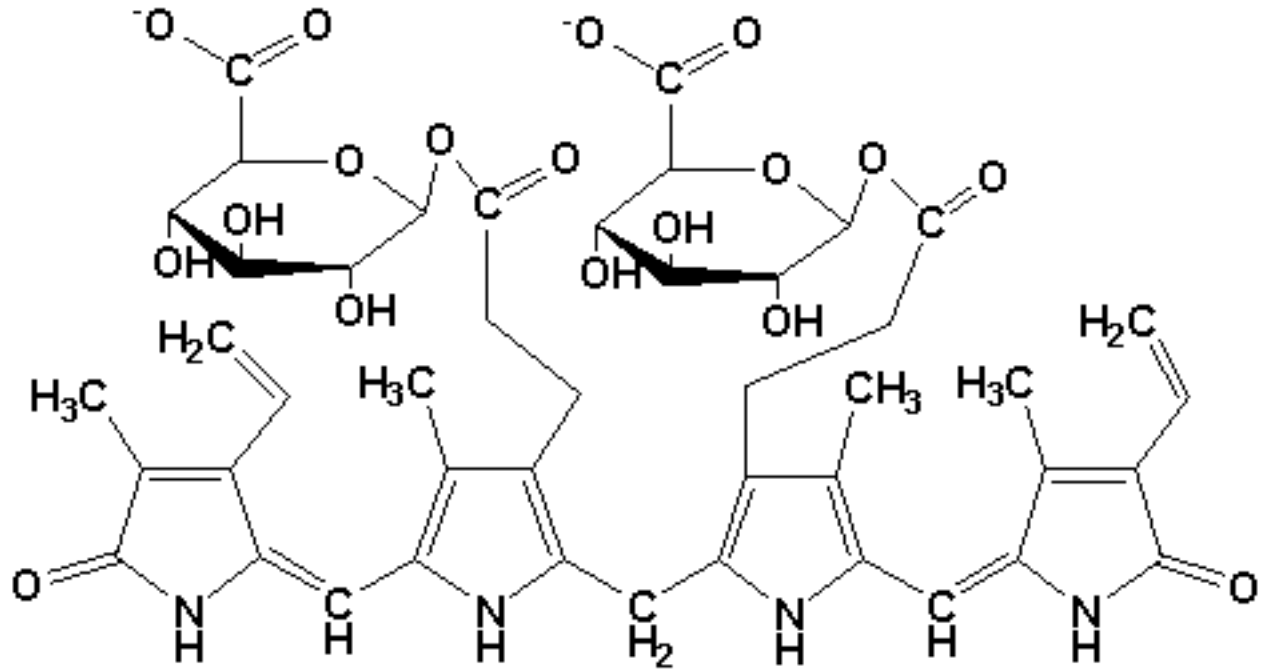

Bilirubin Diglucuronide

See also: [Porphyrin and Heme Metabolism](#), [Glucuronic Acid](#)

INTERNET LINK: [Porphyrin and Chlorophyll Metabolism](#)

Porphyrin and Heme Metabolism

A major metabolic fate of **glycine** is the biosynthesis of tetrapyrroles, compounds which contain four linked pyrrole rings. Four classes of these compounds include 1) **Heme** (an iron porphyrin); 2) **Chlorophylls**; 3) Phycobilins (photosynthetic pigments of algae; and 4) Cobalamins (**Vitamin B12** and derivatives).

All tetrapyrroles are synthesized from δ -**aminolevulinic acid (ALA)**. Relationships between the various pathways are shown in **Figure 21.27**.

Heme synthesis:

1. All of the nitrogen in **heme** is derived from glycine and all of the carbons are derived from succinate and glycine. Thus, the process by which heme is synthesized is also called the succinate-glycine pathway. The first step in the process is catalyzed by a **pyridoxal phosphate**-containing enzyme, δ -**aminolevulinic acid synthetase (ALA synthetase)** (**Figure 21.28**). In plants, ALA is made via a process that begins with **glutamate**, which becomes linked to a molecule of tRNA (**Figure 21.29**). In plants, synthesis of ALA is regulated by light.
2. The next step is the synthesis of a substituted pyrrole compound, **porphobilinogen** from ALA (see **here**).
3. The four porphobilinogen molecules condense to yield a **porphyrinogen** (**Figure 21.30**).
4. Finally, the side chains are modified and the ring system is dehydrogenated (**Figure 21.30**).

Note that **uroporphyrinogen III** is an asymmetric compound. It arises from action of uroporphyrinogen I synthase and uroporphyrinogen III cosynthase. If only the first enzyme is active, the symmetric compound, **uroporphyrinogen I** is produced. In the hereditary condition called congenital erythropoietic porphyria, the uroporphyrinogen III cosynthase is defective and the symmetric type I porphyrins accumulate, causing the urine to turn red, the skin to become photosensitive, and the teeth to become fluorescent. Because insufficient heme is produced, anemia results.

The major regulatory step in heme synthesis is the ALA synthetase reaction. Through feedback inhibition, heme regulates the enzyme. Heme also inhibits the translation of ALA synthetase. At even higher levels, heme blocks transport of ALA synthetase to the mitochondrion - its site of action.

Heme degradation - Erythrocytes have a lifetime of about 120 days. Aged erythrocytes are destroyed upon passage through the spleen or liver ([Figure 21.31](#)). The basic pathway of heme breakdown is the following:

Heme -> [Biliverdin](#) -> [Bilirubin](#) -> (passage through blood to liver as bilirubin-albumin complex) -> [Bilirubin Diglucuronide](#) -> excretion.

Bilirubin is insoluble in aqueous solutions, so complexing with [albumin](#) and [glucuronic acid](#) is essential for passage through the body. Accumulation of bilirubin in the blood leads to jaundice.

See also: [Light Absorbing Pigments](#) (from Chapter 17)

INTERNET LINKS:

1. [Porphyrin and Chlorophyll Metabolism](#)
 2. [Photosynthetic Pigments](#)
-

Chloroplast Anatomy

In all higher plants and algae, photosynthetic processes are localized in organelles called **chloroplasts** ([Figure 12.11](#)). In plants, most of the **chloroplasts** are found in cells just under the leaf surface (mesophyll cells). Each cell may contain 20 to 50 of these organelles ([Figure 17.4c](#)). The eukaryotic algae also have **chloroplasts**, but often only one very large one is found in each cell.

The internal structure of a **chloroplast**, as shown in [Figure 17.4c](#), bears some resemblance to that of a mitochondrion. There is an outer, freely permeable membrane and an inner membrane that is selectively permeable. The inner membrane encloses a material called the stroma that is analogous to the mitochondrial matrix. Immersed in the stroma are many flat, saclike membrane structures called thylakoids, which are often stacked like coins to form units called grana (see [Figure 17.4c](#)). Individual grana are irregularly interconnected by thylakoid extensions called stroma lamellae. The thylakoid membrane encloses an interior space, the lumen of the thylakoid.

The division of labor within a **chloroplast** is simple. Absorption of light and all of the light reactions occur within or on the thylakoid membranes. The ATP and NADPH produced by these reactions are released into the surrounding stroma, where all of the synthetic dark reactions occur. Obviously, there are analogies in structure and role between mitochondrial matrix and chloroplast stroma and between the inner membrane of the mitochondrion and the thylakoid membrane of the chloroplast. Indeed, we shall find that a very similar kind of chemiosmotic ATP generation is carried out across these membranes in both mitochondria and **chloroplasts**.

Like mitochondria, **chloroplasts** are semiautonomous, carrying their own DNA to code for some of their proteins, as well as the ribosomes necessary for translation of the appropriate messenger RNAs. There is now much evidence that **chloroplasts** evolved from unicellular organisms similar to cyanobacteria (blue-green algae). Such prokaryotic photosynthesizers do not contain **chloroplasts** but have membrane structures that play the same roles as chloroplast membranes. To a certain extent, the cyanobacteria resemble free-living **chloroplasts**. It is believed that, early in evolution, primitive unicellular organisms took up cyanobacteria-like prokaryotes and that eventually the relationship became symbiotic: The photosynthetic organelles were no longer capable of independent life, and the algae depended upon them as energy sources. Today, some chloroplast genes are coded in the organelle genome, and some are in the cell nucleus.

See also: [Stroma](#), [Grana](#), [Lumen of the Thylakoid](#), [Thylakoid Membranes](#), [Chlorophyll](#), [CF0-CF1 Complex](#)

INTERNET LINKS:

1. [Chloroplast Genome Page](#)

2. [Complete Chloroplast Genome Sequences](#)

Figure 12.11: Locations of major metabolic pathways within a eukaryotic cell.

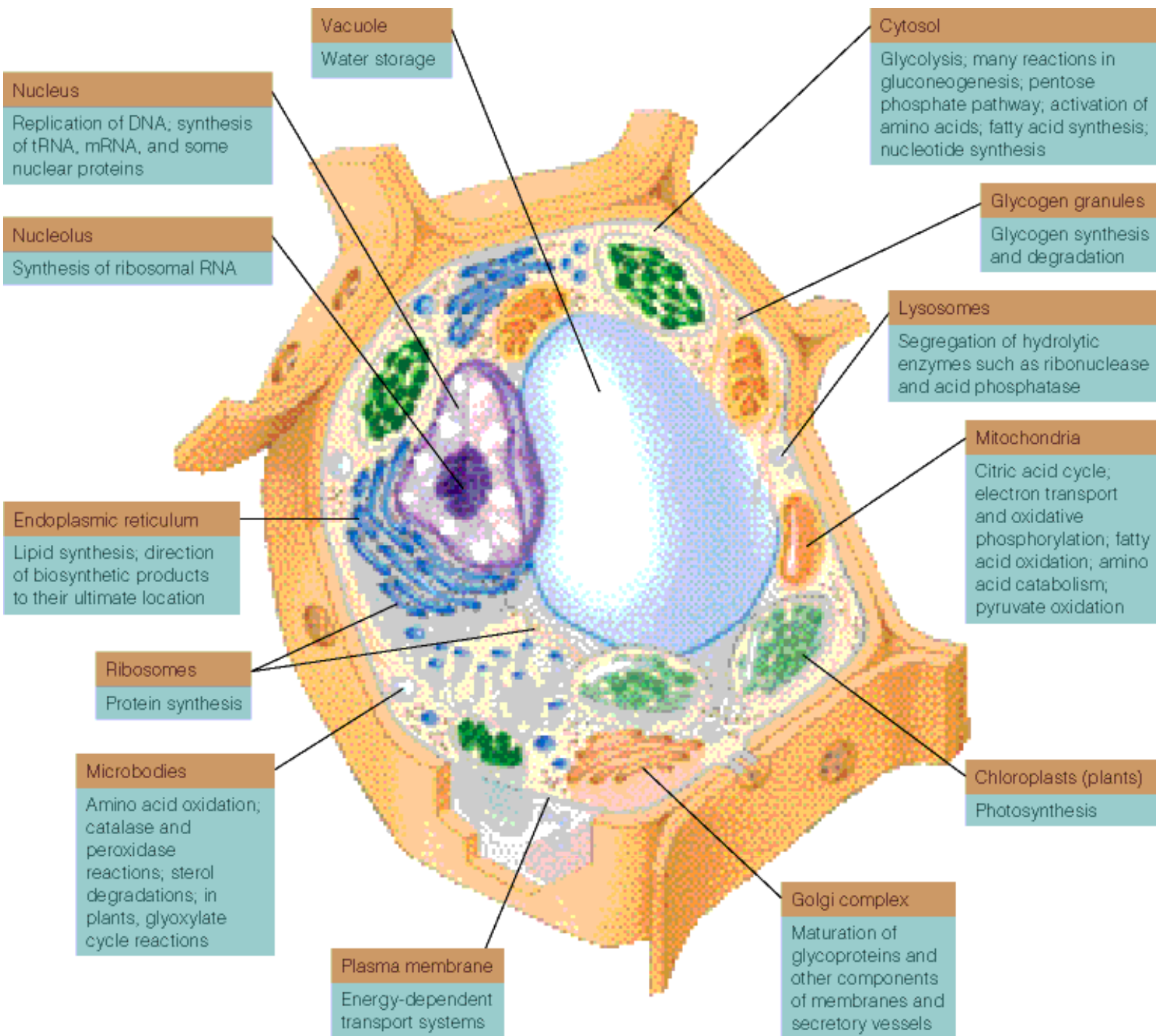

Stroma

The **stroma** is a chloroplast structure that is equivalent to the matrix of the mitochondria ([Figure 15.2a](#)). It consists of the space surrounding the grana in the organelle ([Figure 17.4c](#)). In photosynthesis, protons are pumped out of the **stroma** into the thylakoid lumen of the grana to form a proton gradient. The gradient is used as an energy source by the CF₀-CF₁ complex to make ATP.

[ATP](#) and [NADPH](#) produced by the photosystems on the thylakoids during photosynthesis are released into the surrounding **stroma**, where all of the synthetic dark reactions ([Calvin cycle](#)) occur.

See also: [Thylakoids](#), [Thylakoid Lumen](#), [CF₀-CF₁ Complex](#), [Chloroplast Anatomy](#), [The Chloroplast](#), [Thylakoid Membrane](#), [Grana](#), [Photosystem I](#), [Photosystem II](#), [Mitochondrial Structure and Function](#)

CF₀-CF₁

The **CF₀-CF₁ complex** is the ATP synthase complex of the [chloroplast](#) that functions similarly to the F₀F₁ complex of mitochondria. It is located in the [thylakoid membranes](#), as shown in [Figure 17.15](#). During photosynthesis, electrons are pumped into the [thylakoid lumen](#) from the [stroma](#), forming a proton gradient. Movement of the protons out of the thylakoid lumen through the **CF₀-CF₁ complex** back to the stroma provides the driving force for photophosphorylation, the process of making ATP in photosynthesis. A similar mechanism is responsible for ATP synthesis in [oxidative phosphorylation](#).

See also: [Chloroplast Anatomy](#), [Photosystem Summary](#)

Figure 21.1: Metabolic relationships among amino acids derived from citric acid cycle intermediates.

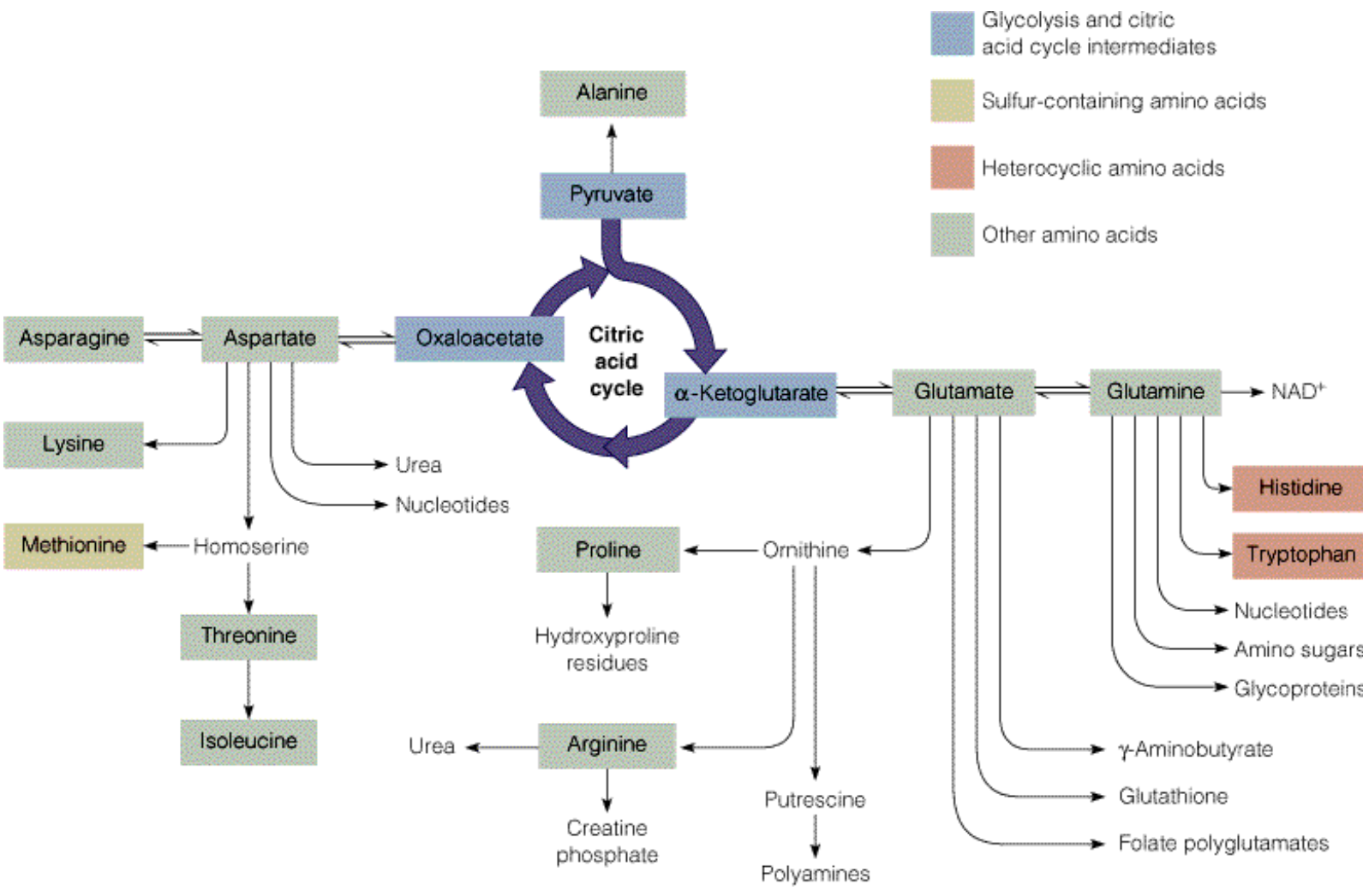

Grana

Grana are structures within chloroplasts consisting of stacks of flat, membrane structures (thylakoids). **Grana** appear as if they were stacks of coins inside the chloroplasts ([Figure 17.4c](#)).

The interior membrane layers of the **grana** are rich in photosystem II; by contrast, the stroma lamellae (structures that connect grana) are rich in photosystem I ([Figure 17.16](#)).

See also: [Chloroplast Anatomy](#), [Stroma](#), [Thylakoid Membrane](#), [The Chloroplast](#), [Thylakoid Lumen](#), [Photosystem II](#), [Photosystem I](#), [Figure 17.12](#)

Photosystem II

Both **photosystem II (PSII)** and photosystem I (PSI) contain an electron transport chain, which extracts energy when an excited electron loses its energy of excitation in a stepwise fashion. The **photosystem** carries out a series of oxidation/reduction reactions similar to those in electron transport. Events in the **photosystem** are as follows:

1. Absorption of a photon by the light harvesting system. The photon is funneled to a **reaction center** chlorophyll designated P680 in **Figure 17.12**.
2. Excitation of P680 raises the molecule from the ground state to an excited state at -0.8 volt.
3. The excited P680 is able to quickly transfer an electron from P680 to a lower-energy primary electron acceptor, such as **pheophytin a** (Ph), shown in **Figure 17.12b**.
4. The electron is transferred to a series of **plastoquinone molecules** (Plastoquinone QA and QB) associated with **PSII** proteins.
5. Two protons are picked up by **QB** and the reduced plastoquinone, **QH₂** (plastoquinol), is released into the lipid portion of the thylakoid membrane. The overall reduction of plastoquinone is shown **here**.
6. Plastoquinol interacts with the membrane-bound cytochrome b6f complex which contains cytochromes and iron-sulfur proteins.
7. The **b6f complex** donates electrons to a copper protein called plastocyanin (PC). The oxidation of plastoquinone results in release of two protons into the thylakoid lumen.

At this point, the electrons are transferred from **PSII** to a P700 reaction center in PSI. **Plastocyanin** is a mobile protein in the **thylakoid lumen**.

Note that b6f plays a role analogous to the cytochrome reductase complex in mitochondria and resembles it closely.

Note also that the P680 has been left in an oxidized state (P680⁺), which is a strong oxidant. P680 recovers electrons from water, which is split in the presence of an electron acceptor, releasing oxygen.

The electron acceptor is a protein containing a cluster of four oxygen-bridged manganese atoms (**Figure**

17.13). The process "dismembers" two water molecules, releasing oxygen, which diffuses out of the chloroplast. The four protons that are produced from the two water molecules are released into the thylakoid lumen, creating a pH gradient between the lumen and stroma.

The reaction summary for **PSII** is shown [here](#).

See also: [Photosystem I](#), [Photosystem Summary](#), [Chlorophyll](#), [Light Harvesting Complex](#), [Figure 17.16](#)

Reaction Center

The **reaction center** is a part of the photosynthetic apparatus in chloroplasts where the photochemical process occurs. **Reaction centers** are a specific pair of chlorophyll molecules in a photosystem that collect light energy absorbed by other chlorophyll molecules in a photosystem and pass it along to an electron acceptor, such as an electron transport chain. The remaining chlorophyll molecules are referred to as antenna molecules of the light-harvesting complexes because they absorb the photons and pass the energy by resonance transfer to the reaction centers. The process occurs on the order of 10^{-10} seconds.

See also: [Light Harvesting Complexes](#)

Light Harvesting Complexes

The first part of the process of recovering energy from photons of light occurs in **light-harvesting complexes** of the chloroplast. Each multisubunit protein complex contains multiple **antenna pigment molecules**, **chlorophylls** and some **accessory pigments**, and two **chlorophyll** molecules that act as the reaction center ([Figure 17.11](#)). The reaction center traps energy quanta excited by the absorption of light.

See also: [Reaction Center](#), [Chloroplasts](#), [Chloroplast Anatomy](#), [Chlorophyll](#), [Figure 17.6](#)

Figure 17.11: Resonance transfer of energy in a light-harvesting complex.

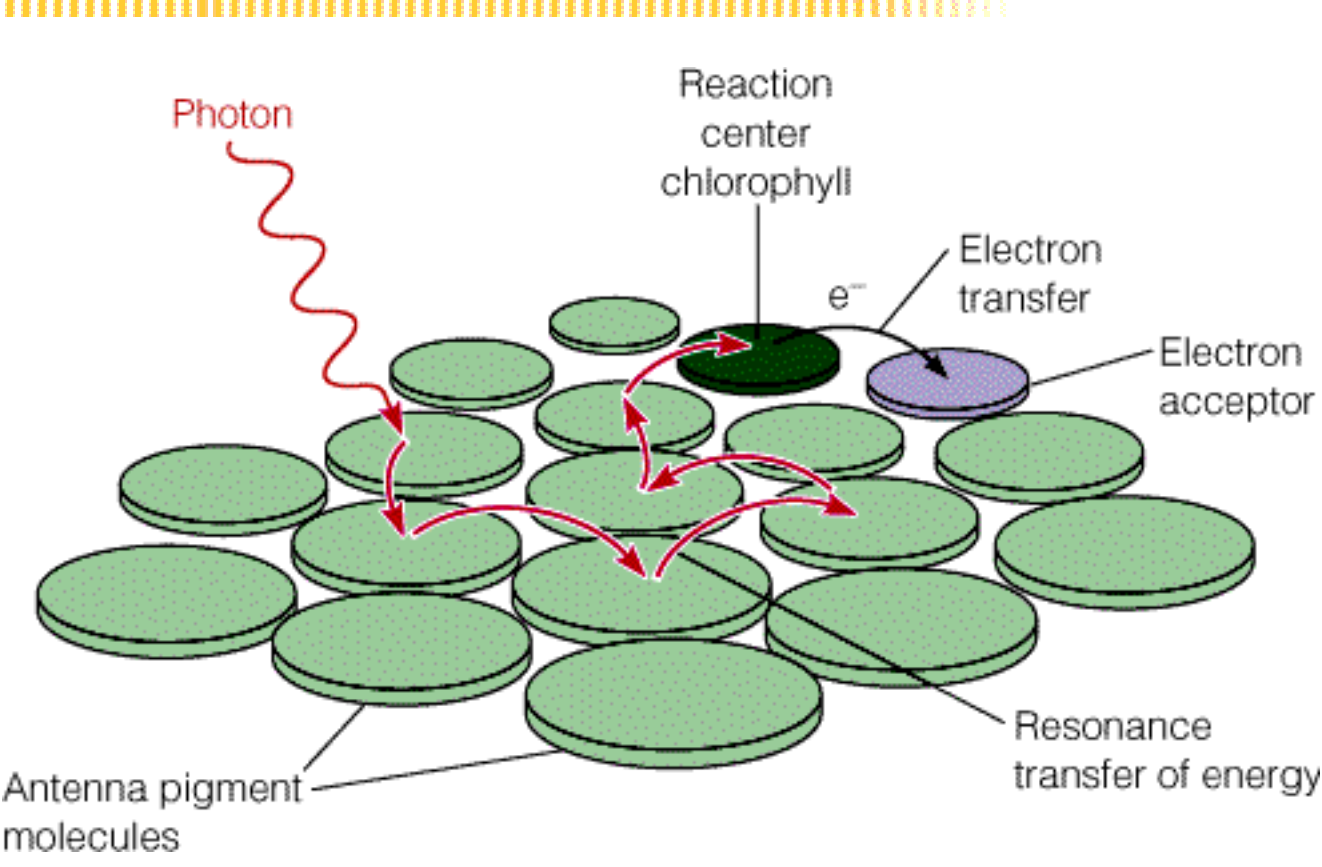

Figure 17.6: The energy of photons.

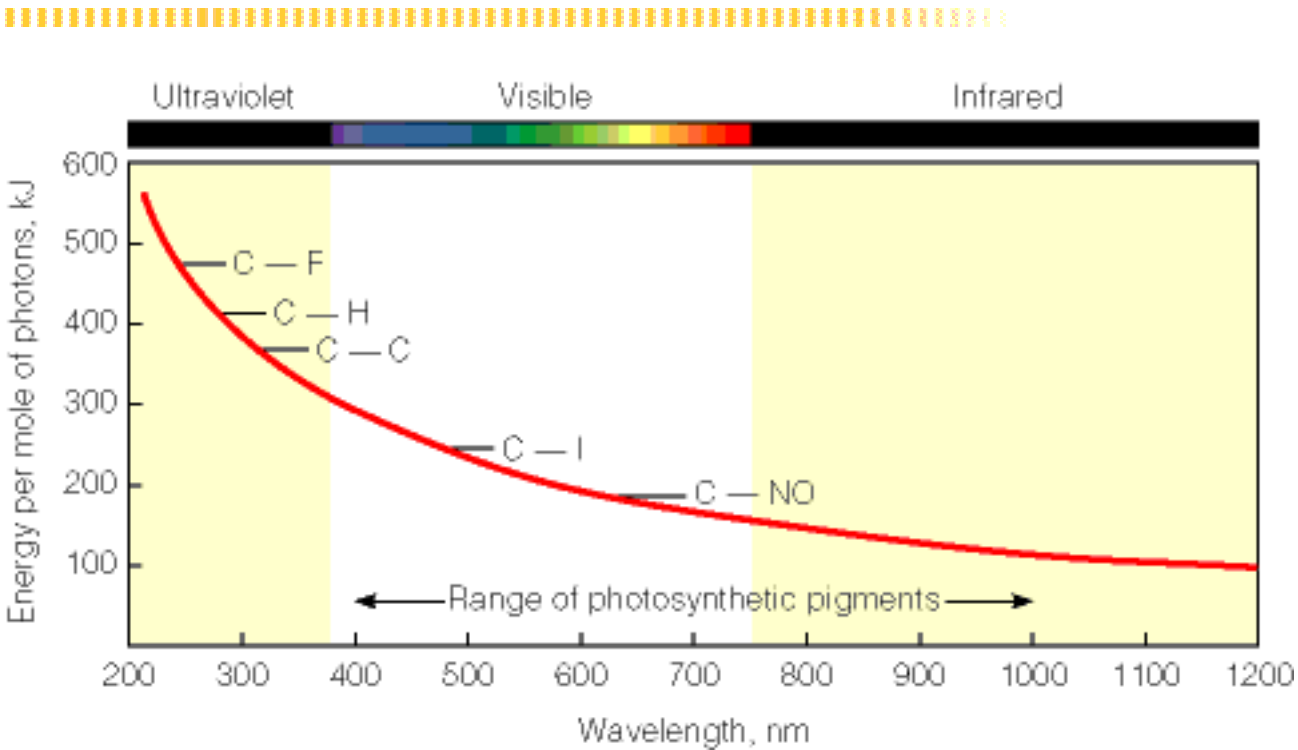
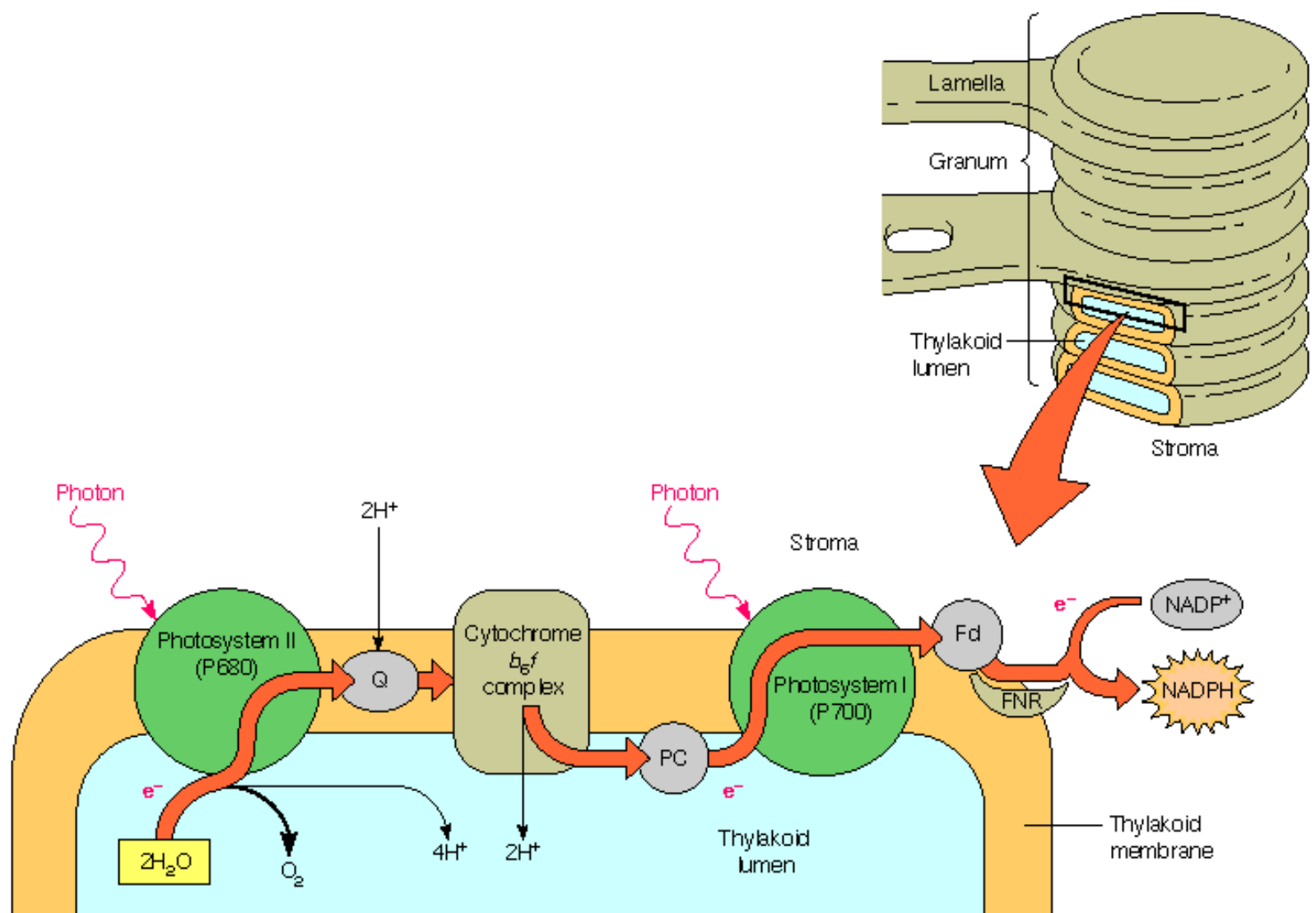
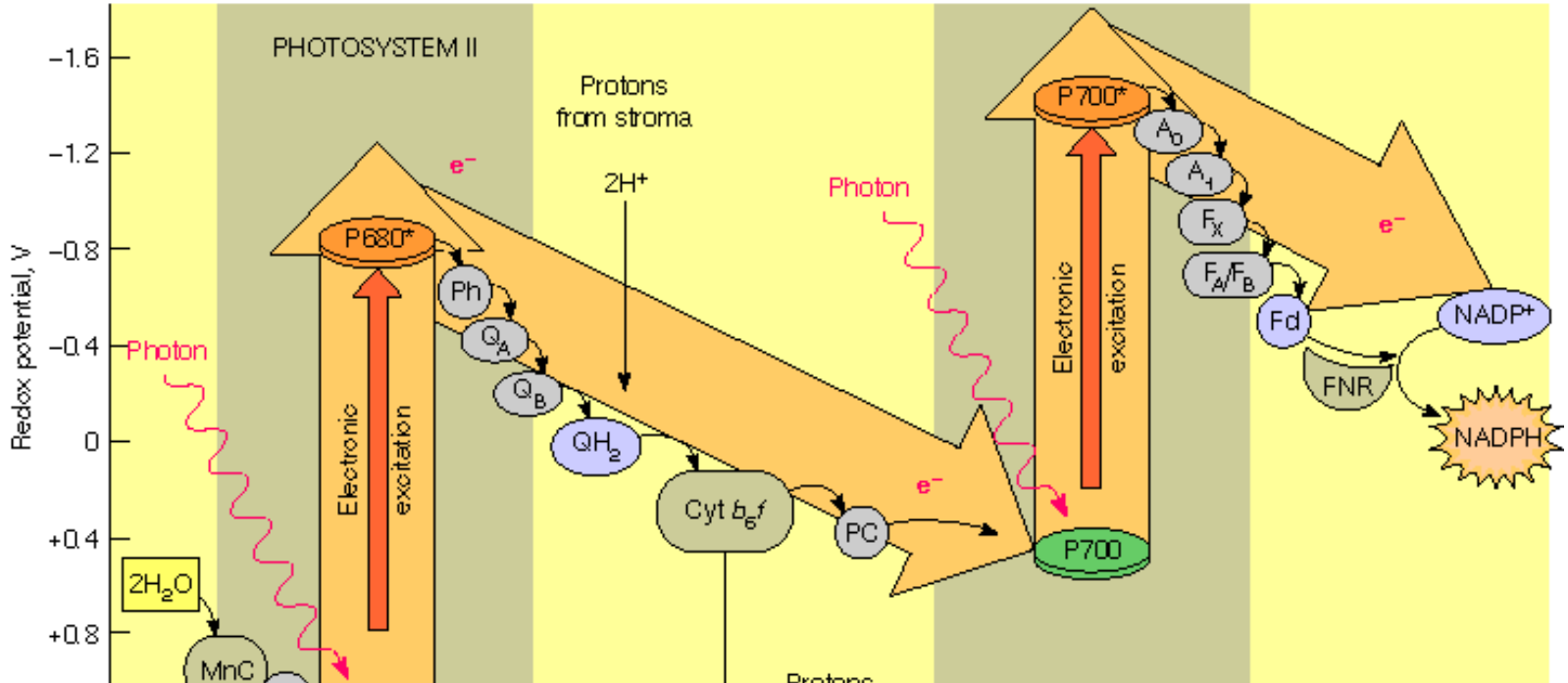
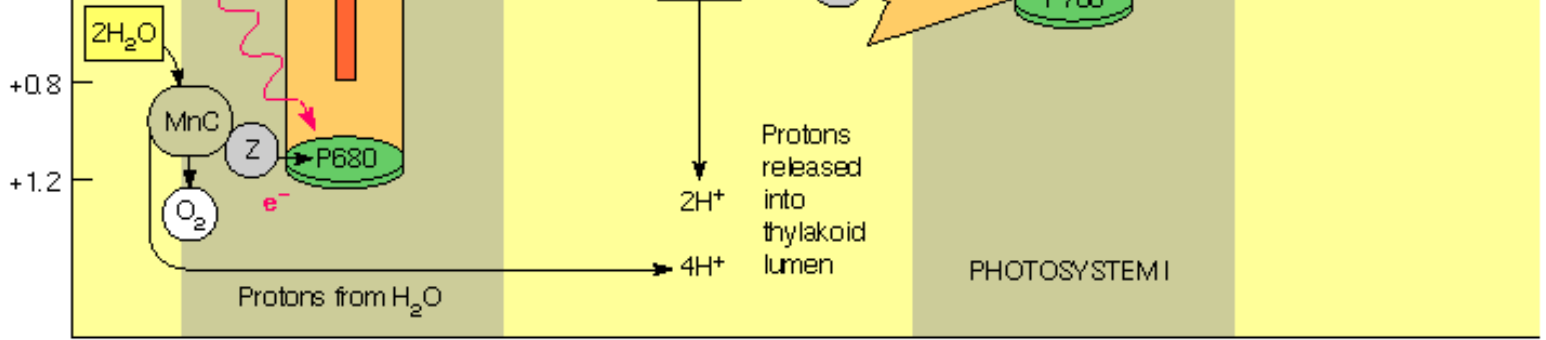

Figure 17.12: The two-photosystem light reactions.



(a)





(b)

Pheophytin

Pheophytins are a group of molecules that serve as electron carriers. They accept excited electrons from photosystem II and pass them to plastoquinone QA ([Figure 17.12](#)).

Pheophytins resemble chlorophyll, except that two protons substitute for the centrally bound magnesium atom.

See also: [Plastoquinones](#),
[Photosystem II](#), [Photosystem I](#), [Plastoquinone QH](#),
[Plastoquinone QA](#),
[Plastoquinone QB](#)

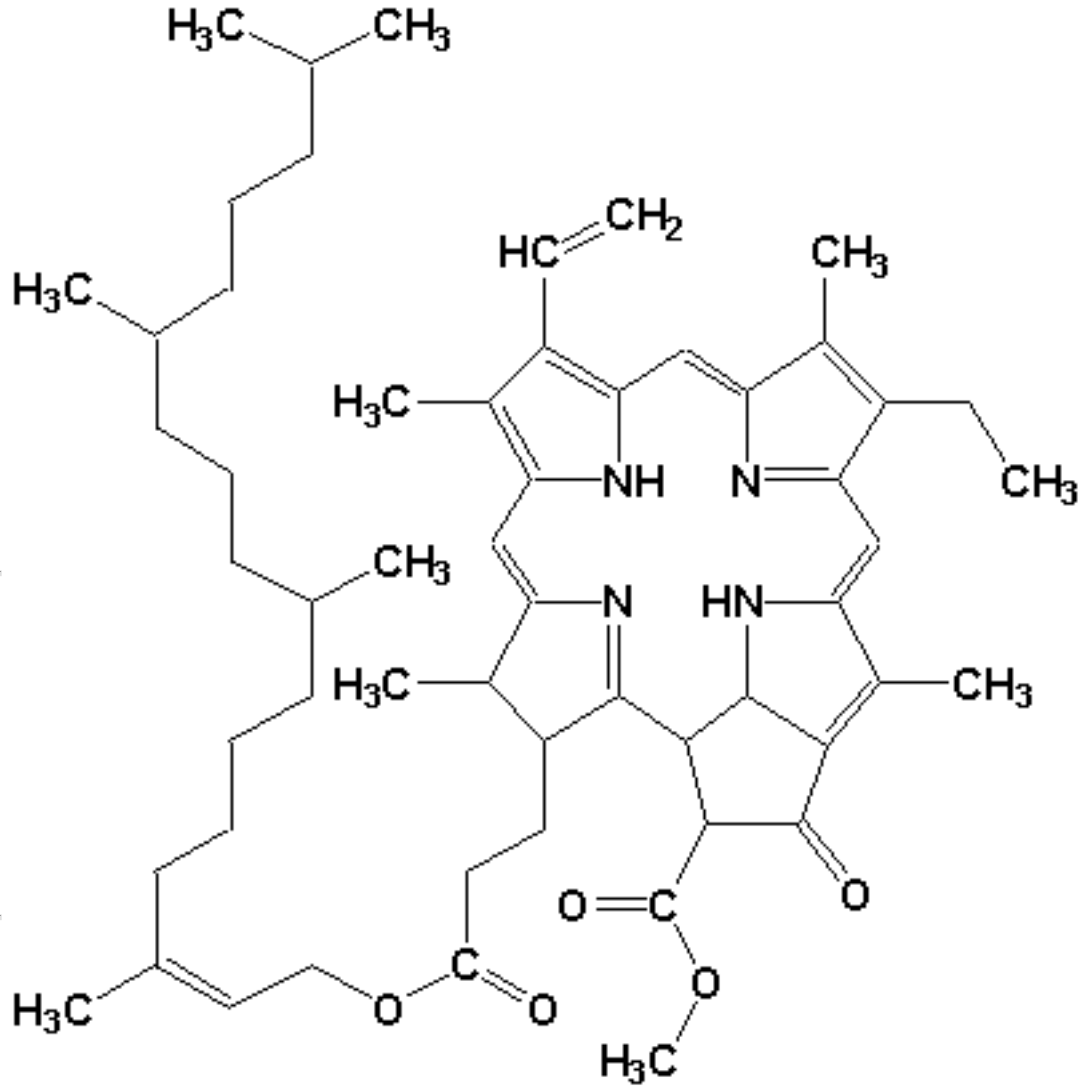

Pheophytin A

Plastoquinones

Plastoquinones are a group of electron transport molecules between photosystem II and photosystem I in plants. The sequence of carriers is as follows: Pheophytin -> QA -> QB -> QH -> Cytochrome b6f, where QA, QB, and QH are the plastoquinones. **Plastoquinone QB** and QA are associated with PSII proteins. Electron transfer involving plastoquinones is shown [here](#). Reduction of a plastoquinone creates a plastoquinol.

See also: [Plastoquinone QH](#), [Pheophytin](#), [Plastoquinone QA](#), [Photosystem II](#), [Photosystem I](#)

Unnumbered Item

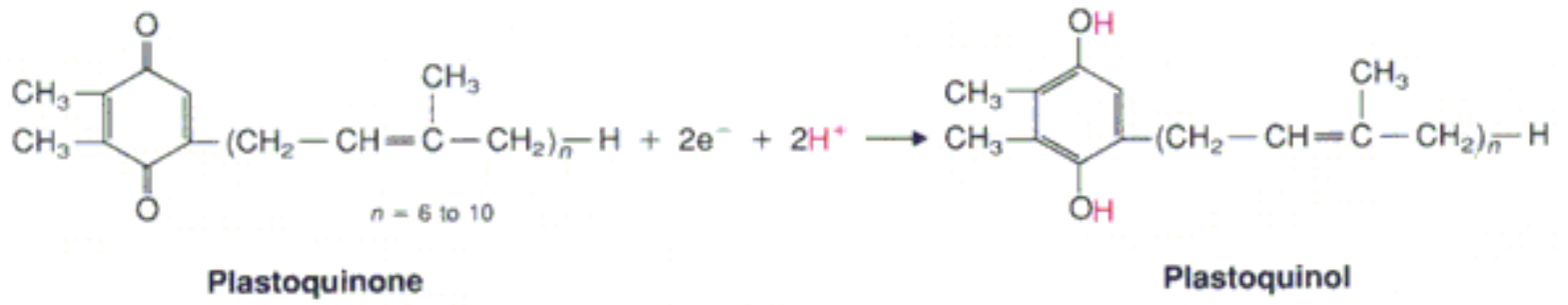

Plastoquinone QH₂

Plastoquinones QH is a molecule in the electron transfer system between photosystem II (PSII) and photosystem I. The sequence of carriers is as follows: Pheophytin -> QA -> QB -> QH -> Cytochrome b6f. **Plastoquinone QH₂** is the photosynthetic equivalent of **coenzyme Q** of the electron transport system. It moves freely in the thylakoid membrane, carry electrons between the photosystem II complex and the cytochrome b6f complex (**Figure 17.12**). Electron transfer involving **plastoquinones** is shown **here**. Reduction of a **plastoquinone** creates a plastoquinol.

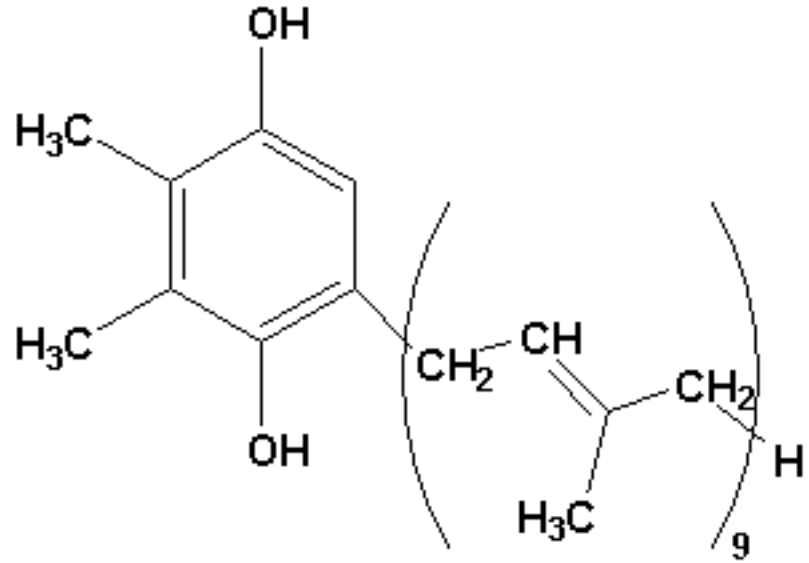

Plastoquinone QH₂

See also: [Plastoquinones](#), [Photosystem II](#), [Photosystem I](#), [Plastoquinone QH](#), [Pheophytin](#), [Plastoquinone QB](#)

Coenzyme Q (CoQ or Ubiquinone)

CoQ is a component of the inner mitochondrial membrane involved in the process of **electron transport**. It draws electrons into the respiratory chain, not only from **NADH** but also from **succinate**, as shown in **Figure 15.3**.

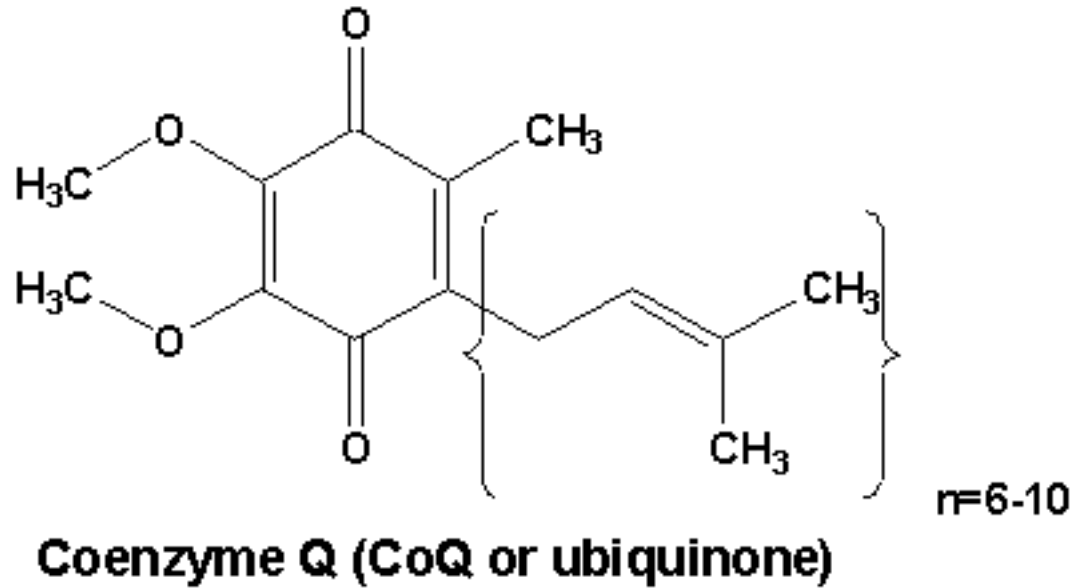

Because **CoQ** is subsequently oxidized by **cytochromes**, it can be seen as a collection point, gathering electrons from several flavoprotein dehydrogenases and passing them along to **cytochromes** for ultimate transport to O₂. Further, since **CoQ** oxido-reduction proceeds one electron at a time through a semiquinone intermediate, **CoQ** provides an interface between two-electron carriers and the one-electron **cytochromes**.

Chorismic Acid is a metabolic precursor in biosynthesis of **CoQ**.

See also: **Figure 21.13**, **Figure 21.14**, **p-Hydroxybenzoic Acid**

Figure 15.3: Respiratory electron carriers in the mitochondrion.

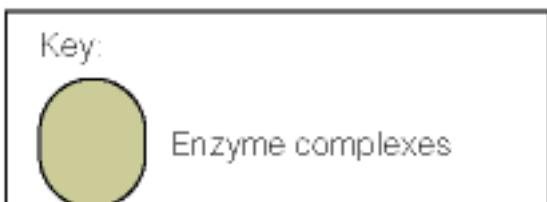
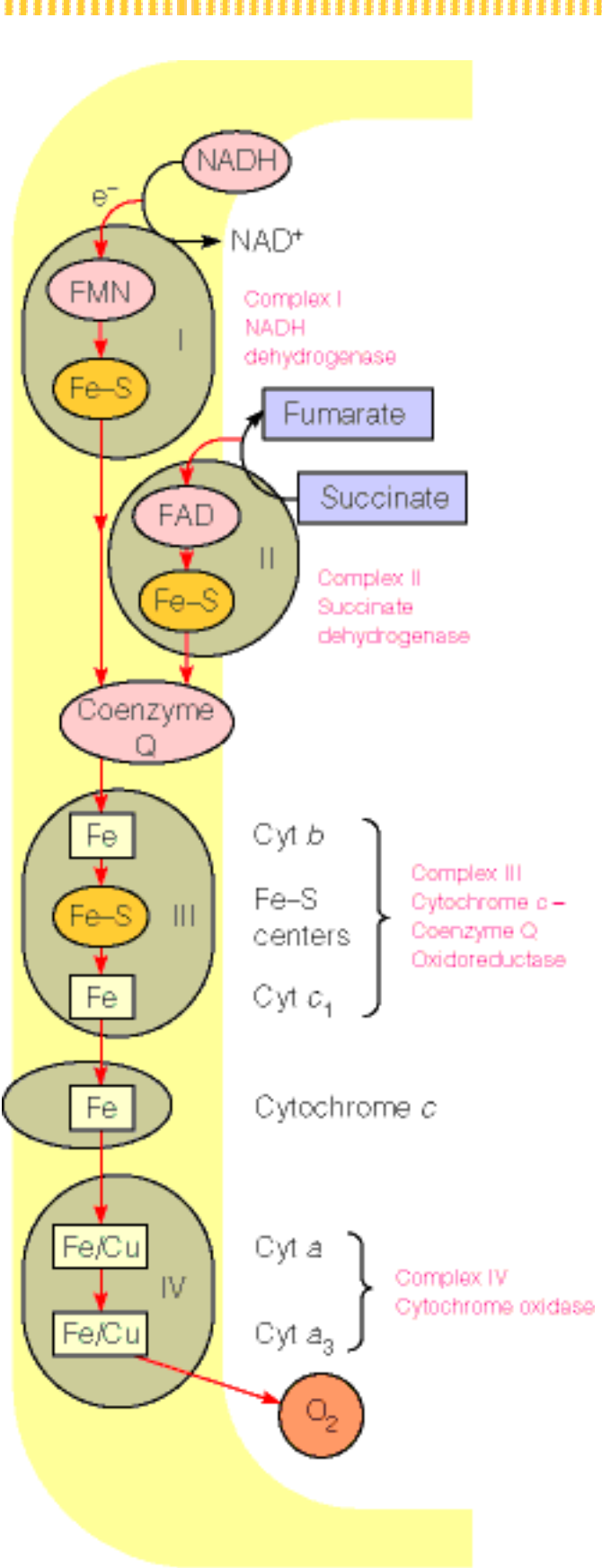

Key:



Enzyme complexes



Organic coenzymes and prosthetic groups



Iron-sulfur centers

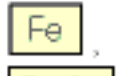

Cytochromes

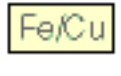

(heme iron)

Cytochromes

Cytochromes are a group of red or brown **heme**-containing proteins ([Figure 15.6](#)) having distinctive visible-light spectra ([Figure 15.5](#)). The major respiratory **cytochromes** are classified as b, c, or a, depending on the wavelengths of the spectral absorption peaks. Within each class (b, c, or a), the **cytochromes** are distinguished by smaller spectral differences. For example, **cytochrome c1** has a spectrum similar to that of **cytochrome c**, but the α and γ absorption peaks are shifted slightly toward the red.

Among the respiratory electron carriers are three b-type cytochromes, **cytochromes c** and **c1**, and **cytochromes a** and **a3**. **Cytochromes b, c, and c1** all contain the same heme found in hemoglobin and myoglobin - iron complexed with protoporphyrin IX ([Figure 7.4](#)). In **cytochromes c** and **c1**, but not **b**, this heme is linked covalently to the protein component via thioether bonds formed between two of the vinyl side chains and two cysteine residues ([Figure 15.6a](#)).

Cytochromes a and **a3** contain heme A, in which two of the side chains are modified ([Figure 15.6b](#)). **Cytochromes a** and **a3** evidently represent two identical heme A moieties, attached to the same polypeptide chain. They are within different environments in the inner membrane, however, so they have different reduction potentials. Each of the hemes in **cytochromes a** and **a3** is associated with a copper ion, located close to the heme iron. **Cytochromes** undergo oxidoreduction through the complexed metal, which cycles between +2 and +3 states for the heme iron and +1 and +2 states for the copper in **cytochromes a** and **a3**. Thus, the **cytochromes** are one-electron carriers. **Cytochromes a** and **a3** form part of mitochondrial complex IV ([Figures 15.2](#) and [15.3](#)).

Cytochrome c is a small protein ($M_r = 13,000$). It is associated with the inner membrane of the mitochondria, but is readily extracted in soluble form. Because it is small and relatively abundant, detailed structural studies have been carried out with this protein. The amino acid sequence of the protein has been highly conserved in evolution, with nearly 50% identity between residues at corresponding positions of **cytochromes c** in organisms as diverse as yeast and human. The other **cytochromes** are integral membrane proteins and are exceedingly difficult to dissociate from the membrane. As a result, less is known about their structure.

See also: [Electron Transport](#), [Heme A](#), [Protoporphyrin IX](#)

Figure 15.6: The hemes found in cytochromes.

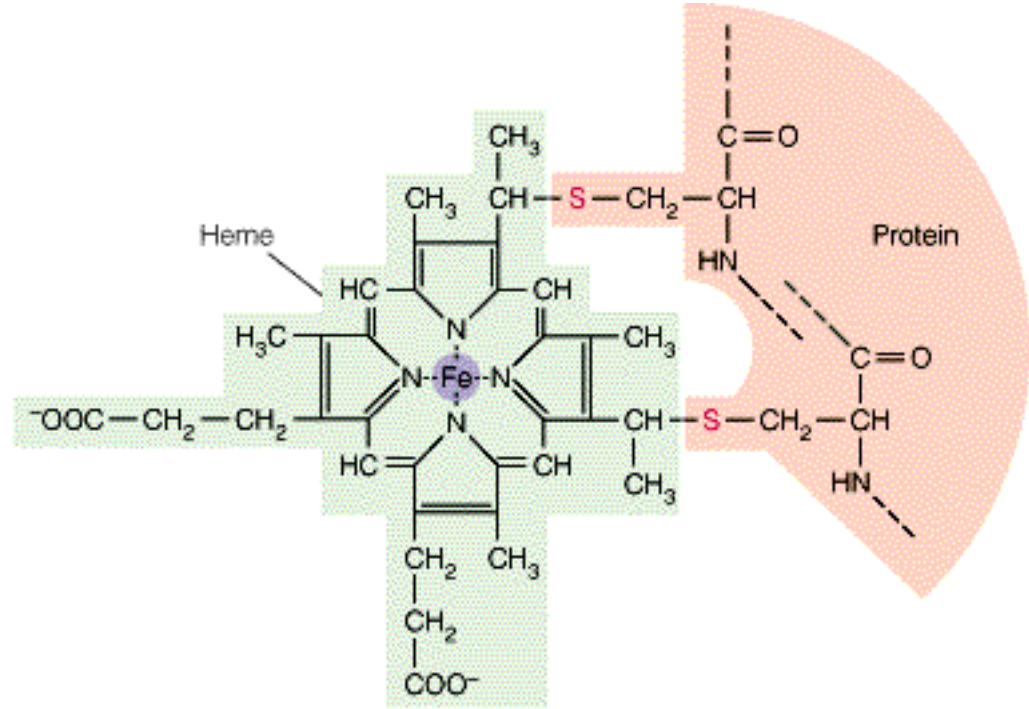

(a) General structure of cytochromes *c* and *c₁*

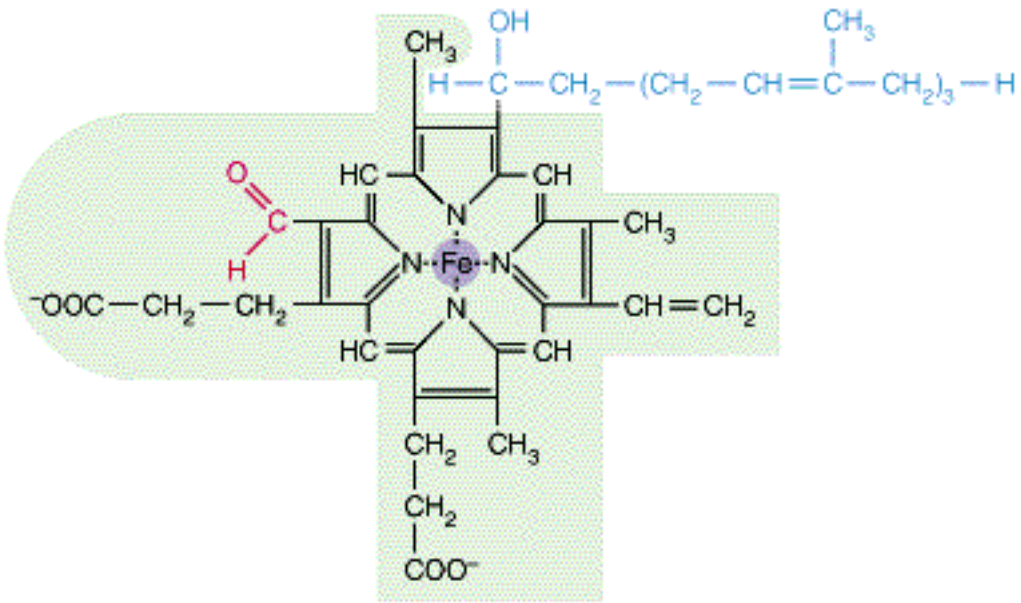

(b) Heme A in cytochromes *a* and *a₃*

Figure 15.5: Absorption spectra of cytochromes.

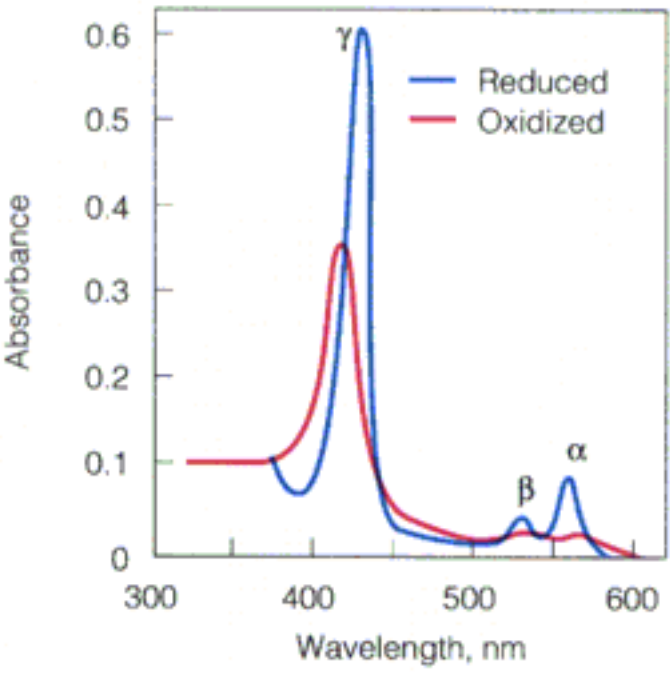

(a) Cytochrome *b*

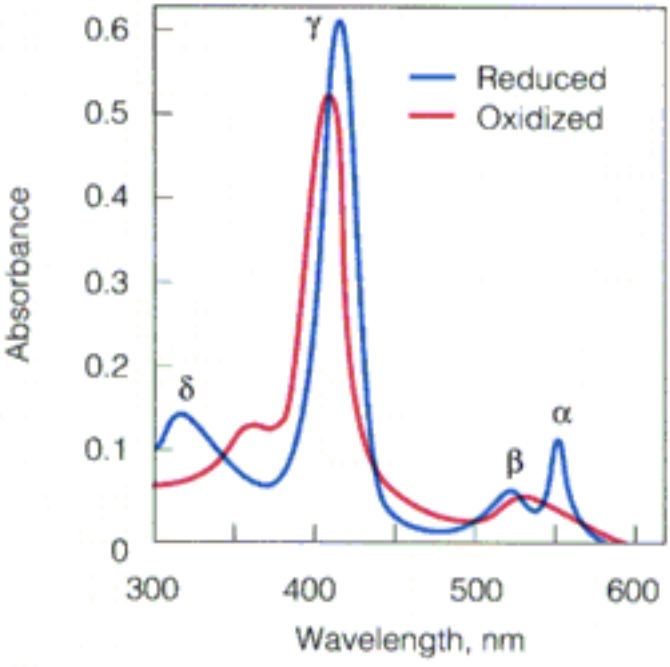

(b) Cytochrome *c*

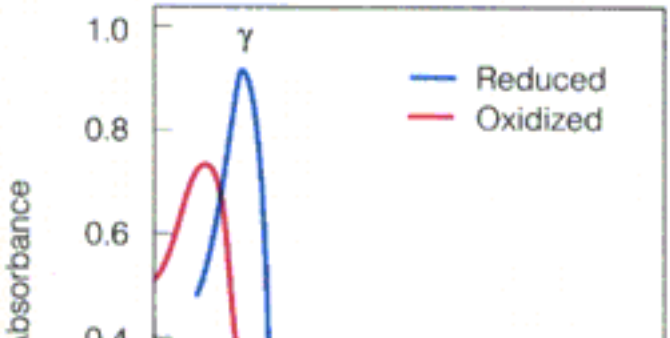

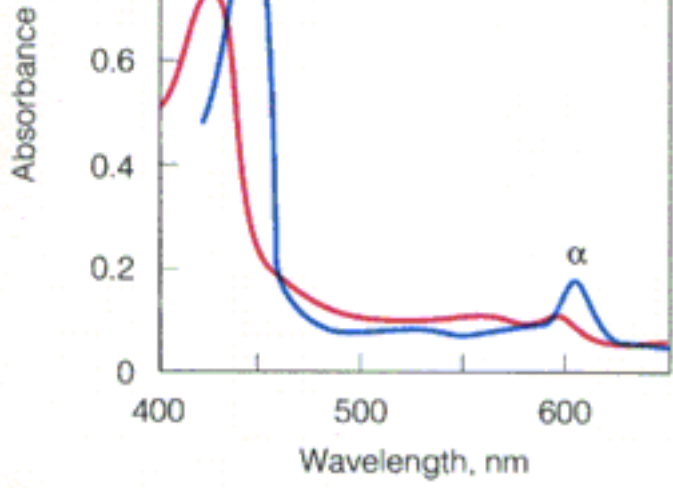

(c) Cytochromes *a* and *a*₃

Adapted from A. Tzagoloff, *Mitochondria* (New York: Plenum, 1982). Reprinted by permission.

Heme A

Heme A is a form of **heme** found in cytochromes a and a₃. In this form of **heme**, two of the sides chains have been modified ([Figure 15.6b](#))

See also: [Heme](#), [Cytochromes](#)

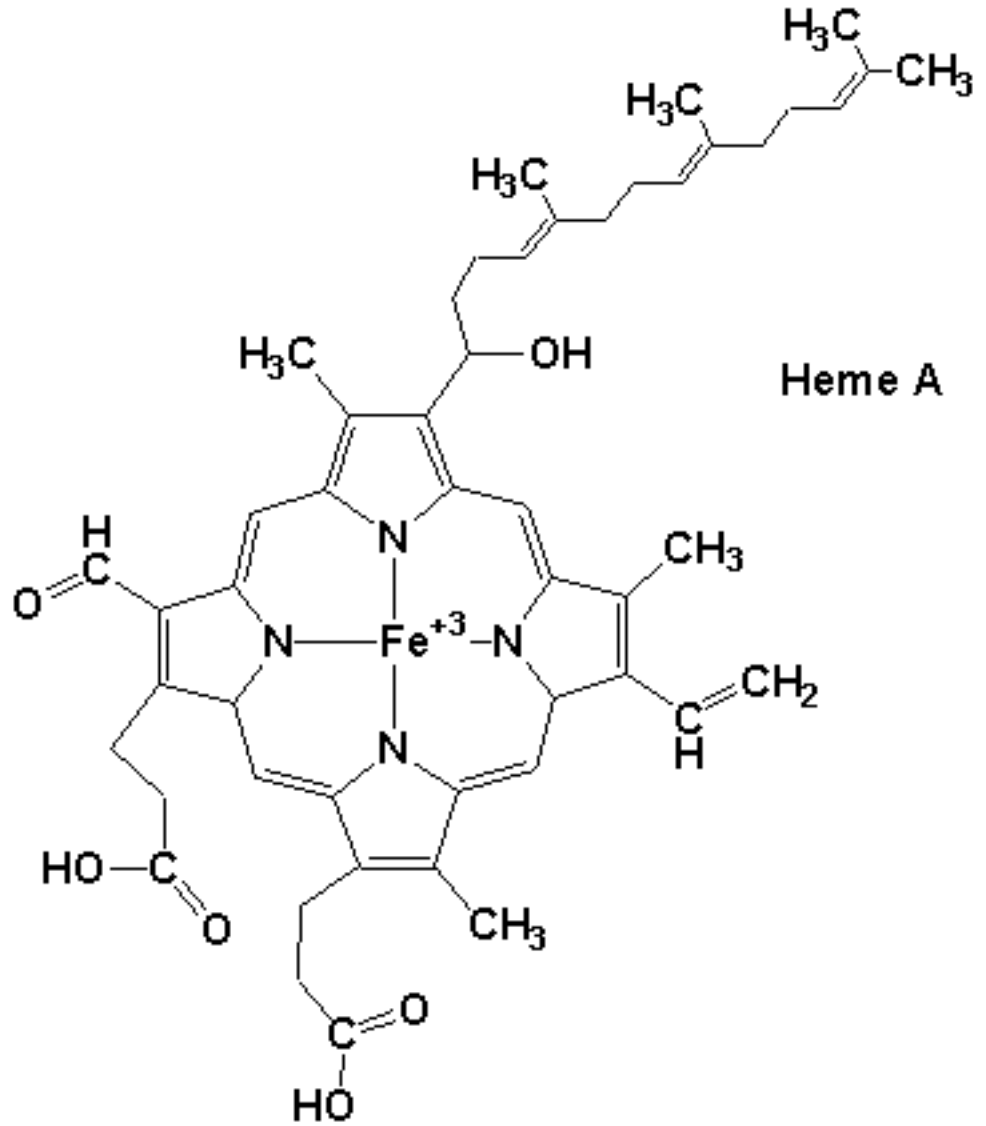

Chorismic Acid (Chorismate)

Chorismic acid is a metabolic intermediate that is the branch point in the synthesis of **coenzyme Q** and the aromatic amino acids, **phenylalanine**, **tyrosine**, and **tryptophan** (**Figure 21.12**).

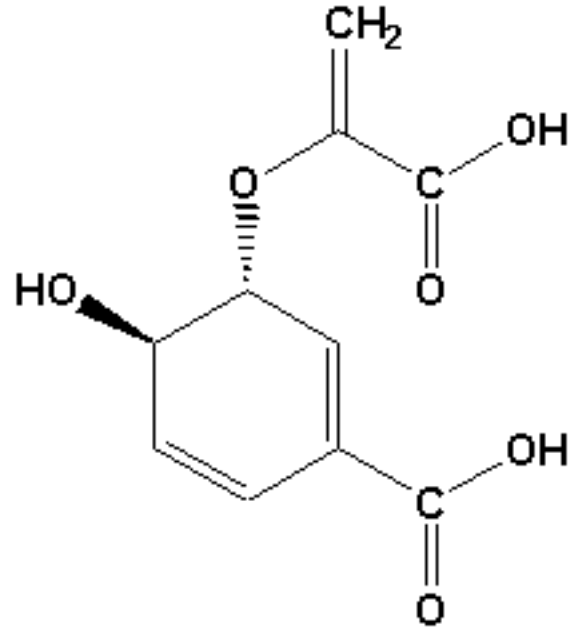

Chorismic Acid (Chorismate)

Chorismate is formed from **5-enoylpyruvylshikimic acid 3-phosphate** (**Figure 21.13**). Conversion of **chorismate** to **p-hydroxybenzoic acid** leads to synthesis of coenzyme Q. Conversion of **chorismate** to **anthranilate** leads to biosynthesis of tryptophan (**Figure 21.14**).

See also: **Metabolism of Aromatic Amino Acids and Histidine**, **Coenzyme Q**, **p-Hydroxybenzoic Acid**, **p-Aminobenzoic Acid**

5-Enoylpyruvylshikimic Acid-3-Phosphate

5-Enoylpyruvylshikimic acid-3-phosphate ([Figure 21.13](#)) is the immediate metabolic precursor of **chorismate**. Chorismate is a metabolic branch point for synthesis of tryptophan and phenylalanine/tyrosine. Yet another branch from chorismate leads to **coenzyme Q** ([Figure 21.14](#)).

See also: [Metabolism of Aromatic Amino Acids and Histidine, Figure 21.12](#)

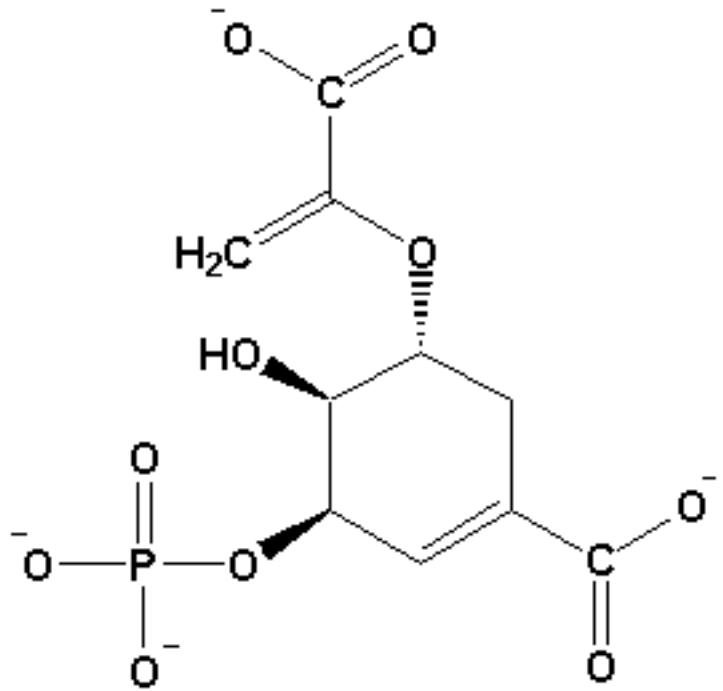

INTERNET LINK: [Phenylalanine, Tyrosine, and Tryptophan Biosynthesis](#) **5-enoylpyruvylshikimic acid 3-phosphate**

Figure 21.13: Details of the shikimic acid pathway, I.

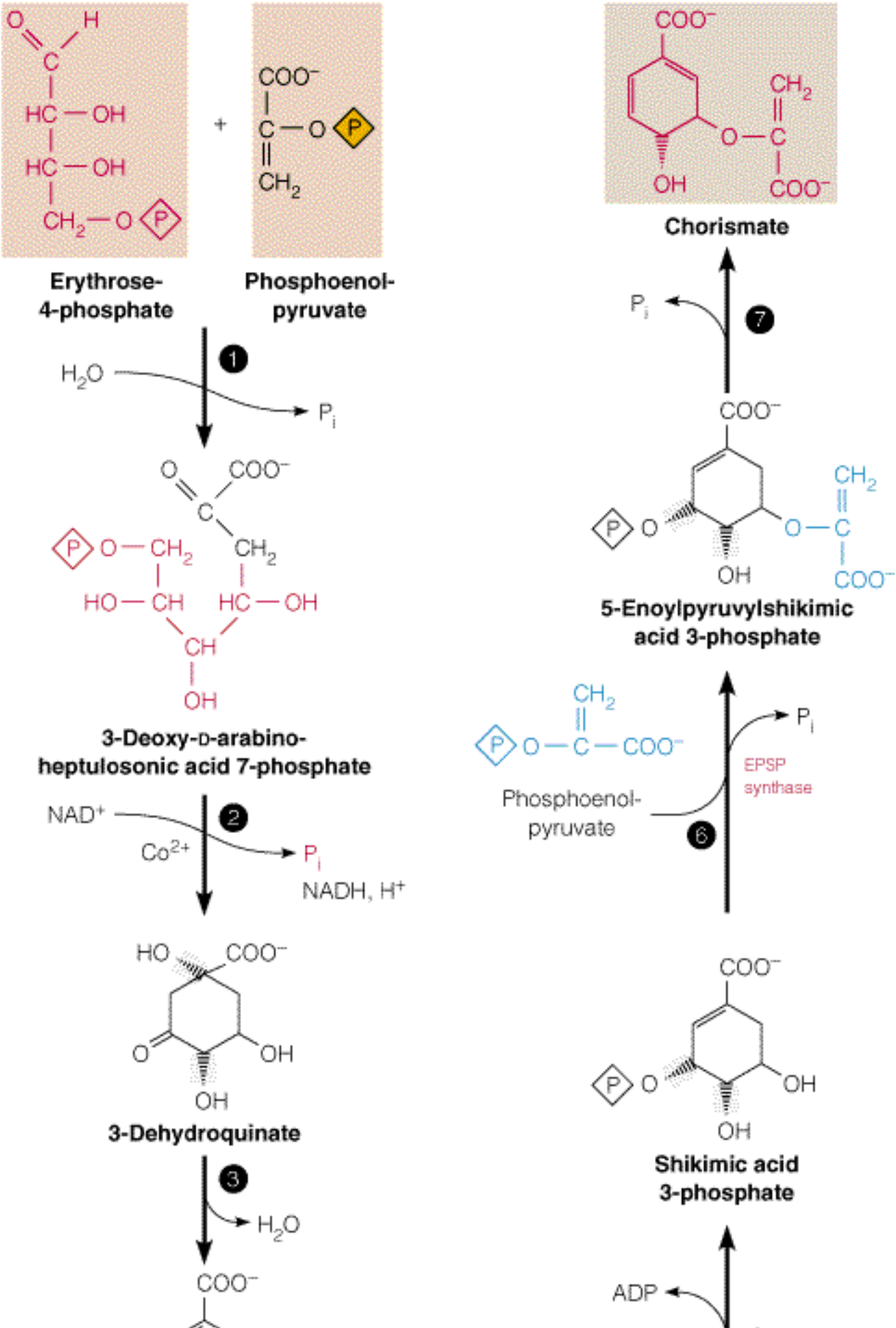

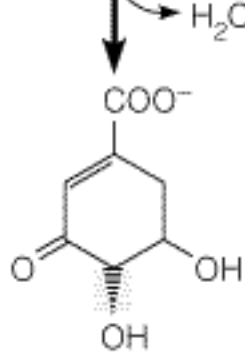

3-Dehydroshikimate

NADPH + H⁺

4

Shikimate
dehydrogenase
NADP⁺

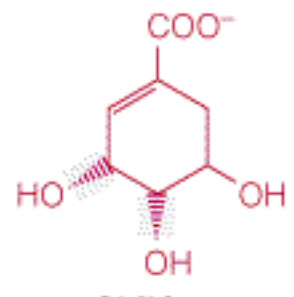

D-Shikimate

ADP

ATP

5



Figure 21.14: Details of the shikimic acid pathway, II.

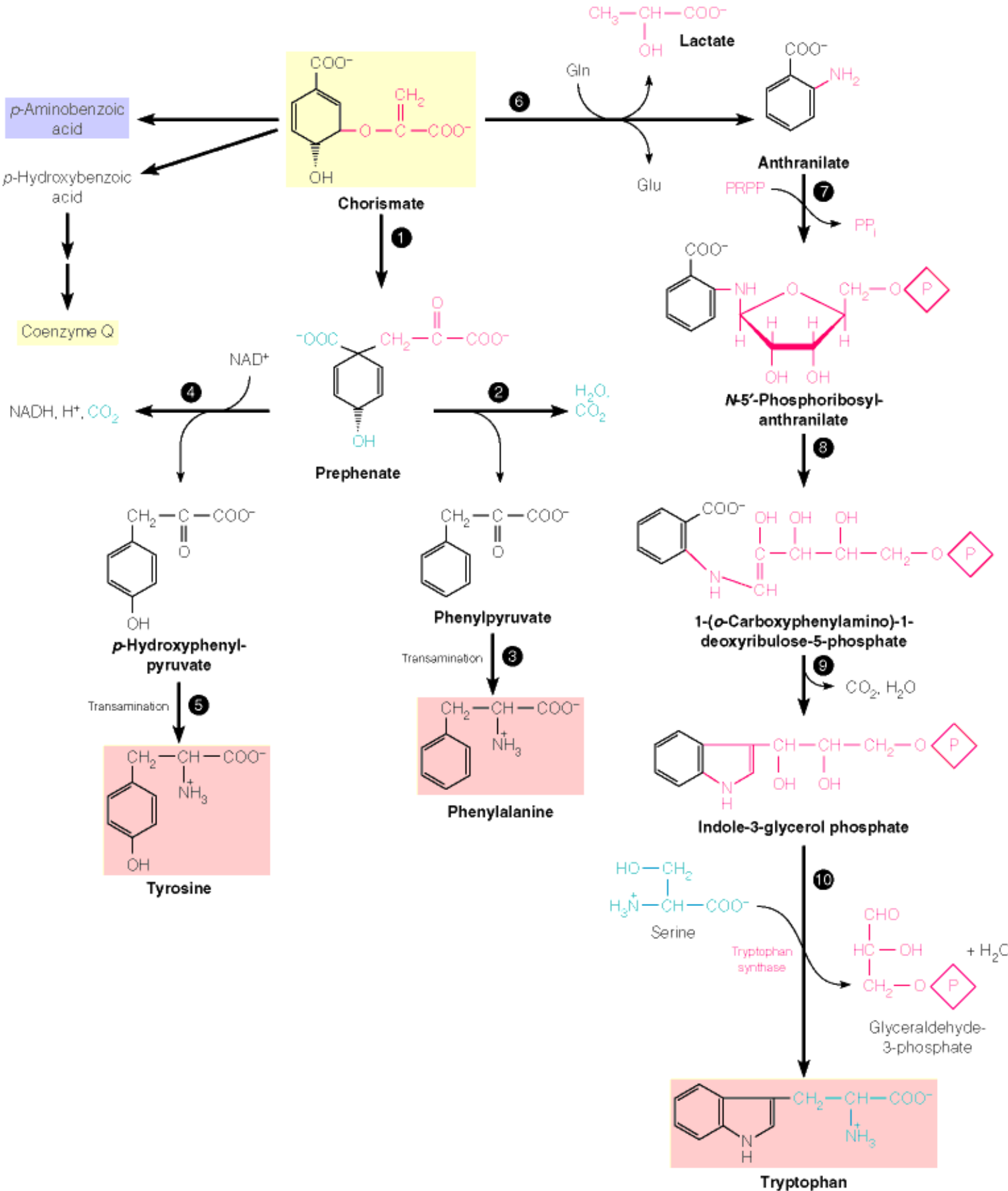

N

H

S

Tryptophan

p-Hydroxybenzoic Acid

Figure 21.12 provides an overview of the biosynthesis of aromatic amino acids and histidine. All of the carbons in phenylalanine and tyrosine are derived from erythrose-4-phosphate and phosphoenolpyruvate. A key intermediate in synthesis of virtually all aromatic compounds (including **p-aminobenzoic acid**) in plant and bacterial cells is shikimic acid. Shikimic acid gives rise to chorismate (**Figure 21.13**), which is a precursor of **p-hydroxybenzoic acid** (**Figure 21.14**). **p-Hydroxybenzoic acid**, in turn, can be converted to coenzyme Q.

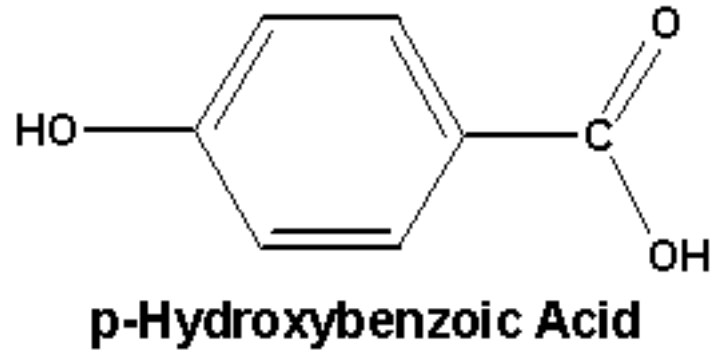

See also: [Metabolism of Aromatic Amino Acids and Histidine](#), [Shikimic Acid](#), [Erythrose-4-Phosphate](#), [Phenylalanine](#), [Folate](#), [Chorismate](#), [Coenzyme Q](#)

6-Phosphogluconate Dehydrogenase

6-Phosphogluconate dehydrogenase is an enzyme of the [pentose phosphate pathway](#) that catalyzes the reaction below:



Note that this reaction is an oxidation/reduction reaction and that NADPH is produced as the reaction proceeds to the right.

See also: [PPP Enzymes](#), [Oxidation](#), [PPP Intermediates](#)

INTERNET LINK: [Pentose Phosphate Pathway](#)

Oxidation/Reduction

Oxidation/reduction reactions involve the transfer of electrons from a molecule being oxidized (the electron donor) to a molecule being reduced (the electron acceptor). Because one or more electrons are transferred, neither oxidation nor reduction can occur without the other occurring simultaneously. An example of an oxidation/reduction reaction is the following reaction, catalyzed by succinate dehydrogenase, from the citric acid cycle:

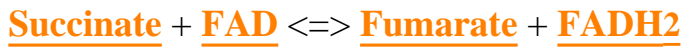

Succinate is the electron donor (so it is oxidized) and FAD is the electron acceptor (so it is reduced). The products of the reaction are fumarate (oxidized) and FADH₂ (reduced). Cells typically use a common set of electron acceptors, such as FAD, NAD⁺ and NADP⁺. Many of these molecules deposit their electrons into the electron transport system.

See also: Electron Transport (from Chapter 15), NADP⁺, NAD⁺, FAD

Phosphopentose Isomerase

Phosphopentose isomerase is an enzyme of the pentose phosphate pathway that catalyzes the reaction below:

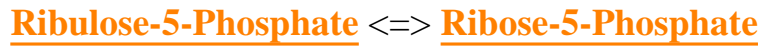

See also: [Pentose Phosphate Pathway](#), [Pentose Phosphate Pathway Enzymes](#)

INTERNET LINK: [Pentose Phosphate Pathway](#)

Arabinose Operon

The **arabinose operon** features a single protein which acts as both a positive and a negative transcriptional regulator, depending upon the binding of particular ligands ([Figure 26.39](#)).

Three structural genes are located in the **arabinose operon**--*araB*, *araA*, and *araD*. They encode enzymes that convert arabinose to [xylulose-5-phosphate](#).

Regulation - The *araC* gene encodes a regulatory protein that binds to arabinose, the inducer of the operon. Binding of the AraC - arabinose complex at a site called *araI* activates transcription of the arabinose operon, but only when the cAMP - CRP complex (see [here](#)) is bound at an adjacent site. Thus, whereas the *lac* operon requires one protein to be bound and one to be dissociated for maximal transcription, the **arabinose operon** requires two proteins to be bound at adjacent sites.

When arabinose levels are low, the AraC protein acts as a repressor and binds to two operator sites, *araO1* and *araO2*, as well as to *araI*. Binding to *araO1* inhibits transcription of the *araC* gene itself. Thus, *araC* is autoregulated at the level of its own transcription. AraC molecules bound to *araO2* and *araI* interact with each other to form a DNA loop. This structure causes repression of transcription of the *araBAD* genes.

See also: [Lactose Operon Regulation](#), [Transcription Regulation in Phage \$\lambda\$](#) , [Galactose Operon](#), [trp Operon Regulation](#)

Arabinose

D-Arabinose is a five carbon sugar contained in some plant cell walls (as glycosides) and in *tuberculosis bacilli*.

L-Arabinose is a five carbon sugar widely distributed in plants and bacterial cell walls. It forms a part of plant glycoproteins.

See also: [cAMP Receptor Protein](#), [Arabinose Operon](#)

INTERNET LINKS:

1. [Pentose Metabolism](#)
 2. [3D Structure](#)
-

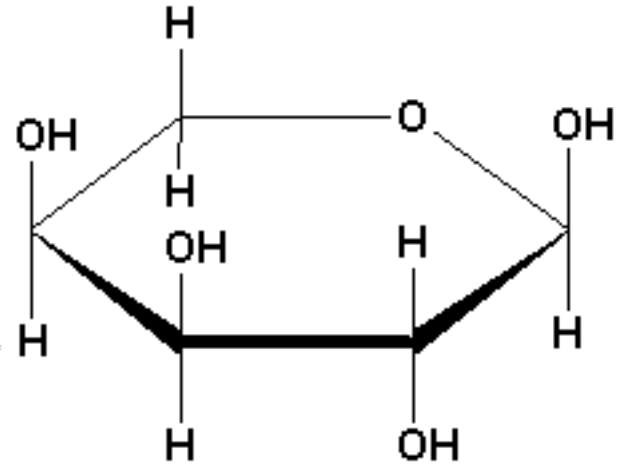

Arabinose

Figure 26.19: The 122-base lac regulatory region.

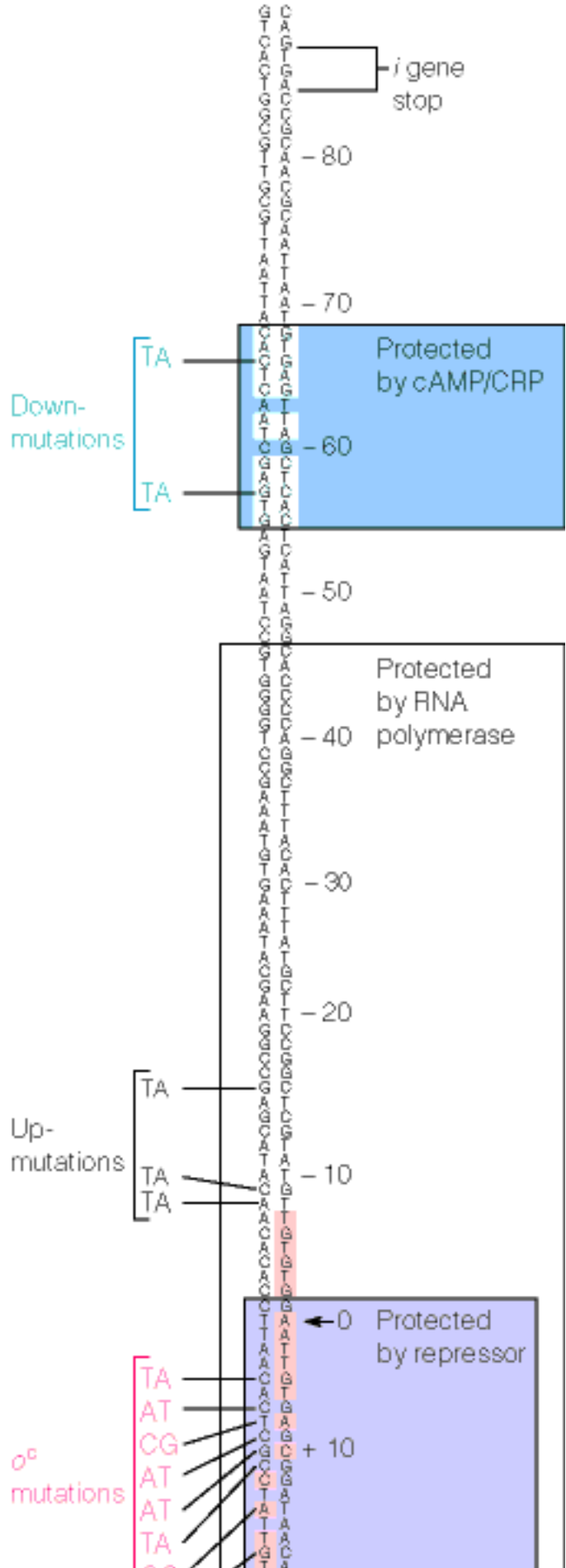

σ^s mutations

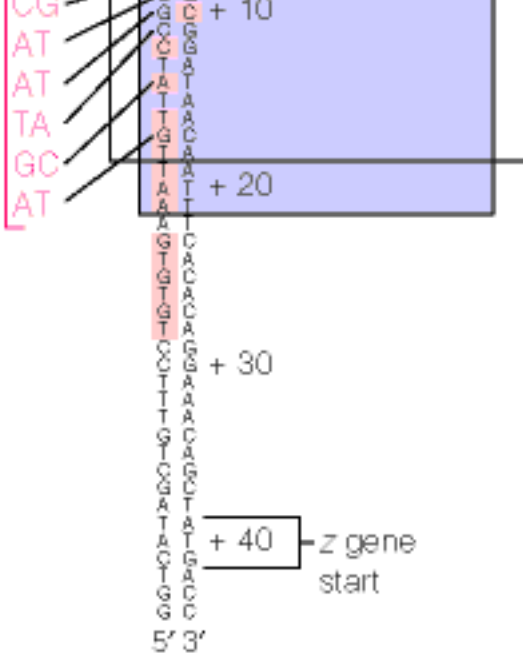
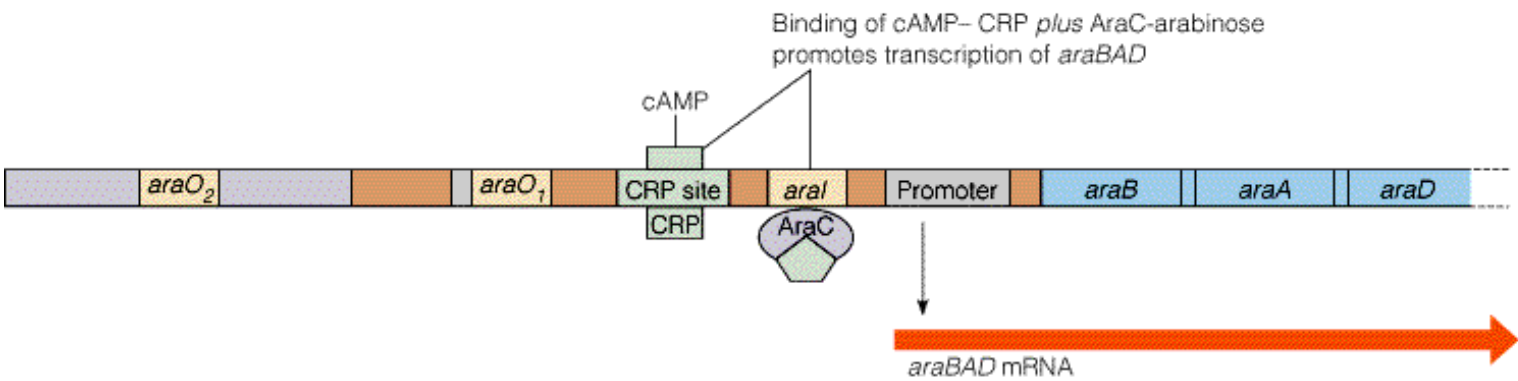
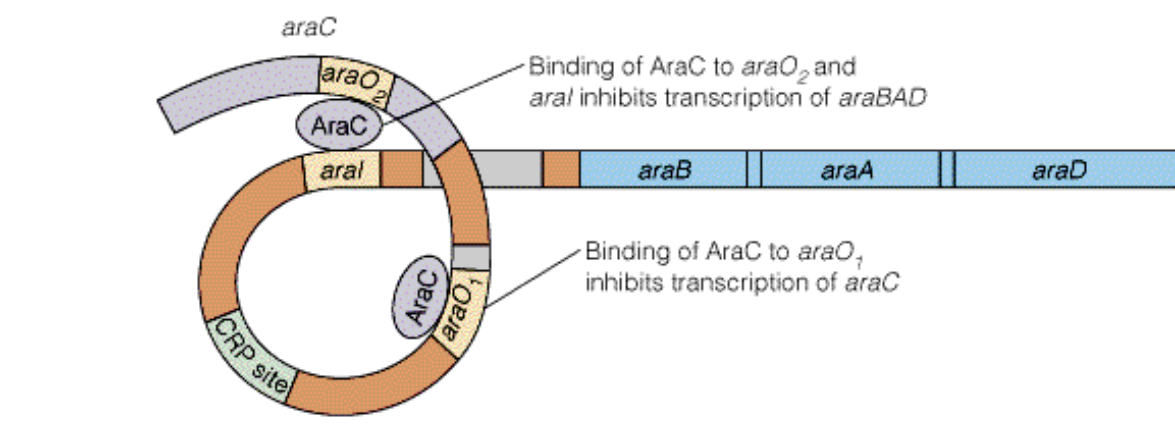
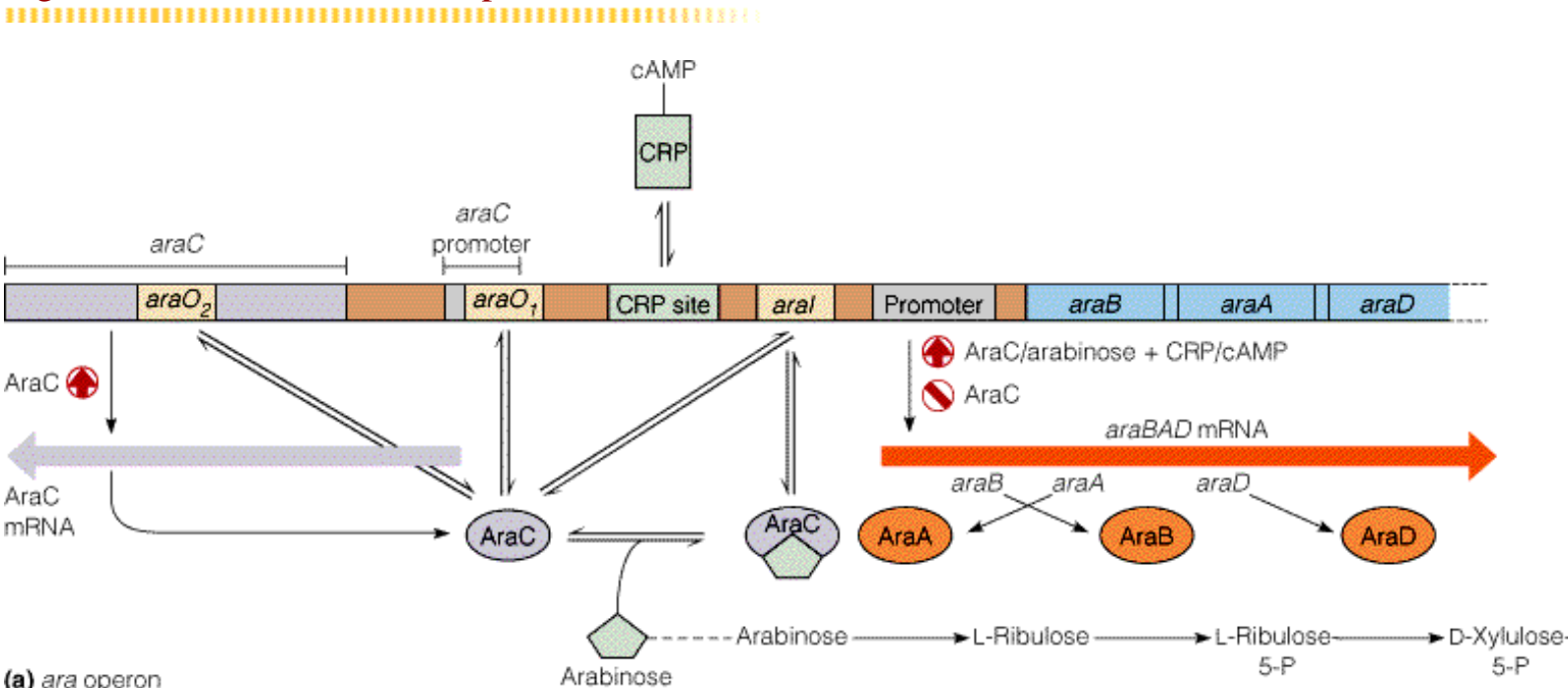

Figure 26.39: The *E. coli* *ara* operon.



(c) Positive regulation at high arabinose levels

Transcription Regulation in λ Phage

Repressors/Operators - Critical events in λ **transcriptional regulation** involve two different repressor proteins, called **cI** and **Cro**, each of which binds at two different operators. Each operator contains three repressor binding sites. The repressors bind to each of the six operator sites with varying affinities, leading to varying occupancy of each binding site by each repressor under varying physiological conditions. The cI repressor also serves, under certain conditions, as a transcriptional activator, promoting the expression of some genes while repressing that of others. Cro acts both as a repressor and as an antirepressor, because it antagonizes the action of cI in a very specific way (**Figure 26.27**). Transcription from the two promoter-operator sites takes place in opposite directions along the genome (**Figure 26.23**).

The λ cI Repressor and its Operators - The cI repressor is a dimeric protein, with a subunit Mr of 27,000. It binds through its N-terminal sequences to operator sites with a K_a of about 3×10^{13} M (**Figure 26.24**). Two operators, on either side of the cI gene, control divergent transcriptional events from a central regulatory region-leftward (OL) and rightward (OR). Each operator contains three separate repressor-binding sites, each about 17 base pairs long. The three repressor-binding sites are homologous, but not completely so (**Figure 26.26**), and they are separated by spacer regions of three to seven base pairs. A fully virulent mutant (one which does not establish a lysogenic state) has at least two mutations-one in OL and one in OR.

λ Operator features - The λ operators have the following interesting features:

1. Operators and promoters are interspersed, so the regulatory regions are more properly called OLPL and ORPR;
2. ORPR controls transcription from two distinct promoters-one rightward (PR) and one leftward (PRM) (**Figure 26.26**);
3. Transcription from OLPL and ORPR is controlled by two different repressors-cI and Cro;
4. Under certain conditions the cI repressor is a transcriptional activator, not an inhibitor; and
5. cI transcription is initiated from different promoters under different physiological conditions.

All of these complexities are related to the need for orderly and efficient phage gene control under quite different physiological conditions.

Interactions Between the Two λ Repressors - The decision between lytic and lysogenic infection is made at ORPR. It involves interactions of cI and Cro. Of the three repressor-binding sites in ORPR, cI binds most tightly to site OR1, less tightly to OR2, and still less tightly to OR3. cI binding is cooperative, so that when one repressor dimer is bound at OR1, affinity for a second molecule is increased at OR2. Cro protein binds considerably less tightly to any of the sites than does cI and in the reverse order. That is, site OR3 is favored, followed by approximately equal binding at OR2 and OR1. Binding of Cro is noncooperative.

Lysogeny establishment - As lysogeny is being established ([Figure 26.27b](#)), when lytic and lysogenic genes are competing to determine the fate of the viral genome, there is a need for larger amounts of cI repressor than can be transcribed from PRM (the 'M' stands for "maintenance," because this is the promoter from which cI is transcribed during maintenance of lysogeny). At this time a cI promoter, called PRE (the 'E' stands for "establishment"), is activated. In this activation the cII protein binds specifically at the -35 region of PRE and stimulates RNA polymerase binding at that site. This transcriptional event yields a longer cI messenger RNA that is more efficiently translated than the message synthesized from PRM. The result is sufficient cI repressor to bind all three sites in OR and, hence, to block both transcriptional initiation events. Because of the cooperative binding of cI to its operators, both sites OR1 and OR2 are usually occupied in the lysogenic state ([Figure 26.27a](#)), even though the intracellular concentration of cI is quite low (about 200 molecules per cell, or 10^{-7} M). Binding of cI in this manner inhibits the transcription of Cro from its own promoter and activates the leftward transcription of itself from the promoter PRM. The -10 and -35 regions for the PRM promoter lie within the operators.

Lytic infection - In prophage induction, lysogeny is broken, leading to a lytic infection ([Figure 26.27c](#)). First, cI repressor is inactivated, and the OR sites become unoccupied. This permits transcription of *cro* from PR, and the Cro protein blocks further transcription of *cI* from PRM. At the same time, leftward transcription from PL generates the N protein, blocking transcriptional termination at the sites indicated in [Figure 26.27](#) as tR1 and tL. Thus, the two early transcripts for Cro and N are extended to activate new genes. Leftward transcription generates Int and Xis proteins, necessary for prophage excision. Rightward transcription generates O and P, both of which are necessary for DNA replication.

Subsequent regulatory events, including the action of the gene *Q* protein, activate transcription of late-acting genes, which encode structural proteins of the virus. At this time it is desirable to suppress early gene transcription, so that the late proteins can be made at maximal rates. This involves further action of the Cro protein, which by this time has accumulated to the point that it can bind to both OR1 and OL1, blocking transcription from PR and PL, respectively ([Figure 26.27d](#)). In infection by a virulent mutant ([Figure 26.27e](#)), *cI* transcription from PRM is blocked, and this leads to activation of *cro* transcription from PR.

See also: λ [Phage Biology](#), [Structure of Cro and cI Repressors](#), [Lactose Operon Regulation](#)

INTERNET LINKS:

1. [Bacteriophage \$\lambda\$](#)
 2. [Cro Repressor Image](#)
-

cI Repressor

The **cI repressor** is a dimeric protein from bacteriophage λ , with a subunit M_r of 27,000. **cI repressor** binds through its N-terminal sequences to operator sites with a K_a of about $3 \times 10^{13} \text{ M}$ ([Figure 26.24](#)). Two operators, on either side of the **cI** gene, control divergent transcriptional events from a central regulatory region-leftward (OL) and rightward (OR). Each operator contains three separate repressor-binding sites, each about 17 base pairs long. The three repressor-binding sites are homologous, but not completely so ([Figure 26.26](#)), and they are separated by spacer regions of three to seven base pairs. A fully virulent mutant (one which does not establish a lysogenic state) has at least two mutations-one in OL and one in OR.

See also: [Transcriptional Regulation in Phage \$\lambda\$](#) , [Cro Repressor](#)

Figure 26.24: Structure and DNA binding of λ cI repressor.

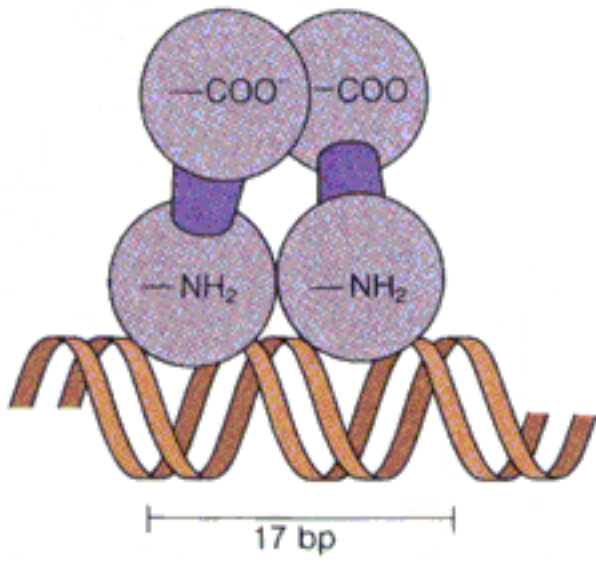

From M. Ptashne, *A Genetic Switch: Gene Control and Phage λ* (Cambridge, Mass.: Cell Press & BSI, 1986).

Figure 26.26: The ORPR region.

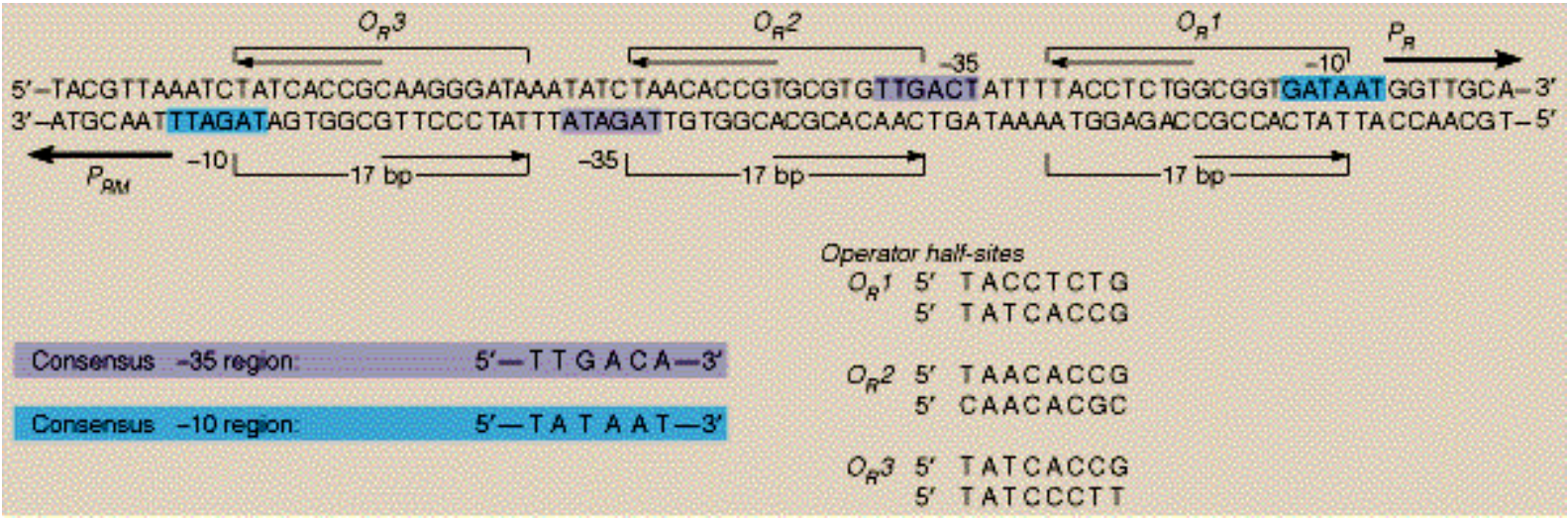

Cro Repressor

Cro repressor is a protein in bacteriophage λ that is a homodimer of 66-residue subunits folded into three α -helical regions and three β strands ([Figure 26.28](#)). Two of the helices, numbered 2 and 3 in the figure, are separated by a short β turn, forming a helix - turn - helix motif (see [here](#)).

Cro binds to the operators OR3, OR2, and OR1 in λ with decreasing affinities. **Cro** acts both as a repressor and as an antirepressor, because it antagonizes the action of [cI repressor](#) in a very specific way ([Figure 26.27](#)). Transcription from the two promoter-operator sites takes place in opposite directions along the genome ([Figure 26.23](#)). Binding of cI to OR1 and OR2 inhibits the transcription of **Cro** from its own promoter and activates the leftward transcription of cI from the promoter PRM (the M stands for "maintenance," because this is the promoter from which cI is transcribed during maintenance of lysogeny). Thus, when cI binds OR1 and OR2, the lysogenic state is favored.

The lysogenic state is broken as follows:

First, cI repressor is inactivated, and the OR sites become unoccupied. This permits transcription of *cro* from PR, and the **Cro** protein blocks further transcription of *cI* from PRM. At the same time, leftward transcription from PL generates the N protein, blocking transcriptional termination at the sites indicated in [Figure 26.27](#) as tR1 and tL. Thus, the two early transcripts for **Cro** and N are extended to activate new genes. Leftward transcription generates Int and Xis proteins, necessary for prophage excision. Rightward transcription generates O and P, necessary for DNA replication. Subsequent events lead to transcription of late genes and completion of the phage life cycle.

See also: [Transcriptional Regulation in Phage \$\lambda\$](#) , [Structure of Cro and cI Repressors](#)

Figure 26.28: Structure of the Cro dimer-operator complex.

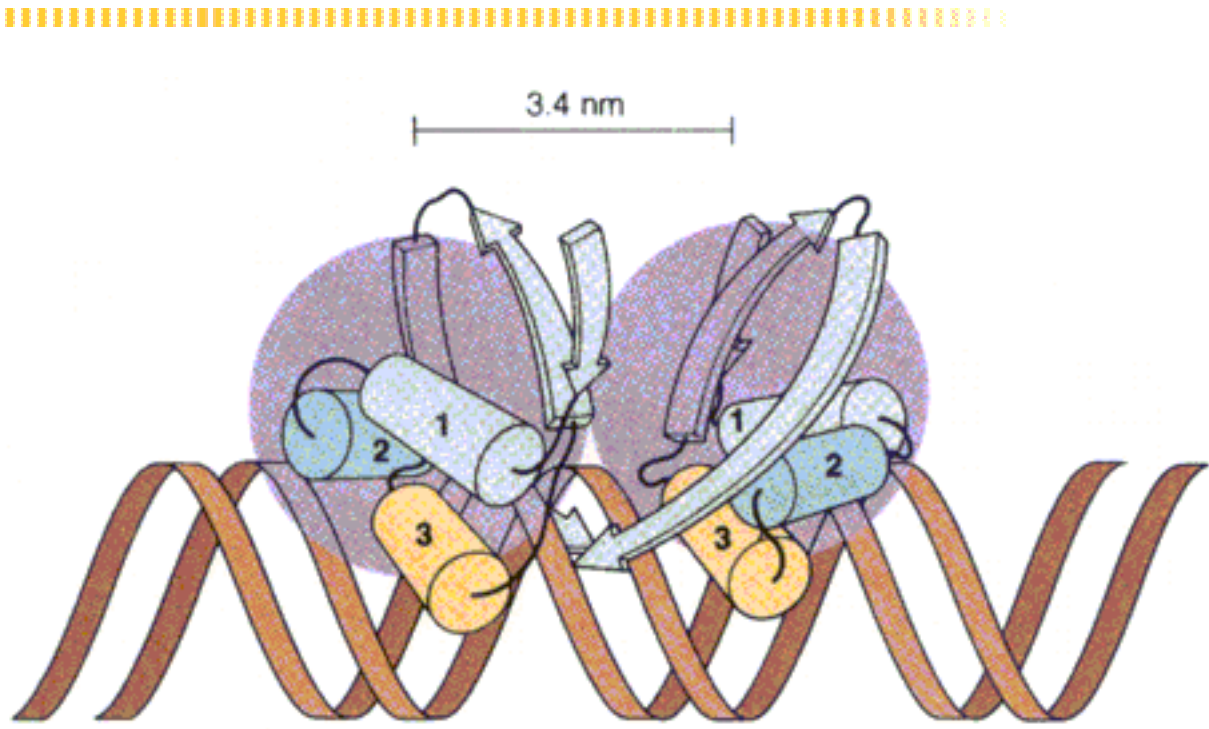

Figure 26.27: cI-Cro interactions in the ORPRPRM region.

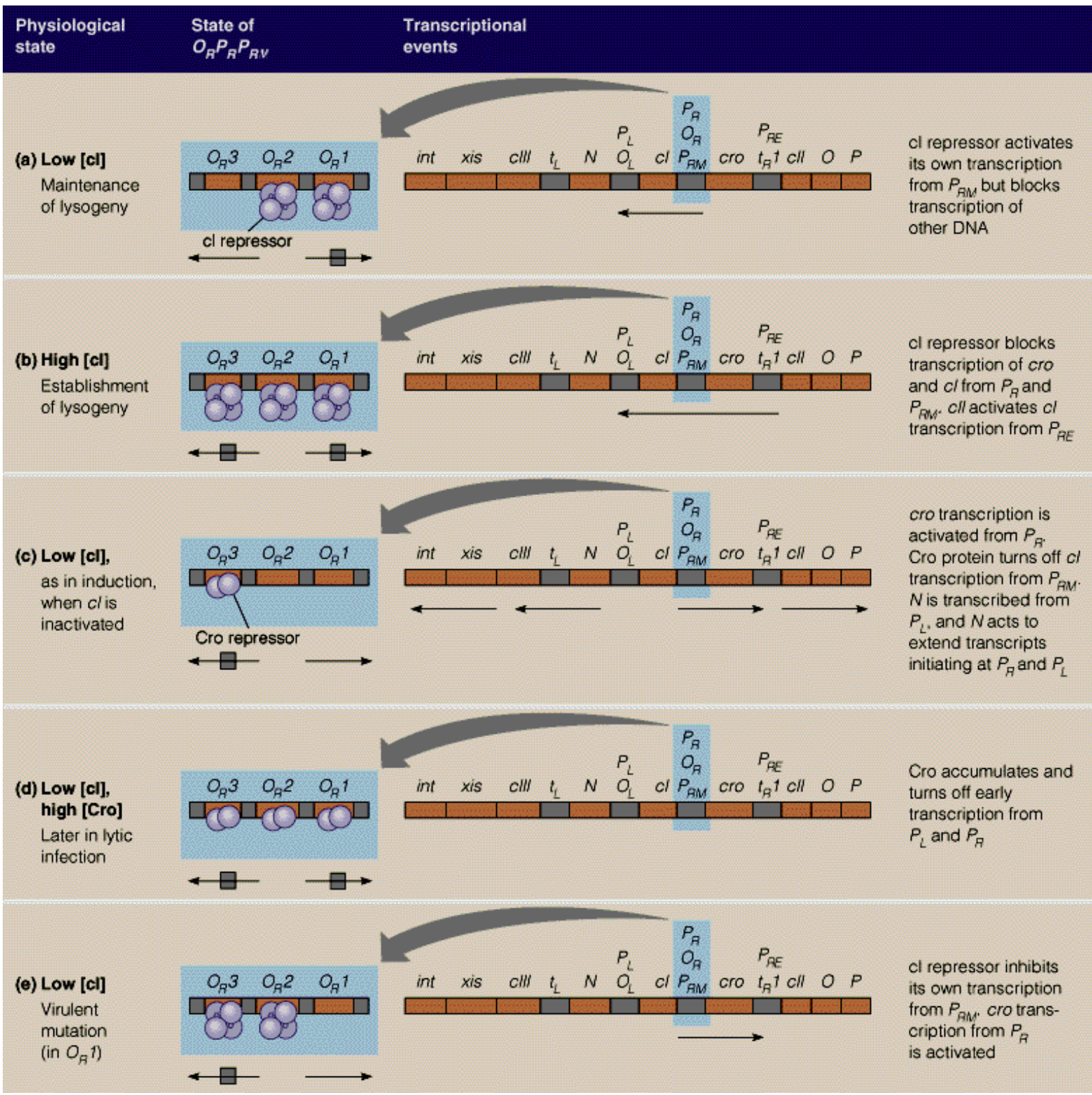
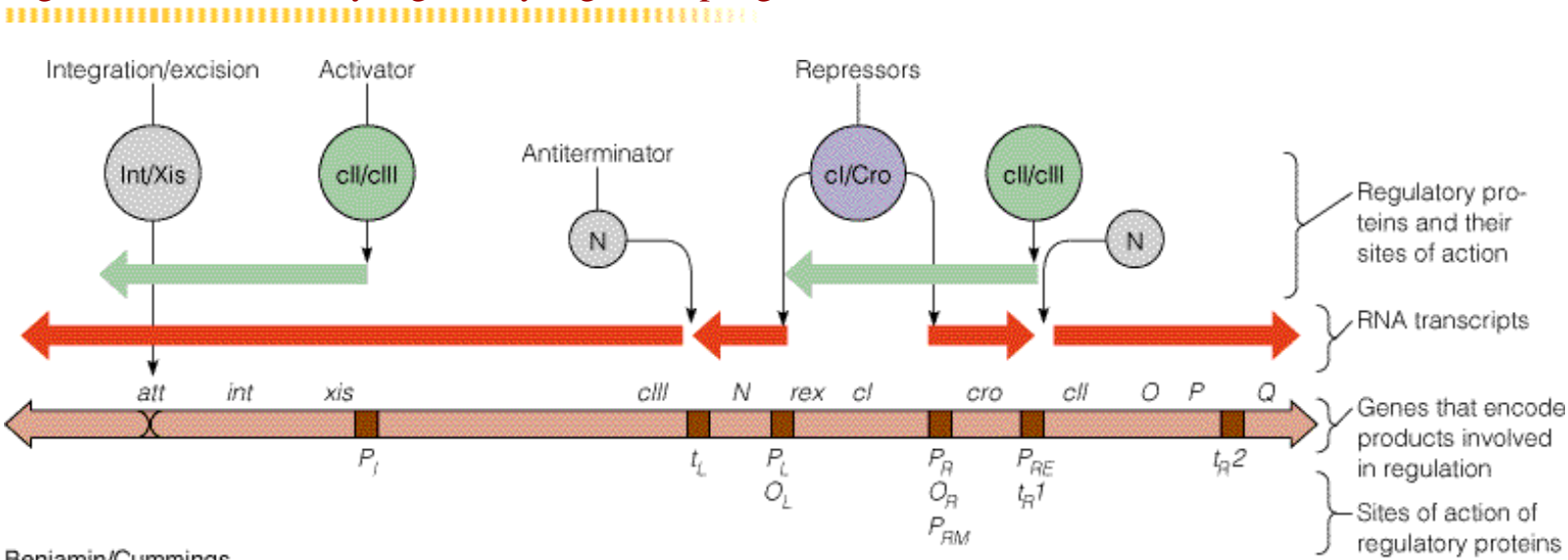

Figure 26.23: The early regulatory region of phage λ .



Raniamin/Cummins

Structure of Cro and cI Repressors

Cro Structure - **Cro** is a homodimer of 66-residue subunits folded into three α -helical regions and three β strands (**Figure 26.28**). Two of the helices, numbered 2 and 3 in the figure, are separated by a short β turn, forming a helix-turn-helix motif (see [here](#) and [here](#)). In the **Cro** dimer the two number 3 helices are 3.4 nm apart, the length of one turn of the DNA double helix. This distance is consistent with the two subunits binding on the same side of the DNA helix, in adjacent major groove sites, with the number 3 helices lying lengthwise in the grooves.

The amino acid sequence within and between helices 2 and 3 show remarkable homology with corresponding sequences in a large family of sequence-specific DNA-binding proteins but not with DNA-binding proteins that showed no sequence preference. The helix-turn-helix motif is a commonly evolved structural element in transcriptional regulatory proteins, at least in prokaryotes. A different motif, the zinc finger, is present in a large number of eukaryotic DNA-binding proteins (and a few known prokaryotic proteins). Other structural patterns of DNA-binding proteins, including the helix-loop-helix and the leucine zipper, have been described. These motifs are discussed [here](#).

cI Structure - The λ **cI repressor** also has a helix-turn-helix motif. The relevant three-dimensional similarities for **Cro**, cAMP receptor protein (CRP, see [here](#)), and **cI** repressor are shown in **Figure 26.29**. **cI** repressor contains an additional binding determinant—a pair of "arms," or short polypeptide segments that extend from helix 1. They can be seen in **Figure 26.1**, extending around the helix and establishing contacts on the other side of the DNA duplex. These arms probably explain why **cI** binds more tightly to its operators than **Cro** does.

The α -3 helix of **cI** is called the recognition helix, because when **cI** is bound to DNA, its position deep within the major groove allows it to contact specific DNA bases and hence to determine sequence specificity of binding. The α -2 helix is in contact primarily with DNA phosphates. These electrostatic contacts strengthen binding but do not contribute to specificity.

Amino acids and DNA binding - Amino acid sequence homologies among the DNA binding regions for **Cro** and **cI** are shown in **Figure 26.30**. The sequences, though similar, are not identical, which explains how **Cro** and **cI** repressors differ in their relative affinities for different operators. The residues common to both proteins are in contact with DNA sequence elements common to all of the operators (**Figure 26.31**). In both proteins a glutamine residue interacts with one A-T base pair, as shown. **cI** repressor, which binds most strongly to OR1, establishes specificity through a contact in OR1 with a unique alanine residue, whereas **Cro**, which binds most strongly to OR3, can be in contact with three specific base pairs in OR3 with unique [asparagine](#) and [lysine](#) residues.

See also: [cAMP receptor protein \(CRP\)](#), [trp Operon Regulation](#)

INTERNET LINKS:

1. [Helix-Loop-Helix Binding Domains](#)
-

Figure 28.23: Structures of three common types of DNA-binding motifs from eukaryotic transcription factors.

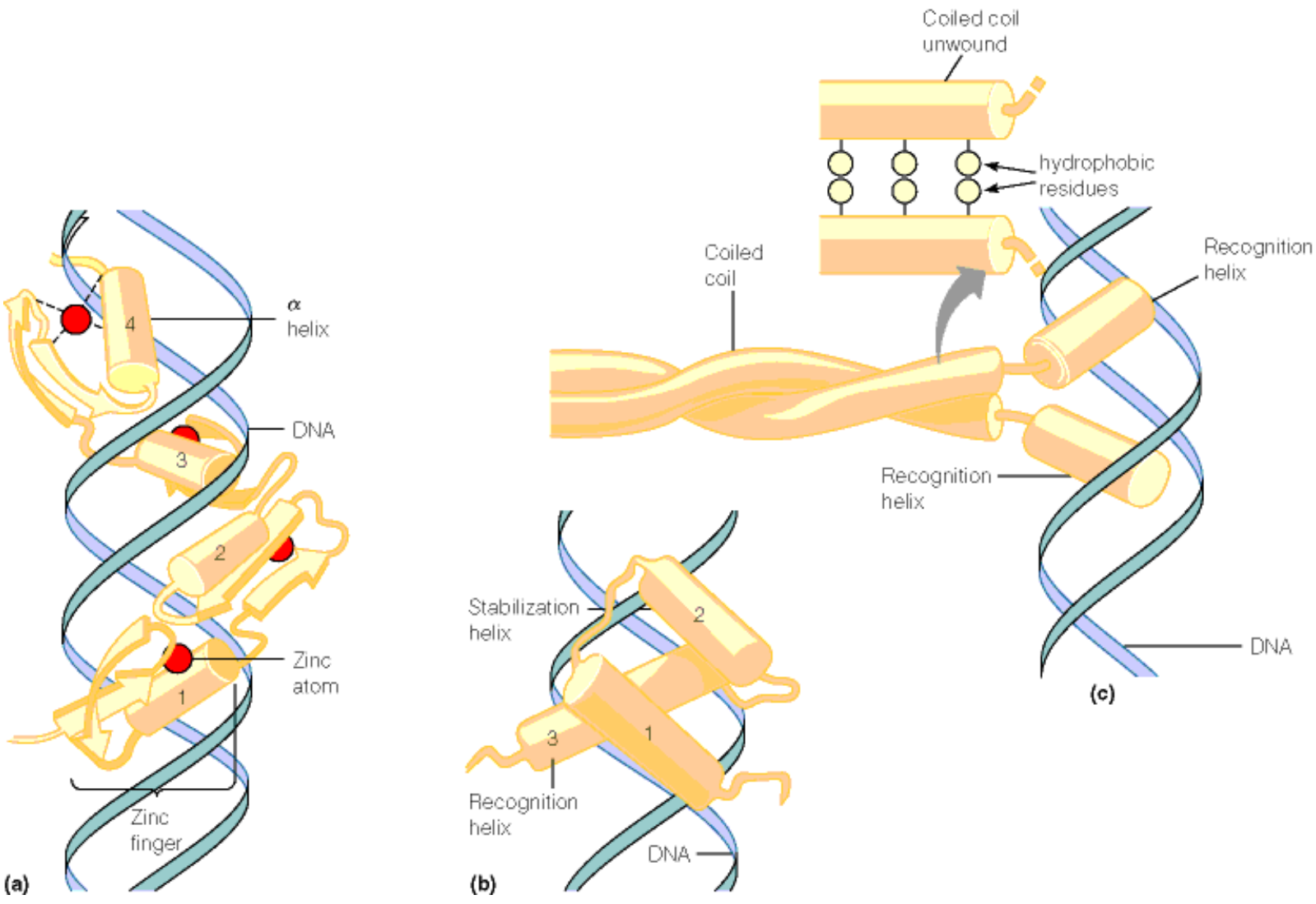

RNA Polymerase III Transcription

RNA polymerase III (pol III) is the largest and most complex of the eukaryotic [RNA polymerases](#). It involves 14 subunits, totaling 700,000 daltons. All of the genes it transcribes are small, they are not all translated into proteins, and their transcription is regulated by certain sequences that lie within the transcribed region. The major targets for **pol III** are the genes for all the tRNAs and for the 5S ribosomal RNA. Like the major ribosomal RNA genes, these small genes are present in multiple copies, but they are usually not grouped together in tandem arrays, nor are they localized in one region of the nucleus. Rather, they are scattered over the genome and throughout the nucleus.

5S Ribosomal RNA genes - The most thoroughly studied genes transcribed by **RNA polymerase III** are those for 5S ribosomal RNA. At least three protein factors in addition to **polymerase III** are needed for the expression of the 5S rRNA genes in vitro. Two of these transcription factors (TFIIIB and TFIIIC) appear to participate in the transcription of tRNA genes as well, but one (called TFIIIA) is specific for the 5S genes.

Transcription factors - The interaction of the three transcription factors, the polymerase, and the gene is shown in [Figure 28.21](#). TFIIIA makes contact with DNA over a length of about 40 bp. This somehow makes the gene accessible to TFIIIB, TFIIIC, and **polymerase III**. TFIIIA can also complex with 5S RNA. This propensity limits 5S RNA production when the product is in excess. TFIIIA is a DNA-binding protein, in which metal-binding zinc "fingers" make contact with and identify DNA sequences ([Figure 28.22](#)). The fingers fit into the major grooves of the DNA, as do the helices in helix--turn--helix and leucine zipper proteins ([Figure 28.23](#); see also [here](#)). TFIIIA is a monomer. TFIIIB is dimeric. TFIIIC is an enormous complex, involving six polypeptide chains and covering the whole 5S rRNA or tRNA gene. Once **pol III** is attached, it can produce multiple transcripts before dissociating.

See also: [Eukaryotic Transcription](#), [Transcription Factor Binding Domains](#)

INTERNET LINKS:

1. [RNA Polymerase III Transcription](#)
-

Figure 28.21: Preparation of a 5S rRNA gene for transcription.

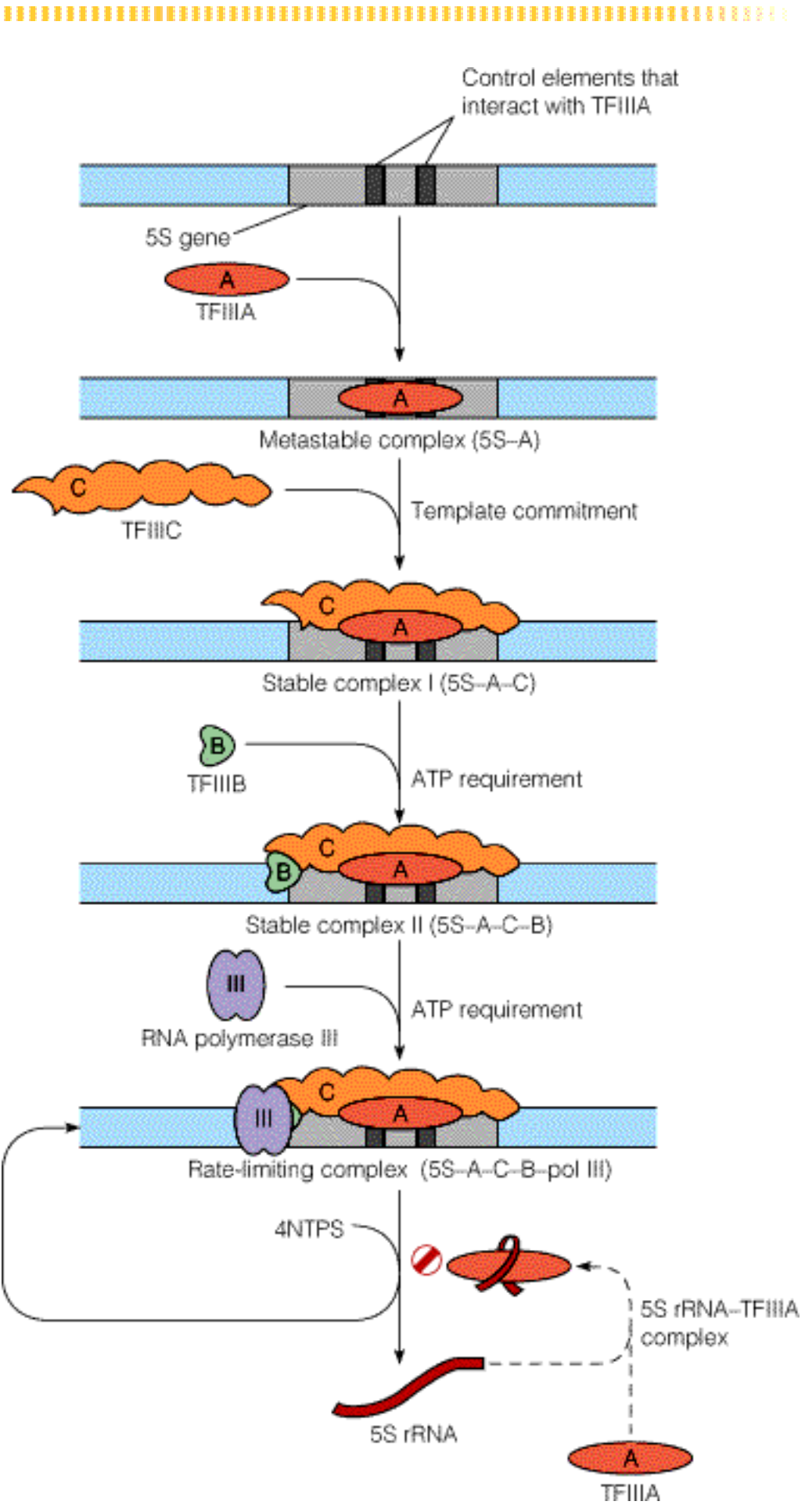

5S rRNA



Figure 28.22: Zinc fingers.

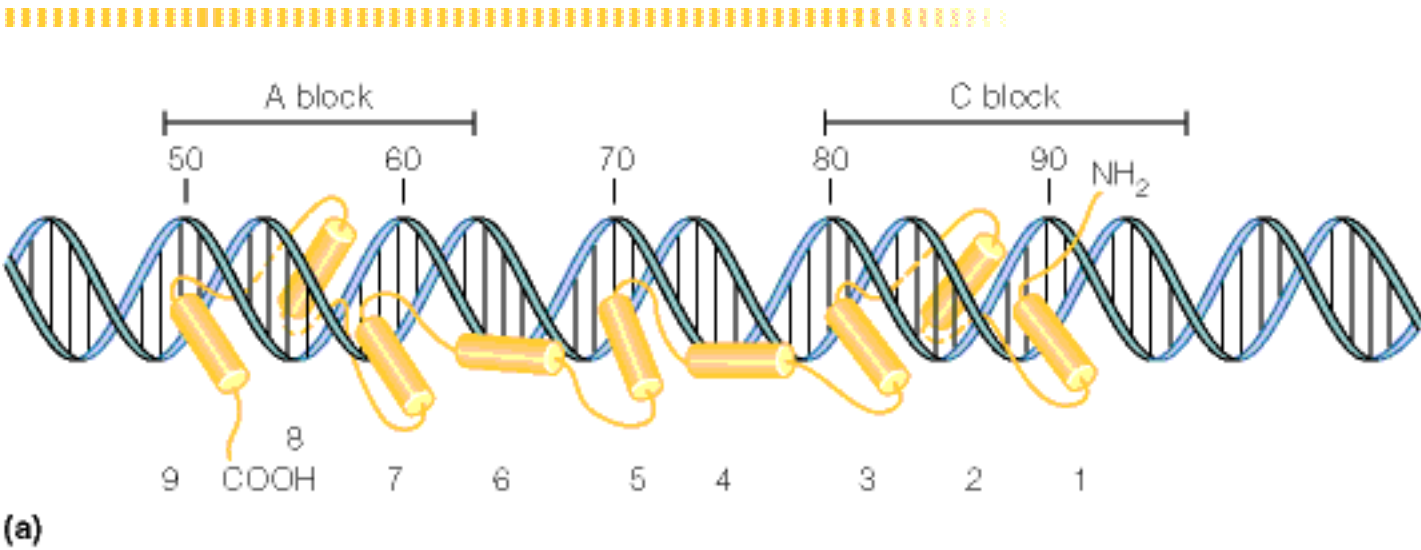

(a)

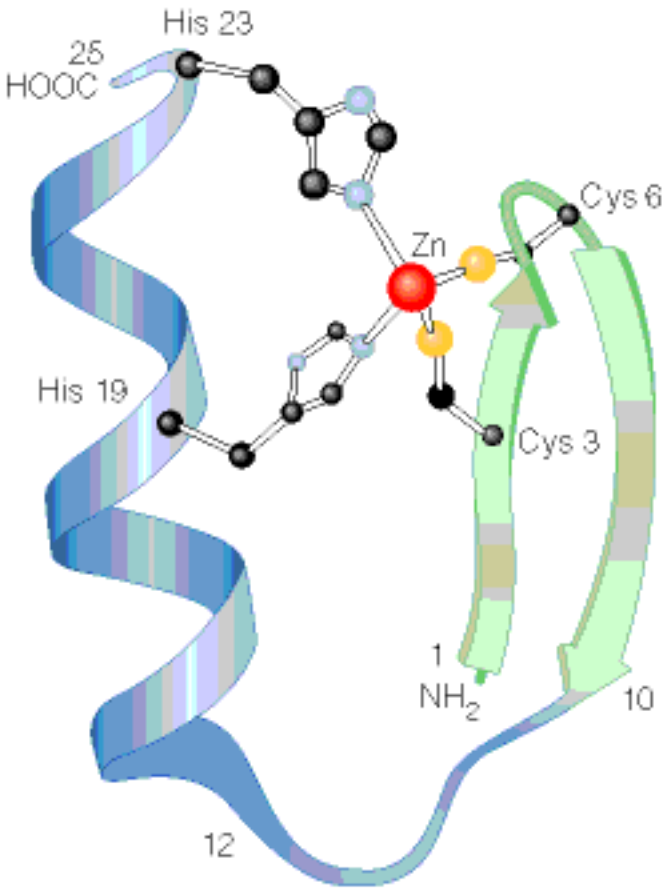

(b)

Adapted from M. S. Lee, G. P. Gippert, K. V. Soman, D. A. Case, and P. Wright, *Science* (1989) 245:635. © 1989 AAAS.

Eukaryotic Transcription

Complexity of transcription - **Transcription** in eukaryotes is a much more complex process than in prokaryotes. Not only is there much more discrimination in what is to be transcribed and what is not, but **transcription** is precisely programmed during development and tissue differentiation. Furthermore, the **transcription** machinery must deal with the complicated levels of structure in eukaryotic **chromatin**.

Proteins - Eukaryotic cells have several different **RNA polymerases**, each with a specialized function (**Table 28.3**). In addition to the special RNA polymerases that function in mitochondria and chloroplasts, there are three enzymes that transcribe various portions of the nuclear genome. Each of the nuclear RNA polymerases contains about a dozen subunits. In contrast to prokaryotic systems, all of the eukaryotic RNA polymerases require additional protein factors (**transcription factors**) in order to bind to a promoter and initiate transcription. Transcription factors seem to play a major role in determining selectivity in the transcription of genes.

See also: [RNA Polymerase I Transcription](#), [RNA Polymerase III Transcription](#), [RNA Polymerase II Transcription](#), [Chromatin Structure and Transcription](#), [Eukaryotic Transcription](#), [Termination of Eukaryotic Transcription](#), [Chromatin Remodeling](#), [Transcription Factor Binding Domains](#)

INTERNET LINKS:

1. [Transcription](#)
 2. [Eukaryotic Promoter Database](#)
-

Table 28.3



Polymerase	Location	RNAs Synthesized
I	Nucleus (nucleolus)	Pre-rRNA (except 5S)
II	Nucleus	Pre-mRNA, some small nuclear RNAs
III	Nucleus	Pre-tRNA, 5S rRNA, other small RNAs
Mitochondrial ^a	Mitochondrion	Mitochondrial
Chloroplast ^a	Chloroplast	Chloroplast

^aThese are quite similar to the prokaryotic RNA polymerase.

Transcription Factor Binding Domains

All of the eukaryotic [RNA polymerases](#) require additional protein factors--**transcription factors**-- to bind to a promoter and initiate transcription. A typical **transcription factor** will contain a DNA-binding domain and one or more regulatory domains, which can interact with other nuclear proteins to convey regulatory signals.

In addition to the zinc-finger proteins, two other major classes of **transcriptional factors** are recognized, and these are depicted schematically in [Figure 28.23](#). In the helix-turn-helix proteins, one helix (called the recognition helix) lies in the major groove of the DNA, its side chains making specific contacts with the DNA bases.

The leucine zipper proteins, on the other hand, are a quite different class of DNA-binding proteins. The leucine zipper proteins are dimers, held together in a coiled-coil structure by hydrophobic interactions. They typically exhibit a regular pattern (7-fold periodicity) of [leucine](#) or other hydrophobic residues in the helical tail regions, which favors side-by-side hydrophobic interactions. The N-terminal regions are recognition helices, lying in adjacent major grooves. Leucine zipper proteins can form either homologous or heterologous dimers, thus allowing many combinatorial combinations in transcription factors.

See also: [Eukaryotic Transcription](#), [RNA Polymerase I Transcription](#), [RNA Polymerase III Transcription](#), [RNA Polymerase II Transcription](#)

INTERNET LINKS:

1. [Transcription Factor Database](#)
 2. [TFIIB Structure](#)
 3. [Eukaryotic Promoter Database](#)
 4. [Nucleic Acid - Protein Binding Motifs](#) (slow)
-

RNA Polymerase I Transcription

Enzyme - RNA polymerase I is a complex enzyme, containing 13 subunits totaling over 600,000 daltons. It is responsible for synthesizing the large 45S pre-rRNA transcript that is later processed into mature 28S, 18S, and 5.8S ribosomal RNAs (**rRNAs**). At least two transcription factors are known to be required, but there is no need for an elaborate transcriptional apparatus characteristic of pol II transcription (see [here](#)), because only a single kind of gene is transcribed.

Ribosome assembly - Eukaryotic ribosomes contain four rRNA molecules. The small ribosomal subunit has an 18S rRNA, whereas the large subunit contains 28S, 5.8S, and 5S rRNA molecules. The nucleolus is the site of ribosomal subunit assembly in eukaryotes. The gene for the 45S pre-rRNA is present in the nucleolus as multiple, tandemly arranged copies, as shown in [Figure 28.20a](#). After transcription, the 45S pre-rRNA is processed to yield 18S, 5.8S, and 28S rRNA molecules. The rRNAs are then combined with 5S rRNA from other regions of the nucleus and ribosomal proteins synthesized in the cytosol. The resulting ribosomal subunits are exported from the nucleolus back into the cytosol.

Transcription of 45S rRNA - Transcription of the tandem copies of 45S pre-rRNA can be beautifully visualized in the electron microscope. It appears likely that nucleosomes are not present in nucleolar chromatin, at least in the transcribed regions. Absence of nucleosomes may be a specific chromatin modification to allow rapid and continuous transcription of these genes.

Autocatalysis by Intron - The 28S rRNA of the protozoan *Tetrahymena*, contains an **intron** near its 3' end. Excision of this intron and splicing of the RNA are carried out by a remarkable process in which the RNA itself acts as the catalyst, via the series of reactions shown in [Figure 11.30](#).

See also: [Eukaryotic Transcription](#), [RNA Polymerases](#) (from Chapter 26), [RNA Polymerases](#) (from Chapter 26)

INTERNET LINKS:

1. [Small RNA Database](#)
2. [The RNA World](#)
3. [RNA Editing](#)
4. [RNA Modification Database](#)



RNA Polymerase II Transcription

Initiation complex - All of the protein-coding genes in eukaryotes are transcribed by **RNA polymerase II (pol II)**. This enzyme also transcribes some of the small nuclear RNAs involved in splicing (see [here](#)). Like other [RNA polymerases](#), **pol II** is a complex, multisubunit enzyme, but not even its numerous subunits are sufficient to allow **pol II** to initiate transcription on a eukaryotic promoter. To form a minimal complex capable of initiation, at least five additional protein factors are needed [Figure 28.24](#) and listed in [Table 28.4](#). The minimal unit involves the TATA binding protein, (TBP), but in vivo formation of the complex probably always uses TFIID, a multi-subunit structure incorporating both TBP and TATA binding associated factors (TAFs).

Control Elements - A DNA sequence that binds a transcription factor is called a **control element**. The function of the TATA **control element** appears to be to fix the starting point for transcription. But eukaryotic pol II promoters contain much more complex and diverse **control elements**, a few of which are listed in [Table 28.5](#). Because the transcription of genes for proteins must be both tissue specific and developmentally specific, it requires a great deal of regulation. In some cases, transcription must also respond to special signal molecules like hormones. It is common to find, upstream from the TATA box, promoter sequences that bind a variety of *trans*-acting factors. These are proteins synthesized on other genes that enhance or repress the transcription of the gene in question. The **control elements** shown are the general elements listed in [Table 28.5](#).

Enhancers - Often, *trans*-acting factors binding at sequences far removed from the promoter itself--by as much as several kilobase pairs--can influence transcription. Such sequences are called **enhancers**, and their mode of action appears to involve DNA looping, perhaps mediated by [nucleosomes](#), which can bring enhancer-bound proteins into close physical contact with proteins bound to the promoter. Some of the transcription factors shown in [Table 28.4](#) can bind in either promoter or **enhancer** regions. The *trans*-acting factors tend to fall into a small number of classes, each defined by the kind of structural domain that interacts with the DNA. Schematic drawings of three of the better-known types are shown in [Figure 28.23](#).

See also: [Eukaryotic Transcription](#), [Transcription Factor Binding Domains](#)

INTERNET LINKS:

1. [Transcription](#)
2. [Eukaryotic Promoter Database](#)

Figure 28.31: Structure of a small nuclear RNA (snRNA).

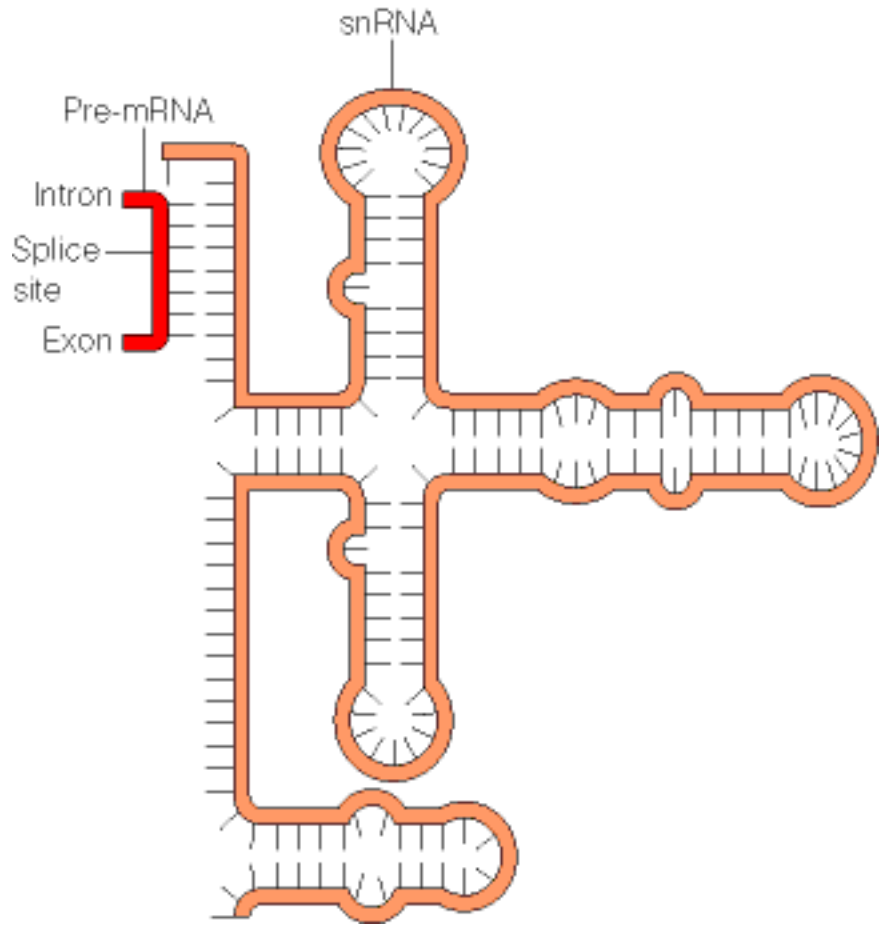
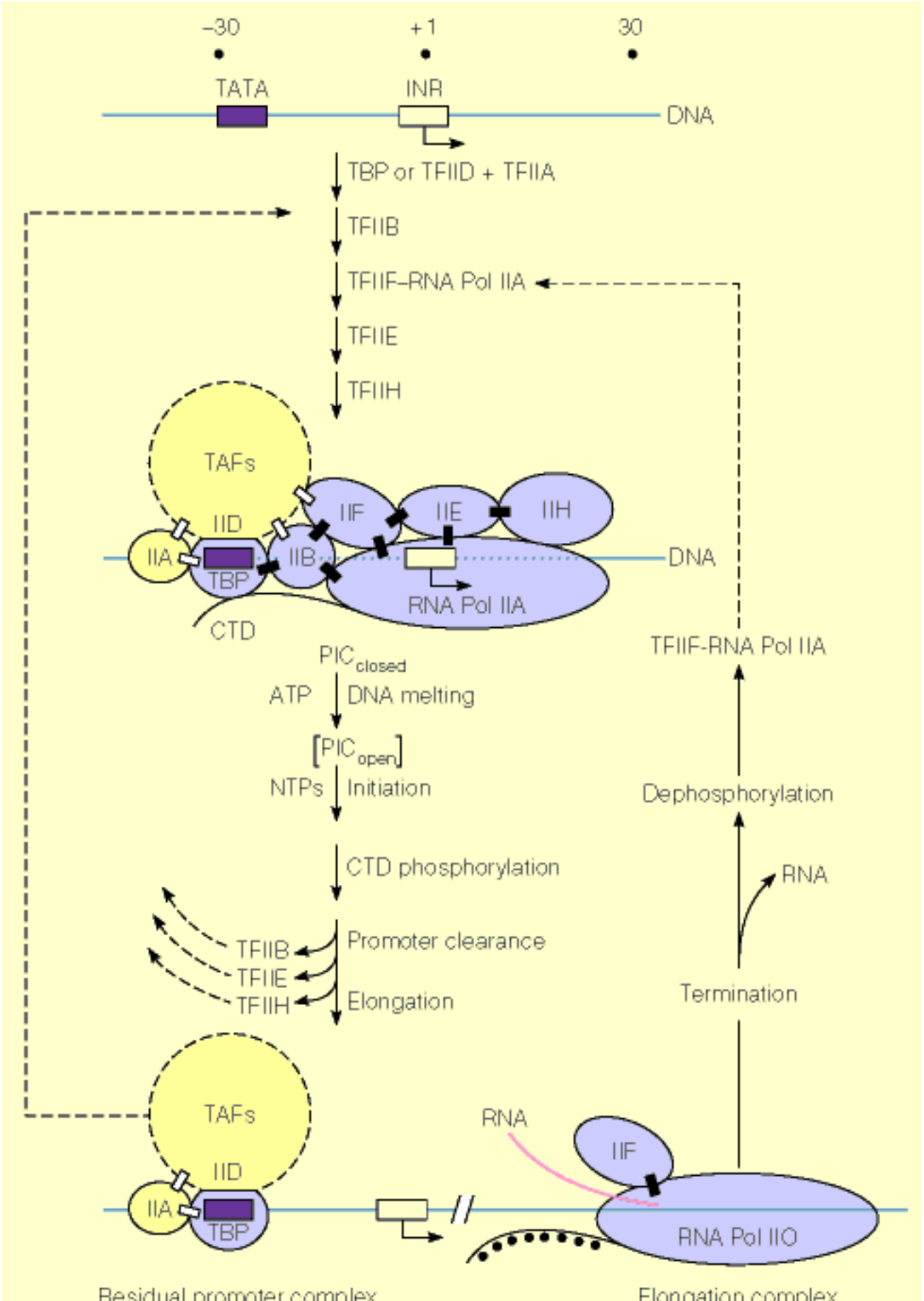

Figure 28.24: A model for the formation of the minimal preinitiation complex (PIC) for pol II on a TATA promoter.





Courtesy of R. G. Roeder, Trends Biochem. Sci. (1996) 21:327-335. © 1996 with permission of Elsevier Science.

Table 28.4



Factor	Number of Subunits	Molecular Weight (kDa)	Function	
TFIID	TBP	1	38	Core promoter recognition (TATA); TFIIB recruitment
	TAFs	12	15–250	Core promoter recognition (non-TATA elements); positive and negative regulatory functions
TFIIA	3	12, 19, 35	Stabilization of TBP binding; stabilization of TAF–DNA interactions; antirepression functions	
TFIIB	1	35	RNA pol II–TFIIF recruitment; start-site selection by RNA pol II	
TFIIF	2	30, 74	Promoter targeting of pol II; destabilization of nonspecific RNA pol II–DNA interactions	
RNA pol II	12	10–220	Catalytic functions in RNA synthesis; recruitment of TFIIE	
TFIIE	2	34, 57	TFIIH recruitment; modulation of TFIIH helicase, ATPase, and kinase activities; direct enhancement of promoter melting (?)	
TFIIH	9	35–89	Promoter melting using helicase activity; promoter clearance (?) by CTD kinase activity	

^a The subunit compositions and polypeptide sizes are those described for the human factors, but homologues for virtually all have also been identified in rat, *Drosophila*, and yeast.

^b Abbreviations used: CTD, carboxy-terminal domain of pol II; RNA pol II, RNA polymerase II; TAFs, TATA-binding protein–associated factors; TBP, TATA-binding protein.

Source: From R. G. Roeder, *Trends Biochem. Sci.* (1996) 21:327–335. © 1996 with permission of Elsevier Science.

Table 28.5



Sequence Name	Consensus Sequence	Transcription Factor(s)	Comment
Some General Promoter and Enhancer Elements			
TATA box	TATAAAA	TBP, TFIID	This is the most common core promoter element
CAAT box	GGCCAATCT	CP1	A common upstream element
GC box	GGGCGG	SP1	Often found in TATA-less promoters
Octamer	ATTTGCAT	Oct1, Oct2	Oct1, Oct2 contain homeo domains
Some Special Promoter and Enhancer Elements			
HSE	CNNGAANNNTCCNNG	Heat shock factor	Involved in heat-shock response
GRE	TGGTACAAATGTTCT	Glucocorticoid receptor	Protein binds glucocorticoid hormones
TRE	CAGGGACGTGACCGCA	Thyroid receptor	Protein binds thyroid hormones

Figure 28.20: Transcription and processing of the major ribosomal RNAs in eukaryotes.

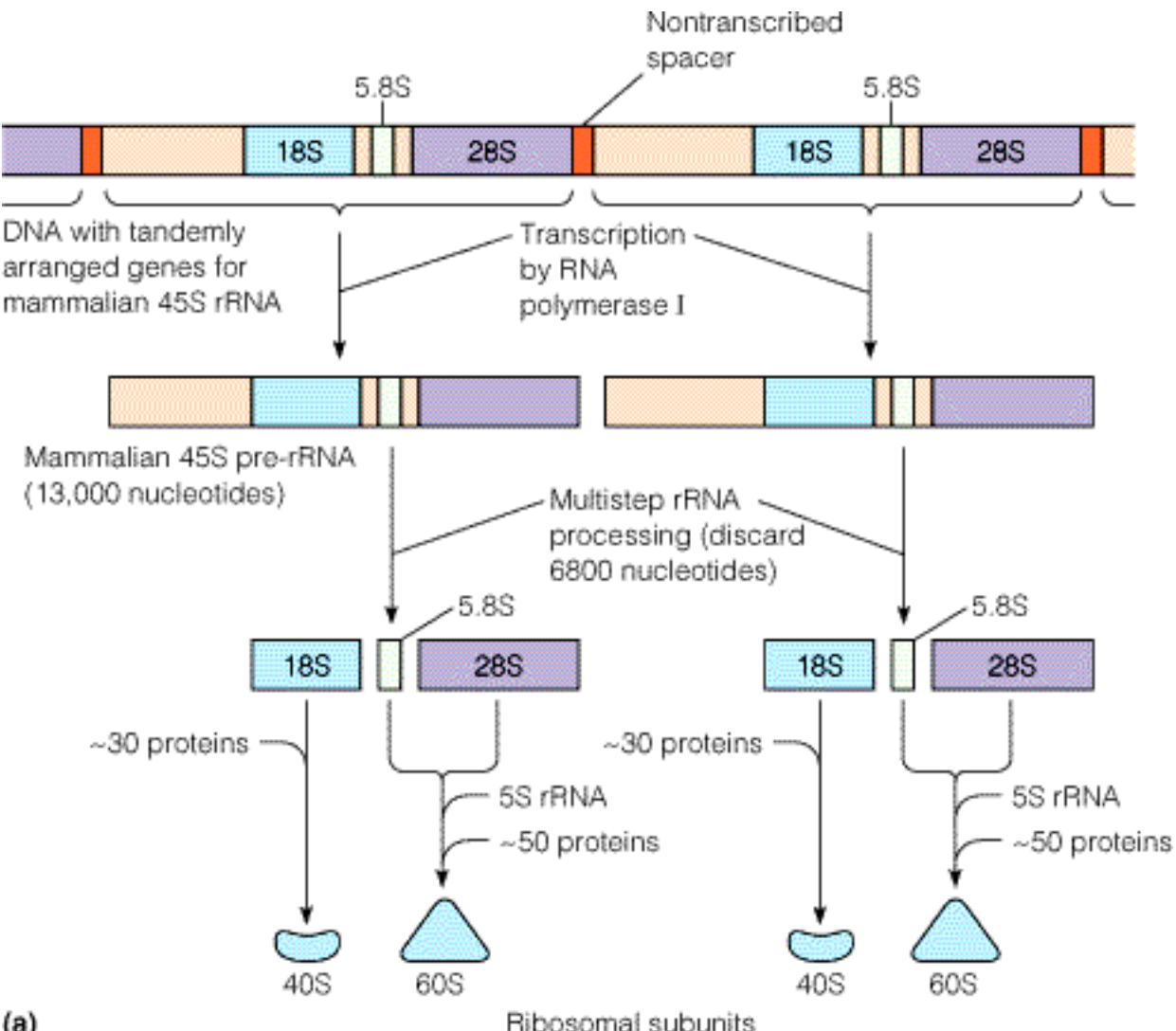

(a)

Introns

Effects on genome size - Eukaryotic genomes may be so large, in part, because most eukaryotic genes in higher eukaryotic organisms are interrupted by **introns** (see [here](#)). For example, the ovalbumin gene codes for a protein 386 amino acid residues in length, which could be accommodated by a message 1158 nucleotides long. The total ovalbumin gene is about 7700 base pairs in length, however, containing eight exons interspersed by seven **introns**. **Introns** are present in most eukaryotic structural genes and frequently exceed exons in total length. Some of the lower eukaryotes like yeast have many fewer **introns**, and their genome size is correspondingly smaller. The smaller yeast genome presumably reflects a need for more efficiency in cell replication.

Intron functions - The function of **introns** is not yet wholly understood. It seems likely that they serve as loci for genetic recombination, allowing functional parts of proteins to be interchanged in evolution. Such loci also allow some eukaryotes to make variants of a protein from a single gene, by splicing different exons together. Alternative splicing is a more efficient way to store information than having a whole gene for each variant of the protein.

See also: [Size of the Eukaryotic Genome](#)

INTERNET LINKS:

1. [Group I Intron Database](#)
 2. [Splice Sites](#)
 3. [Spliceosome](#)
-

The Structure of Eukaryotic Genes

For each polypeptide chain that an organism produces, there exists a corresponding gene. The nucleotide sequence in that gene dictates the amino acid sequence of the protein which, in turn, defines the protein's secondary, tertiary, and quaternary structures.

Introns/Exons - In contrast to the simple organization of prokaryotic genomes, in which individual genes are present as single, uninterrupted coding sequences of DNA, the genes in eukaryotic genomes are organized in a more complex manner. For example, within most eukaryotic genes are DNA sequences that are never translated into polypeptides. These noncoding regions, called **introns**, alternate with regions called **exons** that are expressed in the polypeptide sequence.

β Globin Gene Structure - [Figure 7.20](#) shows how the exon - intron structure of the **β hemoglobin** gene is related to the structure of the **β globin** polypeptide. Only the parts of the gene shown in color correspond to portions of the polypeptide chain.

The process by which eukaryotic mRNA is made is therefore more complicated than the analogous process in prokaryotes.

pre-mRNA - Eukaryotic transcription first produces a primary transcript, or pre-mRNA, corresponding to the whole gene-exons, introns, and portions of flanking regions ([Figure 7.20](#)). The pre-mRNA, while still in the cell nucleus, is cut and spliced to remove the regions corresponding to introns, thereby producing an mRNA that codes correctly for the polypeptide chain. See [here](#) for more information.

See also: [Eukaryotic Transcription](#) (from Chapter 28), [Processing of mRNA](#) (from Chapter 28), [Introns](#) (from Chapter 28)

Figure 7.20: Coding and noncoding regions of the β hemoglobin gene.

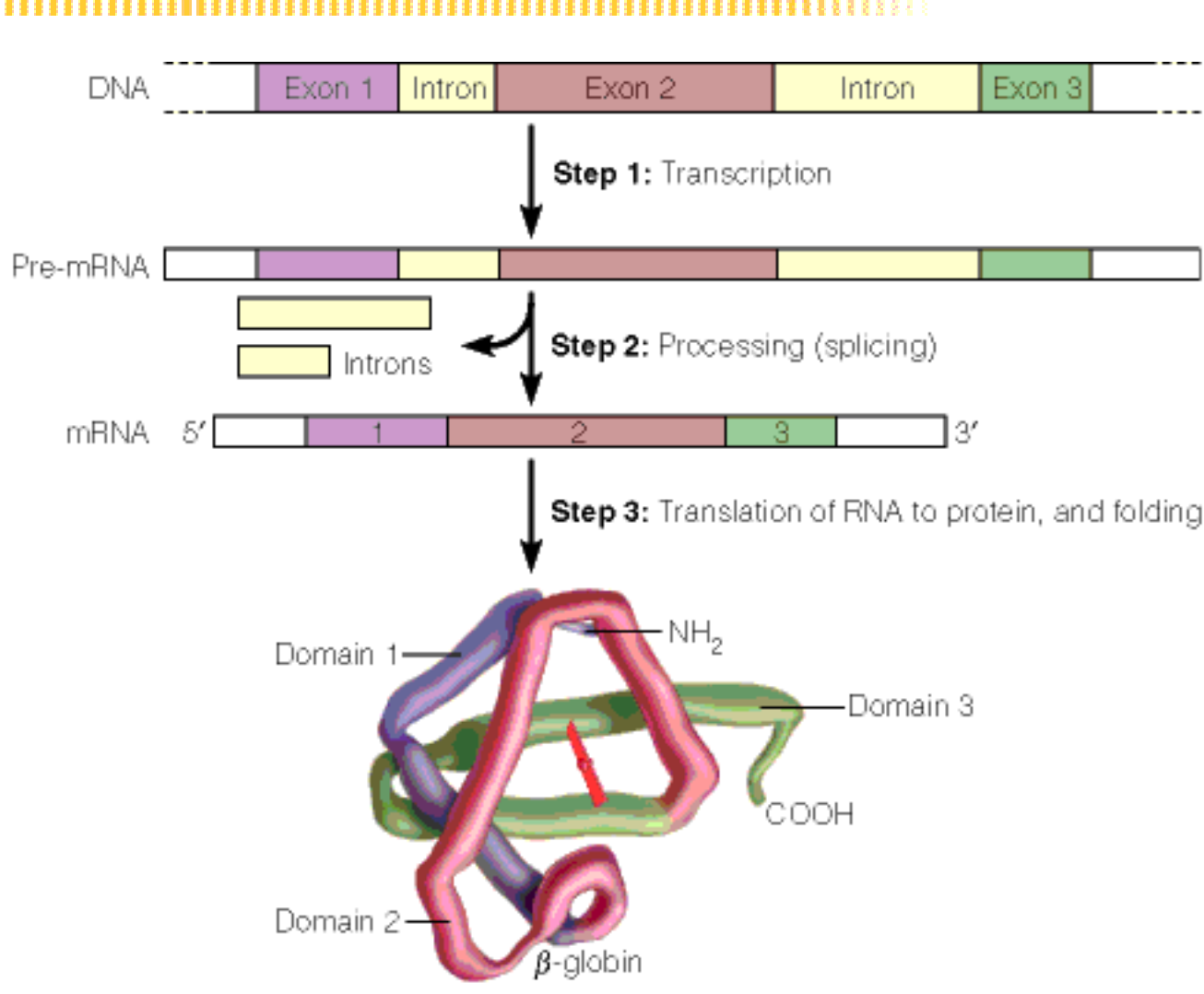

Size of the Eukaryotic Genome

DNA complexity/size - The DNA of higher eukaryotes must code for all of the specialized proteins found in different tissues, so such organisms should have considerably more DNA than is found in a typical prokaryote such as *E. coli*. What is surprising, however, is how much more DNA there actually is. Most eukaryotic cells contain 100 to 10,000 times as much DNA as *E. coli* does ([Figure 28.1](#)).

The only exceptions are found among the lower fungi, such as yeast and *Neurospora*, which do not exhibit the complex tissue differentiation found in higher plants and animals. The profound differences between the genomic needs of multicellular and unicellular organisms is reflected in the genome sizes. The entire yeast genome contains 12.07×10^6 bp, only 2.5 times the size of the *E. coli* genome. It takes at least 10^8 bp to describe an insect, on the other hand, and about 10^9 bp to describe a mammal.

No apparent correlation to organismal complexity - There is no simple correlation between the quantity of DNA in a plant or an animal and the complexity of the organism. An amphibian is certainly no more complex a being than a human, yet some amphibia have genomes over 50 times larger than the human genome. The fact that the human genome must code for many more proteins than a bacterial cell (probably about 20 times as many) cannot alone explain its 1000-fold greater size. Therefore, much DNA is present in eukaryotes that does not code for protein.

See also: [Repetitive Sequences](#), [Introns](#), [Telomeres](#)

INTERNET LINKS:

1. [Yeast Genome Sequence](#)
 2. [E. coli Genome Center](#)
 3. [Human Genome Project](#)
 4. [Genome Organization](#)
-

Repetitive Sequences

In eukaryotic DNA, some DNA sequences are **reiterated** as many as 10^5 to 10^6 times in each cell. Whereas practically all of the DNA of *E. coli* is single-copy (sequences present only once in the genome), only about half of mammalian DNA and about a third of plant DNA fall into this category.

Satellite DNA - Satellite DNA is one type of **repeating sequence** in eukaryotic DNAs. It involves multiple tandem repetitions, over long stretches of DNA, of very short, simple sequences like (ATAAACT)_n. Such DNA can often be separated from the major portion of the DNA by sedimentation to equilibrium in density gradients ([Figure 28.3](#)). In higher eukaryotes, satellite DNA usually makes up 10% to 20% of the total genome. The function of highly **reiterated sequences** is not completely clear. Certain **reiterated sequences** have been found to be highly concentrated near the centromeres of chromosomes, the regions where sister chromatids are attached. These may thus serve as binding sites for proteins that attach the spindle fibers in mitosis.

Duplication of functional genes - There are other classes of DNA sequences with varying amounts of **repetition**. Some represent duplications of functional genes, and in many cases the **repetitiveness** seems to play a useful role, by allowing high levels of production of much-needed transcripts. Examples include the genes for [ribosomal RNAs](#), of which up to several thousand copies may be present, and [tRNA](#) genes, with hundreds of copies of each type often found. The same is true for the genes for some much-used proteins, such as the [histones](#) that bind to eukaryotic DNA to form the chromatin structure (see [here](#)). Even genes that are normally single-copy are sometimes amplified, either in response to environmental stress or in special tissues during embryonic development.

Alu Elements - Other kinds of repeated DNA sequences exist that do not code for proteins, but whose true function remains mysterious. They are often scattered throughout the genome, rather than being clustered like the satellite DNAs. One of the most common such families in mammals is the so-called *Alu* elements. These sequences, of which there are hundreds of thousands of copies in the human genome, are about 300 bp long. The *Alu* sequences can be (inefficiently) transcribed into RNA, although they are not translated. The function of the *Alu* sequences remains uncertain, although some of them may contain origins for DNA replication (see [here](#)).

Molecular Parasites - It is also conceivable that many repetitive sequences, such as the *Alu* elements, serve no useful function. They may simply exist in the genome as "molecular parasites." A way in which such sequences could spread through the genome has been proposed, on the basis of the observation that *Alu* sequences are flanked by short, repeated oligonucleotides resembling those of transposons (see [here](#)). In this view, *Alu* sequences, like other mobile genetic elements, may be inserted at various places in the genome as [reverse transcriptase](#) copies of the RNA that is transcribed from them. Recent studies suggest that the *Alu* sequences may have been derived from a small RNA (7SL RNA - see [here](#)) involved in protein transport across membranes.

See also: [Protein Targeting](#), [Size of the Eukaryotic Genome](#), [Gene Amplification](#) (from Chapter 25)

INTERNET LINKS:

1. [Repetitive DNA](#)
 2. [Genome Organization](#)
-

Figure 28.3: Satellite DNA.

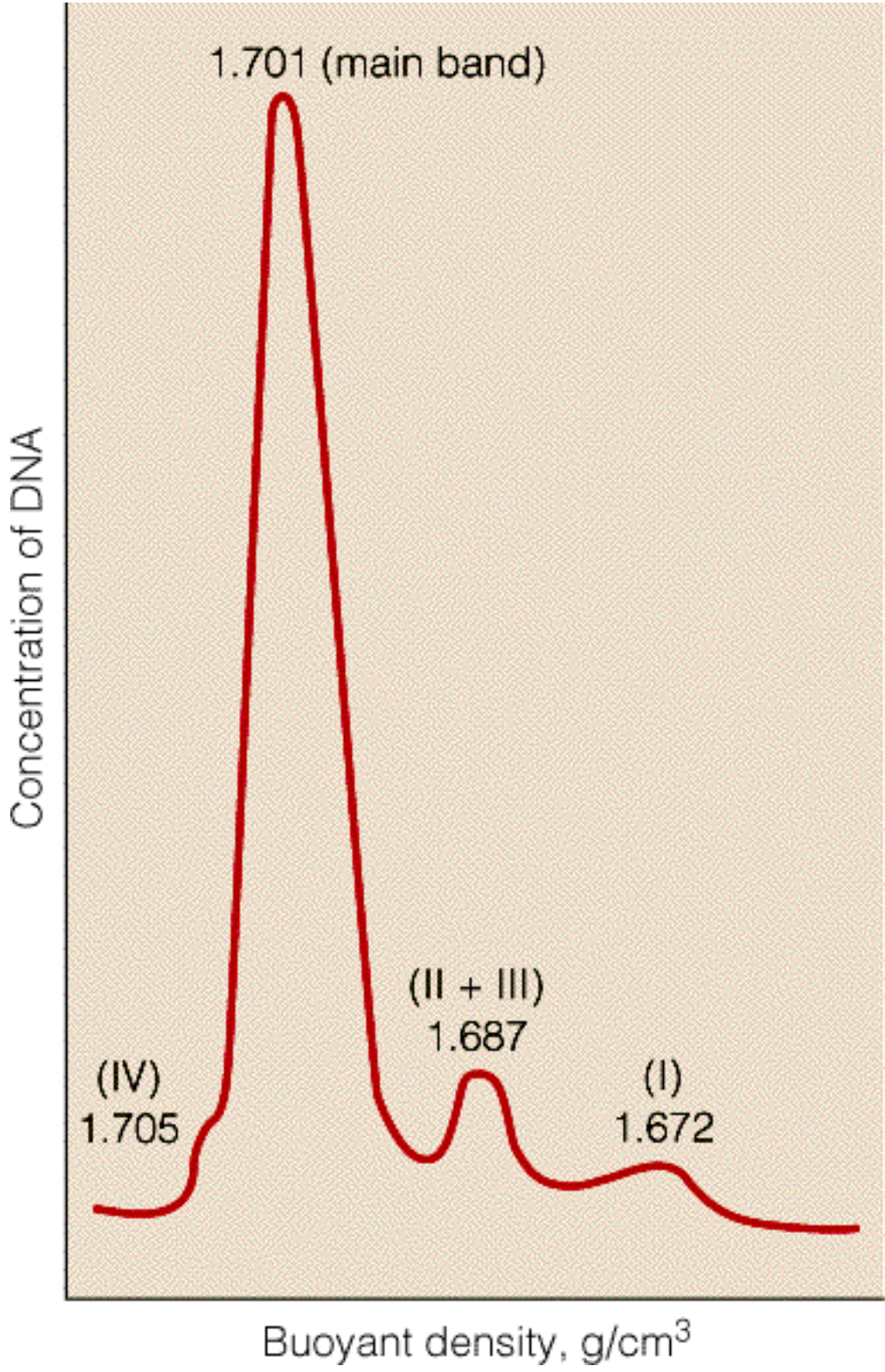

Adapted from S. A. Endow, M. L. Polan, and J. G. Gall, *J. Mol. Biol.* (1975) 96:675.

Figure 28.28: Acetylation of core histones.

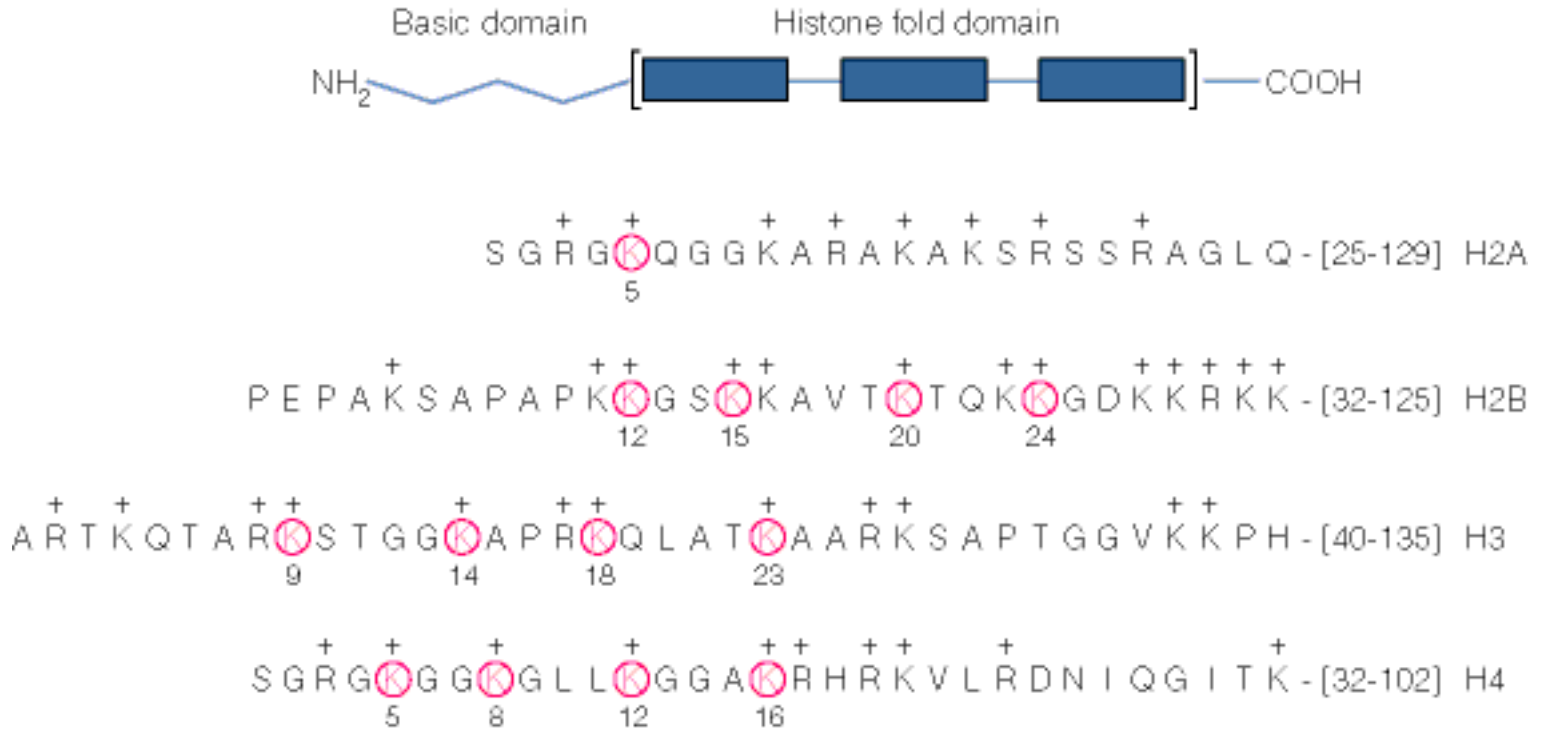

Adapted from J. C. Hansen, C. Tse, and A. P. Wolffe, *Biochemistry* (1997) 37:17637-17641. © 1997 American Chemical Society.

Initiation of DNA Replication

DNA replication is initiated specifically from an origin. **Initiation** appears to be the major target for the control of replication. Two requirements for replication initiation are as follows:

1. A nucleotide sequence that specifically binds initiation proteins, and
2. A mechanism that generates a primer terminus for DNA polymerase to extend.

The two most straightforward ways to generate a primer terminus at the origin are as follows:

1. Nicking a strand of the parental duplex to expose a 3' hydroxyl terminus
2. Synthesizing an RNA primer to expose a 3' hydroxyl ribonucleotide terminus.

E. coli - The **DNA replication origin** of *E. coli* is called *ori^c*. The sequence is 245 base pairs long, with four repeats of a 9-base-pair sequence that binds to an **initiation protein** (the *dnaA* gene product). To the left of these sites, depicted in [Figure 24.37](#), are three direct repeats of a 13-base-pair sequence that is rich in A and T and is thus denatured relatively easily. The sequence also contains binding sites for several basic proteins (HU and IHF) that facilitate DNA bending, an important step in the sequence leading to **initiation**. Steps in the process are as follows:

1. Binding of 10-20 molecules of a DnaA/ATP complex. This causes the DNA to bend. Bending the DNA unwinds the 13-base pair regions. DnaA is activated for this step by reacting with a phospholipid called [cardiolipin](#).
2. The DnaC/DnaB protein complex binds to both forks of the opened loop. The helicase (DnaB) acts to open the structure further.
3. DnaG (primase) binds and synthesizes RNA primers. RNA polymerase may also synthesize some primers.
4. DNA polymerase III holoenzyme extends both leading and lagging strands.

Mitochondria - [Figure 24.39](#) illustrates the unusual DNA replication initiation scheme employed by animal cell mitochondria. This involves two unidirectional replication processes.

1. **Initiation** occurs at a fixed origin on the L strand.
2. The heavy strand is displaced by replication on the L strand
3. About $\frac{2}{3}$ of the way around the circle, a second origin is exposed on the displaced H

strand.

4. Unidirectional synthesis from the second origin proceeds back in the other direction.

The mitochondrial system, with its two unidirectional modes, avoids the need to simultaneously synthesize leading and lagging strands. As a result, both strands are made in a continuous fashion--no Okazaki fragments.

See also: [Replication of Linear Genomes](#)

INTERNET LINK: [Regulation of Eukaryotic DNA Replication](#)

Figure 24.37: A model for initiation of *E. coli* DNA replication at *ori^C*.

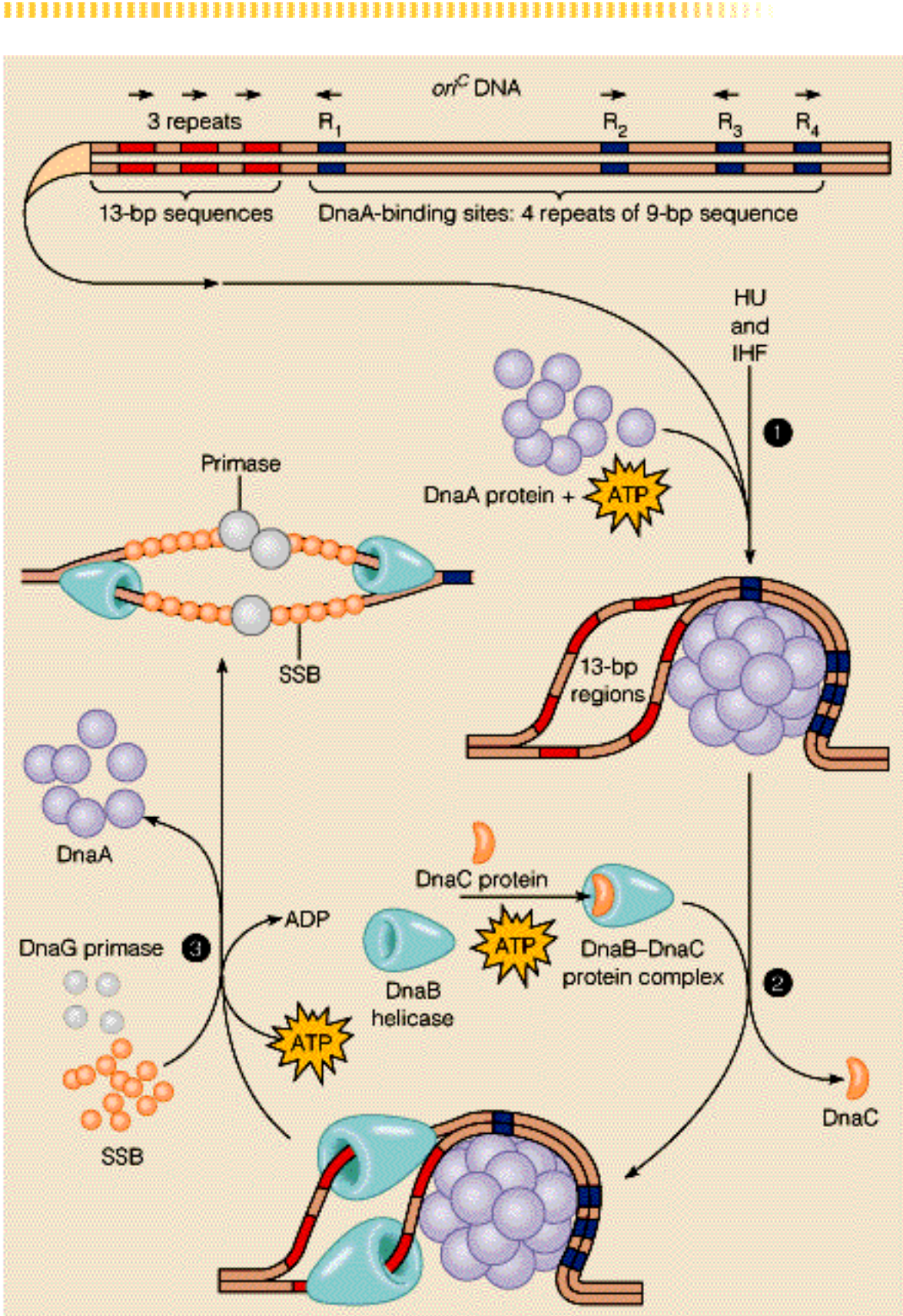

Phosphatidic Acid

Phosphatidic Acid (also known as **diacylglycerol-3-phosphate**) is formed by esterification of glycerol-3-phosphate with two fatty acids. **Phosphatidic acid** is an important intermediate in synthesis of fats and glycerophospholipids. In fat synthesis, the phosphate from phosphatidic acid is removed to form 1,2-diacylglycerol and then a third fatty acid is esterified to yield triacylglycerol (fat).

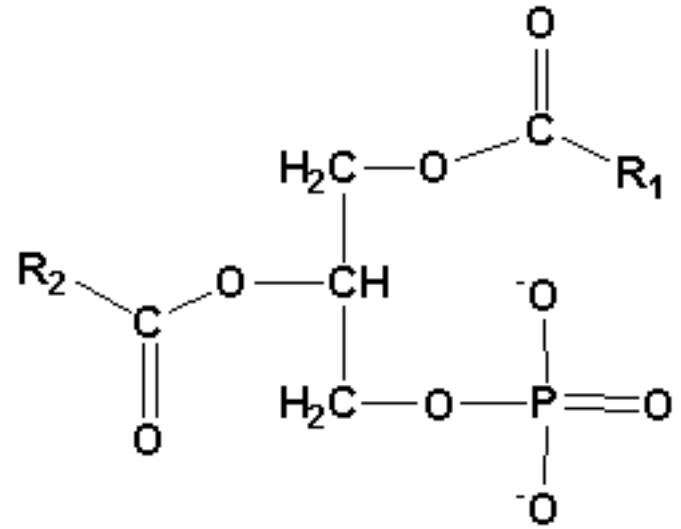

Phosphatidic Acid

See also: [Triacylglycerol Synthesis](#), [Diacylglycerol](#), [Monoacylglycerol](#), [Fatty Acids](#), [Glycerol-3-Phosphate](#), [CDP-Diacylglycerol](#), [Figure 19.3](#), [Glycerophospholipids](#), [Glycerophospholipid Pathway](#)

INTERNET LINKS

1. [Glycerolipid Metabolism](#)
 2. [Phospholipid Catabolism](#)
-

Glycerol-3-Phosphate Dehydrogenase (Gly3PDH)

Gly3PDH catalyzes the oxidation/reduction of glycerol-3-phosphate (Gly3P) and dihydroxyacetone phosphate (DHAP).



Glycerol is generated by digestion of fats and can be converted to glycerol-3-phosphate by the enzyme glycerol phosphate. Conversion of Gly3P to DHAP by **gly3PDH** allows all of glycerol's carbon backbone to enter the glycolysis, gluconeogenesis, or pentose phosphate pathways (via conversion of DHAP to glyceraldehyde-3-phosphate).

See also: [Glycolysis](#), [Gluconeogenesis](#), [Glycerol](#), [Glycerol Kinase](#), [Pentose Phosphate Pathway](#)

Glycerol-3-Phosphate (Gly3P)

Gly3P is formed from glycerol by ATP-dependent phosphorylation catalyzed by [glycerol kinase](#).



Gly3P is an important part of glycerol metabolism. Glycerol is generated by digestion of fats. Conversion of **Gly3P** to DHAP by the enzyme [glycerol-3-phosphate dehydrogenase](#) adds glycerol's carbon backbone to the glycolysis or gluconeogenic pathways.

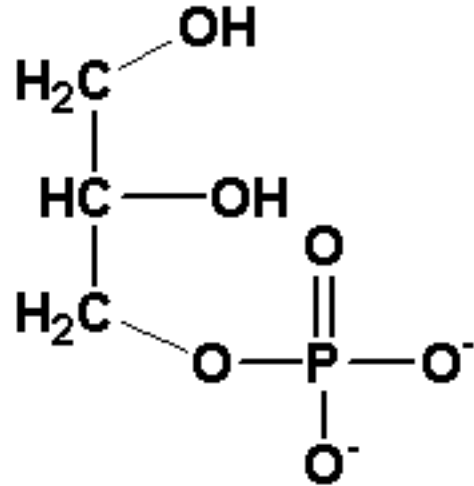

Glycerol-3-phosphate (Gly3P)

See also: [Glycerokinase](#), [Glycolysis](#), [Gluconeogenesis](#), [Phosphatidic Acid](#)

Glycerol Kinase

Glycerol kinase is an important enzyme in glycerol metabolism. Glycerol is produced by breakdown of a fat. One pathway for metabolism of free glycerol depends on the phosphorylation of glycerol provided by **glycerol kinase**.



See also: [Glycerol-3-Phosphate Dehydrogenase](#), [Fat](#), [Glycolysis](#), [Gluconeogenesis](#)

CDP-Diacylglycerol

CDP-diacylglycerol is an important intermediate in biosynthesis of the glycerophospholipids (see **Figures 19.2, 19.4, 19.8**), leading to synthesis of **phosphatidylserine**,

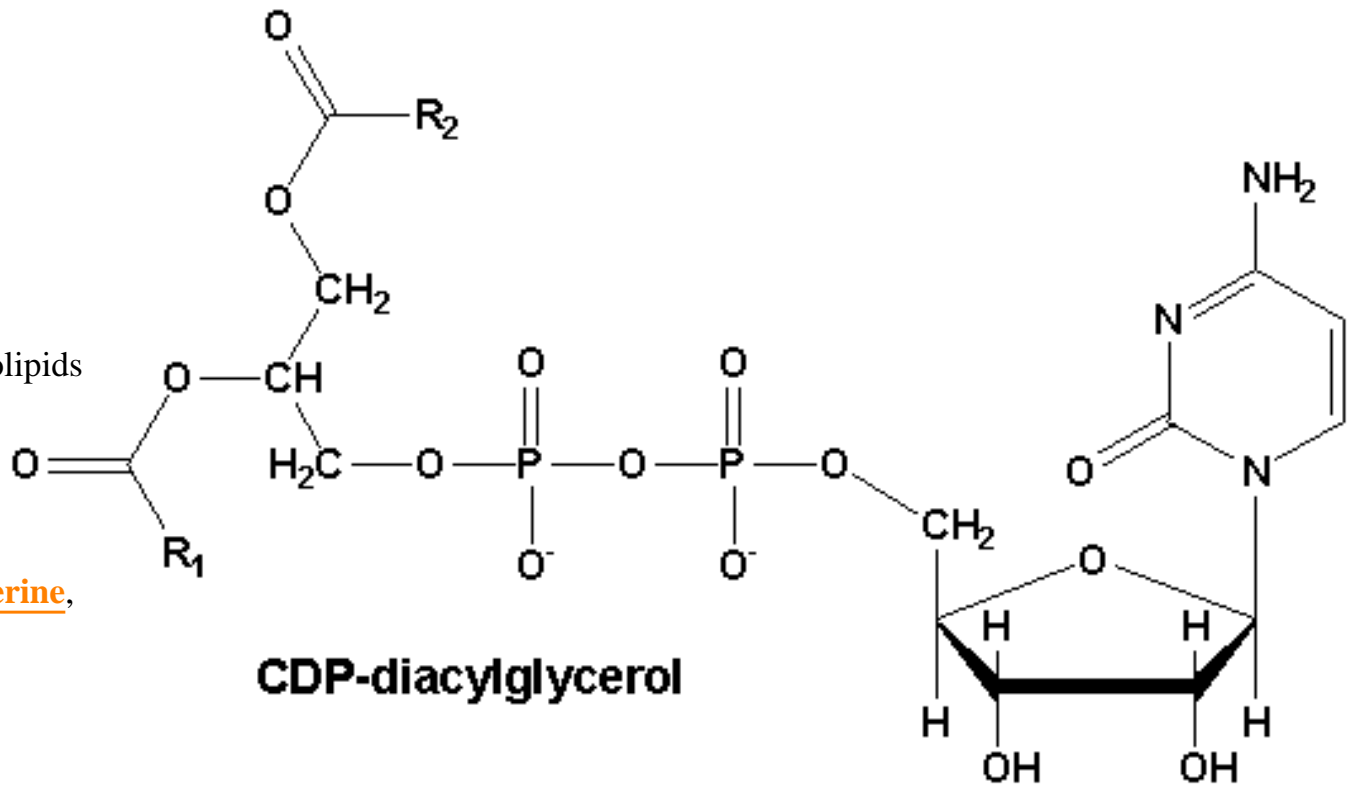

phosphatidylethanolamine, **phosphatidylglycerol**, **cardiolipin**, **phosphatidylinositol**, and **phosphatidylcholine**.

CDP-diacylglycerol is made by combining **phosphatidic acid** and **CTP** (**Figure 19.3**). In each of the glycerophospholipid reaction pathways from **CDP-diacylglycerol**, **CMP** is split from the molecule in order to put on the **serine**, **ethanolamine**, **glycerol**, or inositol moieties.

See also: [Glycerophospholipid Pathway](#), [Glycerophospholipid Metabolism in Eukaryotes](#), [Glycerophospholipid Biosynthesis in Bacteria](#), [Glycerophospholipids](#)

INTERNET LINKS

1. [Glycerolipid Metabolism](#)
 2. [Phospholipid Catabolism](#)
-

Figure 19.2: Pathways in glycerophospholipid biosynthesis.

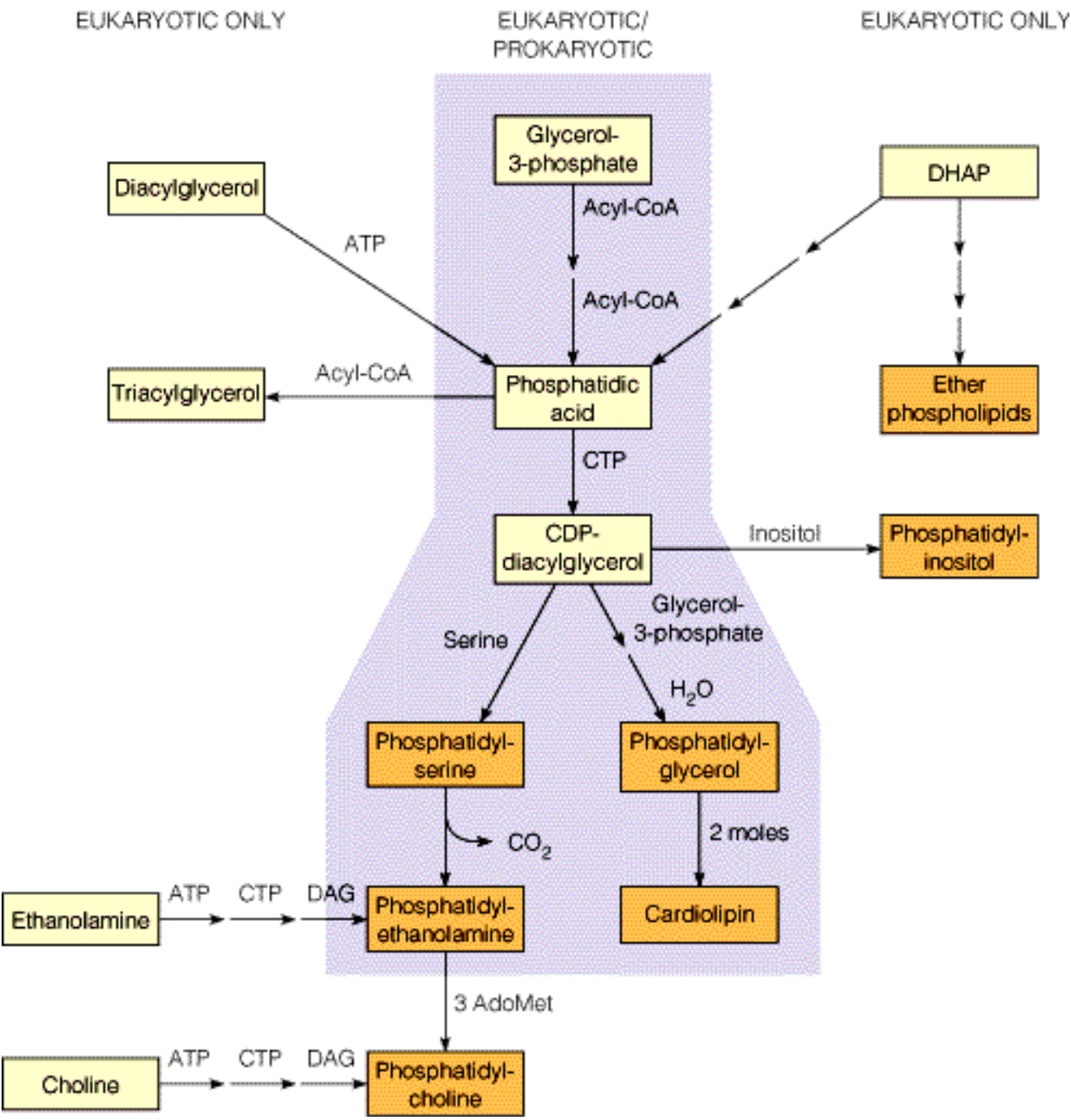
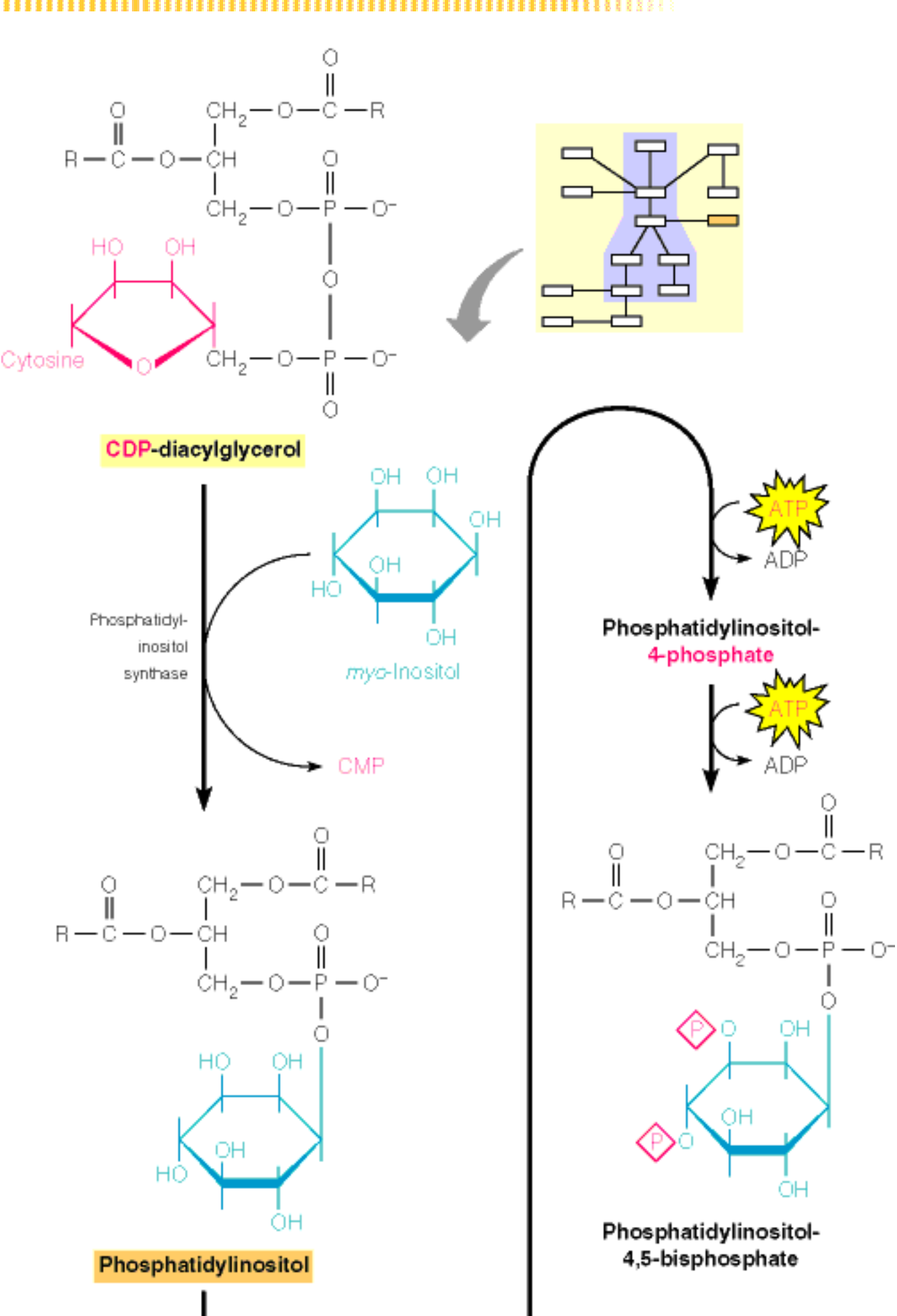

Figure 19.8: Biosynthesis of phosphoinositides.



OH

Phosphatidylinositol

Phosphatidylinositol-
4,5-bisphosphate



Phosphatidylserine

Phosphatidylserine is a glycerophospholipid **CDP-diacylglycerol**. Its biosynthetic reactions are shown in **Figure 19.4**, **here**, and the reaction below:

CDP-Diacylglycerol +
Glycerol-3-Phosphate (or
Myoinositol or **Serine**) \rightleftharpoons
**Phosphatidylglycerol-3-
Phosphate** (or
Phosphatidylinositol or
Phosphatidylserine) + **CMP**

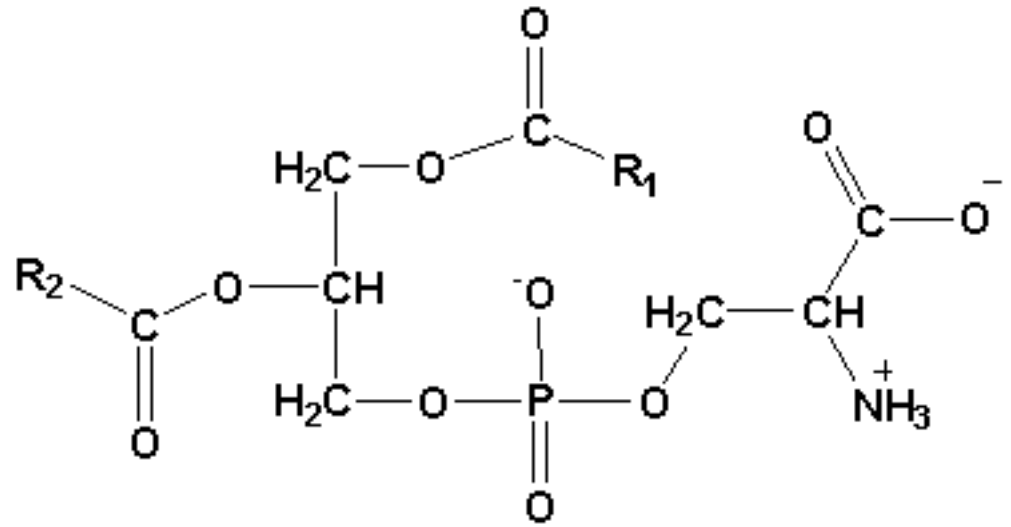

Phosphatidylserine

See also: [Glycerophospholipids](#), [Glycerophospholipid Pathway](#), [Glycerophospholipid Metabolism in Eukaryotes](#)

INTERNET LINKS

1. [Glycerolipid Metabolism](#)
 2. [Phospholipid Catabolism](#)
-

Unnumbered Item

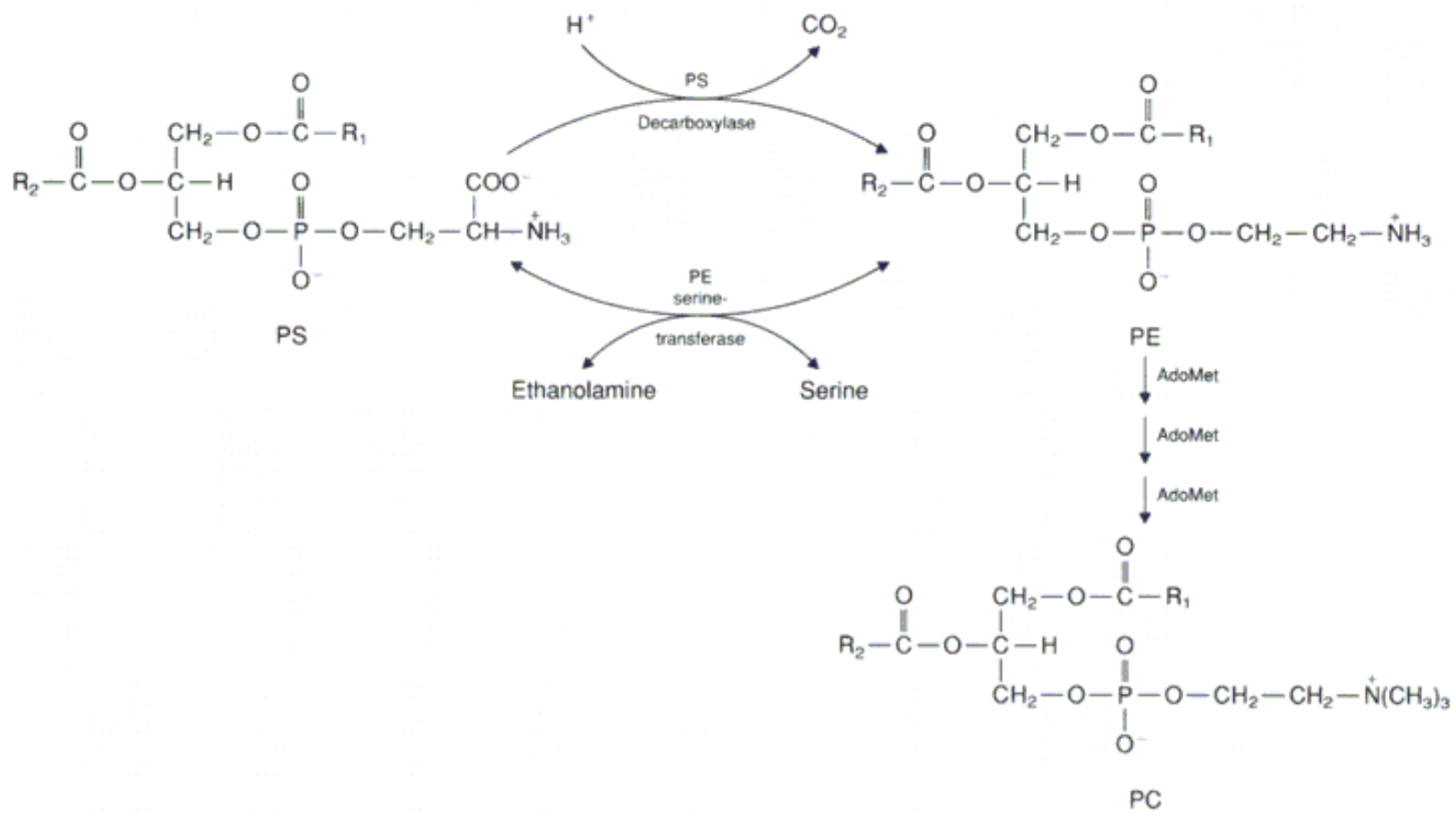

Phosphatidylglycerol-3-Phosphate

Phosphatidylglycerol-3-phosphate is an intermediate in synthesis of **cardiolipin**. It is made by addition of glycerol-3-phosphate to CDP-diacylglycerol (**Figure 19.4**) in the reaction that follows.

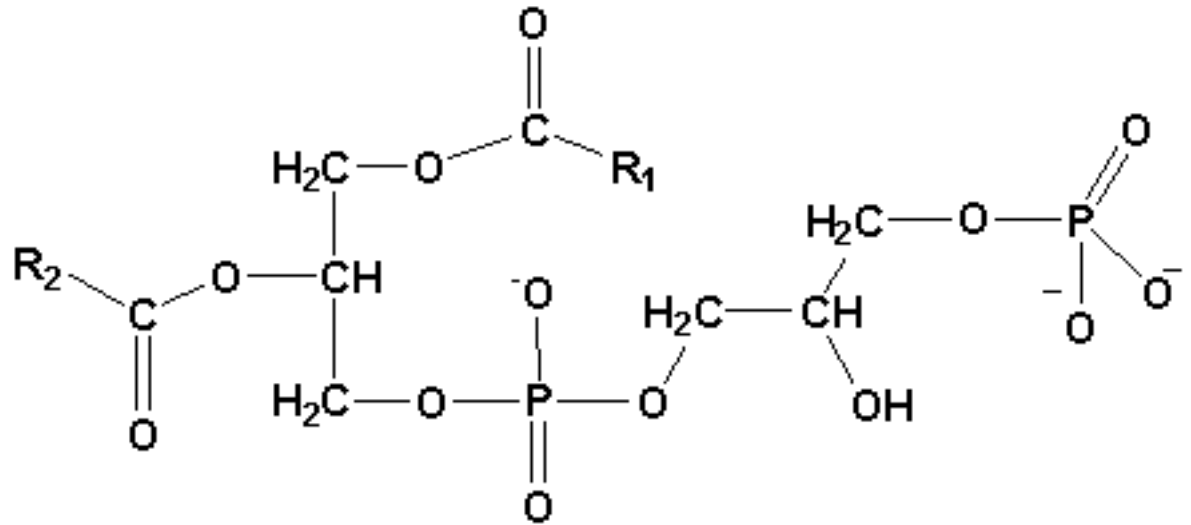

Phosphatidylglycerol-3-phosphate

CDP-Diacylglycerol + **Glycerol-3-Phosphate** (or Myoinositol or **Serine**) \rightleftharpoons **Phosphatidylglycerol-3-Phosphate** (or **Phosphatidylinositol** or **Phosphatidylserine**) + **CMP**

Subsequently, the external phosphate is hydrolyzed to make phosphatidylglycerol, which is then joined with another phosphatidylglycerol to make cardiolipin (**Figure 19.4**).

See also: [Glycerophospholipid Pathway](#), [Glycerophospholipid Biosynthesis in Bacteria](#), [Glycerophospholipids](#), [Glycerophospholipid Pathway](#),

INTERNET LINKS

1. [Glycerolipid Metabolism](#)
 2. [Phospholipid Catabolism](#)
-

Phosphatidylinositol

Phosphatidylinositol is a **glycerophospholipid** that can be made by the reaction shown below:

CDP-Diacylglycerol + **Glycerol-3-Phosphate** (or myoinositol or **serine**) \rightleftharpoons **Phosphatidylglycerol-3-Phosphate** (or **Phosphatidylinositol** or **Phosphatidylserine**) + **CMP**

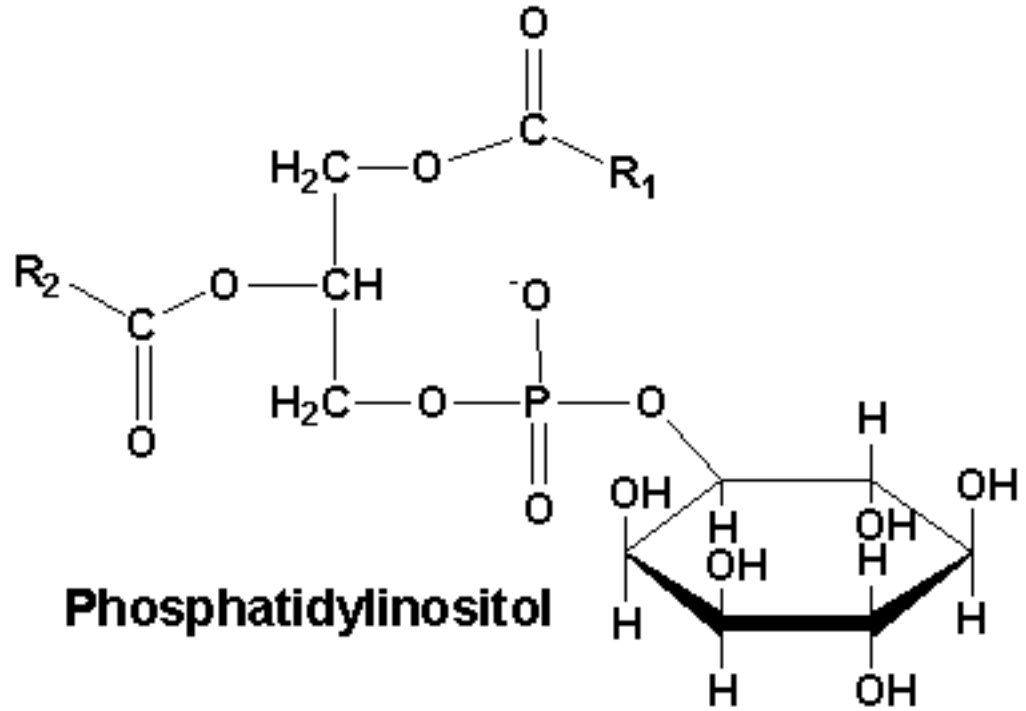

See also: [Glycerophospholipid Pathway](#), [Glycerophospholipid Metabolism in Eukaryotes](#), [Posttranslational Addition of Lipids to Proteins](#), [Second Messenger Systems](#), [Figure 19.8](#)

INTERNET LINKS

1. [Glycerolipid Metabolism](#)
2. [Phospholipid Catabolism](#)

Glycerophospholipids

Glycerophospholipids (also called **phosphoglycerides**) are lipids with a glycerol backbone and a phosphate group, usually on carbon 3 of the glycerol. **Glycerophospholipids** are important compounds in the membranes of cells. The metabolic scheme of glycerophospholipids is shown [here](#). A brief description from Chapter 19 is given [here](#).

See also: [Molecular Structures and Properties of Lipids](#), [Phosphatidic Acid](#), [Cardiolipin](#), [Phosphatidylserine](#), [Phosphatidylethanolamine](#), [Phosphatidylglycerol](#), [Phosphatidylcholine](#), [CDP-Diacylglycerol](#), [Phosphatidylglycerol-3-Phosphate](#), [Phosphatidylinositol](#), [Lung Surfactant](#), [Sphingolipids](#), [Glycosphingolipids](#),

INTERNET LINKS

1. [Glycerolipid Metabolism](#)
 2. [Phospholipid Catabolism](#)
-

Glycerophospholipid Biosynthesis in Bacteria

Figure 19.2 schematically depicts the primary pathways of prokaryotic and eukaryotic **glycerophospholipid** biosynthesis. Note that the center pathway shown in purple occurs in both prokaryotic and eukaryotic cells. **Figure 19.3** shows the molecular synthesis of CDP-diacylglycerol starting from **glycerol-3-Phosphate**.

Phosphatidic Acid, the precursor to **CDP-diacylglycerol**, usually contains two different acyl groups. The fatty acid on carbon 1 of glycerol (R1 in **Figure 19.3**) is saturated about 90% of the time. Conversely, the fatty acid on carbon 2 of glycerol (R2 in **Figure 19.3**) is unsaturated about 90% of the time.

Phosphatidic acid is a branch point between the synthesis of fats and other glycerophospholipids. The high energy anhydride bond between the cytidylic and phosphatidic acid in CDP-diacylglycerol provides an activated intermediate for addition of polar head groups on the phosphate.

One pathway from CDP-diacylglycerol leads to phosphatidylserine (**PS**), phosphatidylethanolamine (**PE**), and phosphatidylcholine (**PC**), as shown in **Figure 19.2** and **Figure 19.4**. A different pathway from CDP-diacylglycerol leads to **phosphatidylglycerol** and **cardiolipin**.

See also: [**Glycerophospholipid Metabolism in Eukaryotes**](#), [**Glycerophospholipid Pathway**](#)

Figure 19.3: Synthesis of phosphatidic acid and CDP-diacylglycerol in bacteria.

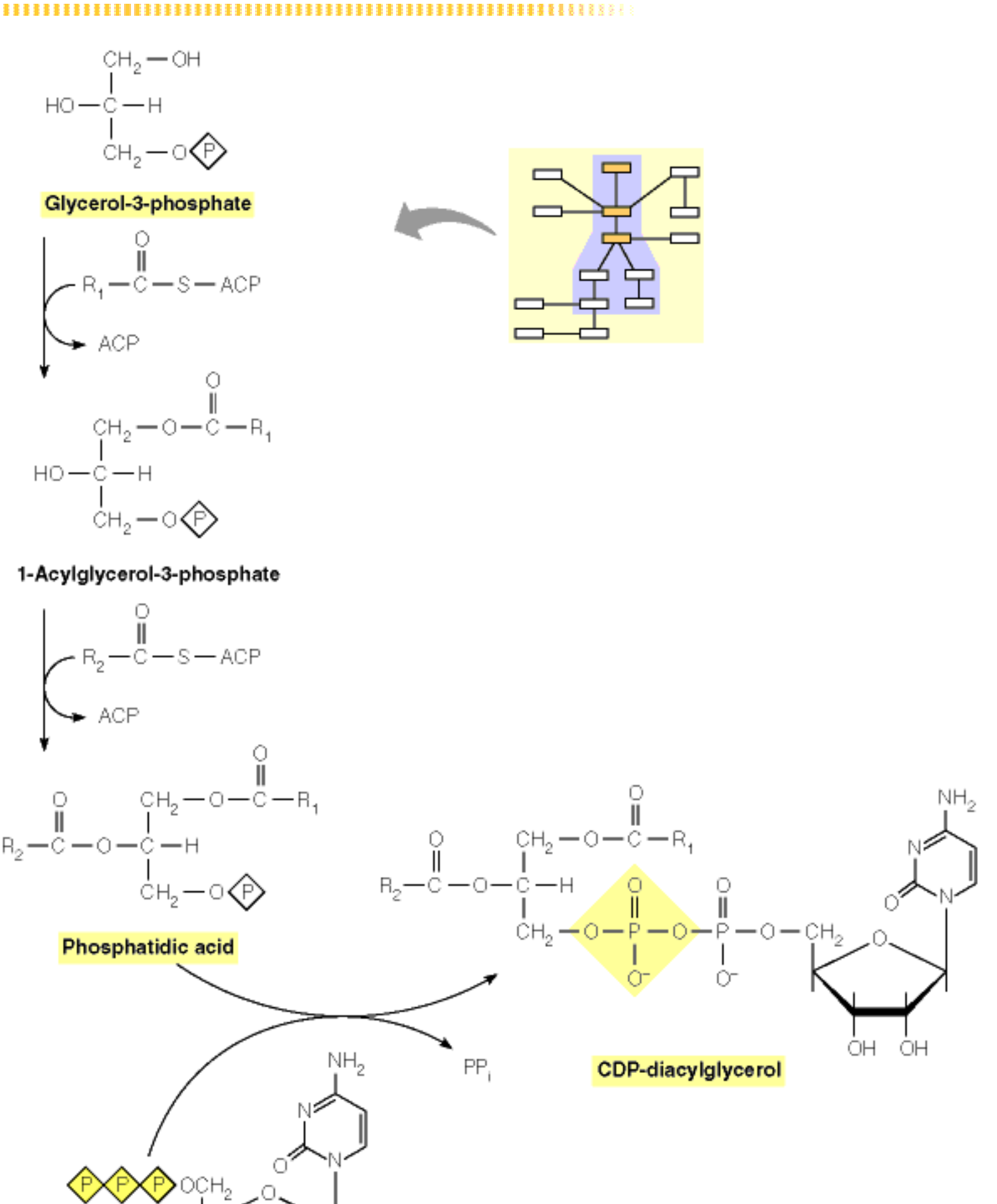

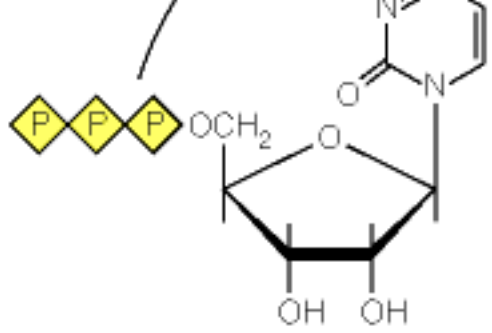

CTP

Phosphatidylethanolamine

Phosphatidylethanolamine is a **glycerophospholipid**. Its biosynthetic reactions are shown in **Figure 19.4** and **here**.

See also: [Glycerophospholipid Pathway](#), [Glycerophospholipid Metabolism in Eukaryotes](#)

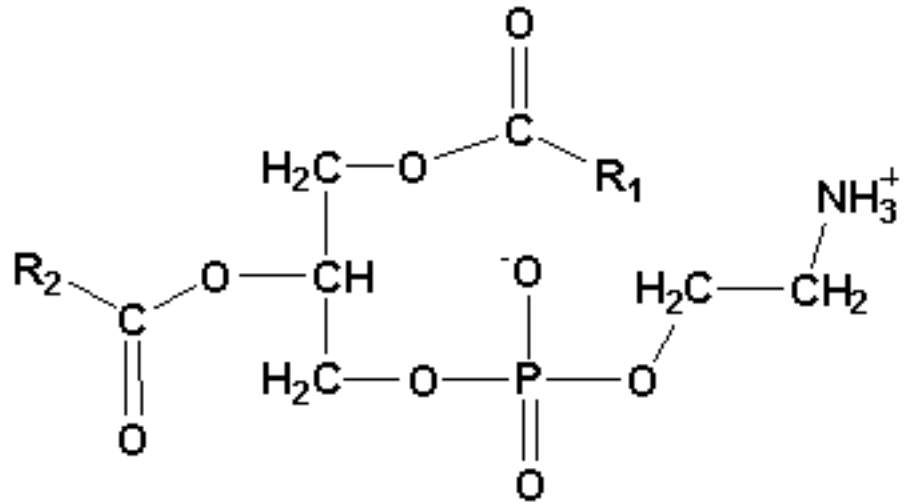

Phosphatidylethanolamine

INTERNET LINKS

1. [Glycerolipid Metabolism](#)
 2. [Phospholipid Catabolism](#)
-

Glycerophospholipid Metabolism in Eukaryotes

Figure 19.2 schematically depicts the primary pathways of prokaryotic and eukaryotic **glycerophospholipid biosynthesis**. Note that the center pathway shown in purple occurs in both prokaryotic and eukaryotic cells. **Phosphatidic acid**, the branch point between the synthesis of fats and other **glycerophospholipids**, can be made via three different pathways in eukaryotes—from glycerol-3-phosphate (**Figure 19.3**), from diacylglycerol (**Figure 19.2**), and from dihydroxyacetone phosphate (**DHAP**) (see [here](#)).

DHAP can also give rise to the ether phospholipids (**Figure 19.2**), which include a class of molecules called **plasmalogens** (**Figure 19.12**) and platelet-activating factor. Plasmalogens are abundant in heart tissue and their deficiency leads to problems with brain, liver, kidney, and an early death. Platelet activating factor (see [here](#)) at very low concentration exerts numerous physiological effects, including inflammation, reduction of blood pressure, and stimulation of uterine contraction.

Phosphatidylcholine (**PC**) can be synthesized in eukaryotes starting from choline (**Figure 19.5**) or from phosphatidic acid via CDP-diacylglycerol, phosphatidyl serine (**PS**) and phosphatidylethanolamine (**PE**). The interconversion of PS, PE, and PC is shown [here](#).

Phospholipid fatty acids may be redistributed, after they are synthesized, in response to varying environmental conditions or needs. Lung surfactant is one such phospholipid with redistributed fatty acids. Lung surfactant contains some 50% to 60% of dipalmitoylphosphatidylcholine, a form of phosphatidylcholine in which palmitoyl chains occupy both positions 1 and 2 on the glycerol. Phospholipids are usually synthesized with an unsaturated fatty acid on position 2, so some modification has likely occurred. **Phospholipases** may be involved in the modification, because they can remove fatty acids from phospholipids.

Lysolecithin is another name for 1-acylglycerophosphorylcholine, which is phosphatidylcholine with the fatty acid at position 2 removed. Lysolecithin is an excellent detergent, capable of solubilizing membranes, and causing cells (such as erythrocytes) to lyse.

Finally, **Figure 19.2** shows that **CDP-diacylglycerol** serves in eukaryotes as a branch point in the synthesis of **phosphatidyl-inositol**, yet another major phospholipid found in membranes.

See also: [Glycerophospholipid Biosynthesis in Bacteria](#), [Redistribution of Phospholipid Fatty Acids](#), [Glycerophospholipids](#), [Glycerophospholipid Pathway](#), [Ether Phospholipids](#),

Unnumbered Item

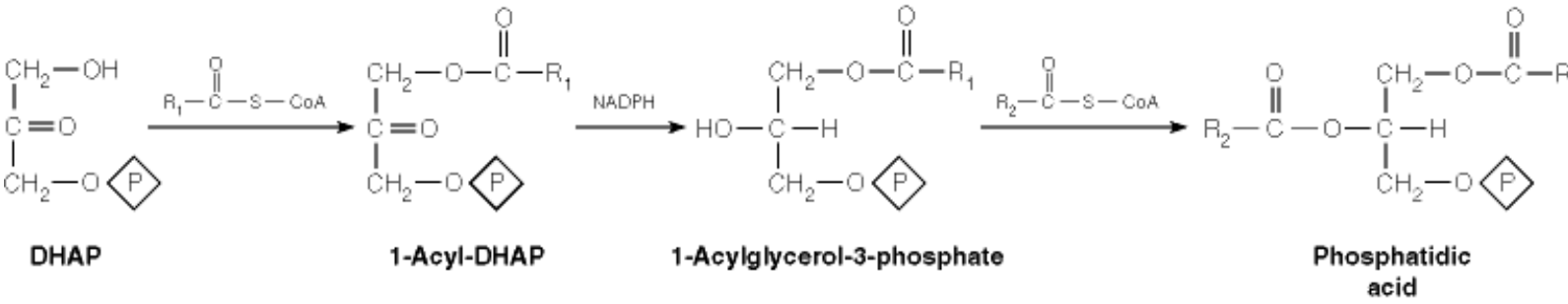

Plasmalogens

Ether phospholipids are lipids containing an alkyl group, rather than an acyl group, linked to one of the oxygen atoms of glycerol (see [here](#)). Metabolic pathways leading to **ether phospholipids** are shown in [Figure 19.11](#) and [Figure 19.12](#).

Plasmalogens (vinyl ethers) are phospholipids containing an alkenyl ether at position sn-1 of glycerol. They are synthesized in peroxisomes ([Figure 19.12](#)) and constitute 50% of all choline phospholipids in heart tissue. Nevertheless, they are virtually undetectable elsewhere in the body. Individuals deficient in plasmalogen synthesis (such as those with Zellweger syndrome) suffer damage to brain, liver, and kidney before reaching an early death.

See also: [Ether Phospholipids](#)

INTERNET LINK: [Zellweger Syndrome](#)

Unnumbered Item

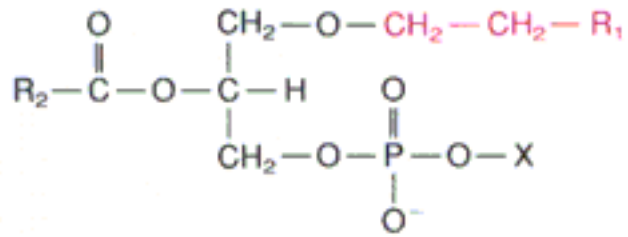

**Phospholipid with an alkyl ether
at position *sn*-1**

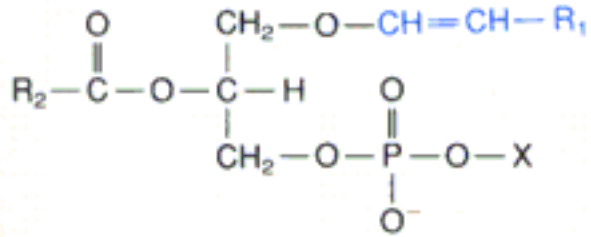

**Phospholipid with an alkenyl ether
at position *sn*-1**

Figure 19.11: Biosynthetic routes to alkyl ether phospholipids.

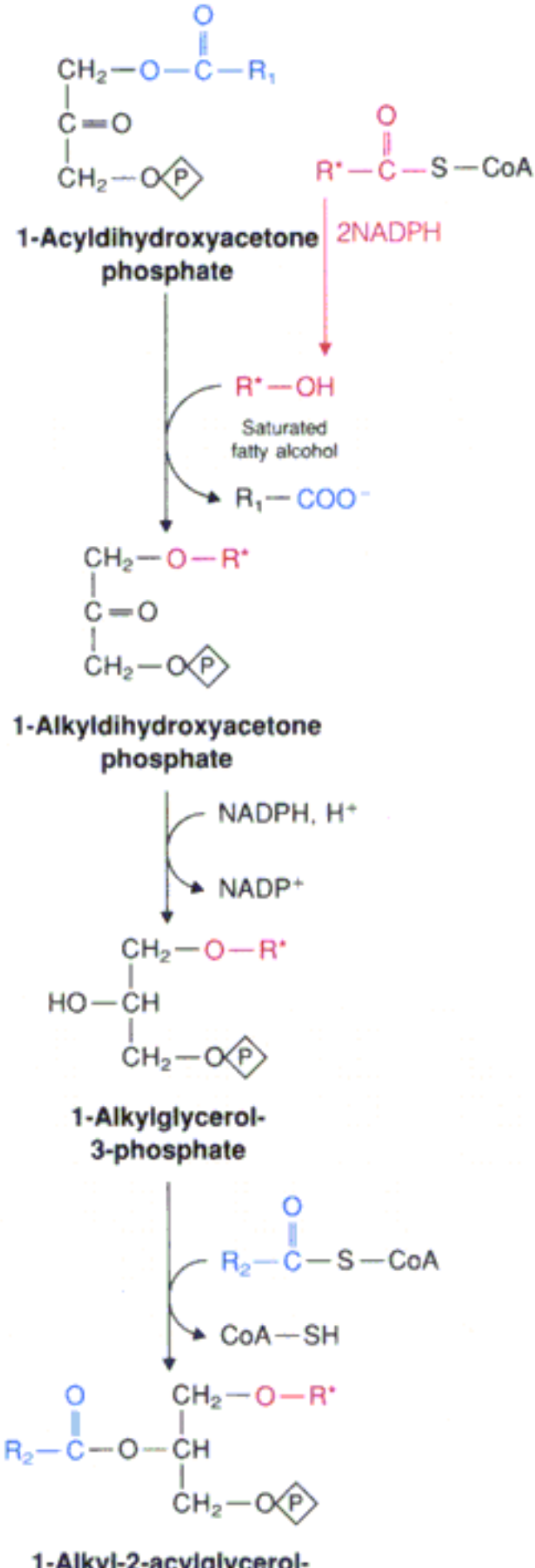

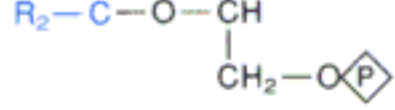

**1-Alkyl-2-acylglycerol-
3-phosphate**

Figure 19.12: Synthesis of a plasmalogen from a glyceryl ether.

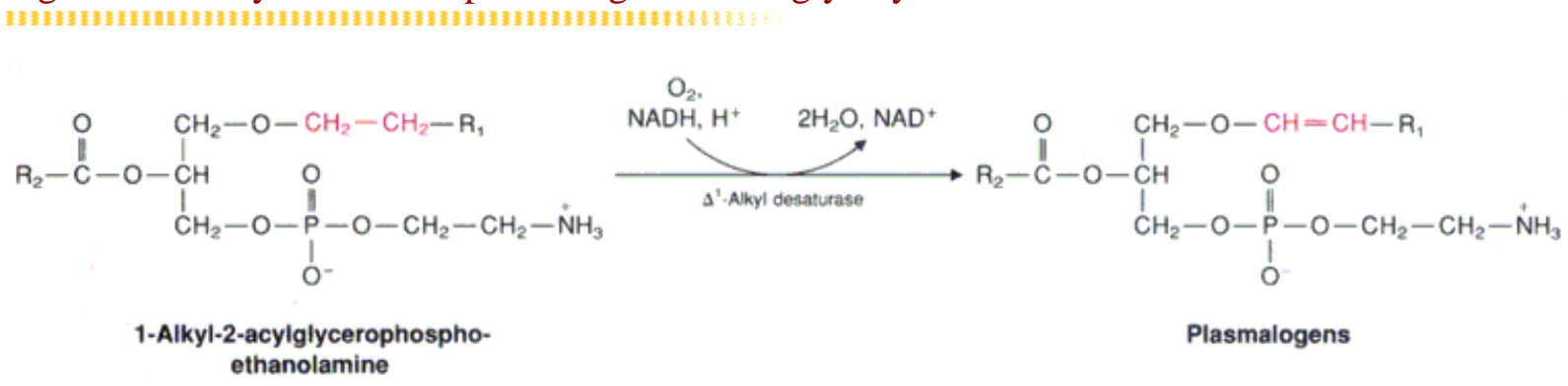

Ether Phospholipids

Ether phospholipids are lipids containing an alkyl group, rather than an acyl group, linked to one of the oxygen atoms of glycerol (see [here](#)). Metabolic pathways leading to **ether phospholipids** are shown in [Figure 19.11](#) and [Figure 19.12](#).

Plasmalogens (vinyl ethers) are phospholipids containing an alkenyl ether at position sn-1 of **glycerol**. They are synthesized in peroxisomes ([Figure 19.12](#)) and constitute 50% of all choline phospholipids in heart tissue. Nevertheless, they are virtually undetectable elsewhere in the body. Individuals deficient in plasmalogen synthesis (such as those with Zellweger syndrome) suffer damage to brain, liver, and kidney before reaching an early death.

Platelet-activating factor ([structure](#)) is a glycerol ether with potent physiological properties. At concentrations as low as 1 picomolar, it stimulates of blood platelet aggregation, reduction of blood pressure, activation of several white blood cell classes, decreased cardiac output, glycogenolysis, uterine contraction.

Ether phospholipids are abundant in halophilic ("salt loving") microorganisms. These are bacteria and protozoa that grow in media with NaCl concentrations as high as 4M. The stability of alkyl ethers against hydrolysis, compared to acyl esters, may be the reason.

See also: [Plasmalogens](#), [Glycerophospholipid Metabolism in Eukaryotes](#)

INTERNET LINKS:

1. [Zellweger Syndrome](#)
 2. [Introduction to the Archaea \(Life in the Extremes\)](#)
-

Unnumbered Item



Platelet activating factor is shown on the right.

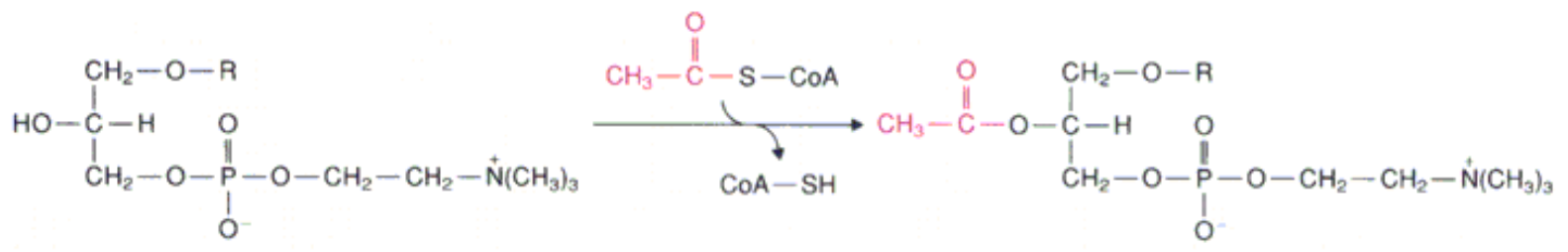

Phosphatidylcholine

Phosphatidylcholine is the donor of the acyl group to **cholesterol** in the **LCAT**-catalyzed esterification of cholesterol.

See also: [Figure 19.2](#),
[Glycerophospholipid Metabolism in Eukaryotes](#)

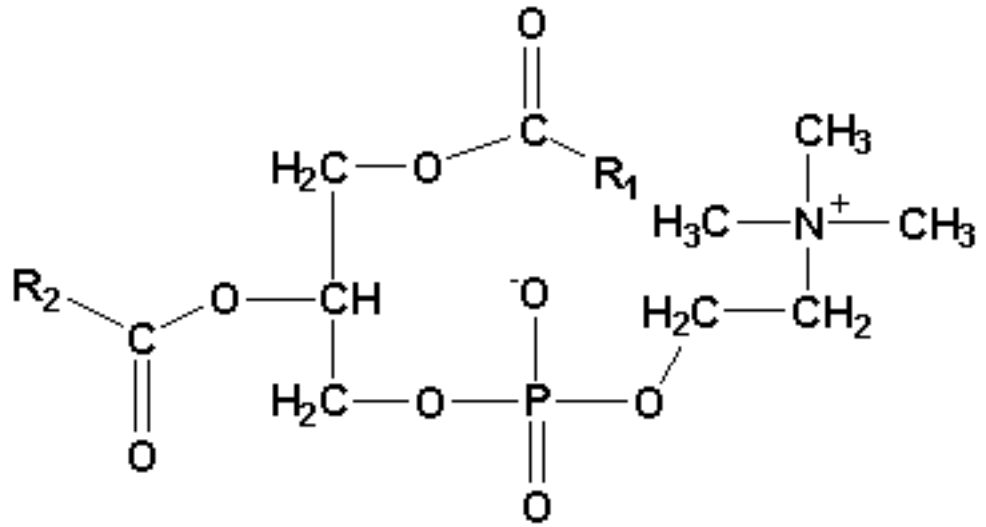

Phosphatidylcholine

Cholesterol

Cholesterol is a member of a large group of substances called **steroids**, which include **vitamin D** and a number of **steroid hormones**, among them the sex hormones of higher animals. In fact, **cholesterol** is the precursor for the synthesis of many of these substances and is also a precursor of the **bile acids**.

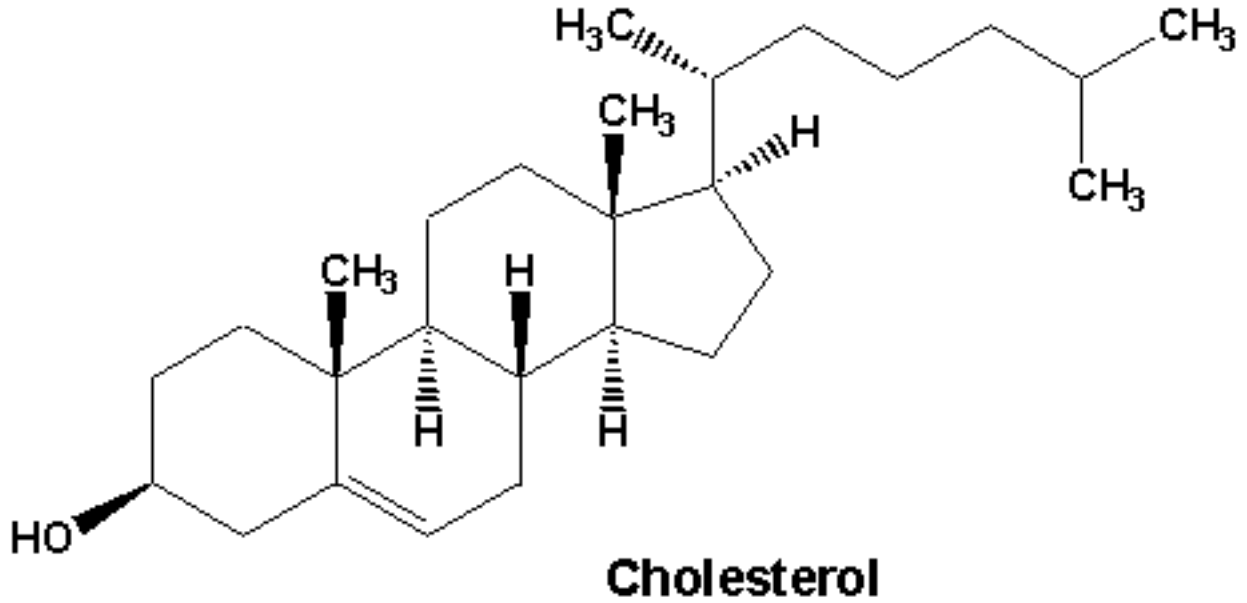

Cholesterol is an important component of animal membranes and affects **membrane fluidity**. A space-filling model can be seen in **Figure 10.9** and numbering of the ring system is shown in **Figure 19.16**. **Cholesterol** can be synthesized exclusively from **acetyl-CoA** (see **here**). An important regulatory enzyme in **cholesterol** biosynthesis is hydroxymethylglutaryl-CoA reductase (**HMG-CoA reductase**), which is allosterically inhibited in the presence of **cholesterol**. (See Cholesterol Biosynthesis)

A primary risk factor predisposing to heart disease is an abnormally elevated level of **cholesterol** in the blood. Prolonged **cholesterol** accumulation contributes to the development of **atherosclerotic** plaques, fatty deposits that line the inner surfaces of coronary arteries. **Cholesterol** is highly insoluble in the aqueous environment of blood, and it accumulates in white blood cells that become deposited at sites of injury or damage on inner arterial walls. If **cholesterol** levels are too high for its subsequent removal into the bloodstream, these cells become engorged with fatty deposits, which then harden into plaque, ultimately blocking key blood vessels and causing myocardial infarctions, or heart attacks.

Cholesterol travels in the bloodstream via lipoprotein complexes called **Chylomicrons**, **VLDL**, **IDL**, **LDL**, and **HDL**. Of the five lipoprotein classes, LDL is by far the richest in **cholesterol**. **Cholesterol** in plasma lipoproteins exists both as the free sterol and esterified at its hydroxyl position with a long-chain **fatty acid**, usually unsaturated (see also **Table 18.1**). The **LDL** particle contains a single molecule of **apoprotein B-100** (Mr = 513,000) as its primary protein component. Because cholesterol biosynthesis is confined primarily to the liver with some occurring also in intestine, LDL plays an important role in delivering **cholesterol** to other tissues. **Cholesterol esters** are too hydrophobic to traverse cell membranes by themselves and must be transported into cells via specialized LDL receptors.

See also: [Steroids, Molecular Structures and Properties of Lipids](#) (from Chapter 10), [Bile Acids, Steroid Hormone Synthesis](#)

INTERNET LINK:

[Lipid Transport](#)

1. [Steroid Hormone Metabolism](#)
 2. [Androgen and Estrogen Metabolism](#)
 3. [Sterol Biosynthesis](#)
 4. [Bile Acid Biosynthesis](#)
-

Steroids

Steroids are a class of molecules derived from [cholesterol](#) ([Figure 10.9](#)). They include the D vitamins and the [steroid hormones](#).

See also: [Lipids](#), [Steroid synthesis](#), [Molecular Structures and Properties of Lipids](#), [Vitamin D](#)

INTERNET LINKS: [Sterol Biosynthesis](#)

Figure 10.9: Cholesterol.

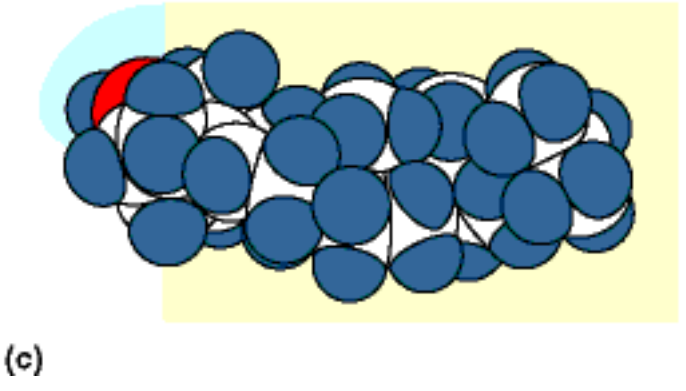
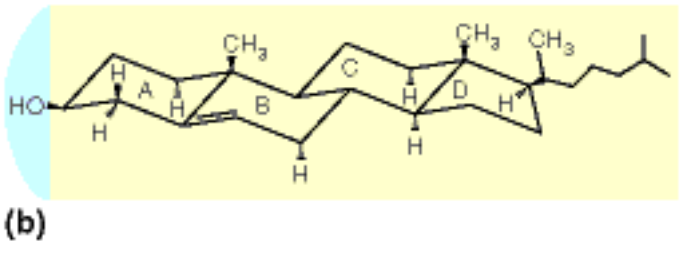
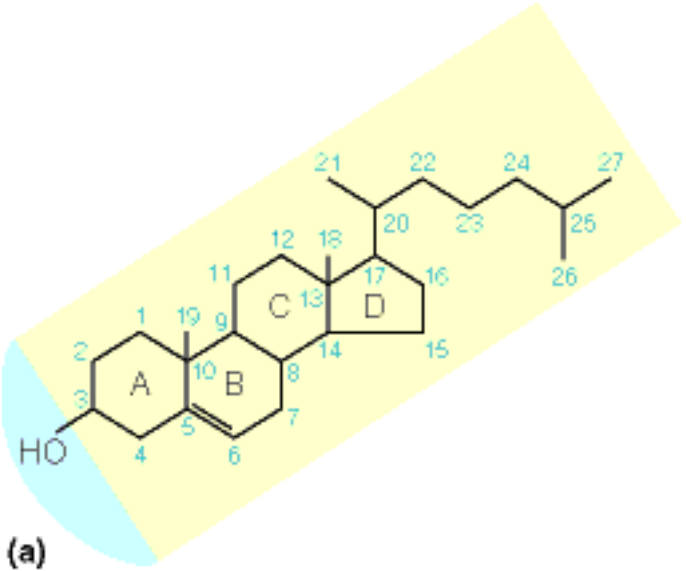

Steroid Hormones

Steroid hormones are hormones that are derived from [cholesterol](#). They are unusual in that they are not stored for release after synthesis. Therefore, the level of a circulating **steroid hormones** is controlled primarily by its rate of synthesis, which is often controlled ultimately by signals from the brain. These signals usually act through intermediary hormones.

The five major classes of **steroid hormones** are the [progestins](#), [mineralocorticoids](#), [glucocorticoids](#), [androgens](#), and [estrogens](#) ([Figure 19.24](#))

See also: [Steroid Hormone Synthesis](#), [Steroid Hormones](#), [Steroid Metabolism](#), [Steroids](#), [Cytochrome P-450](#), [Steroid and Thyroid Hormones - Intracellular Receptors](#)

INTERNET LINKS:

1. [Steroid Hormone Metabolism](#)
 2. [Androgen and Estrogen Metabolism](#)
-

Progestins

Progestins are a class of steroid hormone from which all of the other major classes of steroid hormones are derived ([Figure 19.24](#)). [Progesterone](#) is a **progestin** that is synthesized from [pregnenolone](#).

See also: [Steroid Metabolism](#), [Steroid Hormones](#), [Steroid Hormone Synthesis](#), [Cholesterol Biosynthesis](#), [Cholesterol](#)

INTERNET LINK: [Steroid Hormone Metabolism](#)

Figure 19.24: Biosynthetic routes from pregnenolone to other steroid hormones.

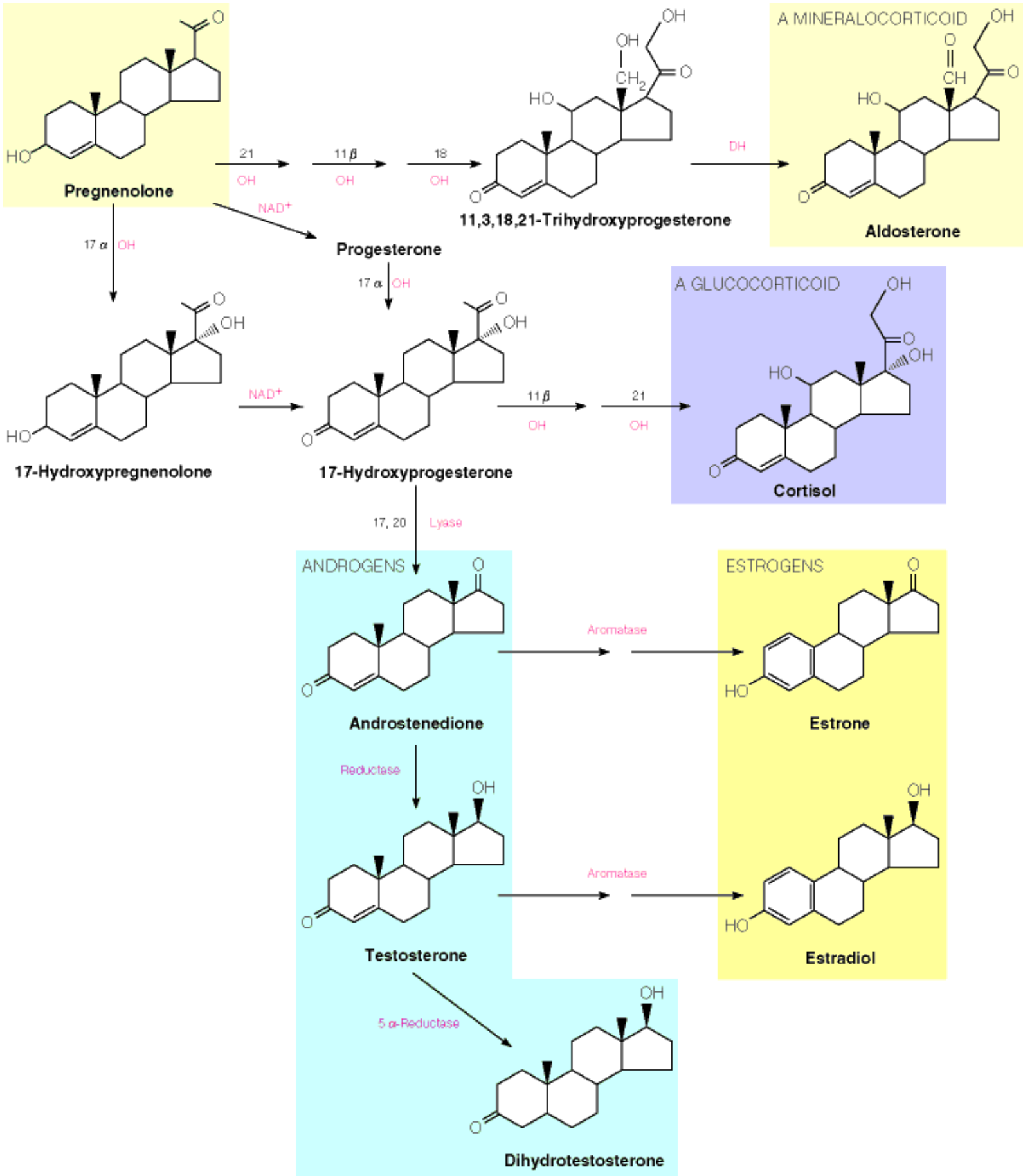

Progesterone

Progesterone is a steroid hormone (classified as a progestin) that is the precursor of all the other major classes of steroid hormone ([Figure 19.24](#)). **Progesterone** is a **progestin** that is synthesized from [pregnenolone](#). (see [here](#)).

See also: [Steroid Metabolism](#), [Steroid Hormones](#), [Steroid Hormone Synthesis](#), [Cholesterol Biosynthesis](#), [Cholesterol](#), [RU486](#), [Steroid and Thyroid Hormones - Intracellular Receptors](#)

INTERNET LINK: [Steroid Hormone Metabolism](#)

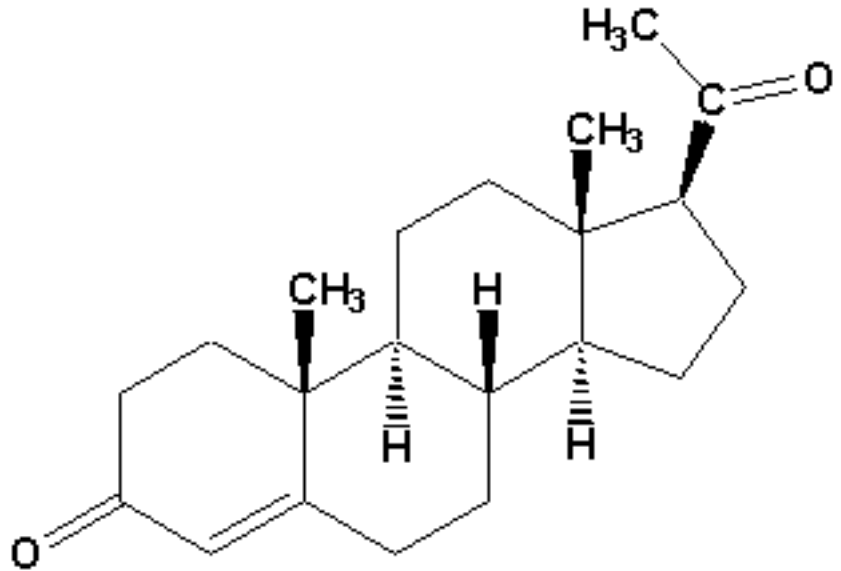

Progesterone

Pregnenolone

Pregnenolone is a steroid hormone that is the precursor of all the other major classes of steroid hormone. **Pregnenolone** is made from **cholesterol** by cleavage of part of the side chain after dual hydroxylation (see [here](#)). Subsequently **pregnenolone** is converted to **progesterone** ([Figure 19.24](#)) by dehydrogenation and double-bond isomerization.

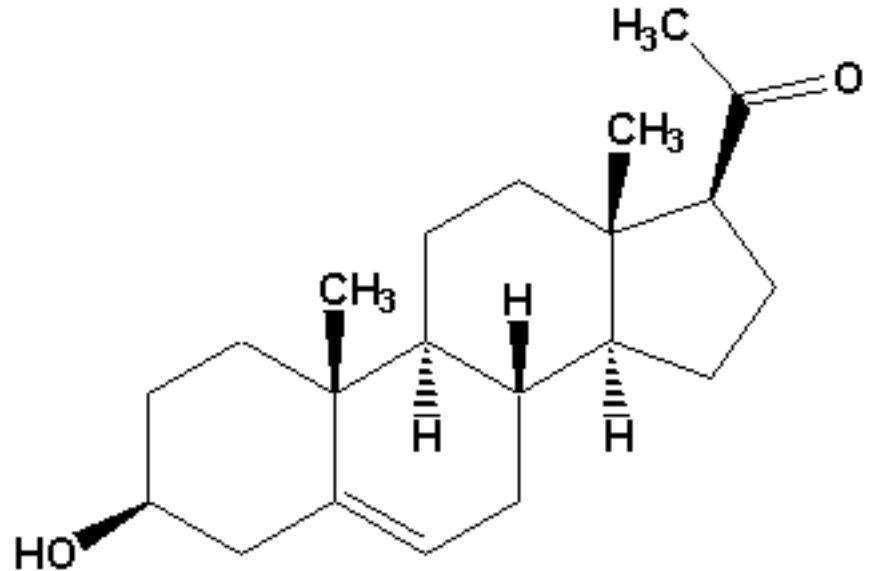

Pregnenolone

See also: [Steroid Metabolism](#), [Steroid Hormones](#), [Steroid Hormone Synthesis](#), [Cholesterol Biosynthesis](#), ,

INTERNET LINK: [Steroid Hormone Metabolism](#)

Unnumbered Item

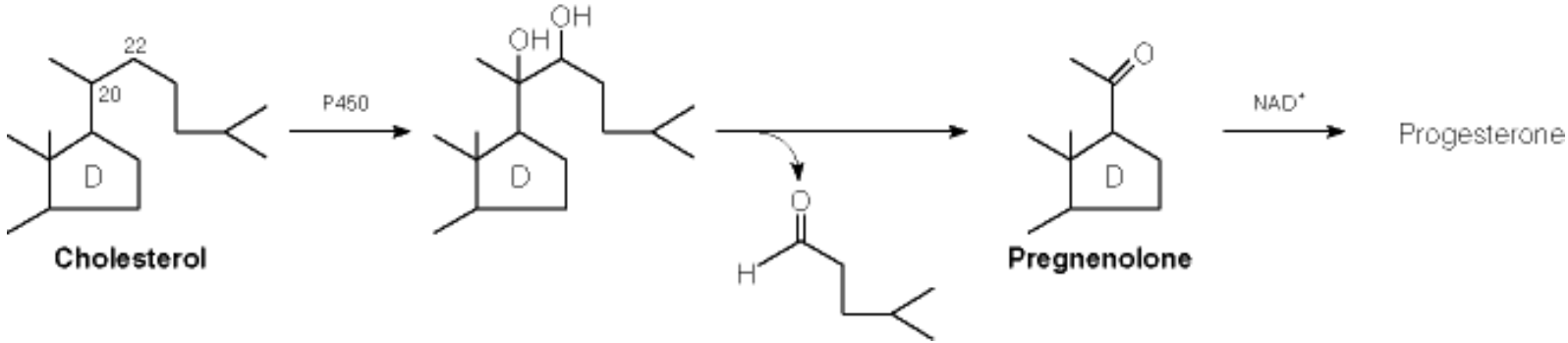

Steroid Metabolism

Steroids are one subclass of a broad group of lipids known as isoprenoids or terpenes. **Steroids** are a group of molecules derived from or having a structural relationship to cholesterol ([Figure 19.17](#)).

All 27 carbons in cholesterol can be traced to a two-carbon precursor - acetate.

Cholesterol biosynthesis springs from a six-carbon intermediate called mevalonate ([Figure 19.18](#)). Mevalonate arises, in turn, from linkage of two [acetyl-CoAs](#) in the mitochondrion to form [acetaoacetyl-CoA](#) (4 carbons), followed by addition of another acetyl group from a third acetyl-CoA to give [3-hydroxy-3-methylglutaryl-CoA](#) (HMG-CoA). This latter compound is reduced by HMG-CoA reductase in the endoplasmic reticulum, using two NADPHs, with coincident loss of CoASH.

[HMG-CoA reductase](#) is the major regulatory enzyme in cholesterol biosynthesis. HMG-CoA reductase is controlled hormonally by [insulin](#) and [glucagon](#) and transcription and translation of the enzyme can be suppressed by the presence of cholesterol in cells.

Classes of molecules made from cholesterol include [bile acids](#) ([Figure 19.23](#)) and [steroid hormones](#) ([Figure 19.24](#)).

See also: [Cholesterol Biosynthesis](#), [Bile Acids](#), [Steroid Hormone Synthesis](#), [HMG-CoA Reductase](#), [HMG-CoA](#), [Cholesterol](#), [Mevalonate](#)

INTERNET LINKS:

1. [Steroid Hormone Metabolism](#)
 2. [Androgen and Estrogen Metabolism](#)
 3. [Sterol Biosynthesis](#)
 4. [Bile Acid Biosynthesis](#)
 5. [Terpenoid Biosynthesis](#)
-

Figure 19.17: Ring identification system (a) and carbon numbering system (b) used for steroids.

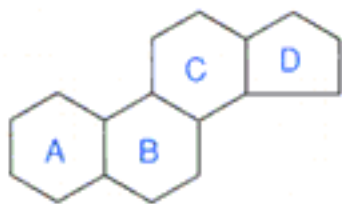

(a) Perhydrocyclopentanophenanthrene

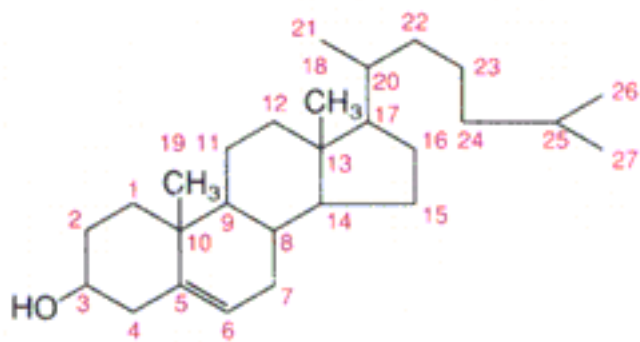

(b) Cholesterol

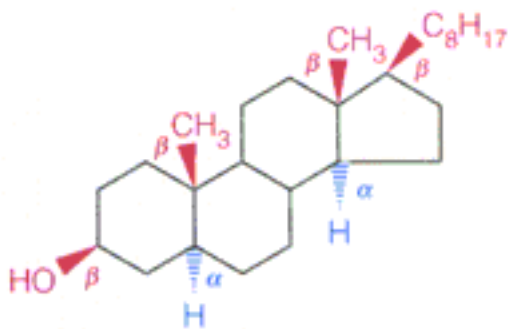

(c) Two-dimensional representation of cholesterol

Figure 19.18: Biosynthesis of mevalonate.

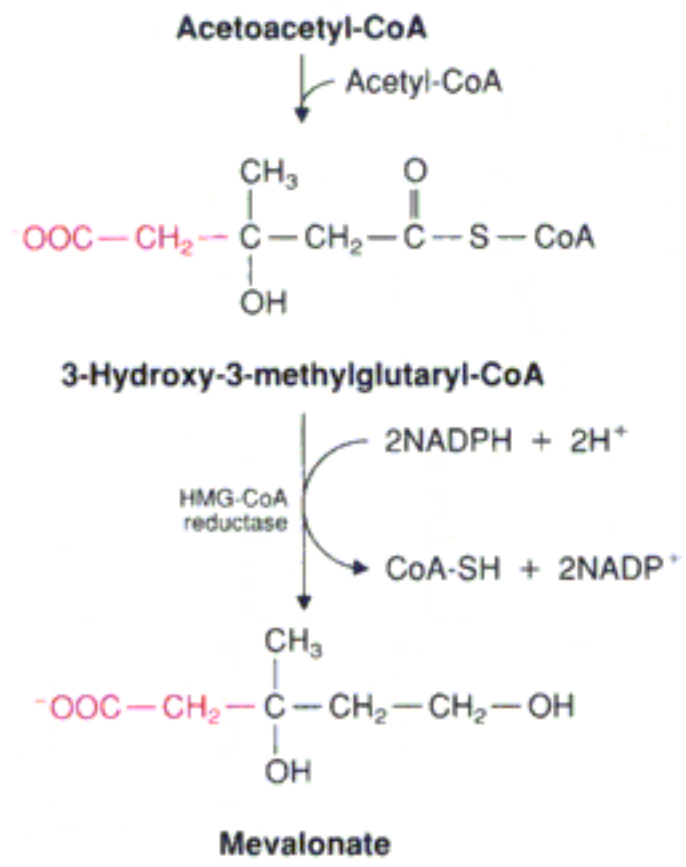

Acetoacetyl-CoA

Acetoacetyl-CoA is an intermediate in fatty acid oxidation, cholesterol biosynthesis and ketone body metabolism (ketogenesis) participating in the following reactions:

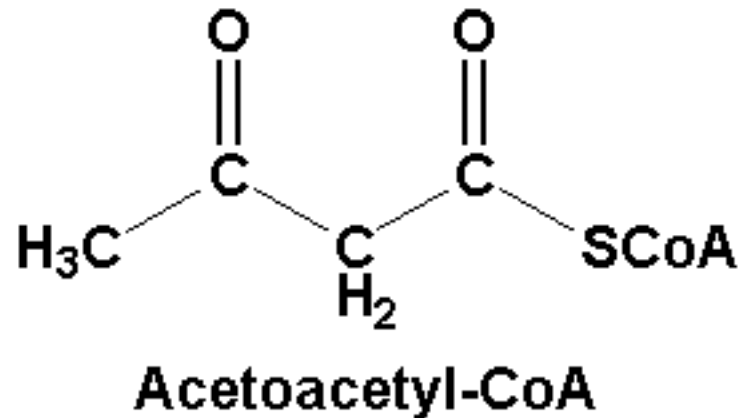

1. 2 [Acetyl-CoA](#) \rightleftharpoons **Acetoacetyl-CoA** + [CoASH](#) (Catalyzed by [Thiolase](#)).
2. **Acetoacetyl-CoA** + [Acetyl-CoA](#) \rightleftharpoons [HMG-CoA](#) + [CoASH](#) (Catalyzed by [HMG-CoA Synthase](#))
3. [Acetoacetate](#) + [Succinyl-CoA](#) \rightleftharpoons **Acetoacetyl-CoA** + [Succinate](#) (Catalyzed by [3-Ketoacyl-CoA Transferase](#)).

Reaction #1 is a reversal of the last step of fatty acid oxidation.

See also: [Fatty Acid Oxidation](#), [Biosynthesis of Cholesterol](#) (from Chapter 19), [Ketogenesis](#), [Figure 18.21](#)

β -Ketoacyl-ACP Synthase

β -Ketoacyl-ACP synthase catalyzes addition of acetyl group from malonyl-ACP to growing fatty acid chain in fatty acid biosynthesis (Figure 18.27). The reaction is as follows:

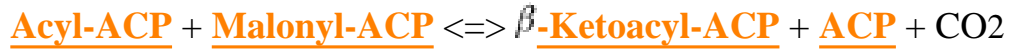

See also: Fatty Acid Biosynthesis Strategy, Fatty Acid Synthase, Fatty Acids, Palmitate Synthesis from Acetyl-CoA, Synthesis of Long Chain Fatty Acids

INTERNET LINK: Fatty Acid Biosynthesis

Acyl-ACP

Acyl-ACP is an intermediate in fatty acid synthesis. Reactions involving **Acyl-ACP** in fatty acid biosynthesis are shown as follows ([Figure 18.27](#)):

1. Trans- Δ^2 -Enoyl-ACP + NADPH + H⁺ \rightleftharpoons **Acyl-ACP** + NADP⁺ (catalyzed by Enoyl-ACP Reductase)

2. **Acyl-ACP** + Malonyl-ACP \rightleftharpoons β -Ketoacyl-ACP + ACP, + CO₂ (catalyzed by β -Ketoacyl-ACP Synthase)

See also: [Fatty Acid Biosynthesis Strategy](#), [Fatty Acid Synthase](#), [Fatty Acids](#), [Palmitate Synthesis from Acetyl-CoA](#), [Synthesis of Long Chain Fatty Acids](#)

INTERNET LINK: [Fatty Acid Biosynthesis](#)

Enoyl-ACP Reductase



Enoyl-ACP reductase catalyzes the final reduction in the process of fatty acid biosynthesis.



See also: [Fatty Acid Biosynthesis Strategy](#), [Fatty Acid Synthase](#), [Fatty Acids](#), [Palmitate Synthesis from Acetyl-CoA](#), [Synthesis of Long Chain Fatty Acids](#), [Figure 18.27](#)

Chain Elongation of Palmitate

Elongation of the acyl group to make fatty acids longer than 16 carbons ([palmitate](#)) occurs apart from palmitate synthesis. Whereas palmitate synthesis occurs in the cytosol, **elongation** occurs in both the mitochondria and endoplasmic reticulum (ER). The ER is the dominant system. **Elongation** in the ER differs from cytosolic synthesis in employing coenzyme A (instead of acyl carrier protein) and separate enzymes (instead of a complex). The condensation reaction occurs between malonyl-CoA and an acyl-CoA to form a β -ketoacyl-CoA (see [here](#) and [here](#)). Two enzymes catalyze this step in the endoplasmic reticulum, one of which is specific for unsaturated fatty acyl-CoAs.

See also: [Fatty Acid Biosynthesis Strategy](#), [Palmitate Synthesis from Acetyl-CoA](#)

INTERNET LINK: [Fatty Acid Metabolism](#)

Unnumbered Item

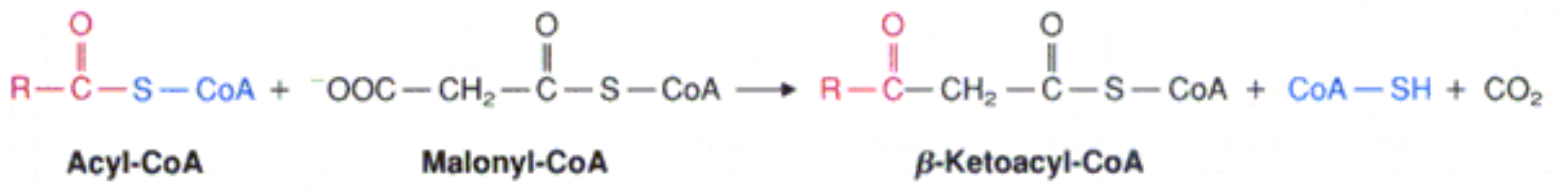

Unnumbered Item

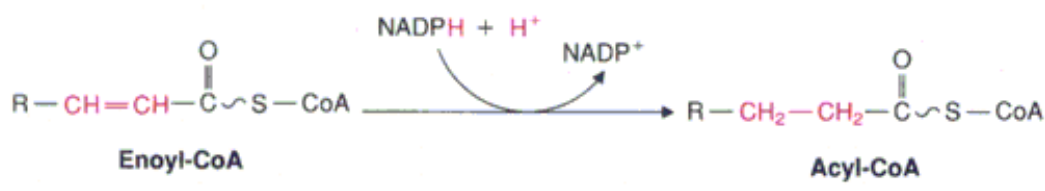
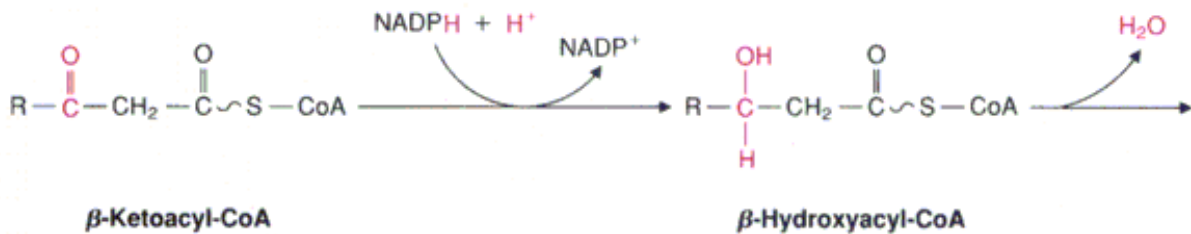

β -Ketoacyl-ACP Reductase

β -Ketoacyl-ACP reductase catalyzes the reduction of β -ketoacyl-ACP to D-3-hydroxyacyl-ACP in fatty acid biosynthesis ([Figure 18.27](#)). The reaction is as follows:

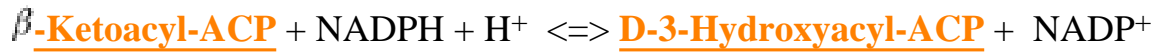

See also: [Fatty Acid Biosynthesis Strategy](#), [Fatty Acid Synthase](#), [Fatty Acids](#), [Palmitate Synthesis from Acetyl-CoA](#), [Synthesis of Long Chain Fatty Acids](#)

INTERNET LINK: [Fatty Acid Biosynthesis](#)

3-Hydroxyacyl-ACP Dehydrogenase

3-hydroxyacyl-ACP dehydrase is part of the fatty acid synthase complex. It catalyzes the reaction that follows in fatty acid biosynthesis ([Figure 18.27](#)):



See also: [Fatty Acid Biosynthesis Strategy](#), [Fatty Acid Synthase](#), [Fatty Acids](#), [Palmitate Synthesis from Acetyl-CoA](#), [Synthesis of Long Chain Fatty Acids](#)

INTERNET LINK: [Fatty Acid Biosynthesis](#)

Enoyl-CoA Hydratase

Enoyl-CoA hydratase catalyzes addition of water to trans- Δ^2 -enoyl-S-CoA in the process of fatty acid oxidation ([Figure 18.16](#)). The product of this reaction is the stereospecific L isomer of 3-hydroxyacyl-CoA.

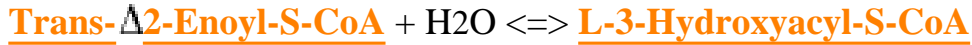

See also: [\$\beta\$ -Oxidation of Saturated Fatty Acid](#), [Unsaturated Fatty Acid Oxidation](#), [Oxidation of Odd-Numbered Fatty Acids](#), [Peroxisomal \$\beta\$ -Oxidation](#), [Fatty Acids](#), [Figure 18.16](#)

INTERNET LINK: [Fatty Acid Metabolism](#)

Oxidation of Unsaturated Fatty Acids

Enoyl-CoA Hydratase, a key enzyme in β -oxidation of saturated fatty acids, acts on *trans* double bonds, but cannot act on the *cis* double bonds of **unsaturated fatty acids**. Instead, cells must rely on two additional enzymes, enoyl-CoA isomerase and 2,4-dienoyl-CoA reductase, to complete the β -oxidation of **unsaturated fatty acids**. The activity of these enzymes is shown in **Figure 18.18**.

1. **Enoyl-CoA Isomerase** catalyzes conversion of *cis* double bonds at positions 3-4 to *trans* double bonds at positions 2-3.
2. **2,4-Dienoyl-CoA Reductase** catalyzes the reduction of the conjugated double bonds, *cis* 4-5 and *trans* 2-3 to a single *cis* double bond between carbons 3-4. This reaction uses electrons from NADPH.

In each case, enoyl-CoA isomerase and 2,4-dienoyl-CoA reductase converts an intermediate with a *cis* double bond into an intermediate with a *trans* double bond. Moreover, the *trans* double bond has the appropriate structure to be handled by the enzymes involved in the β -oxidation of saturated fatty acids.

It should be noted that enoyl-CoA isomerase and 2,4-dienoyl-CoA reductase only help metabolize dietary **unsaturated fatty acids** with double bonds in the *cis* configuration. Dietary fatty acids with *trans* double bonds are not readily metabolized and may pose a health hazard.

See also: **β -Oxidation of Saturated Fatty Acids**

INTERNET LINK: [Position Paper on Trans Fatty Acids](#)

Figure 18.18: β -Oxidation pathway for polyunsaturated fatty acids.

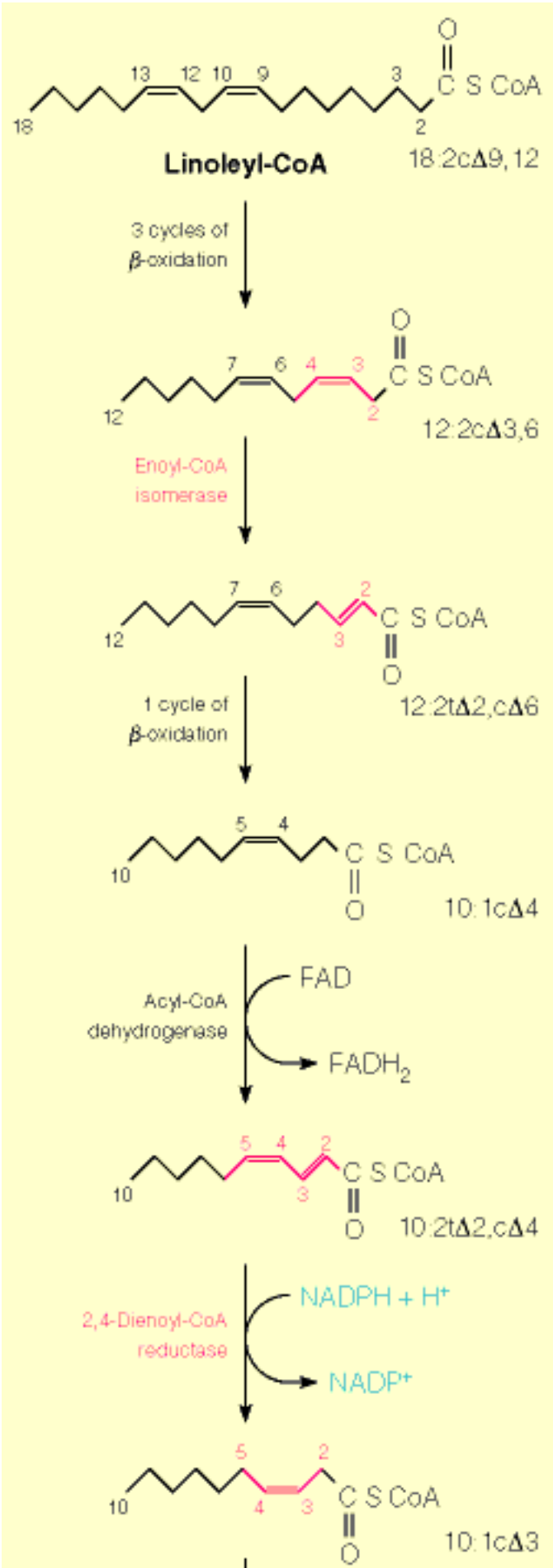

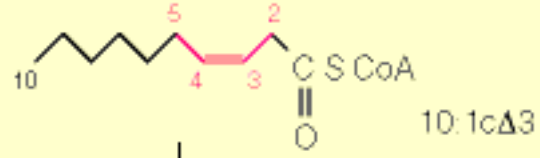

Enoyl-CoA
isomerase

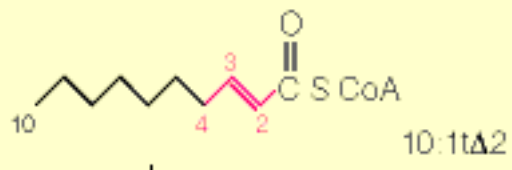

4 cycles of
 β -oxidation



Acetyl-CoA

Enoyl-CoA Isomerase

Enoyl-CoA isomerase catalyzes conversion of *cis*-double bonds at position 3-4 to *trans* double bonds at position 2-3. This is shown as the second reaction in [Figure 18.18](#).

Together with [2,4-dienoyl-CoA reductase](#), **enoyl-CoA isomerase** allows cells to oxidize unsaturated fatty acids containing *cis* double bonds via β oxidation.

See also: [Oxidation of unsaturated fatty acids](#), [\$\beta\$ oxidation](#)

2,4-Dienoyl-CoA Reductase

2,4-dienoyl-CoA reductase is an enzyme essential for β oxidation of unsaturated fatty acids. It catalyzes the formation of cis- Δ^3 -enoyl-CoA from trans- Δ^2 -cis- Δ^4 -enoyl-CoA (Reaction #5, [Figure 18.18](#)).

Along with the enzyme [enoyl-CoA isomerase](#), **2,4-dienoyl-CoA reductase** permits unsaturated fatty acids in the diet containing *cis* double bonds to be catabolized.

See also: [Enoyl-CoA Isomerase](#), [Oxidation of Unsaturated Fatty Acids](#), [\$\beta\$ Oxidation of Fatty Acids](#)

Peroxisomal β Oxidation of Fatty Acids

A modified form of β -oxidation of fatty acids occurs in **peroxisomes**, organelles that are present in most eukaryotic cells. Here electrons are passed to an enzyme-bound form of FAD, but electrons from FADH₂ are passed directly to oxygen, forming hydrogen peroxide

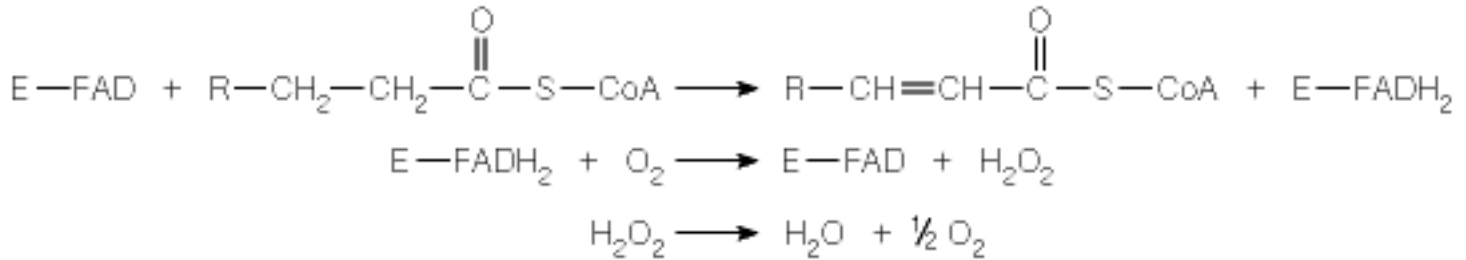

No ATPs are generated as a result of this electron transfer, but heat is generated. **Peroxisomal β -oxidation** also only proceeds as far as C₄ and C₆ acyl-CoAs. However, the C₄ and C₆ acyl groups can be transferred to **carnitine** for transport into **mitochondria** (**Figure 18.15**), where oxidation can be completed. The function of the **peroxisomal pathway** is not yet clear, but it probably involves the initial stages in oxidizing very long-chain fatty acids and other lipids.

See also: [**\$\beta\$ Oxidation of Saturated Fatty Acids**](#)

Carnitine

Carnitine is linked to acyl groups transported into the mitochondria for oxidation ([Figure 18.15](#)). Acyl-CoAs in the cytoplasm are converted to acyl-carnitine derivatives by action of **carnitine** acyltransferase I on the outer portion of the mitochondrial inner membrane. A translocase carries the acyl-**carnitine** into the mitochondria. Once inside the mitochondrial matrix, **carnitine** is replaced on the acyl group by CoASH. The acyl-CoA then is free to go through β oxidation or elongation.

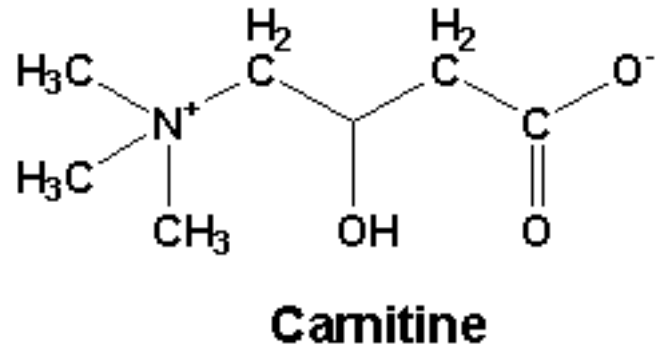

See also: [Fatty Acids](#), [Carnitine Acyltransferase I](#), [Carnitine Acyltransferase II](#), [Acyl-CoAs](#), [Acyl-Carnitine](#), [CoASH](#), [S-Adenosylmethionine and Biological Methylation](#)

Figure 18.15: The carnitine cycle, for transport of fatty acyl-CoAs into mitochondria.

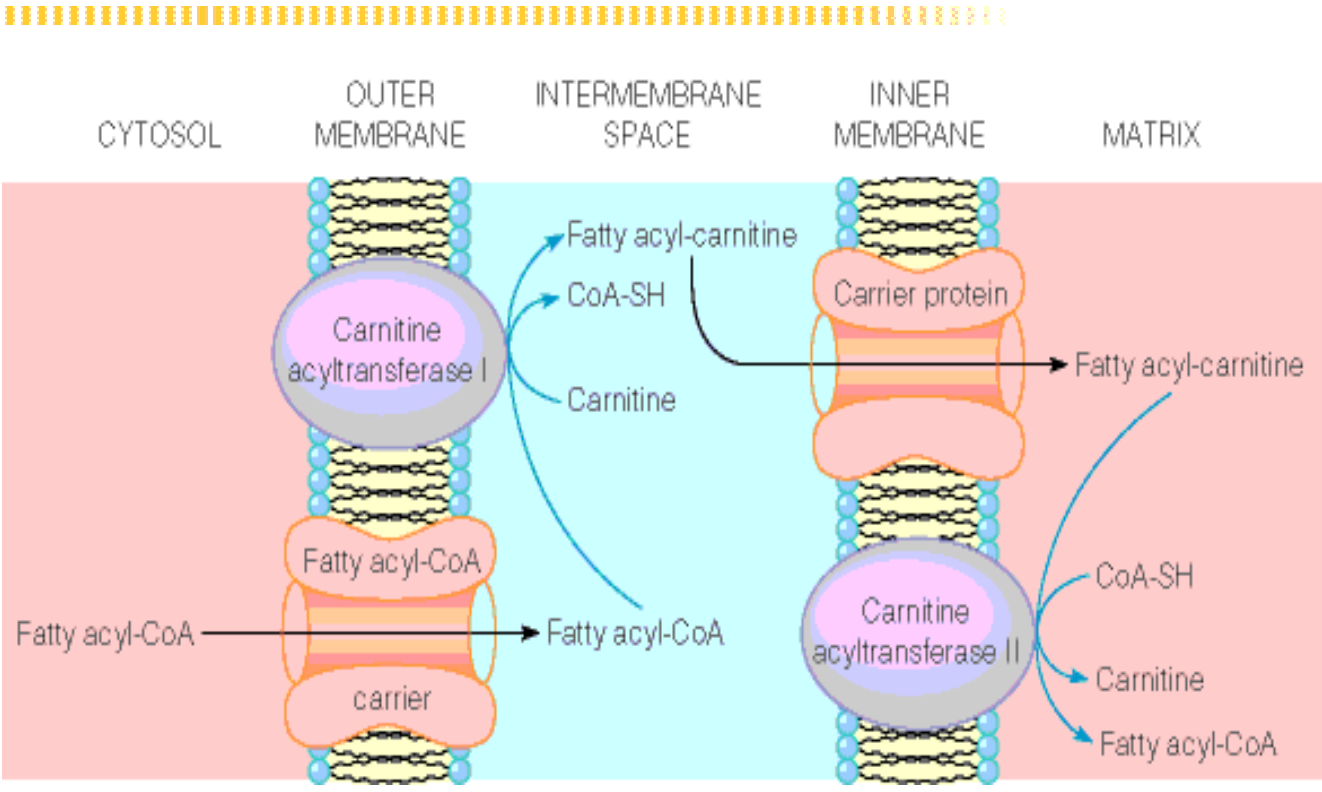

Carnitine Acyltransferase I (Acyltransferase I)

Carnitine acyltransferase I is an enzyme outside the mitochondrion that transfers the acyl group on coenzyme A to carnitine in the reaction below. This is the reversal of the reaction catalyzed by Carnitine acyltransferase II inside of the mitochondrion and is essential for transport of the acyl group into the mitochondrion.

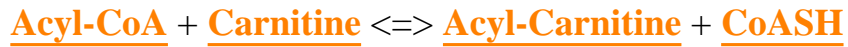

See also: [Carnitine Acyltransferase II](#), [Figure 18.15](#)

Acyl-Carnitine

Acyl-carnitine is the form of transport a fatty acid takes in traversing the mitochondrial inner membrane. Acyl-CoAs in the cytoplasm are converted to **acyl-carnitine** derivatives by action of carnitine acyltransferase I on the outer portion of the mitochondrial inner membrane ([Figure 18.15](#)).

A translocase carries the **acyl-carnitine** into the mitochondria. Once inside the mitochondrial matrix, carnitine is replaced on the acyl group by CoASH in a reaction catalyzed by carnitine acyltransferase II.

See also: [Carnitine Acyltransferase I](#), [Carnitine Acyltransferase II](#), [Carnitine](#), [Fatty Acid](#), [Acyl-CoAs](#), [CoASH](#)

Carnitine-Acyltransferase II (Acyltransferase II)

Carnitine acyltransferase II is an enzyme in the mitochondrial matrix that transfers the incoming acyl group on carnitine to coenzyme A in the reaction below. The reaction is the reversal of the reaction catalyzed by carnitine acyltransferase I outside of the mitochondrion.



See also: [Carnitine Acyltransferase I](#), [Figure 18.15](#)

S-Adenosylmethionine and Biological Methylation

S-Adenosylmethionine (AdoMet) is a metabolically activated form of **methionine** capable of donating a methyl group. **AdoMet** is formed in the reaction shown [here](#). Transfer of a methyl group from **AdoMet** to a target molecule converts **AdoMet** to **S-Adenosylhomocysteine (AdoHcy)** (see [here](#)). **Table 21.1** lists some important **AdoMet**-dependent transmethylation. Substrates range from small metabolites, such as **norepinephrine**, to polymers, such as DNA (see [here](#)), RNA, or proteins.

In proteins, targets for methylation include **lysine**, **arginine**, and residues containing free carboxyl groups. **Histones** (chromatin proteins), for example, become methylated at specific arginine and lysine residues at particular times in the cell cycle (see [here](#)). ϵ -N-Trimethyllysine, which is derived specifically from the hydrolysis of methylated proteins, is a precursor of **carnitine**, which transports fatty acyl moieties across membranes (see [here](#)).

Protein methylation plays a role in **chemotaxis** - the process whereby bacteria sense a chemical concentration gradient in the medium and move either toward or away from it. Methylation may protect proteins by

1. Blocking sites of ubiquitination (ubiquitination is a signal for protein turnover - see [here](#)), and
2. Repairing **aspartate** residues modified by environmental damage.

Except for a few reactions in bacteria, the only known methyl group transfer in cells that does not involve **AdoMet** is the synthesis of **methionine** itself. This can happen in two ways:

1. Through the reduction of **5,10-methylenetetrahydrofolate** to **5-methyltetrahydrofolate**. The methyl group is then transferred to yield **methionine** via methyl-**B12** and methionine synthase ([Figure 20.17](#)).
2. Through the oxidation of **choline**, to yield **glycine betaine**, followed by the transmethylation of **homocysteine** shown [here](#).

AdoMet is also a precursor to the plant hormone, **ethylene**. A similar mechanism is probably involved in making rare fatty acids containing a cyclopropane ring.

See also: [Metabolism of Sulfur-Containing Amino Acids](#), [Ubiquitin](#), [Programmed Destruction of](#)

Unnumbered Item

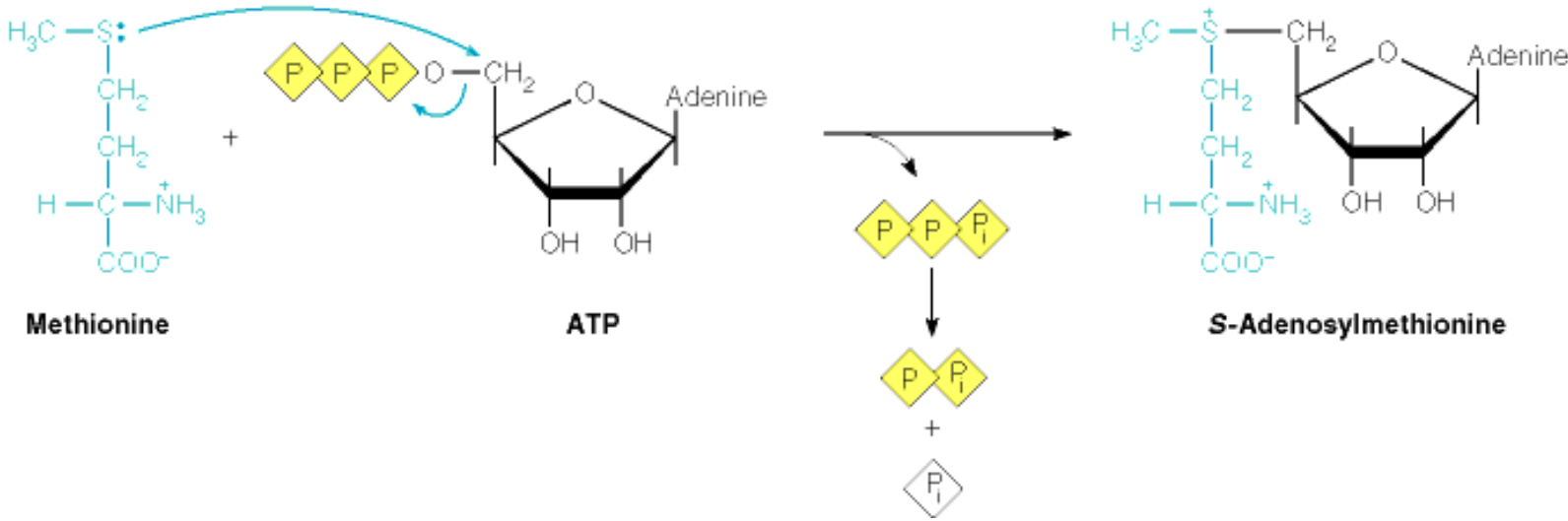

Unnumbered Item

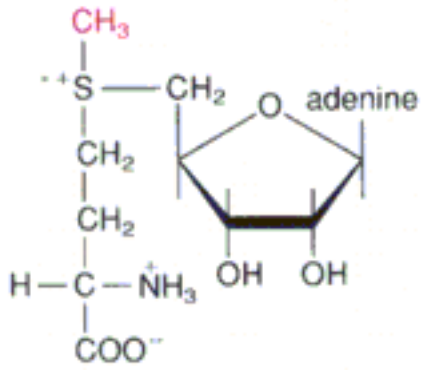

S-Adenosylmethionine (AdoMet)

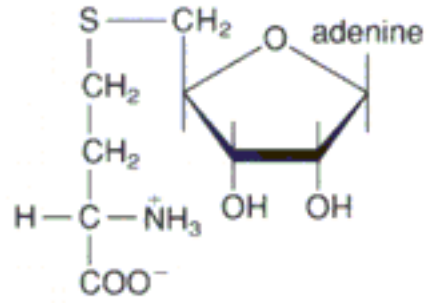

S-Adenosylhomocysteine (AdoHcy)

Table 21.1



Methyl Group Acceptor	Methylated Product
Norepinephrine	Epinephrine
Guanidinoacetic acid	Creatine
Phosphatidylethanolamine	Phosphatidylcholine
DNA-adenine or -cytosine	DNA-N-methyladenine or 5-methylcytosine
tRNA bases	Methylated tRNA bases
Nicotinamide	N ¹ -Methylnicotinamide
Protein amino acid residues	Methylated amino acid residues

Norepinephrine

Norepinephrine is a [catecholamine](#) derived from [dopamine](#) that is a precursor to [epinephrine](#).

Methylation by [S-adenosylmethionine](#) converts **norepinephrine** into epinephrine. The biosynthetic pathway from tyrosine to dopamine, and the other catecholamines is shown in [Figure 21.32](#).

See also: [Neurotransmitters and Biological Regulators](#), [Biochemistry of Neurotransmission](#)
[Tyrosine](#)

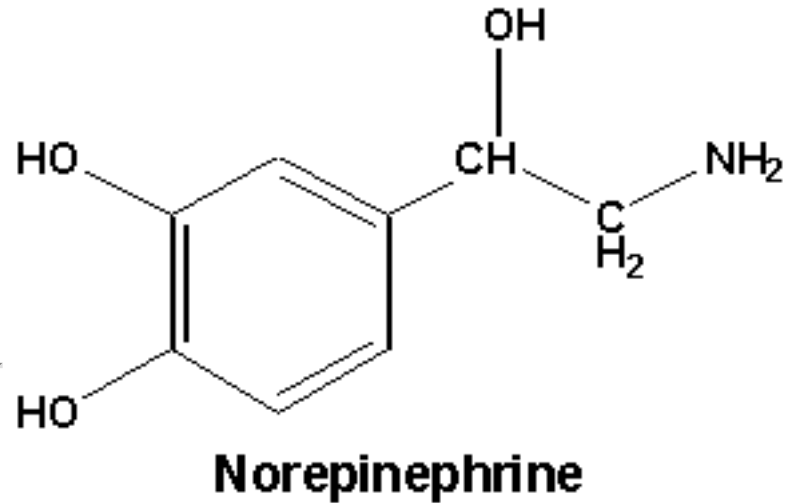

Catecholamines

The term **catecholamine** comes from the aromatic dialcohol, catechol. The most common **catecholamines** are [epinephrine](#), [norepinephrine](#), [dopamine](#), and dihydroxyphenylalanine (**L-Dopa**).

Catecholamine analogs, such as mescaline and amphetamine have potent psychopharmacological properties.

[Figure 21.32](#) depicts the pathway to **catecholamines** from [tyrosine](#).

See also: [Aromatic Amino Acid Utilization](#), [Neurotransmitters and Biological Regulators](#), [Biochemistry of Neurotransmission](#), [Neurotransmitters and Receptors](#), [Action of Epinephrine](#)

INTERNET LINKS:

1. [Catecholamine Disorders](#)
 2. [Dopamine](#)
-

Dopamine

The importance of **dopamine** in neural transmission is emphasized by the number of major neurological diseases that are associated with improper **dopamine** regulation. The earliest indication of this type of defect was the finding that **dopamine** levels are abnormally low in a particular region of the brain of patients with Parkinsonism, a severe neurological disorder. Attempts to treat such patients with dopamine were futile, because after injection, **dopamine** does not cross the bloodbrain barrier. However, the **dopamine** precursor, dopa, does cross the bloodbrain barrier. For many individuals with Parkinsonism, daily doses of dopa have provided dramatic clinical improvement.

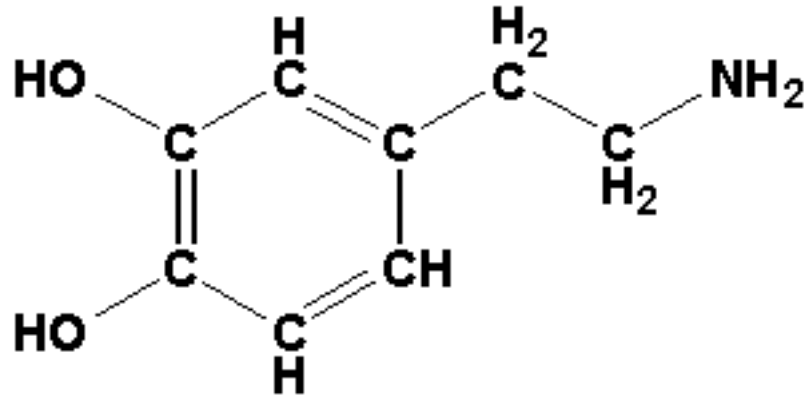

Dopamine

Dopamine is a [catecholamine](#) derived from tyrosine. Other catecholamines include [epinephrine](#) and [norepinephrine](#). The biosynthetic pathway from tyrosine to **dopamine**, and the other catecholamines is shown in [Figure 21.32](#).

See also: [Neurotransmitters and Biological Regulators](#), [Biochemistry of Neurotransmission](#), [Dopa](#)

INTERNET LINK: [Dopamine](#)

Figure 21.32: Biosynthesis of the catecholamines-dopamine, norepinephrine, and epinephrine-from tyrosine.

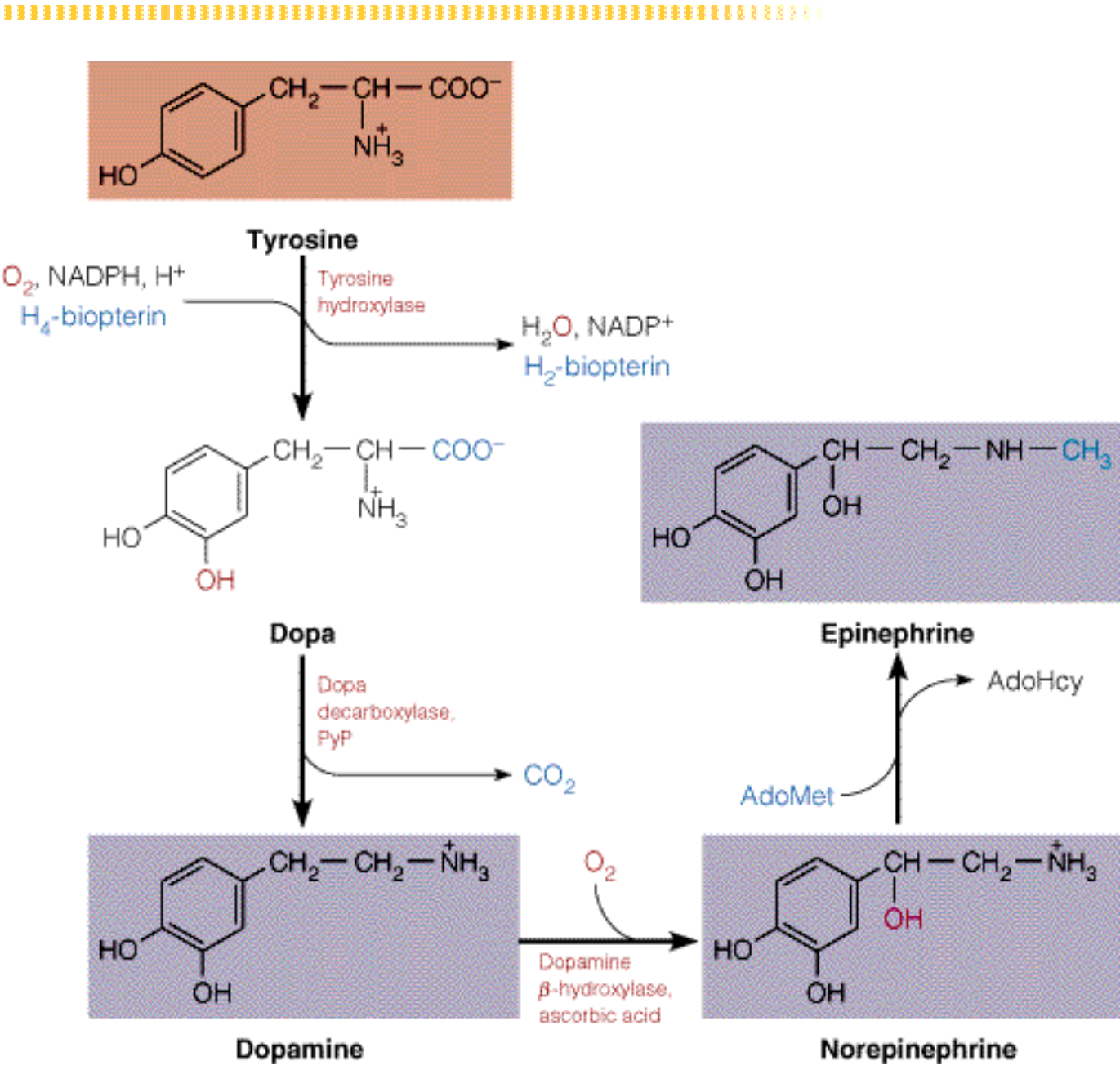

Neurotransmitters and Biological Regulators

Amino acids and their metabolites participate in signal transduction process - hormonal control and the synaptic transmission of nerve impulses. Some compounds, like [epinephrine](#) and histamine (see [here](#)) participate in both processes.

[Glycine](#) and [glutamate](#) are amino acids that serve directly as neurotransmitters are. γ -Aminobutyric acid ([GABA](#)), the decarboxylation product of glutamate, is also a neurotransmitter. Amino acid metabolites that function in neurotransmission include histamine (from [histidine](#)), serotonin (from [tryptophan](#)), and catecholamines ([epinephrine](#), [dopamine](#), and [norepinephrine](#)), which are derived from tyrosine.

[Serotonin](#) - The metabolic biosynthetic pathway from tryptophan to **serotonin** is shown [here](#). **Serotonin** plays multiple roles in the nervous system, including neurotransmission. It is a precursor to [melatonin](#), which is involved in the regulation of sleepiness and wakefulness. In the intestine, **serotonin** regulates intestinal peristalsis. **Serotonin** is also a potent vasoconstrictor, which helps regulate blood pressure.

[Catecholamines](#) - [Figure 21.32](#) depicts the pathway to **catecholamines** from [tyrosine](#).

See also: [Metabolism of Aromatic Amino Acids and Histidine](#), [Neurotransmitters and Receptors](#), [Biochemistry of Neurotransmission](#)

INTERNET LINKS:

1. [Neurotransmitter Receptors and Their Effects](#)
 2. [Neurotransmitter Newsletter](#)
-

Unnumbered Item

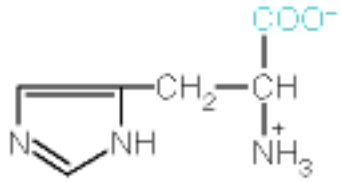

Histidine

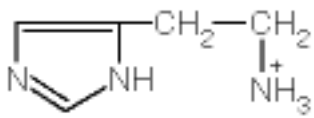
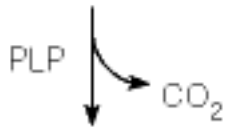

Histamine

γ -Aminobutyric Acid (GABA)

GABA is an amino acid found in brain and other animal tissues that functions as a neurotransmitter.

See also: [Amino Acids Not In Proteins, Neurotransmitters and Biological Regulators](#)

INTERNET LINK: [Neurotransmitter Receptors and Their Effects](#)

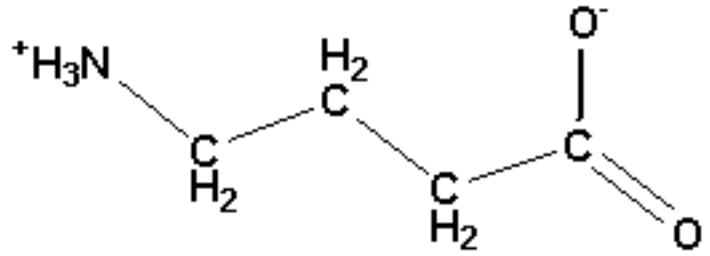

Gamma-aminobutyric acid

β -Cyanoalanine

β -Cyanoalanine is an unusual amino acid derived from [cysteine](#) that is produced in the seeds of *Lathyrus odoratus*. Animals consuming these seeds develop defects in their collagen. In humans the disease is associated with consumption of β -cyanoalanine is called Ehlers-Danlos syndrome and it manifests itself as curvature of the spine and heart problems.

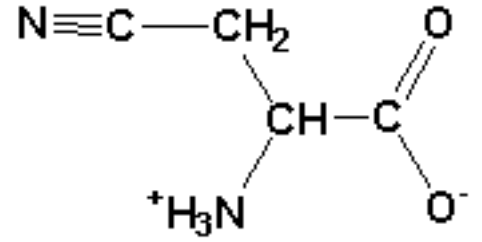

Beta-cyanoalanine

See also: [Amino Acids Not in Proteins](#)

INTERNET LINK: [Ehlers-Danlos Syndrome](#)

β -Alanine

β -Alanine is found in the vitamin [pantothenic acid](#), [coenzyme A](#), and in some important natural peptides. It is the only naturally occurring β amino acid. β -alanine is formed as an end product of [pyrimidine](#) nucleotide catabolism by hydrolysis of β -ureidopropionic acid in the reaction below:

β -[Ureidopropionic acid](#) + H₂O \rightleftharpoons β -Alanine + NH₄⁺ + CO₂ (catalyzed by β -ureidopropionase)

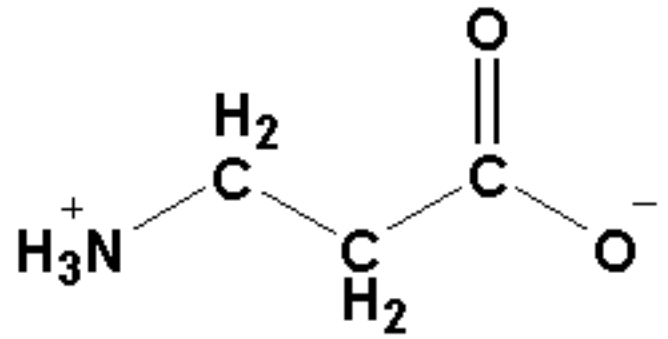

Beta-alanine

See also: [Figure 22.11](#), [Coenzyme A](#), [Amino Acids Not In Proteins](#), [Pyrimidine Catabolism](#)

INTERNET LINKS: [\$\beta\$ -Alanine Metabolism](#)

β -Ureidopropionic Acid

β -Ureidopropionic acid is an intermediate in pyrimidine nucleotide catabolism. Nucleoside phosphorylases act, as shown [here](#) to yield a base and [ribose-1-phosphate](#). If bases or nucleosides are not reused for nucleic acid synthesis via salvage pathways, the bases are further degraded to [uric acid](#) (purines) or β -ureidopropionate (pyrimidines).

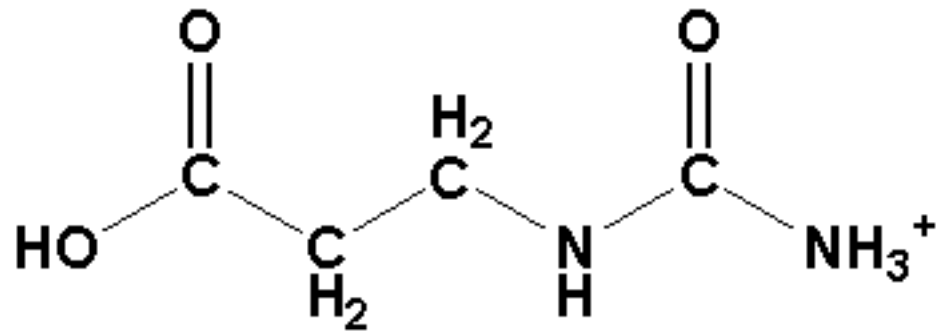

Beta-Ureidopropionic acid

1. [Dihydrouracil](#) + H₂O \rightleftharpoons β -Ureidopropionic Acid (catalyzed by [Hydropyrimidine Hydratase](#))
2. β -Ureidopropionic Acid + H₂O \rightleftharpoons β [Alanine](#) + NH₄⁺ + CO₂ (catalyzed by β -[Ureidopropionase](#))

See also: [Figure 22.11, Pyrimidine Catabolism](#)

INTERNET LINK: [Pyrimidine Metabolism](#)

Unnumbered Item

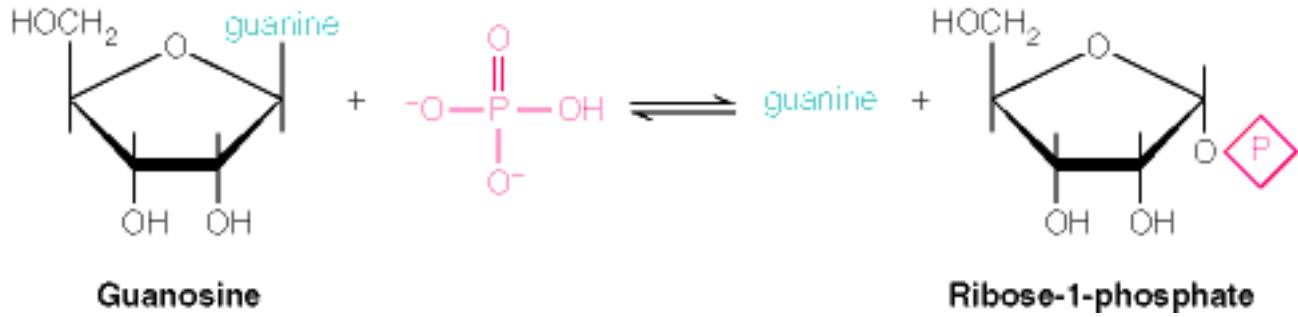

D-Ribose-1-Phosphate

Ribose-1-phosphate is a product of catabolism of nucleosides by phosphorylases ([Figure 22.2](#)). An example reaction is shown [here](#) and as follows:



See also: [Purine Degradation](#), [Pyrimidine Catabolism](#), [Nucleotide Salvage Synthesis](#)

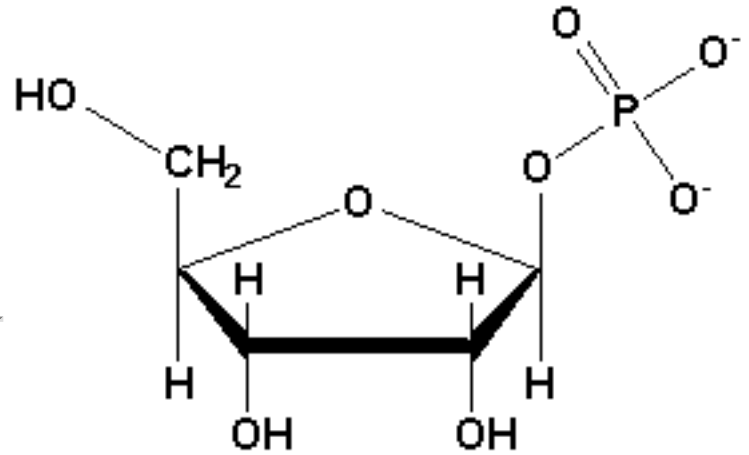

D-Ribose-1-phosphate

Xanthine Oxidase

Xanthine oxidase is a molybdenum-containing enzyme that catalyzes the reaction that follows:

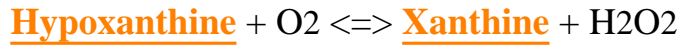

Xanthine oxidase can oxidize xanthine further to **uric acid**, as well ([Figure 22.7](#))

Xanthine oxidase is a target of anti-gout drugs. **Allopurinol**, which is similar to hypoxanthine (see [here](#)), is used to treat gout because it inhibits **xanthine oxidase**, leading to accumulation of **hypoxanthine** and **xanthine**, both of which are more soluble and more readily excreted than **uric acid** (the causative agent of gout).

See also: [Purine Degradation](#), [Excessive Uric Acid in Purine Degradation](#), [Reactive Oxygen](#)

Xanthine

Xanthine is a product of purine catabolism. It is produced as a result of deamination of guanine ([Figure 22.7](#)) by guanine deaminase or by the reaction catalyzed by xanthine oxidase. These reactions are as follows:

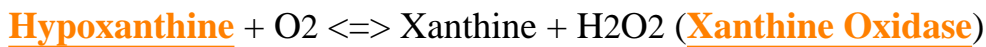
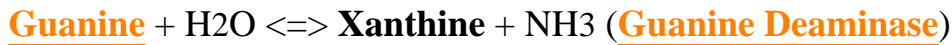
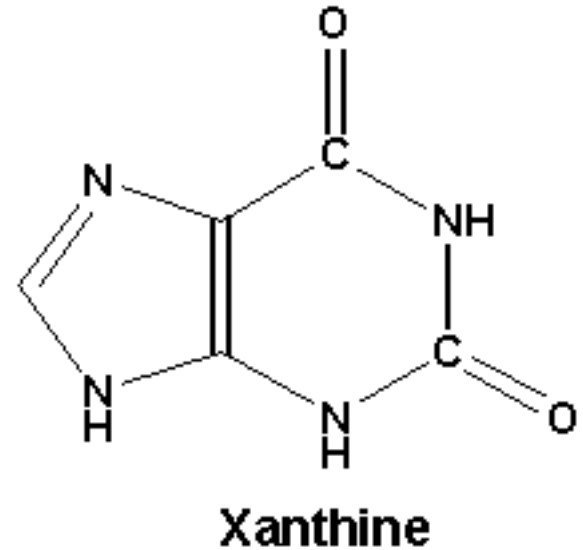

Xanthine oxidase can oxidize **xanthine** further to **uric acid**, as well ([Figure 22.7](#))

Allopurinol, which is similar to hypoxanthine (see [here](#)), is used to treat gout because it inhibits **xanthine oxidase**, leading to accumulation of hypoxanthine and **xanthine**, both of which are more soluble and more readily excreted than **uric acid** (the causative agent of gout).

See also: [Purine Degradation](#), [Excessive Uric Acid in Purine Degradation](#)

Guanine Deaminase

Guanine deaminase is an enzyme that catalyzes the reaction below:

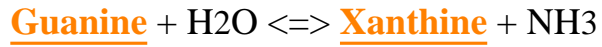

The reaction is a part of the purine catabolic pathway ([Figure 22.7](#))

See also: [Purine Degradation](#)

Allopurinol

Allopurinol is a drug that is used to treat gout. It is similar to **hypoxanthine** (see [here](#)) and inhibits **xanthine oxidase**, leading to accumulation of hypoxanthine and **xanthine**, both of which are more soluble and more readily excreted than **uric acid**, the compound responsible for causing gout.

See also: [Excessive Uric Acid in Purine Degradation](#)

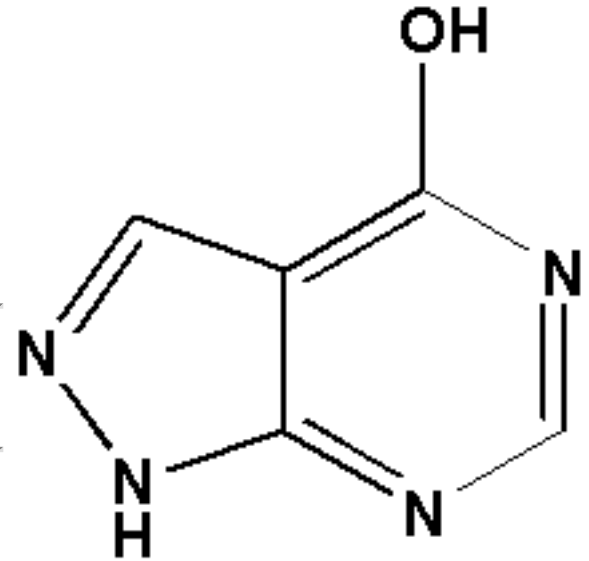

Allopurinol

Unnumbered Item

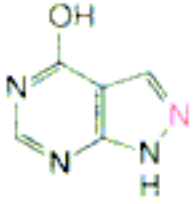

Allopurinol

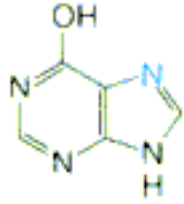

Hypoxanthine

Excessive Uric Acid in Purine Degradation

Uric acid and its urate salts are very insoluble and can present difficulties in mammalian metabolism. Hyperuricemia is a condition characterized by chronic elevation of blood **uric acid** levels beyond normal levels. Also known as gout, it affects 3 people in 1000. High levels of urate leads to precipitation of sodium urate in the synovial fluid of joints. Precipitates can cause inflammation, arthritis, and/or severe degeneration of the joints.

Figure 22.9 shows that gout can be caused by abnormalities in three different enzymes in purine metabolism.

PRPP synthetase - Defects in PRPP synthetase may render it insensitive to feedback inhibition by purine nucleotides. Thus, purine nucleotides are overproduced, leading to excessive **uric acid** synthesis and gout.

PRPP amidotransferase - Defects in PRPP amidotransferase may render it insensitive to feedback inhibition by purine nucleotides, too, leading to the overproduction of purine nucleotides, excessive **uric acid** synthesis, and gout.

Hypoxanthine-Guanine Phosphoribosyltransferase (HGPRT) - HGPRT is a salvage pathway enzyme for purine metabolism (another is specific for **adenine**). The relationship between a defect in this enzyme and gout is unclear, but it may be related to the fact that when HGPRT is active, it uses **PRPP**. The enzyme activity is not completely missing in gout patients, just at a low level. Complete absence of the enzymatic activity is associated with Lesch-Nyhan syndrome.

Gout can also be caused by defects in excreting **uric acid** (associated with the inability of the kidney tubules to secrete **uric acid**).

Cancer patients may experience gout as a result of chemotherapy, which generates many purines by nucleic acid degradation after cell death.

Allopurinol, which is similar to hypoxanthine (see [here](#)), is used to treat gout because it inhibits **xanthine oxidase**, leading to accumulation of **hypoxanthine** and **xanthine**, both of which are more soluble and more readily excreted than **uric acid**.

See also: [Purine Degradation](#), [Lesch-Nyhan Syndrome](#), [Immunodeficiency and Defective Purine Catabolism](#)

INTERNET LINK: [Purine Metabolism](#)

Figure 22.9: Enzymatic abnormalities in three types of gout.

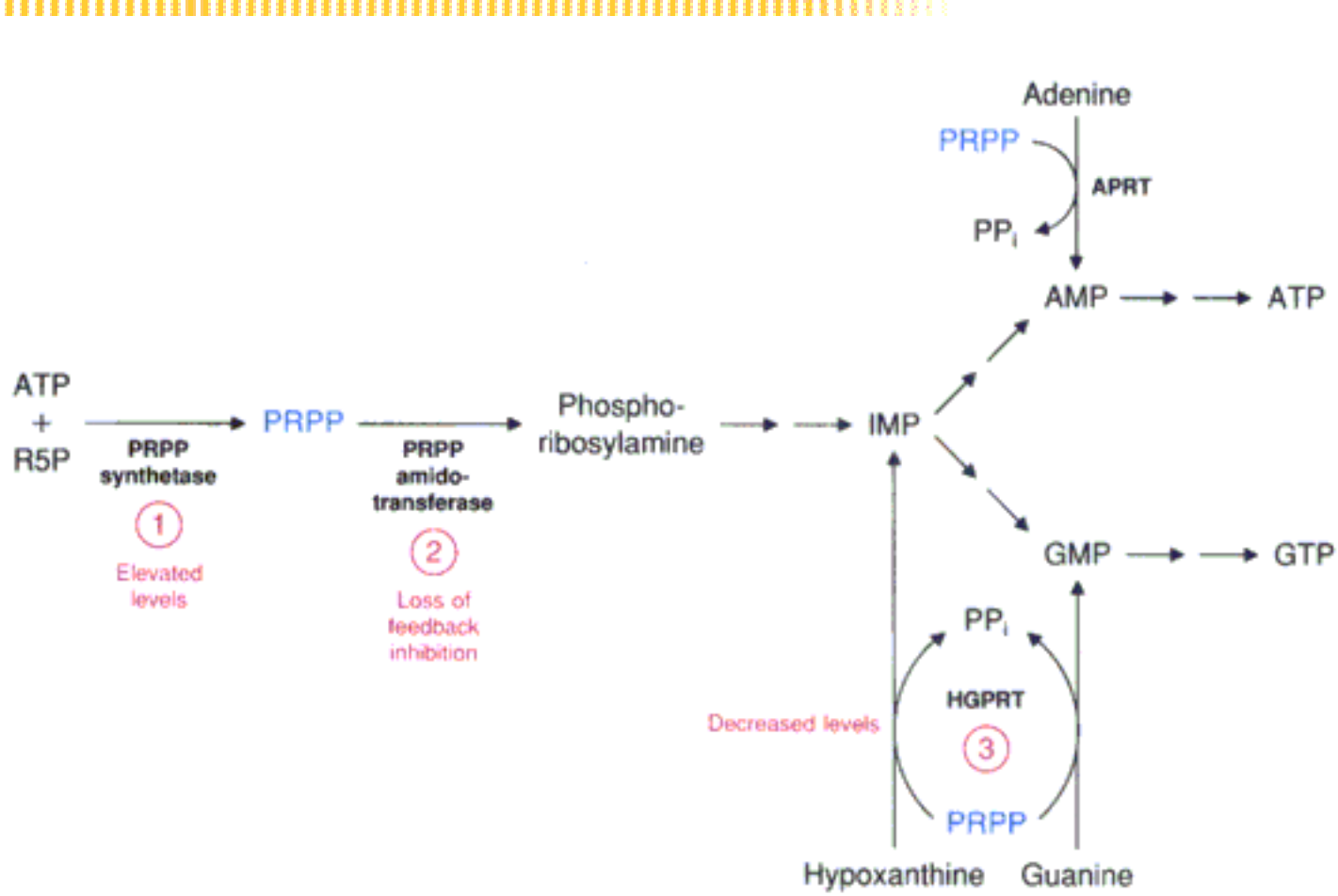

PRPP Amidotransferase

PRPP amidotransferase is an enzyme that catalyzes the reaction below:



PRPP amidotransferase is regulated allosterically by AMP, ADP, GMP, and GDP, which all inhibit the reaction.

See also: Figure 22.4, De Novo Biosynthesis of Purine Nucleotides, The Importance of PRPP

5-Phosphoribosylamine (PRA)

5-Phosphoribosylamine is an intermediate in de novo purine biosynthesis. It is produced in the reaction that follows, catalyzed by **PRPP amidotransferase**:

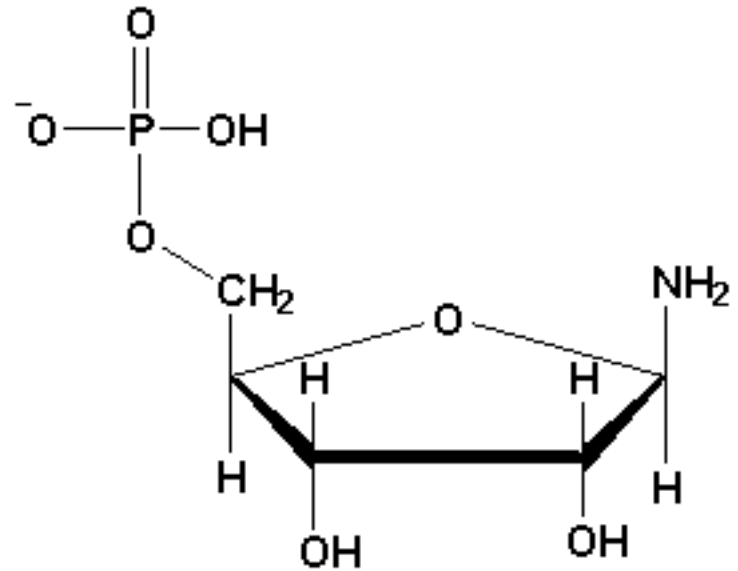

5-Phosphoribosylamine



See also: [Figure 22.4, De Novo Biosynthesis of Purine Nucleotides](#), [The Importance of PRPP](#)

The Importance of PRPP

5-Phospho- α -D-ribose-1-pyrophosphate (PRPP) is an intermediate in both the *de novo* synthesis of nucleotides ([Figure 22.1](#)) and the salvage synthesis (reutilization) of nucleotides ([Figure 22.2](#)).

PRPP is synthesized from [ribose-5-phosphate](#) as shown [here](#).

PRPP is converted to a nucleotide by addition of a base, as shown [here](#). This reaction is reversible, but it proceeds almost exclusively to the right in cells, due to the PPI product, which is readily cleaved by phosphodiesterases.

See also: [De Novo Biosynthesis of Purine Nucleotides](#), [PRPP Amidotransferase](#), [Figure 22.4](#)

INTERNET LINKS:

1. [Purine Metabolism](#)
 2. [Purine and Pyrimidine Metabolism](#)
-

Figure 22.1: Overview of nucleotide metabolism.

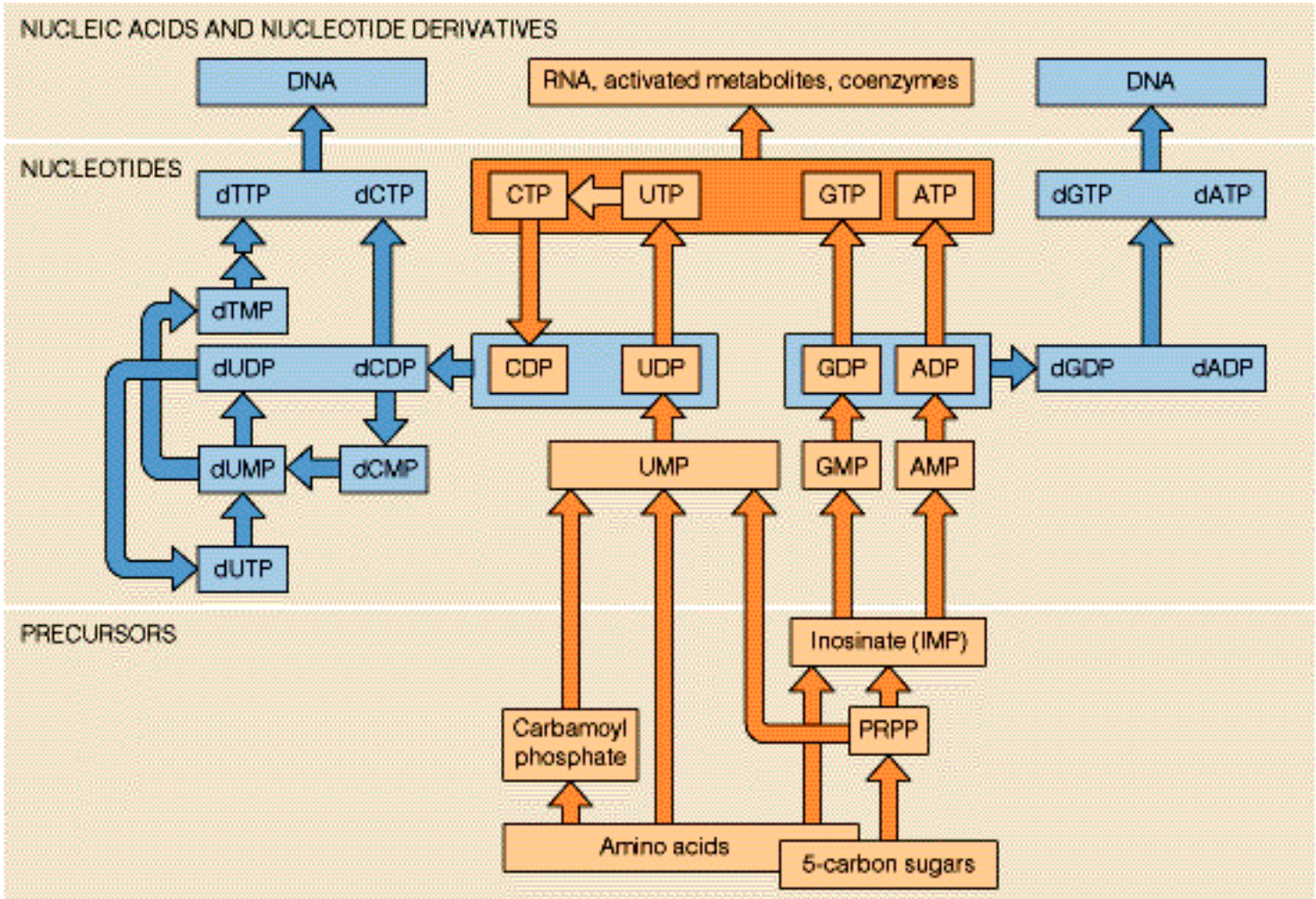

Hypoxanthine-Guanine Phosphoribosyltransferase (HGPRT)

HGPRT is a salvage pathway enzyme for purine metabolism (another is specific for [adenine](#)). It catalyzes conversion of [hypoxanthine](#) to [IMP](#) and [guanine](#) to [GMP](#) ([Figure 22.9](#)).

When **HGPRT** is present in low levels, the patients usually experience gout, a painful condition arising from precipitation of [uric acid](#) in the joints. The relationship of a defect in **HGPRT** to gout is unclear, but may be related to the fact that when the enzyme is active, it uses [PRPP](#). The enzyme activity is not completely missing in gout patients, just at a low level. Complete absence of **HGPRT** enzymatic activity is associated with [Lesch-Nyhan syndrome](#).

See also: [Excessive Uric Acid in Purine Degradation](#), [Purine Degradation](#), [Nucleotide Analogs in Selection](#)

INTERNET LINKS:

1. [Lesch-Nyhan Syndrome](#)
 2. [Purine Metabolism](#)
-

Lesch-Nyhan Syndrome

Hypoxanthine-guanine phosphoribosyltransferase (**HGPRT**) is a salvage pathway enzyme for purine metabolism (another is specific for adenine). When a defect in HGPRT reduces its activity to a low level, gout is the result. When the defect leads to the complete absence of activity of HGPRT, **Lesch-Nyhan syndrome** is the result. The gene for HGPRT is found on the X chromosome, so the disease is sex-linked. Patients have severe "gouty" arthritis and a dramatic malfunction of the nervous system, manifested as behavioral disorders, learning disabilities, and hostile or aggressive behavior, often self-directed. Individuals with **Lesch-Nyhan syndrome** rarely live beyond 20 years.

See also: [Excessive Uric Acid in Purine Degradation](#)

INTERNET LINK: [Lesch-Nyhan Syndrome](#)

Immunodeficiency and Defective Purine Catabolism

Persons with severe combined immune deficiency (SCID) are totally unable to mount an immune response to antigens. Both the B and T lymphocytes are affected. The disease arises from an inherited lack of a degradative enzyme, **adenosine deaminase (ADA)**. The reaction shown **here** illustrates the pathways affected. Lack of **ADA** allows deoxyadenosine triphosphate (**dATP**) to accumulate from the degradation of DNA. High dATP levels inhibit production of the other dNTPs needed for DNA replication because of their allosteric effects on the enzyme **ribonucleotide reductase**.

White blood cells are the most affected by lack of **ADA**. White blood cells must proliferate for an immune response to occur, and proliferation requires ample synthesis of DNA and its precursors. Thus, DNA replication is inhibited and white blood cells are unable to proliferate, a necessary step for antibody production.

See also: **Purine Degradation**, **The Immune Response** (from Chapter 7), **Antibody Structure** (from Chapter 7), **Generation of Antibody Diversity** (from Chapter 7)

Adenosine Deaminase

Persons with severe combined immune deficiency (SCID) are totally unable to mount an immune response to antigens. Both the B and T lymphocytes are affected. The disease arises from an inherited lack of a degradative enzyme, **adenosine deaminase (ADA)**. The reaction shown [here](#) illustrates the pathways affected.

Lack of **ADA** allows **dATP** to accumulate. High **dATP** levels inhibit production of the other dNTPs needed for DNA replication due to its effect on the [regulation of ribonucleotide reductase](#). White blood cells, which must proliferate for an immune response to occur, and which have abundant salvage enzymes for making dATP, are most affected by lack of the enzyme. They are unable to proliferate, a necessary step for antibody production.

See also: [Ribonucleotide Reductase](#), [The Immune Response](#), [T Cells and the Cellular Response](#)

INTERNET LINK: [Adenosine Deaminase](#)

Unnumbered Item

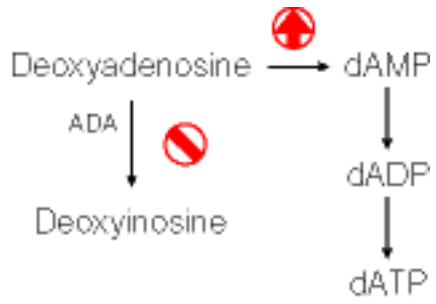

Cytidine Diphosphate (CDP)

CDP is a **ribonucleotide** formed metabolically from **CTP** by a phosphatase and converted to **dCDP** by ribonucleotide reductase (see below). CDP is a component of **CDP-diacylglycerol**, an important intermediate in glycerophospholipid biosynthesis. CDP is also linked to choline to form **CDP-choline** in the predominant mechanism of **phosphatidylcholine** synthesis. Note that though CDP appears in the names of the glycerophospholipid intermediates above, the molecule involved in the reactions making them is **CTP**, not CDP, so the reactions do not appear below.

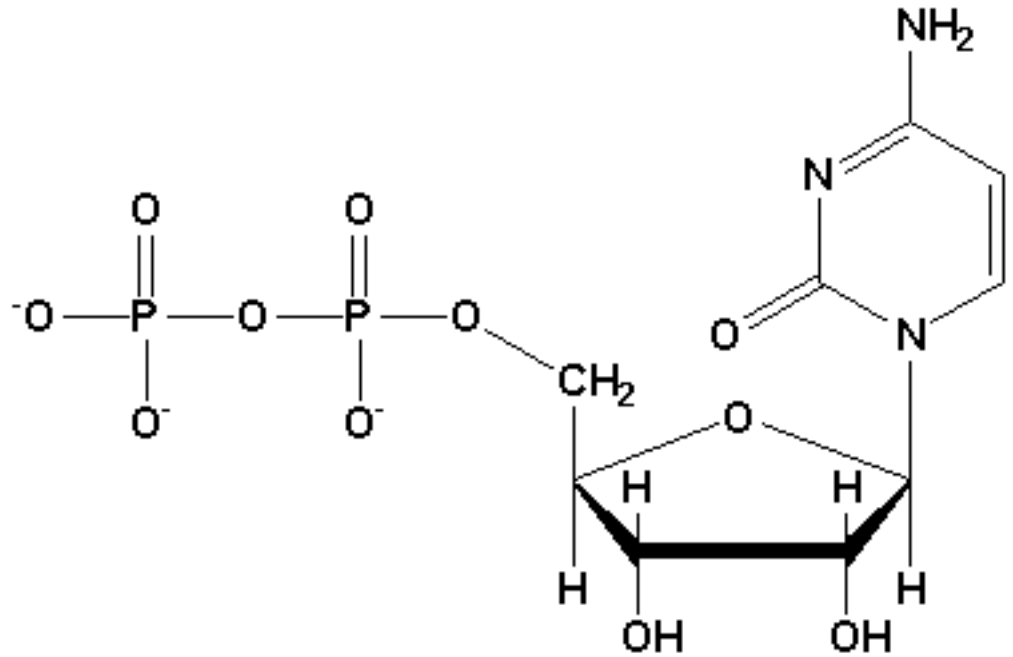

Cytidine diphosphate (CDP)

Reactions involving CDP:

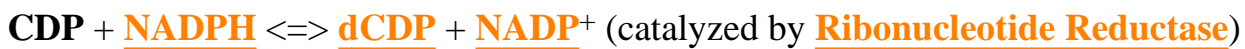
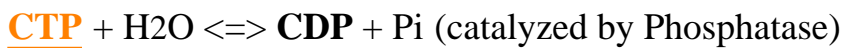

See also: **Nucleotides**, **Cytosine**

Deoxycytidine Diphosphate (dCDP)

dCDP is a deoxyribonucleotide made from CDP in the reaction catalyzed by **ribonucleotide reductase**, as follows:



Phosphorylation of **dCDP** yields **dCTP**, a substrate for DNA polymerase in synthesis of **DNA**.

See also: **Nucleotides**

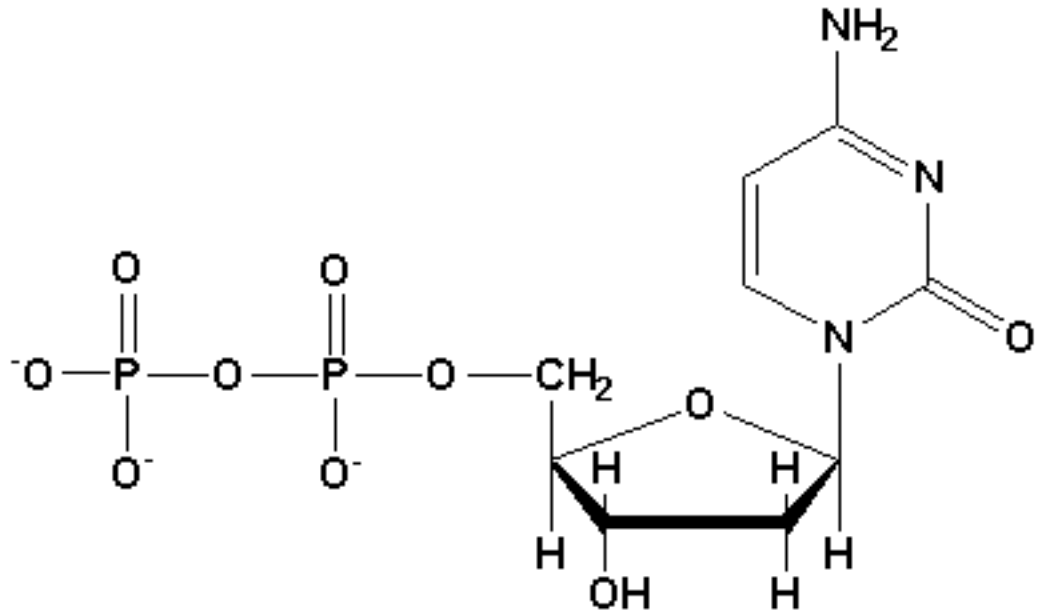

Deoxycytidine diphosphate (dCDP)

Homocysteine

Homocysteine is an intermediate in biosynthesis of [cysteine](#), [methionine](#), and in the breakdown of methionine. Recent research has indicated that elevated levels of **homocysteine** may correlate with increased incidence of vascular disease. Supplementation of diets with [folic acid](#), cobalamin and pyridoxine appear to provide protection by lowering **homocysteine** levels in the blood.

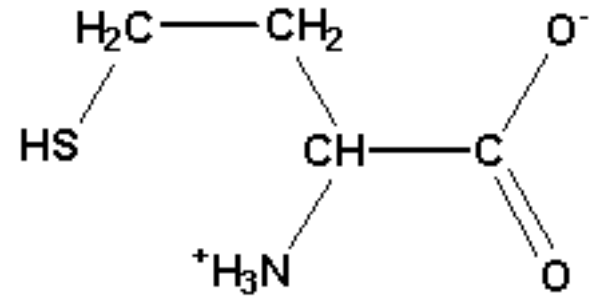

Homocysteine

See also: [Amino Acids Not In Proteins](#), [Vitamin B12](#), [Metabolism of Sulfur-Containing Amino Acids](#)

Folic Acid (Pteroylglutamic acid)

Coenzymes derived from the vitamin **folic acid** participate in the generation and utilization of single-carbon functional groups-methyl, methylene, and formyl. The vitamin itself was discovered in the 1930s, when it was found that people with a certain type of megaloblastic anemia could be cured by treatment with yeast or liver extracts. The condition is characterized, like all anemias, by reduced levels of erythrocytes. The cells that remain are characteristically large and immature, suggesting a role for the vitamin in cell proliferation and/or maturation. The vitamin is abundant in leafy green vegetables such as spinach, so is named folic acid, from the same root as foliage.

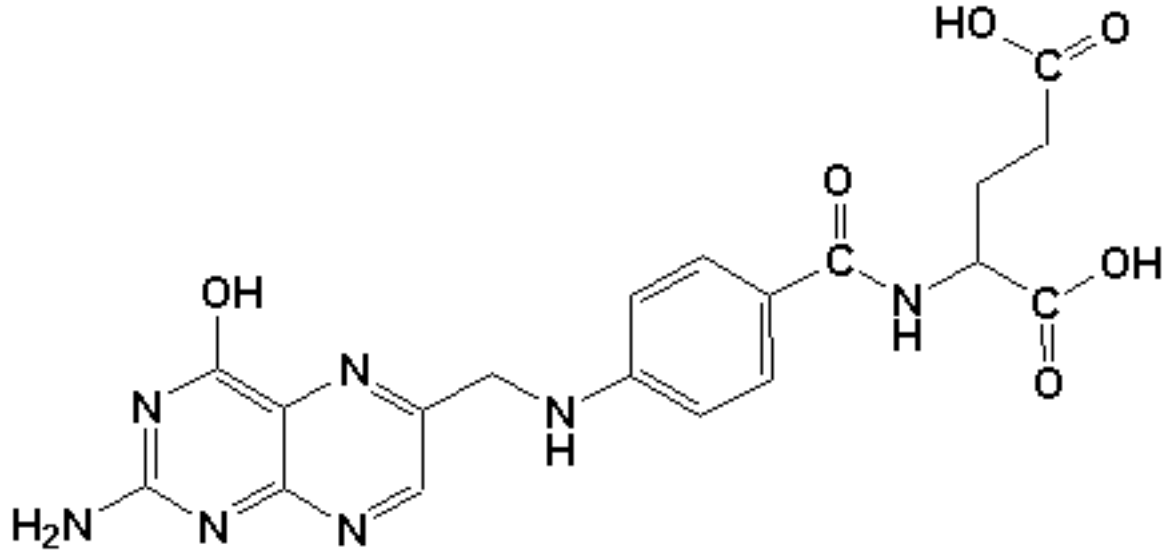

Folic Acid (pteroylglutamic acid)

Chemically, **folic acid** is formed from three distinct moieties: (1) a bicyclic, heterocyclic pteridine ring, **6-methylpterin** (see [here](#)); (2) **p-aminobenzoic acid (PABA)**, which is itself required for the growth of many bacteria; and (3) **glutamic acid**. Naturally occurring **folates** may differ from this compound in the number of glutamate residues per molecule of vitamin, which ranges from three to eight or more. These residues are linked to one another, not by the familiar peptide bond but rather by a modified peptide bond involving the α -amino group and the γ -carboxyl group.

See also: [Glutamate as a Precursor of Other Amino Acids](#), [Tetrahydrofolate Coenzymes](#)

Unnumbered Item

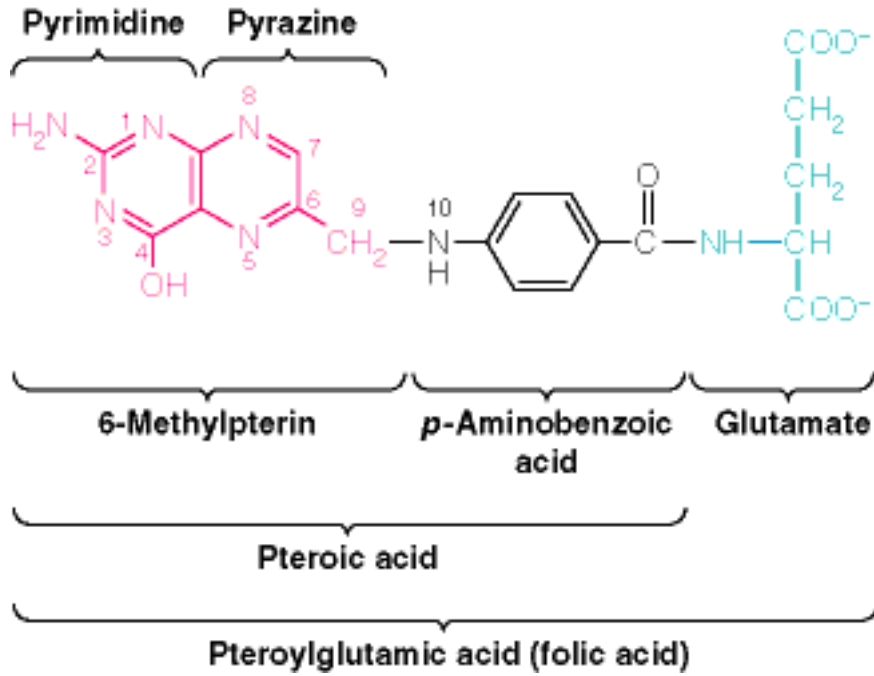

Glutamate as a Precursor to Other Amino Acids

Glutamate is one of the most metabolically active of all amino acids ([Figure 21.1](#)). It is a precursor to [glutamine](#), [arginine](#), [creatine phosphate](#) ([Figure 21.3](#)), [proline](#), [hydroxyproline](#), [polyamines](#), [glutathione](#), and γ -[aminobutyric acid \(GABA\)](#). GABA (see [here](#)), is a neurotransmitter, and is also involved in the synthesis of [glutathione](#). In addition, **glutamate** itself is a neurotransmitter.

[Figure 21.2](#) shows the sequence of reactions that converts **glutamate** to [ornithine](#) (a [urea cycle](#) intermediate). In this pathway, the energy-requiring reduction of glutamate to [glutamic \$\gamma\$ -semialdehyde](#) (see [here](#)) is comparable to the reduction of [aspartate](#) to [aspartic semialdehyde](#) (see [here](#)) and also leads to synthesis of [proline](#) (see [here](#)). In the synthesis of proline, however, cyclization is desirable because the cyclized product can be reduced with NADPH to proline.

Proline is incorporated into procollagen, the polypeptide precursor of [collagen](#). In procollagen, proline is converted to [hydroxyproline](#) by the enzyme [procollagen proline hydroxylase](#) ([Figure 21.4](#)). In order to carry out the conversion of procollagen to collagen, procollagen proline hydroxylase requires ascorbic acid ([vitamin C](#)), ferrous iron, molecular oxygen, and α -[ketoglutarate](#). Scurvy (caused by a vitamin C deficiency) leads to defects in connective tissue function, which are probably due to the defective synthesis or maturation of collagen in connective tissue.

In the structure of the vitamin [folic acid](#) (see [here](#) also), [6-methylpterin](#) is linked through the amino group of p-aminobenzoic acid ([PABA](#)) to form [pterioic acid](#), which is linked in turn via an amide to **glutamate**, to form pteroylmonoglutamate (see [here](#)). Naturally occurring folates may differ from this compound in the number of glutamate residues per molecule of vitamin, which ranges from three to eight or more. These residues are linked to one another, not by the familiar peptide bond but rather by a modified peptide bond between the α -amino group and the γ -carboxyl group. .

See also: [Urea Cycle](#) (from Chapter 20), [Citric Acid Cycle Intermediates in Amino Acid Metabolism](#), [Neurotransmitters and Biological Regulators](#), [Amino Acids](#)

INTERNET LINKS:

1. [Glutathione Metabolism](#)
2. [Valine, Leucine, and Isoleucine Biosynthesis](#)
3. [Glutamate Metabolism](#)

4. Urea Cycle

5. Arginine and Proline Metabolism

6. Folate Biosynthesis

Creatine Phosphate

Creatine phosphate shuttles high-energy phosphate from mitochondria to sites of muscle contraction. Careful observation of ATP levels in red striated muscle has shown that the provision of energy is more complicated than it might appear at first. The amount of ATP needed for a single contraction may be greater than all the ATP immediately available to a sarcomere. Yet even after relatively long exercise, ATP levels in the sarcomeres remain essentially constant. Only after extreme exhaustion do ATP levels begin to fall. This finding suggests that ATP is an intermediary, and not the ultimate, energy storage compound in these muscles. Indeed, it has been known for many years that the high-energy compound steadily depleted during muscular activity is **creatine phosphate**. An energy-rich muscle has lots of **creatine phosphate**, whereas a fatigued muscle has little **creatine phosphate**, and also has decreased ATP and increased ADP and AMP levels.

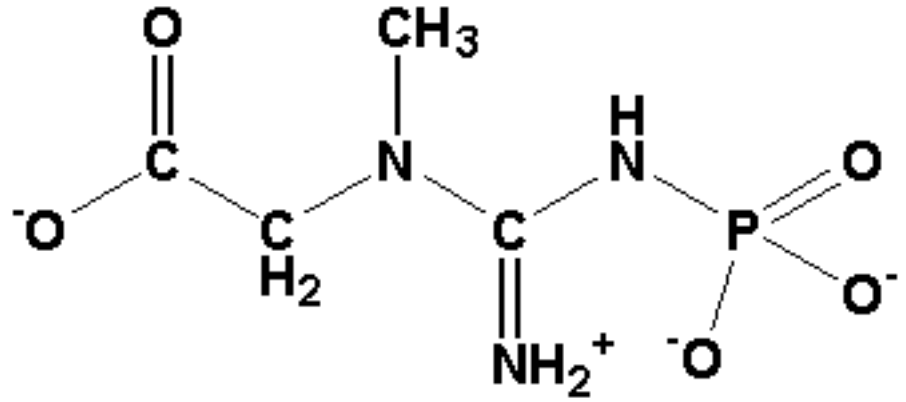

Creatine Phosphate

As its high phosphate transfer potential suggests (see [Figure 3.7](#)), this compound is capable of phosphorylating ADP very efficiently. The reaction is catalyzed by the enzyme [creatine kinase](#) as follows:



The reaction is strongly endergonic as written. However, the level of ATP is very high in mitochondria, so the reaction proceeds to the right. **Creatine phosphate** then diffuses from mitochondria to the myofibrils, where it provides the energy for muscle contraction. High levels of ADP formed in the myofibrils during contraction favor the reverse reaction namely, resynthesis of ATP - at the expense of **creatine phosphate** cleavage to creatine. This example shows that one must consider not only the standard free energy change but also the actual concentrations of all reactants and products when predicting the direction of a reaction in vivo.

Whether energy is stored as ATP or as a compound like **creatine phosphate**, that energy must eventually be made available as chemical energy, if it is to drive the synthesis of other high-energy compounds. It also can be transduced to other forms of energy, including mechanical energy or electrical energy. Transduction to mechanical energy occurs in muscle contraction or ciliary motion, whereas transduction to electrical energy occurs in membrane depolarization or in pumping ions across a membrane.

See also: [Energetics in Muscular Motion](#), [Important Points about Gibbs Free Energy](#), [Factors Contributing to Large Energies of Hydrolysis of Phosphate Compounds](#), [Metabolism of Ornithine and Arginine](#)

Figure 3.7: Hydrolysis reactions for some biochemically important phosphate compounds.

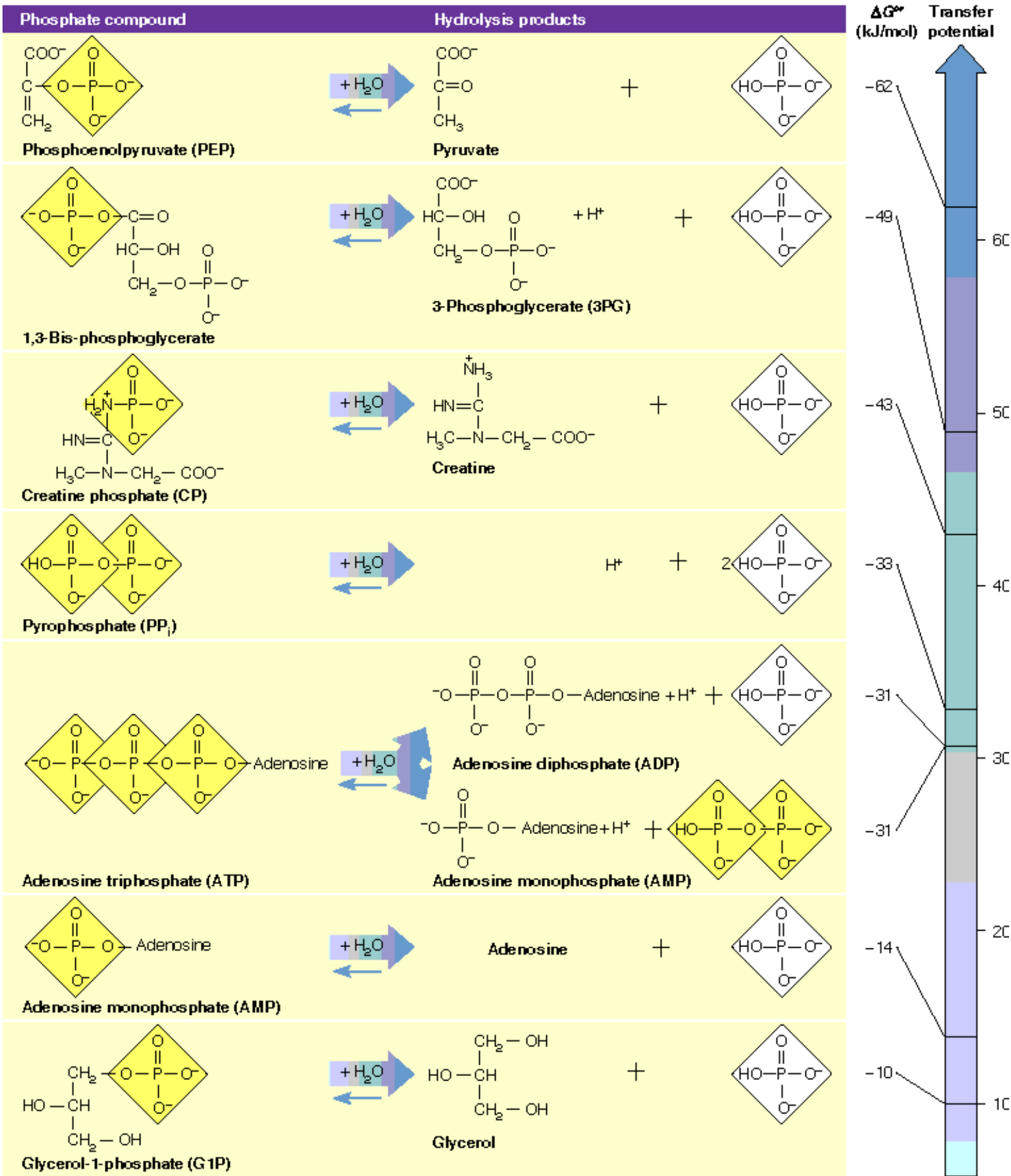



Creatine Kinase

Creatine kinase is an enzyme that catalyzes the reaction,



The reaction is strongly endergonic as written. However, the level of ATP is very high in mitochondria, so the reaction proceeds to the right. Creatine phosphate then diffuses from mitochondria to the myofibrils, where it provides the energy for muscle contraction. High levels of ADP formed in the myofibrils (see [here](#)) during contraction favor the reverse reaction namely, resynthesis of ATP - at the expense of creatine phosphate cleavage to creatine. This example shows that one must consider not only the standard free energy change but also the actual concentrations of all reactants and products when predicting the direction of a reaction in vivo.

See also: [Mitochondria](#), [Energetics in Muscular Motion](#), [Important Points About \$\Delta G\$](#)

Creatine

Creatine is a precursor of creatine phosphate, the compound that shuttles high-energy phosphate from mitochondria to sites of muscle contraction.

Creatine is formed by transmethylation of guanidinoacetate (derived from arginine) (reaction 1 below) and has three resonance forms, as follows:

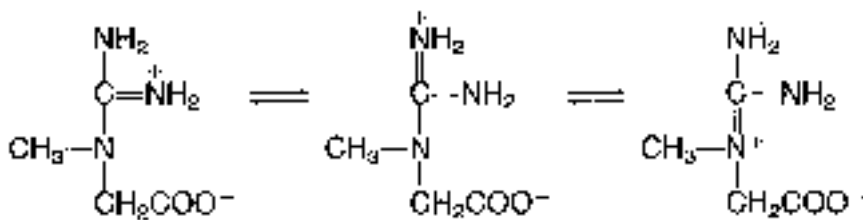
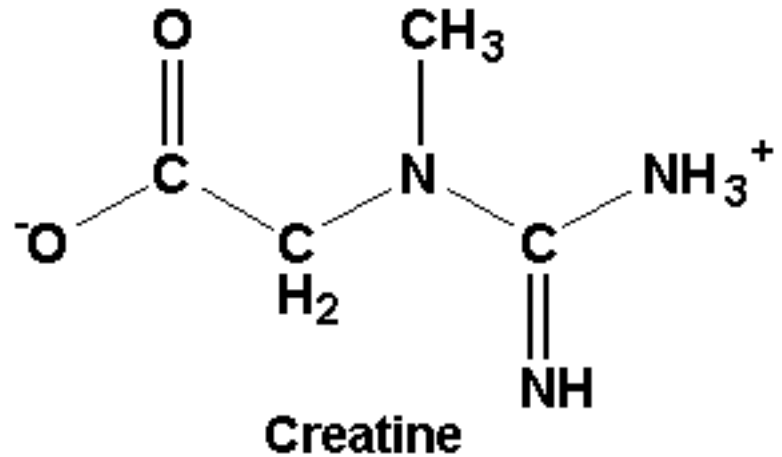

Creatine participates in the reactions that follow:

1. **Guanidinoacetate** + **S-Adenosylmethionine** \rightleftharpoons **Creatine** + **S-Adenosylhomocysteine**,
2. **Creatine** + **ATP** \rightleftharpoons **Creatine Phosphate** + **ADP** (catalyzed by **Creatine Kinase**)

The latter reaction is strongly endergonic as written. However, the level of ATP is very high in mitochondria, so the reaction proceeds to the right. Creatine phosphate then diffuses from mitochondria to the myofibrils (see [here](#)), where it provides the energy for muscle contraction.

High levels of ADP formed in the myofibrils during contraction favor the reverse reaction namely, resynthesis of ATP - at the expense of creatine phosphate cleavage to creatine. This example shows that one must consider not only the standard free energy change but also the actual concentrations of all reactants and products when predicting the direction of a reaction in vivo.

See also: [Arginine](#), [Mitochondria](#), [Energetics in Muscular Motion](#)

Guanidinoacetate

Guanidinoacetate is an intermediate in the biosynthesis of creatine, as follows:

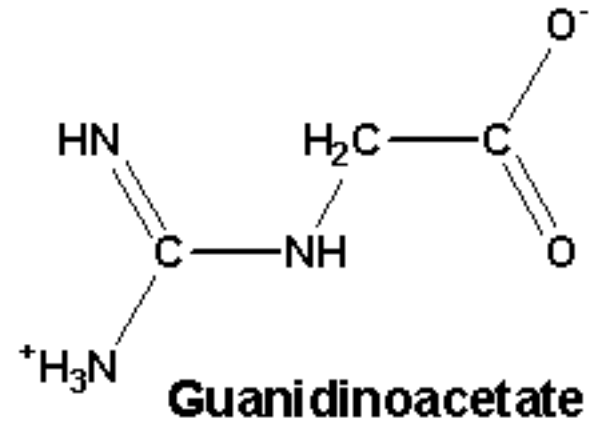

See also: **Energetics in Muscular Motion**

Energetics in Muscular Motion

Muscle converts chemical free **energy** from ATP hydrolysis into mechanical work with an efficiency approaching 80% under optimal circumstances. **ATP** is only an intermediary in **energy storage** in red muscles. Its concentration remains relatively constant during long exercise, as shown in the NMR studies of [Figure 12.14](#).

The **high-energy compound** steadily depleted during muscular activity is creatine phosphate (see [here](#)). Because the equilibrium for this reaction lies well to the right, virtually all of the muscle adenylate is maintained in the ATP form, rather than as **ADP** or **AMP**, as long as **creatine phosphate** is available. Thus, the **energy source** in red muscle is creatine phosphate, which regenerates ATP continually as it is depleted by muscle contraction.

[Table 8.1](#) compares the structures and **energy fuels** in white and red muscle.

See also: [The Structure of Muscle](#), [The Sliding Filament Model](#), [Creatine Phosphate](#)

Figure 12.14: Effect of anaerobic exercise on ^{31}P NMR spectra of human forearm muscle.

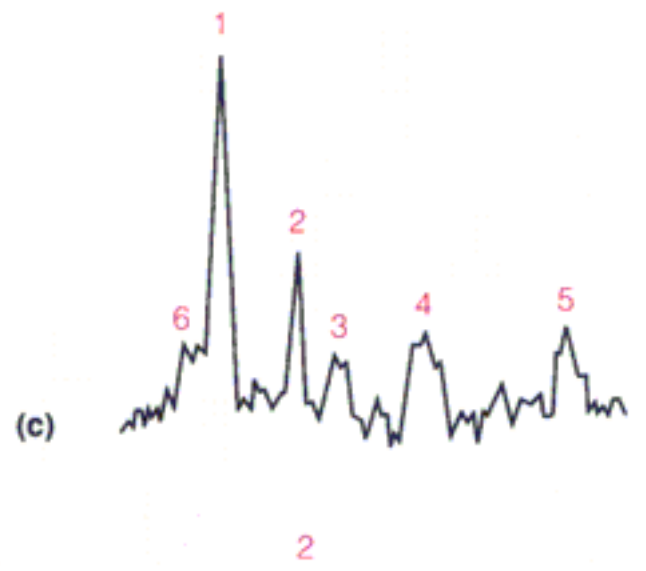
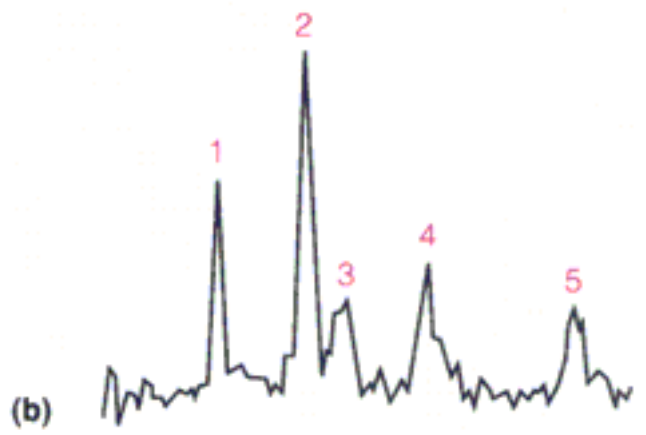
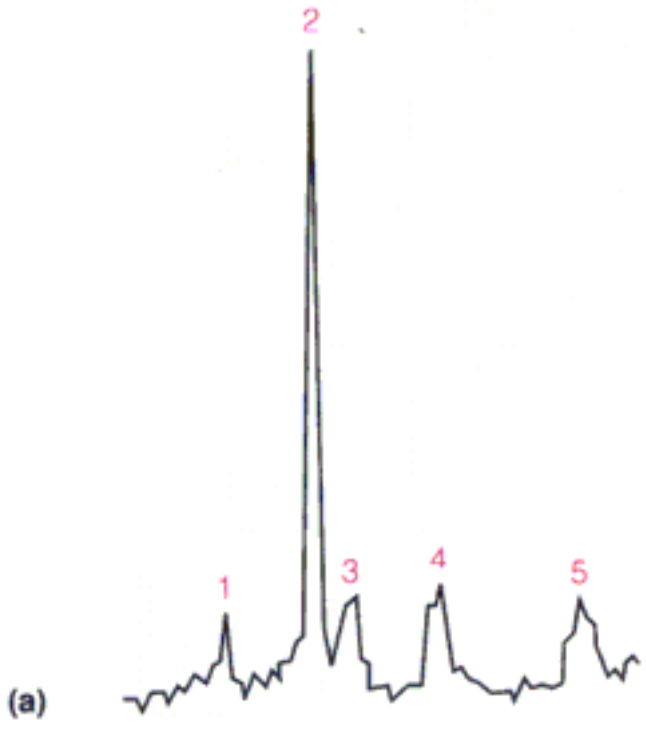

(c)

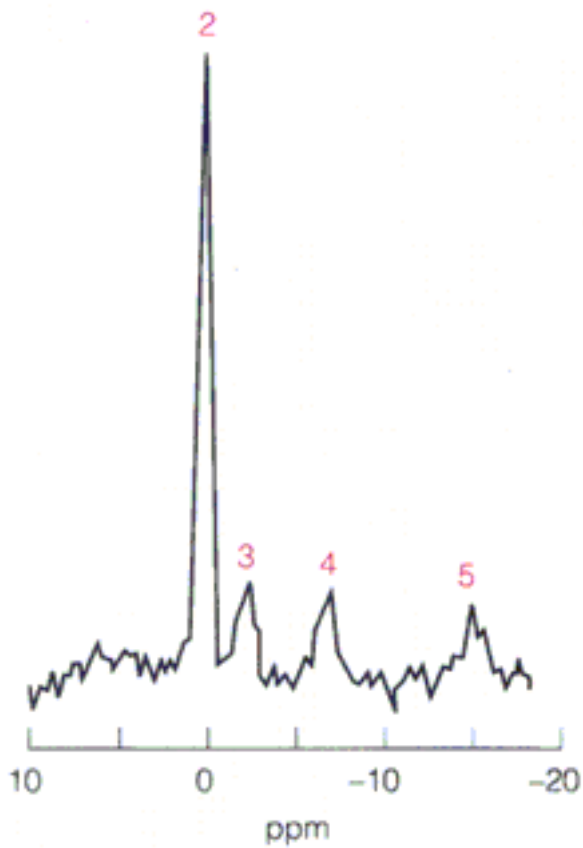

Reprinted with permission from G. K. Radda, *Science* (1988) 233:640-645. Copyright © 1988 by the AAAS.

Unnumbered Item

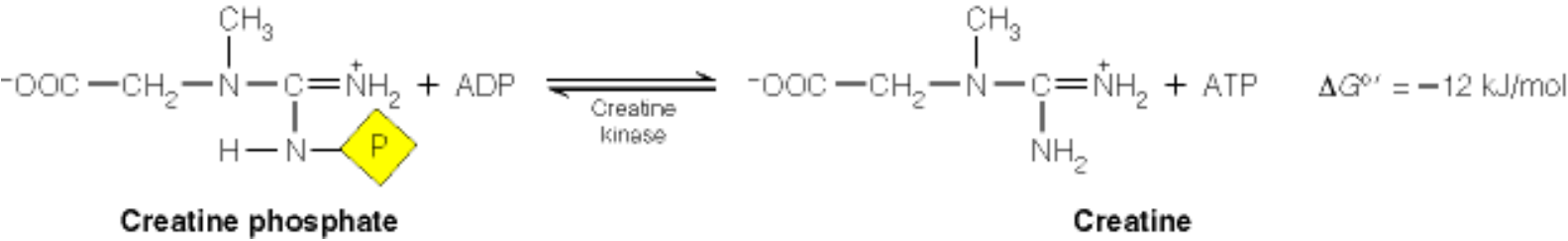

Table 8.1



	Red	White
Relative fiber size	Small	Large
Mode of contraction	Slow twitch	Fast twitch (about 5 times faster)
Vascularization	Heavy	Lighter
Mitochondria	Many	Few
Myoglobin	Much	Little
Major stored fuel	Fat cells	Glycogen in muscle
Main source of ATP	Fatty acid oxidation	Glycolysis

Important Points about ΔG

1. Three important terms relating to the free energy change of a process are:

ΔG - the total free energy change for a reaction under any conditions

ΔG° - free energy under standard conditions (all concentrations of 1M)

$\Delta G^{\circ'}$, the free energy change under standard biological conditions (all concentrations 1M, [H₂O] = constant, and pH = 7.0)

Thus, a positive ΔG° may influence a reaction, but cellular conditions may make the overall ΔG for the reaction negative.

2. ΔG and only ΔG determines whether a reaction is favorable as written.. Only when ΔG is negative is a reaction favored. **The sign of ΔG° or $\Delta G^{\circ'}$ does not determine the direction a reaction will proceed.**

3. ΔG depends on temperature ($\Delta G = \Delta H - T\Delta S$). This can be a factor for a given reaction occurring in different organisms living under very different conditions of temperature.

See also: [Free Energy and Useful Work](#), [Free Energy and Concentration](#), [Free Energy Change and the Equilibrium Constant](#)

Free Energy and Useful Work

The term ΔG represents the portion of an energy change (ΔH) that is available to do useful work. If ΔH is the total energy in a reaction, then $\Delta G = \Delta H - T\Delta S$ indicates that part of ΔH is always dissipated as heat (the $T\Delta S$ term) and is therefore unavailable for other things, such as muscle contraction, ion transport, or tissue growth. The remaining amount (ΔG) is available for useful work, but may not actually be fully utilized for useful work because the efficiency of a process (the ratio of work actually accomplished to ΔG , the maximum work available) is always less than 100%.

See also: [Internal Energy \(E\)](#), [Enthalpy](#), [Interplay of Enthalpy and Entropy](#)

Internal Energy (E)

The **internal energy** of a biochemical system includes any kind of energy that might be changed by any chemical or biochemical reaction. Examples include the kinetic energy of motion and the energy of vibration and rotation of every atom, molecule and ion in the system. Other examples include all of the energy stored in the chemical bonds between atoms and the energy of noncovalent interactions between molecules and ions. The **internal energy** of a system is a function of its state. That is, the **internal energy** depends only on the initial and final states of the system, not on the path taken to get from the initial state to the final state. The thermodynamic state of a system is defined by prescribing the amounts of all substances and any two of the following three system variables:

- 1) Temperature (T)
- 2) Pressure (P)
- 3) Volume (V)

An open system can exchange energy with its surroundings and may therefore change its internal energy. This change is called ΔE . **Internal energy** exchanges can only involve heat (q) or work (w). This is the first law of thermodynamics: $\Delta E = q - w$, where a positive value of q indicates heat absorbed by the system from its surroundings and a positive value of w indicates work is done by the system on its surroundings. Conversely, a negative value of q means that heat flows from the the system to its surroundings and a negative value of w means that the surroundings do work on the system.

When V is changed against a constant P, $w = P\Delta V$ or, using the ideal gas law,

$$w = \Delta nRT.$$

See also: [Enthalpy](#), [Entropy and the Second Law of Thermodynamics](#), [Interplay of Enthalpy and Entropy](#)

Enthalpy

The **enthalpy (H)** is defined as $H = E + PV$. Where E is the internal energy, P is the pressure, and V is the volume.

At constant pressure, $\Delta H = \Delta E + P\Delta V$. The same result can be obtained from the first law of thermodynamics:

$$\Delta E = q - w, \text{ so}$$

$$q = \Delta E + w, \text{ but } w = P\Delta V \text{ when } V \text{ is changed against a constant } P, \text{ so}$$

$$q = \Delta E + P\Delta V$$

Thus, when the heat of a reaction is measured at constant pressure, it is really ΔH that is measured. Furthermore, most biological processes occur at constant pressure, so ΔH gives a more accurate measure of the energy available from a biological process than ΔE does. Finally, because E and PV are functions of state (not path), H is also a function of state. Thus, ΔH depends only on the initial and final states of the process for which it is calculated.

See also: [Internal Energy \(E\)](#), [Interplay of Enthalpy and Entropy](#)

Interplay of Enthalpy and Entropy

Table 3.3 summarizes how the balance between enthalpy and entropy determines the direction in which a process is thermodynamically favorable. However, keep in mind the following:

1. The favorability of a process (negative ΔG) has nothing to do with reaction rate.
2. The entropy of an open system can decrease, but energy must be expended to do so, however.

See also: [Internal Energy \(E\)](#), [Enthalpy](#)

Table 3.3



ΔH	ΔS	Low T	High T
+	+	ΔG positive; not favored	ΔG negative; favored
+	-	ΔG positive; not favored	ΔG positive; not favored
-	+	ΔG negative; favored	ΔG negative; favored
-	-	ΔG negative; favored	ΔG positive; not favored

Entropy and the Second Law of Thermodynamics

ΔE and ΔH describe the energy changes, but tell nothing about the favored direction for a process. To do this, one must take into account the degree of randomness or disorder of a system. The degree of randomness or disorder of a system is measured by a state function called the **Entropy (S)**. **Entropy** is defined as $S = k \ln(W)$, where k is the Boltzmann constant (the gas constant R divided by Avogadro's number) and W is the number of thermodynamic substates of equal energy.

The **entropy** of an ordered state is lower than that of a disordered state of the same system. For example, there are more ways to put a large number of molecules in a random or disorderly arrangement than there are to put them in an orderly arrangement. Thus, the increasing entropy in a system is a thermodynamic driving force.

The **second law of thermodynamics** states that the **entropy** of an isolated system will tend to increase to a maximum value. However, this form of the **second law** is of little use biologically because it applies only to isolated systems (systems that do not exchange energy with their surroundings). Most biological systems, however, are open - they exchange energy and matter with their surroundings. Thus, biological systems undergo changes in energy and **entropy** in many reactions, and both must determine the direction of thermodynamically favorable processes. The Gibbs Free Energy (G) is a function of state that includes both energy and **entropy** terms:

$G = H - TS$, where T is the absolute temperature, H (the enthalpy) measures the energy change at constant pressure, and S (the **entropy**) measures the randomness of the system. At constant temperature and pressure,

$$\Delta G = \Delta H - T \Delta S$$

A decrease in energy ($-\Delta H$) and/or an increase in entropy ($+\Delta S$) tends to make a process favorable. Either a negative ΔH or a positive ΔS tends to make ΔG negative. Thus, the **second law** can be restated for open systems as follows:

1. ΔG must be negative for a process in an open system to be favorable at constant temperature and pressure.
2. A positive ΔG indicates a process is not favorable.

See also: [Internal Energy \(E\)](#), [Enthalpy](#)

Free Energy and Concentration

Standard state represents a 1M solution. The chemical potential of a component A (G_A) is equal to the chemical potential at the standard state plus $RT \ln[A]$

$$G_A = G_A^\circ + RT \ln [A] \quad (3.15b)$$

$$G_B = G_B^\circ + RT \ln [B]$$

etc.

At $[A] = 1M$, $G_A = G_A^\circ$

Consider moving molecule A from one side of a membrane through which A can pass (region 1) to the other (region 2).

The free energy of moving A out of region 1 is given by

$$\Delta G_1 = - \Delta G_A^\circ - RT \ln[A]_1$$

The free energy of moving A into region 2 is given by

$$\Delta G_2 = +\Delta G_A^\circ - RT \ln[A]_2$$

Overall,

$$\Delta G = \Delta G_1 + \Delta G_2 = RT(\ln[A]_2 - \ln[A]_1) = RT \ln([A]_2/[A]_1)$$

Thus, if the concentration of A in region 2 is lower than in region 1, ΔG is negative and the process is favorable. On the other hand, if the concentration of A in region 2 is higher than in region 1, ΔG is positive and the process is unfavorable

See also: [Internal energy \(E\)](#), [Enthalpy](#), [Interplay of Enthalpy and Entropy](#), [Important Differences Between \$\Delta G'\$ and \$\Delta G^{\circ'}\$](#)

Important Differences Between $\Delta G'$ and $\Delta G^0'$

If ATP is the free energy "currency" of a cell, how does a cell synthesize a compound (such as [creatine phosphate](#)) with a much higher phosphate transfer potential than that of ATP?

First, $\Delta G^0'$ values for **ATP** hydrolysis do not represent actual $\Delta G'$ values under likely biological conditions. ATP has a considerably higher $\Delta G'$ value at intracellular concentrations of ATP, ADP, and AMP than it has under standard conditions.

For example, consider the following reaction, catalyzed by [creatine kinase](#):



This reaction is endergonic ($\Delta G^0' = +12$ kcal/mol) under standard conditions but, because ATP levels are very high within mitochondria, and creatine phosphate levels are relatively low, the reaction is exergonic as written and proceeds to the right. Thus, the cellular concentration of metabolites has a drastic effect on the free energy for a reaction, enabling ATP to create phosphorylated compounds with higher phosphoryl transfer potential than itself under standard conditions.

See also: [ATP as Free Energy Currency](#), [Free Energy and Concentration](#) (from Chapter 3), [Important Points about \$\Delta G\$](#) (from chapter 3)

ATP as Free Energy Currency

ATP is metastable (a thermodynamically unstable compound that does not rapidly break down in absence of a catalyst) and is commonly referred to as "free energy currency." Like monetary currency, **ATP** is used to provide energy in a wide variety of metabolic reactions and is universal among cells. Nevertheless, the energy content of **ATP** is not significantly different from other nucleoside di- and tri-phosphates. For whatever reason, however, evolution has created an array of enzymes that preferentially bind **ATP** and use its free energy of hydrolysis to drive endergonic reactions. Hydrolysis of either phosphoanhydride bond in **ATP** has a $\Delta G^{\circ\prime}$ of about -31 kJ/mol. Be aware, however, that utilization of that energy to drive endergonic reactions usually does NOT involve hydrolysis of **ATP**. Instead, **ATP** breakdown is usually coupled with a thermodynamically unfavorable reaction. In glycolysis, for example, **ATP** energy is used to synthesize glucose-6-phosphate from glucose. In this case, the phosphate is transferred directly from **ATP** to glucose to form glucose-6-phosphate.

Because **ATP** can transfer a phosphate group, we say that **ATP** has a high "phosphoryl group transfer potential" rather than calling it a high energy compound. The phosphate anhydride bonds of **ATP**, **ADP**, or pyrophosphate have relatively high $\Delta G^{\circ\prime}$ values. In fact, they are roughly twice as high as the phosphate ester bonds of **glucose-6-phosphate** or **AMP** (see also - **Figure 3.8**). There are, however, cellular compounds with even higher phosphoryl group transfer potentials than **ATP**. For example, the $\Delta G^{\circ\prime}$ for breakdown of phosphoenolpyruvate (PEP), 1,3-bisphosphoglycerate, and creatine phosphate are -62, -49, and -43 kJ/mol, respectively. Although the breakdown of "super-high-energy" compounds, such as PEP, is not used routinely in cells to drive endergonic reactions, these compounds are still important because they can be used to drive the synthesis of **ATP** from **ADP** + **Pi**. In fact, this coupling, called **substrate level phosphorylation**, is the process by which **ATP** is synthesized in glycolysis.

ATP hydrolysis under cellular conditions yields **ADP** + **Pi** or **AMP** + **PPi**: The energy available from **ATP** hydrolysis is probably not -31 kJ/mol (see above), however, for several reasons:

1. $\Delta G^{\circ\prime}$ values for **ATP** hydrolysis do not represent actual $\Delta G'$ values under likely biological conditions;
 2. $\Delta G'$ depends on temperature;
 3. $\Delta G^{\circ\prime}$ is defined at pH = 7.0, but actual pH may vary from 6.5 to 8.0;
 4. Varying amounts of magnesium ion will change ΔG in complicated ways;
 5. Actual concentrations of **ATP**, **ADP**, and **Pi** in cells are very different from the 1M value of the standard state of $\Delta G^{\circ\prime}$;
 6. Effective $\Delta G'$ values in cells may be close to -50 kJ/mol; and
 7. Thus, **ATP** hydrolysis is very effective in driving cellular processes.
-

See also: Substrate Level Phosphorylation, Oxidation as a Metabolic Energy Source, Factors Contributing to Large Energies of Hydrolysis of Phosphate Compounds (from chapter 3)

Figure 3.8: The ATP molecule and its hydrolysis reactions.

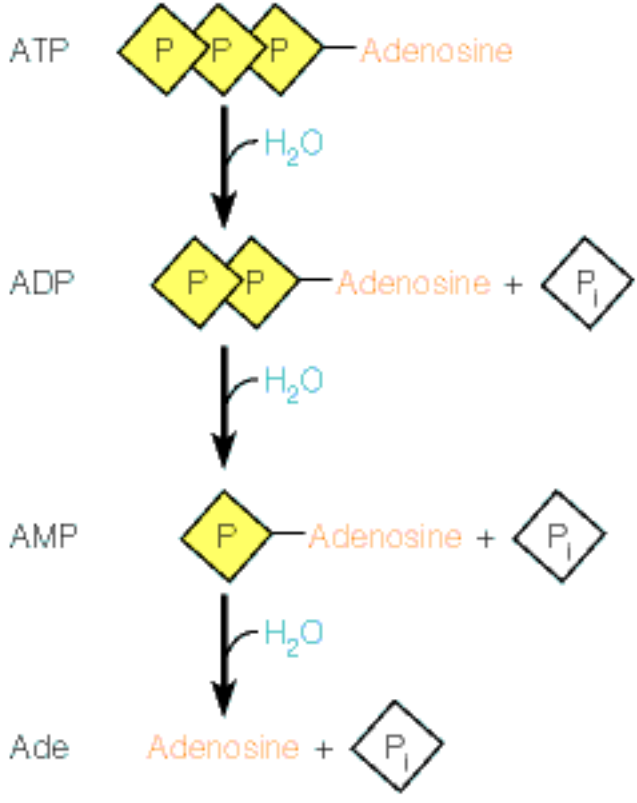
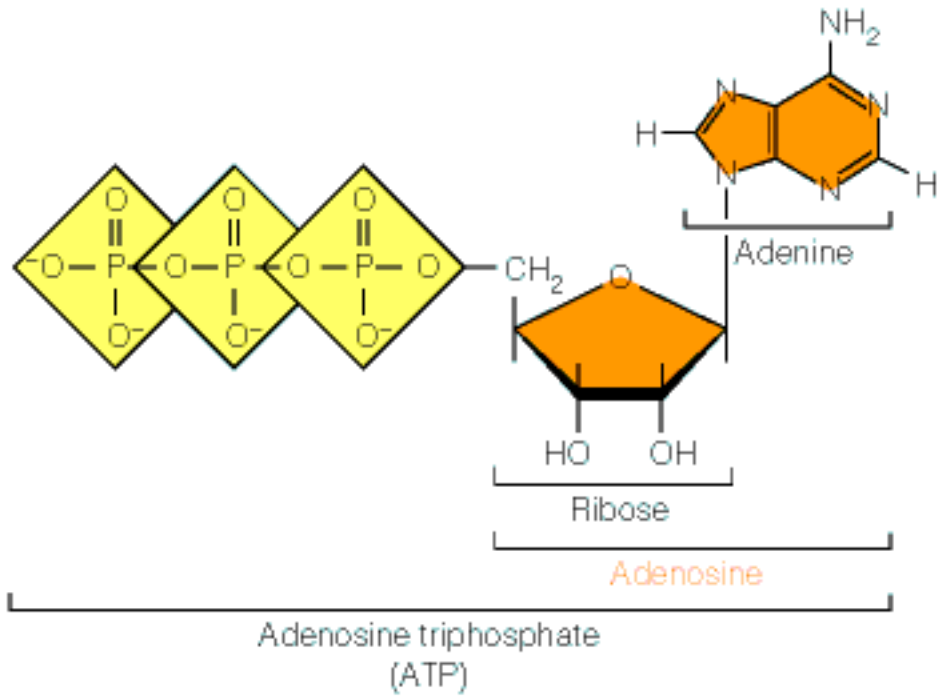

31 kJ/mol of energy is released when ATP becomes ADP

31 kJ/mol of energy is released when ADP becomes AMP

14 kJ/mol of energy is released when the adenosine-phosphate bond is cut

Substrate Level Phosphorylation

Substrate-level phosphorylations occur when a "high-energy" phosphate containing molecule transfers phosphate to ADP in a chemical reaction to form ATP. Two examples of this type of reaction occur in glycolysis:

1. The reaction catalyzed by the enzyme phosphoglycerate kinase. In this reaction, a high energy phosphate from 1,3 bisphosphoglycerate is transferred to ADP to form ATP and 3-phosphoglycerate.
2. The reaction catalyzed by the enzyme pyruvate kinase. Here, a high energy phosphate is transferred from PEP to ADP to form ATP and pyruvate.

See also: Phosphorylations

Phosphorylation Mechanisms

Three types of **phosphorylations** for making ATP occur in cells. They are:

1. Substrate-level phosphorylation
2. Oxidative phosphorylation
3. Photophosphorylation

See also: Glycolysis, Oxidative Phosphorylation (from Chapter 15), Photosynthesis (From chapter 17)

Photophosphorylation



Photophosphorylation occurs when energy from light is used to form a proton gradient across the thylakoid membrane of chloroplasts. Dissipation of the proton gradient drives ATP-synthase phosphorylation of ADP to yield ATP. **Photophosphorylation** is an important part of the process of photosynthesis.

See also: [Basic Processes of Photosynthesis](#) (from Chapter 17)

Basic Processes of Photosynthesis

Photosynthesis is a plant process (in [chloroplasts](#)) whereby energy from light is harvested to provide carbohydrates for energy production ([Figure 17.1](#)). It is the major path through which carbon reenters the biosphere (from CO₂). **Photosynthesis** is also the major source of oxygen in the earth's atmosphere.

Photosynthetic organisms probably first appeared about 3.5 billion years ago. The Earth's atmosphere before that was probably devoid of oxygen (though rich in carbon dioxide).

The reaction for **photosynthesis** can be written in a general way as shown in [here](#). The term, [CH₂O], represents a generalized carbohydrate. Because the reverse reaction is an oxidation, the reaction as written must be a reduction. In this case, H₂O is shown as the source of electrons (ultimate reducing agent). This is the case in plants, most algae, and cyanobacteria. Other **photosynthetic** bacteria use other reductants, so a more general reaction for photosynthesis is that given [here](#), where H₂A is the general reductant and A is the oxidized product. Some example reactions of this type are shown in [Table 17.1](#).

The source of the oxygen released as a result of **photosynthesis** in plants, algae, and cyanobacteria is H₂O. To reflect this, the reaction for photosynthesis can also more clearly be written as shown [here](#). Light energy has no direct effect on this reaction and H₂O has no known way to directly reduce CO₂. Thus, **photosynthesis** is a much more intricate process than these equations suggest.

[Figure 17.3](#) depicts schematically the way in which light energy transfers electrons from H₂O to CO₂ and how oxygen is released.

1. Photochemical oxidation of H₂O - Energy from light causes electrons from H₂O to be transferred (with protons) to NADP⁺, forming NADPH, and releasing O₂. This series of steps is sometimes called the light reactions.
2. Part of the energy of from the sunlight is captured in a process called photophosphorylation in which ADP is phosphorylated to form ATP. The remaining reactions of photosynthesis are not dependent upon light and are part of what are called the dark reactions of photosynthesis. They do NOT, however, occur only in the dark. They are, in fact, stimulated by light.

In the dark reactions of **photosynthesis**, NADPH and ATP produced by the light reactions are used in the reductive synthesis of carbohydrate from CO₂ and water.

See also: [Calvin Cycle](#), [Photosystem II](#), [Photosystem I](#), [Photosystem Summary](#), [Carbohydrates](#) (from chapter 9), [NADPH](#), [The Energy of Light](#), [Photochemistry](#)

Chloroplasts

In all higher plants and algae, photosynthetic processes are localized in organelles called **chloroplasts**. In plants, most of the **chloroplasts** are found in cells just under the leaf surface (mesophyll cells). Each cell may contain 20 to 50 of these organelles. The eukaryotic algae also have **chloroplasts**, but often only one very large one is found in each cell.

Like mitochondria, **chloroplasts** are semiautonomous, carrying their own DNA to code for some of their proteins, as well as the ribosomes necessary for translation of the appropriate messenger RNAs. There is now much evidence that **chloroplasts** evolved from unicellular organisms similar to cyanobacteria (blue-green algae). Such prokaryotic photosynthesizers do not contain **chloroplasts** but have membrane structures that play the same roles as **chloroplast** membranes. To a certain extent, the cyanobacteria resemble free-living **chloroplasts**. It is believed that, early in evolution, primitive unicellular organisms took up cyanobacteria-like prokaryotes and that eventually the relationship became symbiotic: The photosynthetic organelles were no longer capable of independent life, and the algae depended upon them as energy sources.

Some **chloroplast** genes are coded in the organelle genome, and some are in the cell nucleus.

See also: [Figure 1.13, Basic Process of Photosynthesis](#), [Figure 17.4c](#), [The Chloroplast](#)

Figure 17.1: The carbon cycle in nature.

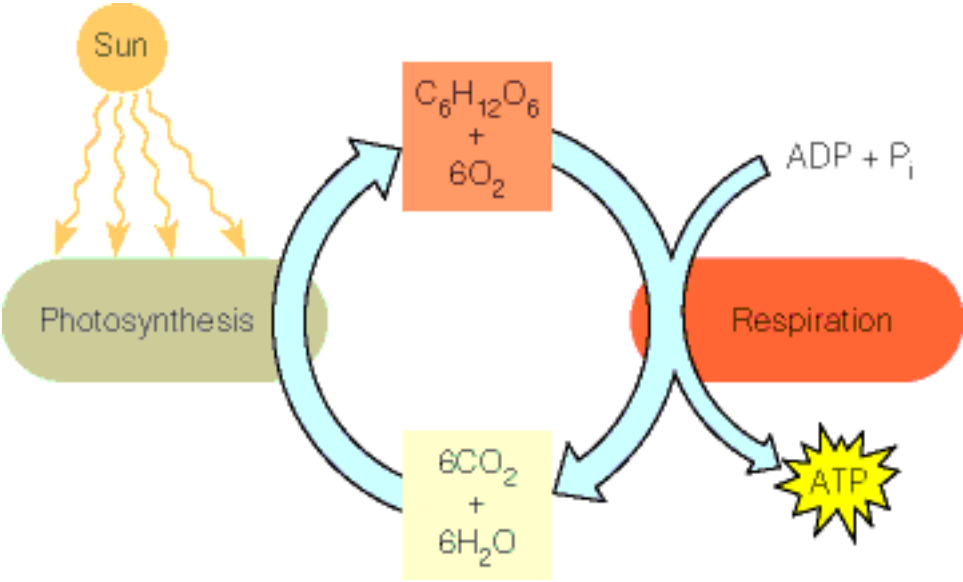

Unnumbered Item



Unnumbered Item



Table 17.1



Organisms	Reductant	Reaction
Plants, algae, cyanobacteria	H ₂ O	CO ₂ + 2H ₂ O → [CH ₂ O] + H ₂ O + O ₂
Green sulfur bacteria	H ₂ S	CO ₂ + 2H ₂ S → [CH ₂ O] + H ₂ O + 2S
Purple sulfur bacteria	[HSO ₃ ⁻]	CO ₂ + H ₂ O + 2[HSO ₃ ⁻] → [CH ₂ O] + 2[HSO ₄ ⁻]
Nonsulfur photosynthetic bacteria	H ₂ or many other reductants, such as lactate	CO ₂ + 2H ₂ → [CH ₂ O] + H ₂ O
		$CO_2 + 2 \left(\begin{array}{c} CH_3 \\ \\ HC - OH \\ \\ COO^- \end{array} \right) \longrightarrow [CH_2O] + H_2O + 2 \left(\begin{array}{c} CH_3 \\ \\ C = O \\ \\ COO^- \end{array} \right)$ <div style="display: flex; justify-content: space-around; width: 100%;"> Lactate Pyruvate </div>

Unnumbered Item



Figure 17.3: The two subprocesses of photosynthesis.

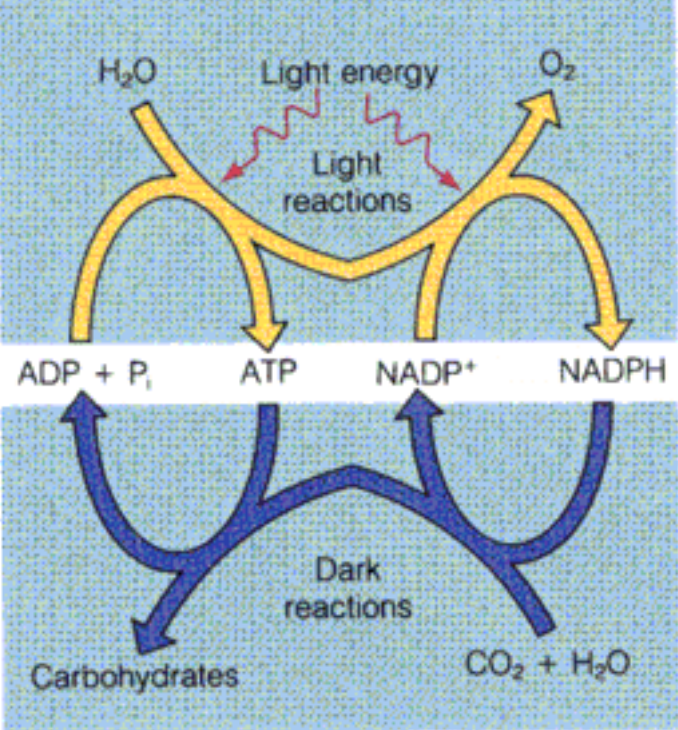

Photosystem I

Both Photosystem II (PSII) and **Photosystem I (PSI)** contain an electron transport chain, which extracts energy when an excited electron loses its energy of excitation in a stepwise fashion. The photosystem carries out a series of oxidation/reduction reactions similar to those in electron transport. The terminal electron acceptor of **PSI** is NADP^+ , forming NADPH.

PSI is a multi-protein complex, containing at least 11 polypeptide chains, antenna chlorophylls, and a reaction center chlorophyll (P700) which can absorb light of up to 700 nm. Photon absorption by antenna chlorophylls raises P700 electrons to an excited state of about -1.3 V. Each excited electron then passes through a transport chain as follows (see also [Figure 17.12](#)):

1. [A0](#) (a chlorophyll-like acceptor);
2. A1 (protein-bound [phyloquinone](#), also known as vitamin K1);
3. Three FeS proteins - [FX](#), [FB](#), and [FA](#), each of which has an FeS cluster like those shown in [Figure 15.4](#);
4. Soluble [ferredoxin](#) (Fd), another FeS protein present in the stroma;
5. [NADP⁺](#) → [NADPH](#)

The transfer of electrons from reduced Fd to NADP^+ is catalyzed by the enzyme ferredoxin:NADP⁺ oxidoreductase (FNR):



In a sense Fd, rather than NADP^+ , is the direct recipient of electrons from **PSI**. For example, much of the reduced Fd is used to reduce NADP^+ , but some is used for other reductive reactions, too, such as the reduction of [thioredoxin](#) ([Figure 17.23](#)). Ferredoxin can also use electrons to reduce substances and may also be considered the final electron accepting molecule of **PSI**.

The NADPH produced by Fd oxidation is released into the stroma, where it will be used in the [Calvin cycle](#) (the photosynthetic dark reactions).

At this point, P700 has been left in the oxidized state, P700^+ . In cells with two photosystems, the electrons are replaced by [plastocyanin](#) from [PSII](#).

The overall reaction of **PSI** is summarized [here](#).

See also: , [Photosystem Summary](#), [Cyclic Electron Flow](#), [Chlorophyll](#), [Reaction Center](#), [FNR](#), [Figure 17.16](#)

A0



A0 is a part of [photosystem I](#) in plants. **A0** accepts an excited electron from a reaction center chlorophyll, P700 ([Figure 17.12](#)) and passes it to the molecule called [phylloquinone](#) (also called A1 or vitamin K1).

See also: [Reaction Center](#), [Photosystem Summary](#)

Phylloquinone A1

Phylloquinone A1 (also known as **vitamin K1**) is an electron carrier in the system leading from photosystem I to **NADP**⁺ (**Figure 17.12**). A1 accepts electrons from A0 and donates them to the **FX** iron sulfur protein.

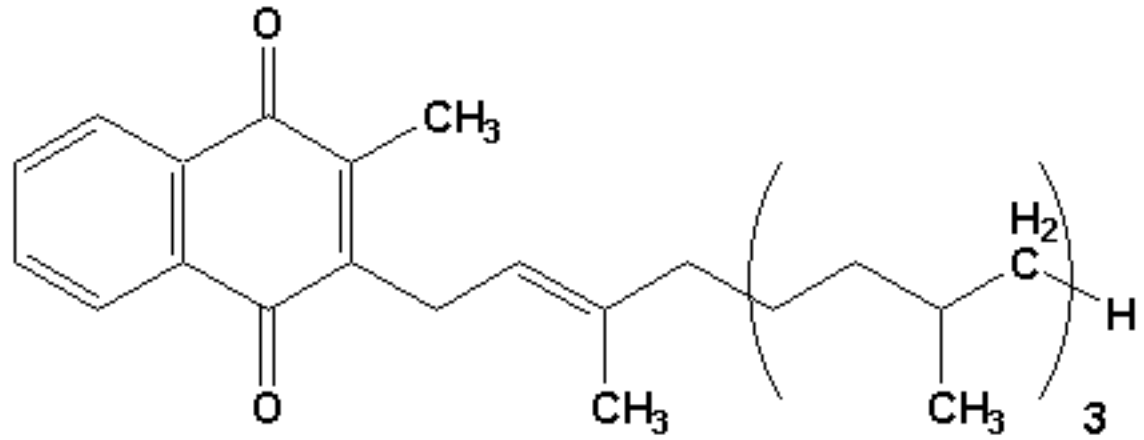

Phylloquinone A1

See also: [Photosystem I](#),
[Photosystem Summary](#),
[FX](#)

FX



Proteins **F_A**, **F_B**, and **F_X** are all iron-sulfur proteins that carry electrons from P700 in photosystem I to **NADP⁺** to form **NADPH**. The electrons pass from protein-bound phylloquinone (**A1**) to **F_X** to **F_A** to **F_B** and then to **ferredoxin** (Fd) (**Figure 17.12**).

See also: [Photosystem I](#), [Photosystem Summary](#)

FA



Proteins **FA**, **FB**, and **FX** are all iron-sulfur proteins that carry electrons from P700 in photosystem I to **NADP**⁺ to form **NADPH**. The electrons pass from protein-bound phylloquinone (**A1**) to **FX** to **FA** to **FB** and then to **ferredoxin** (Fd) (**Figure 17.12**).

See also: [Photosystem I](#), [Photosystem Summary](#)

F

Proteins FA, **FB**, and FX are all iron-sulfur proteins that carry electrons from P700 in photosystem I to **NADP**⁺ to form **NADPH**. The electrons pass from protein-bound phylloquinone (**A1**) to **FX** to **FA** to **FB** and then to **ferredoxin** (Fd) (**Figure 17.12**).

See also: [Photosystem I](#), [Photosystem Summary](#)

Ferredoxin (Fd)

Ferredoxin is a soluble iron sulfur protein in the stroma of the chloroplast that carries electrons in photosystem II. **Ferredoxin** accepts electrons from the iron-sulfur protein, FB, and passes them to **NADP⁺** in the last step of electron transport. In a sense **ferredoxin**, rather than NADP⁺, can be considered the direct recipient of electrons from the pathway because reduced **ferredoxin** is a source of low-potential electrons for many reductive processes, such as the reduction of **thioredoxin** (for example, see [Figure 17.23](#)).

Ferredoxin is used by [nitrogenase reductase](#) (component II), an enzyme of nitrogen fixation, and also by [nitrite reductase](#), which catalyzes reduction of nitrite to ammonia

See also: [Photosystem II](#), [Photosystem Summary](#), [Cyclic Electron Flow](#), [FX](#), [FB](#), [FA](#), [FNR](#), [Nitrogen Fixation](#) (from Chapter 19)

Thioredoxin

Thioredoxin is a small protein that carries two reversibly oxidizable sulfhydryl (-SH) groups that participates in a wide variety of reduction/oxidation reactions. In photosynthesis regulation, reduction of **thioredoxin** is promoted by oxidation of the reduced form of **ferredoxin**. In strongly irradiated chloroplasts, in which **NADP⁺** stores are depleted, reduced ferredoxin accumulates. High levels of reduced ferredoxin yield reduced thioredoxin, which thereby lead to activation of the Calvin cycle enzymes (**Figure 17.23**), stimulating the **Calvin cycle reactions** when the light reactions are very active. The same compound, reduced **thioredoxin**, also stimulates the **CF0-CF1 complexes**, ensuring a high rate of ATP generation when illumination is intense.

Thioredoxin is also a potential carrier of electrons to **ribonucleotide reductase** for reduction of **ribose** to **deoxyribose**. A proposed mechanism of action of ribonucleotide reductase is shown in **Figure 22.15**.

Thioredoxin is also involved in reducing sulfate in sulfur fixation (see **here**)

Some of the interesting biological activities of **thioredoxin** are listed in **Table 22.1**.

See also: **Ribonucleotide Reductase and Deoxyribonucleotide Biosynthesis**, **Regulation of Photosynthesis**, **Metabolism of Sulfur-Containing Amino Acids**

Figure 17.23: Light-dependent activation of dark-reaction enzymes.

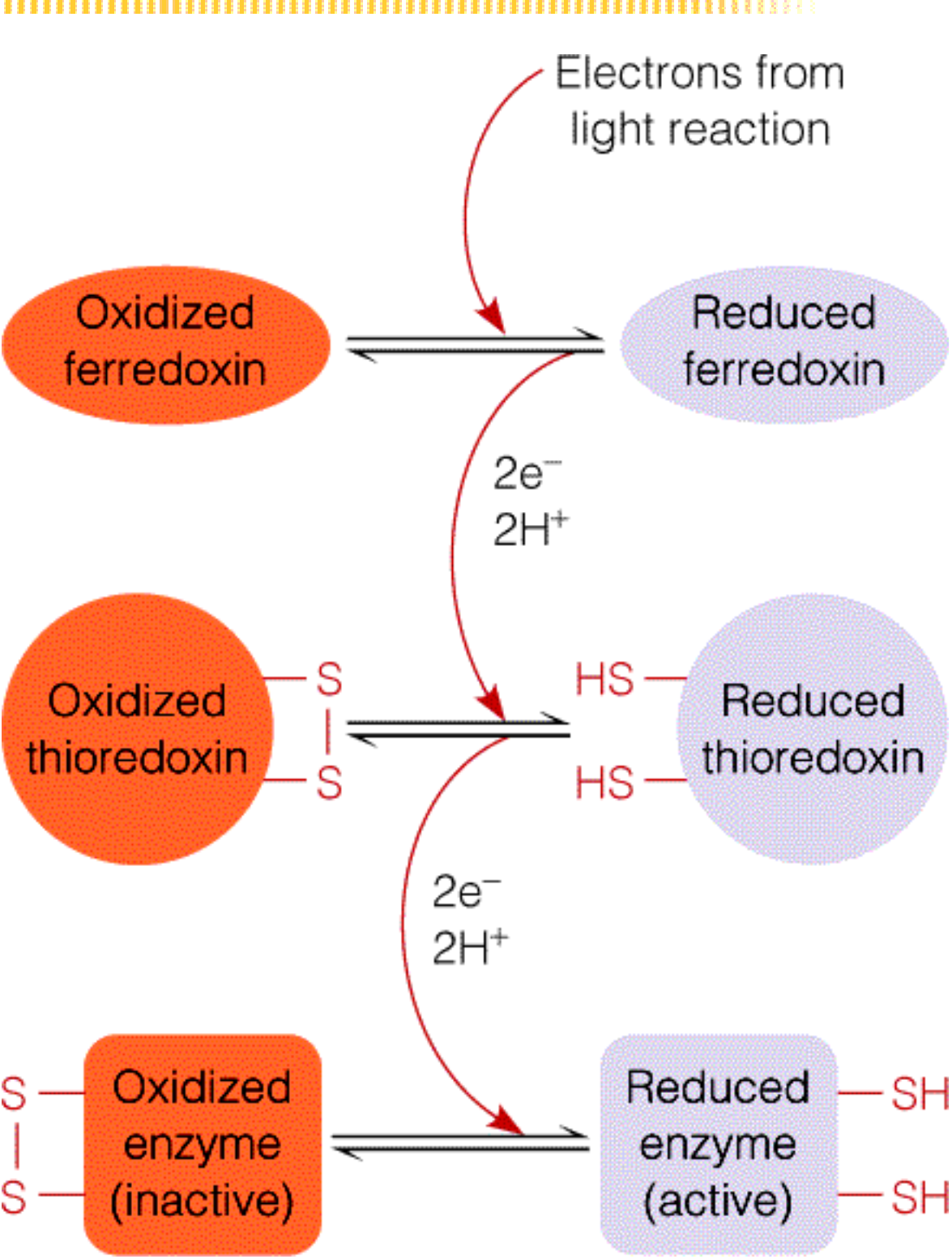

Figure 22.15: Reduction of a ribonucleoside diphosphate by rNDP reductase.

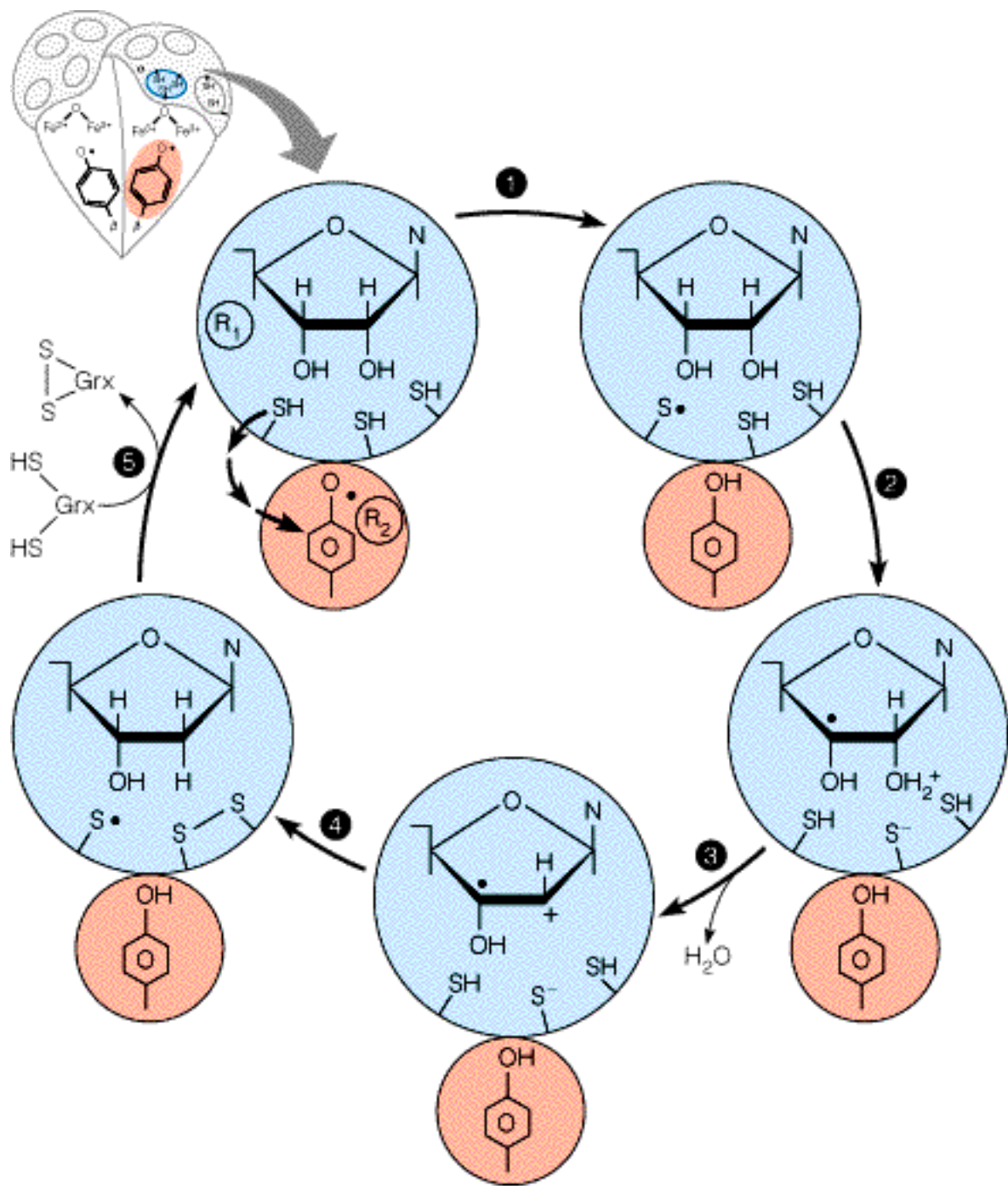

Table 22.1



Activity	Organism
Cofactor for ribonucleotide reduction	All organisms
Protein folding (thioredoxin promotes correct disulfide bond formation)	All organisms
Possible control of insulin levels, through control of insulin reduction	Animals
Control of melanin formation (people with high levels of thioredoxin reductase tan easily)	Animals
Regulation of photosynthetic carbon fixation (see Chapter 17)	Plants
Sulfite reduction (see Chapter 21)	Plants, bacteria
Essential subunit of viral DNA polymerase	Bacteriophage T7
Maturation of filamentous phages by an unknown mechanism	Single-stranded DNA bacteriophages

Regulation of Photosynthesis

The dark reactions of **photosynthesis** are actually stimulated by the light reactions. The central enzyme in the dark reactions, **ribulose-1,5-bisphosphate carboxylase**, is stimulated by high pH and CO₂ and Mg²⁺. Remember that pumping of protons from the stroma increases the pH. As protons are lost from the stroma due to pumping, Mg²⁺ enters to replace the lost charges.

Three other enzymes of the Calvin cycle are activated by reduction of disulfides to sulfhydryls. These enzymes are **sedoheptulose-1,7-bisphosphatase** (**Figure 17.22**), **glyceradehyde-3-phosphate dehydrogenase**, and **ribulose-5-phosphate kinase**. This disulfide reduction reaction is dependent upon a disulfide exchange reaction promoted by the protein **thioredoxin** (**Figure 17.23**). In this reaction, thioredoxin becomes oxidized and must be reduced to function again. Reduction is catalyzed by the ferredoxin-thioredoxin reductase, and uses electrons from **ferredoxin** (**Figure 17.23**). High levels of ferredoxin accumulate when **NADP**⁺ stores are low, and this occurs during light exposure. Thus, when light is present, the **Calvin cycle** is stimulated. It should be noted that thioredoxin has another effect - it stimulates the **CF0-CF1 complexes** as well.

In the dark, plants must metabolize some of the stored energy. In general, the pathways of catabolism - **glycolysis**, the **citric acid cycle**, and the **pentose phosphate pathway** - are inhibited in the presence of sunlight and become more active in the dark. The key light-inhibited enzymes are **phosphofructokinase** (from glycolysis) and **glucose-6-phosphate dehydrogenase** (pentose phosphate pathway). The latter enzyme also can be reduced by thioredoxin, but in this case the reduction causes inhibition of the enzyme.

See also: **Photosystem II**, **Photosystem I**

Phosphatase (Sedoheptulose-1,7-Bisphosphatase)

Phosphatase is the common name given for the enzyme that catalyzes the following reaction from the Calvin cycle:

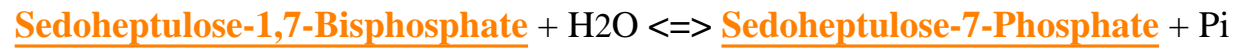

Unlike most other Calvin cycle reactions, this one has no counterpart in the pentose phosphate pathway.

See also: [Calvin Cycle](#), [Pentose Phosphate Pathway](#)

Sedoheptulose-1,7-Bisphosphate

Sedoheptulose-1,7-Bisphosphate is an intermediate in the Calvin cycle. It is produced in the reaction that follows:



and is subsequently converted to sedoheptulose-7-phosphate by the enzyme Phosphatase.

See also: Calvin Cycle, Calvin Cycle Reactions

Aldolase



Aldolase is an enzyme in the Calvin cycle that catalyzes the reaction below:



See also: Calvin Cycle Reactions

Figure 17.22: Regeneration phase of the Calvin cycle.

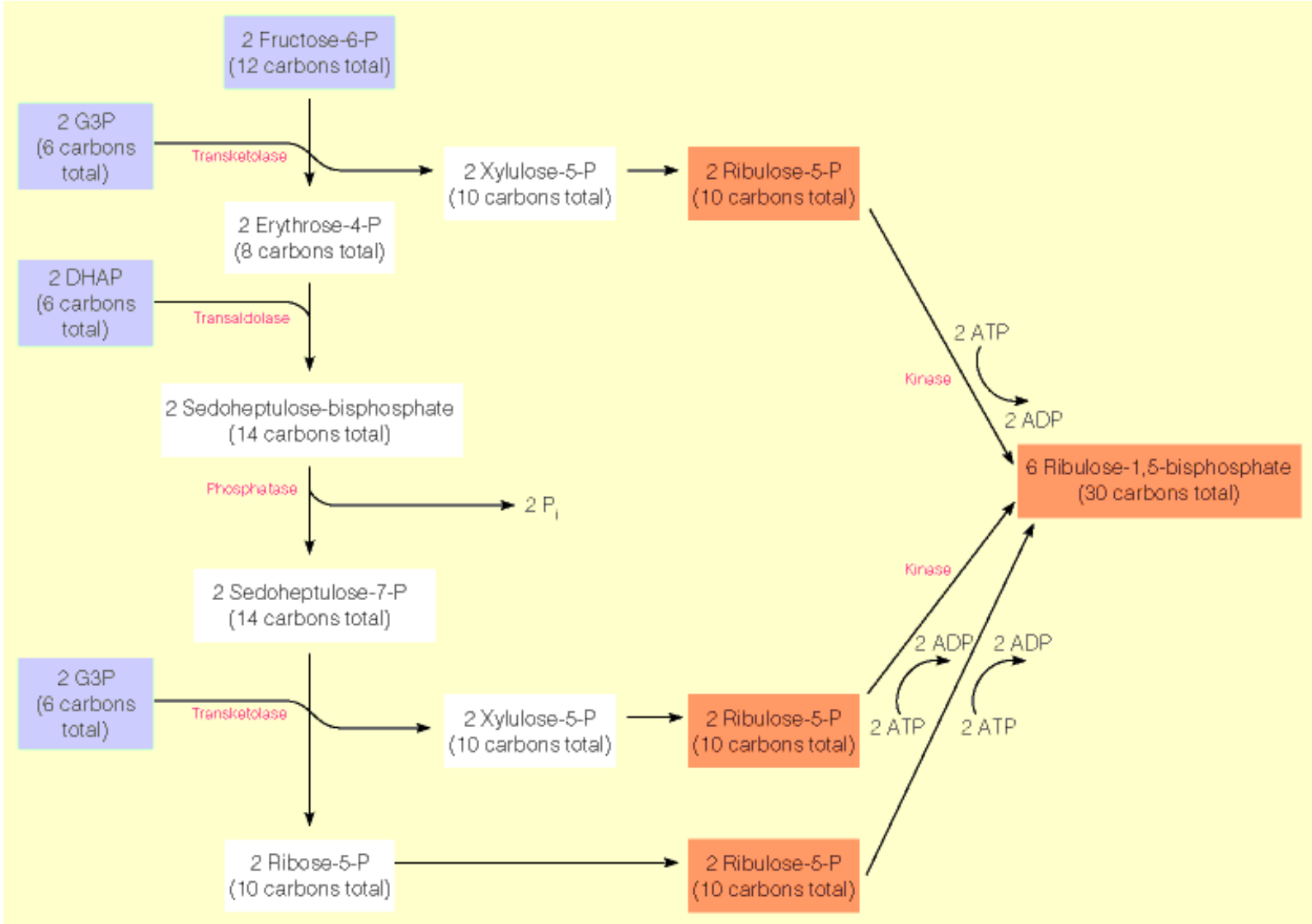

Ribulose-5-Phosphate Kinase

Ribulose-5-Phosphate Kinase is the enzyme that catalyzes the reaction below in the Calvin cycle.



This reaction is one of the few in the Calvin cycle that do not have an equivalent reaction in the pentose phosphate pathway.

See also: [Calvin Cycle](#), [Pentose Phosphate Pathway](#)

INTERNET LINKS:

1. [CO₂ Fixation in Bacteria](#)
 2. [CO₂ Fixation in Plants](#)
-

Nitrogenase Reductase (Component II)

The enzyme system responsible for N₂ reduction, called the nitrogenase complex, consists of two separate proteins. As outlined in [Figure 20.4](#), one protein-called component I, nitrogenase, or molybdenumiron protein-catalyzes the reduction of N₂, and the other-called **component II, nitrogenase reductase**, or **iron protein**-transfers electrons from ferredoxin or flavodoxin to component I. Both component I and component II contain Fe₄S₄ iron-sulfur clusters, and component I also contains molybdenum, in the form of a tightly bound iron-molybdenum cofactor (FeMoCo).

The **component II** in *azotobacter* contains vanadium instead of iron.

See also: [Component I](#), [Metalloenzymes](#), [Nitrogenase](#), [Nitrogen Fixation](#), [Figure 20.2](#), [Ferredoxin](#), [Nitrogen Fixation](#), [Nitrogenase](#)

INTERNET LINK: [Molybdenum Nitrogenase Component II](#)

Figure 20.4: Schematic view of nitrogen fixation.

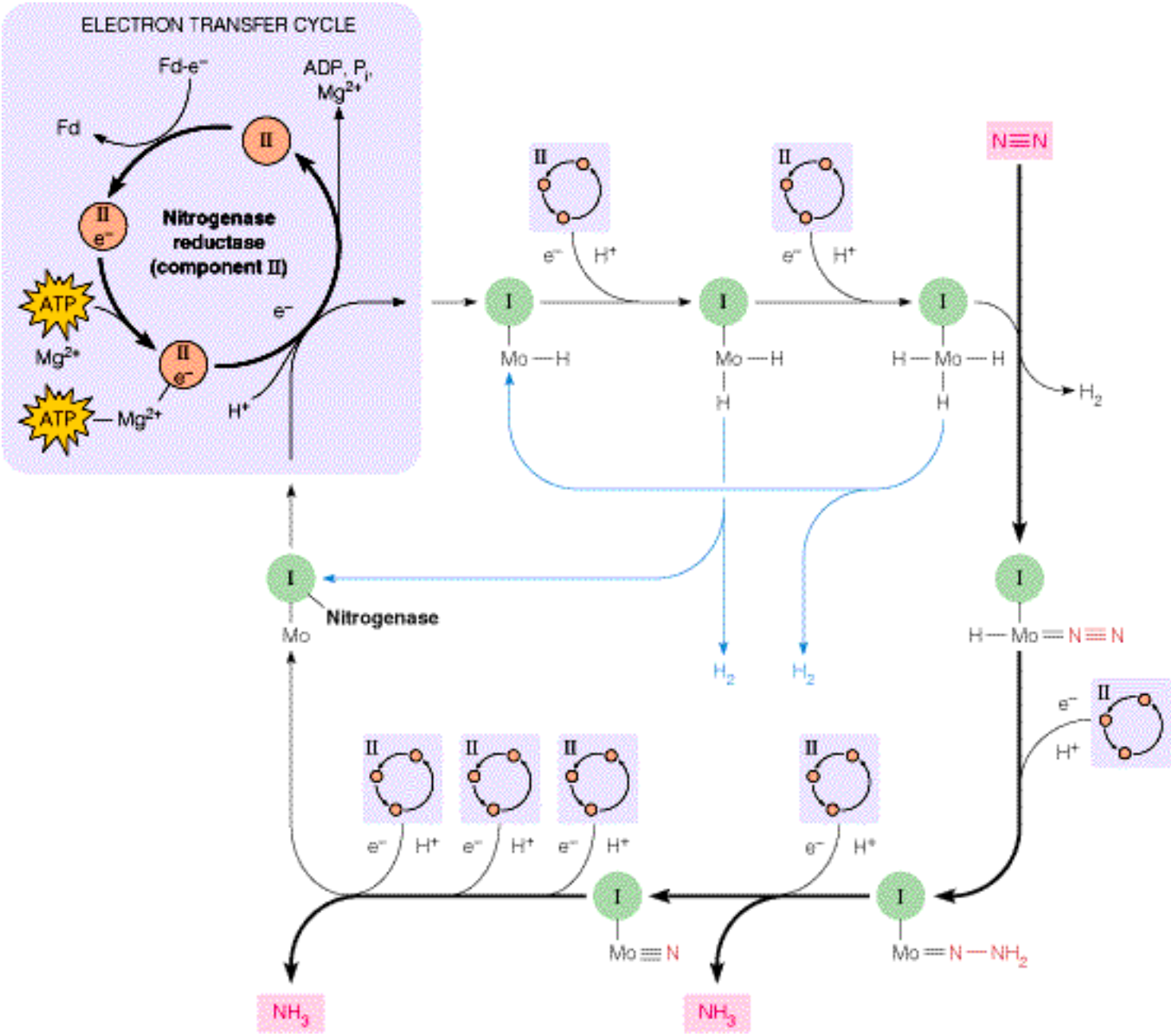

Concepts courtesy of Harold J. Evans.

Nitrogenase (Component I)

The enzyme system responsible for N₂ reduction, called the nitrogenase complex, consists of two separate proteins. As outlined in [Figure 20.4](#), one protein-called component I, nitrogenase, or molybdenumiron protein-catalyzes the reduction of N₂, and the other-called **component II, nitrogenase reductase**, or **iron protein**-transfers electrons from ferredoxin or flavodoxin to component I. Both component I and component II contain Fe₄S₄ iron-sulfur clusters, and component I also contains molybdenum, in the form of a tightly bound iron-molybdenum cofactor (FeMoCo).

See also: [Metalloenzymes](#), [Nitrogenase](#), [Nitrogen Fixation](#), [Figure 20.2](#), [Ferredoxin](#), [Nitrogen Fixation](#), [Nitrogenase Reductase](#)

Metalloenzymes



Metalloenzymes are enzymes that contain a metal, which they use as part of the reaction they catalyze.

See also: [Function of Coenzymes](#), [Nitrogenase Reductase](#) (vanadium-containing in Azotobacter)

INTERNET LINK: [Metalloprotein Database](#)

Function of Coenzymes

Some kinds of biological processes require catalytic functions beyond those built into protein molecules alone. In such cases, a protein may require the help of some other small molecule or ion to carry out the reaction. Molecules bound to enzymes for this purpose are called **coenzymes**. The water soluble vitamin B complexes are metabolic precursors of a number of **coenzymes**. [Table 11.5](#) lists several important coenzymes together with their related vitamins.

NAD⁺ - Nicotinamide adenine dinucleotide (NAD⁺) is derived from the vitamin niacin. The nicotinamide portion of the molecule is capable of being reduced and can thus serve as an oxidizing agent (see [here](#)), where 'R' stands for the remainder of the molecule. **NAD⁺/NADH** behave both like a second substrate in a reaction (because each is converted to the other by the enzyme) and like a coenzyme (because they are recycled over and over). They are generally classified as coenzymes.

Metal Ions in Coenzymes - Many enzymes contain metal ions, usually held by coordinate covalent bonds from amino acid side chains, but sometimes bound by a prosthetic group like heme. Such enzymes are called **metalloenzymes**. [Figure 11.27](#) shows the active site of the protease carboxypeptidase A, which contains a zinc ion.

See also: [Coenzymes](#) (from Chapter 14)

INTERNET LINK: [Metalloprotein Database](#)

Table 11.5



Vitamin	Coenzyme	Reactions Involving These Coenzymes	Page Where Coenzyme Is Introduced
Thiamine (vitamin B ₁)	Thiamine pyrophosphate	Activation and transfer of aldehydes	490
Riboflavin (vitamin B ₂)	Flavin mononucleotide; flavin adenine dinucleotide	Oxidation–reduction	492
Niacin	Nicotinamide adenine dinucleotide; nicotinamide adenine dinucleotide phosphate	Oxidation–reduction	389, 423
Pantothenic acid	Coenzyme A	Acyl group activation and transfer	494
Pyridoxine	Pyridoxal phosphate	Various reactions involving amino acid activation	731
Biotin	Biotin	CO ₂ activation and transfer	507
Lipoic acid	Lipoamide	Acyl group activation; oxidation–reduction	492
Folic acid	Tetrahydrofolate	Activation and transfer of single-carbon functional groups	732
Vitamin B ₁₂	Adenosyl cobalamin; methyl cobalamin	Isomerizations and methyl group transfers	738

Unnumbered Item

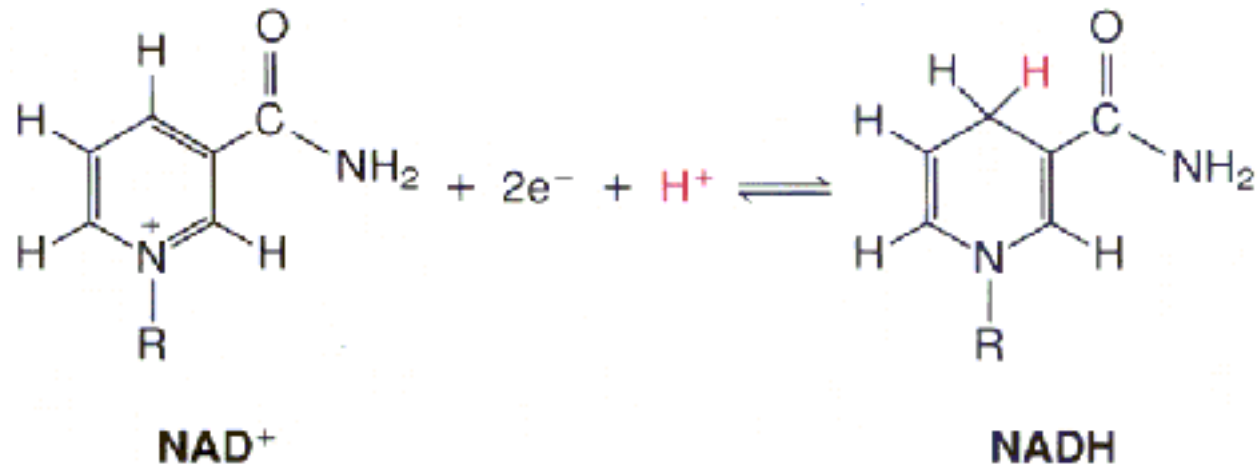
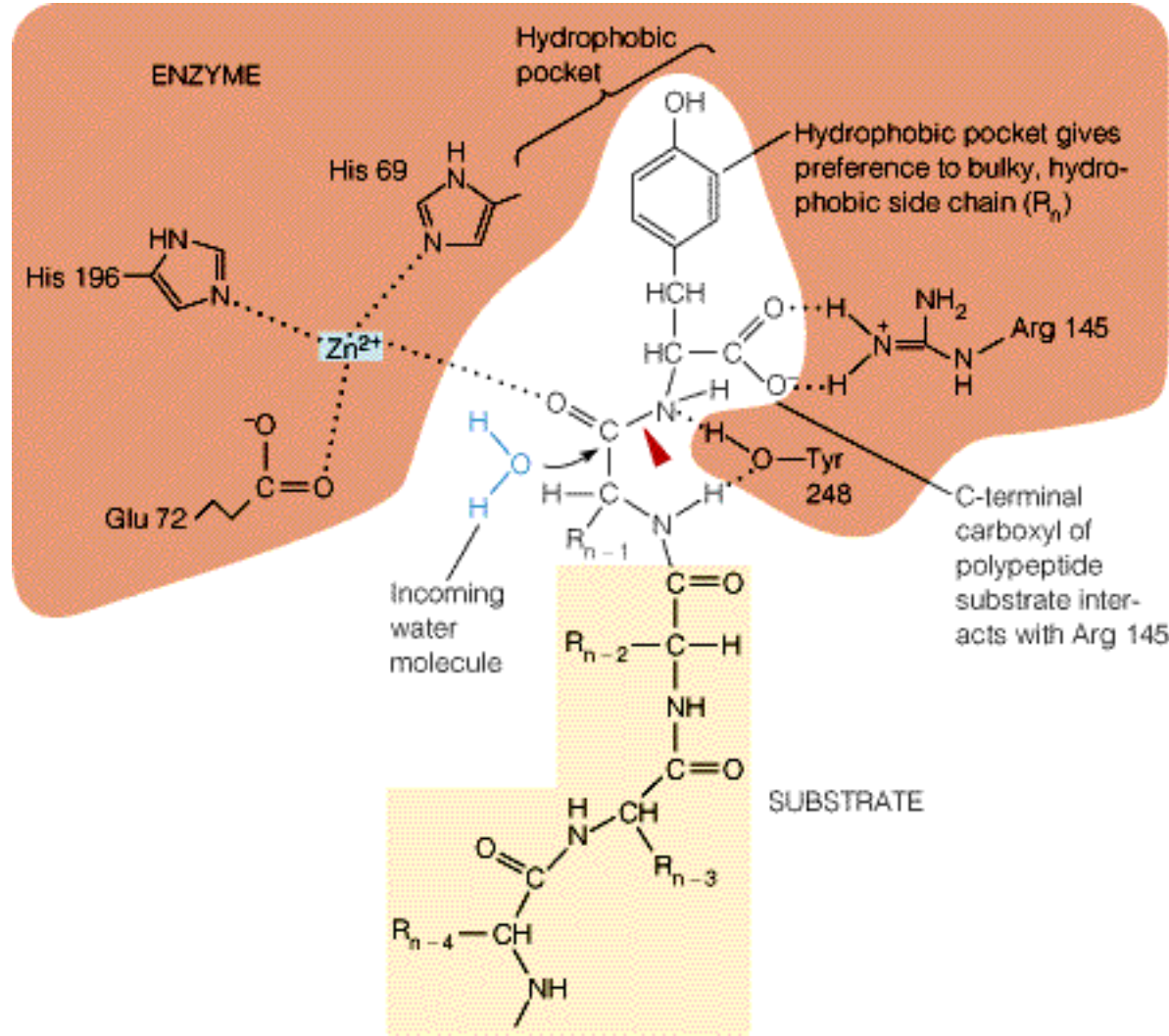

Figure 11.27: Active site of the protease carboxypeptidase A.



Coenzymes

Some enzymes may require the help of some other small molecule or ion to catalyze a reaction. The molecules that are bound to enzymes for this purpose are called **coenzymes**. Like enzymes, **coenzymes** are not irreversibly changed during catalysis; they are either unmodified or regenerated. Each kind of **coenzyme** has a particular chemical function. Some are oxidation/reduction agents, some facilitate group transfers, and so forth. In fact, if we consider electrons as "groups" to transfer, we can categorize all **coenzymes** as being involved in transfer processes. The number of important **coenzymes** is limited, but each of them may be associated with many different enzymes.

Sometimes it is difficult to make a clear distinction between a true **coenzyme** and a second substrate in a reaction. The dehydrogenase enzymes, such as [alcohol dehydrogenase](#), each have a strong binding site for [NAD⁺](#), the oxidized form. After oxidation of the substrate, [NADH](#), the reduced form, leaves the enzyme and is reoxidized by other electron-acceptor systems in the cells. The [NAD⁺](#) so formed can bind to another enzyme molecule and repeat the cycle. In such cases, [NAD⁺](#) acts more like a second substrate than a true coenzyme. Nevertheless, [NAD⁺](#) and [NADH](#) differ from most substrates in that they are continually recycled in the cell and are used over and over again. Because of this behavior, [NAD⁺](#) and [NADH](#) are considered to be **coenzymes**.

[NAD⁺](#) behaves unambiguously as a **coenzyme** in the [UDP-glucose 4-epimerase](#) reaction shown in [Figure 11.26](#). This enzyme facilitates synthesis of complex polysaccharides by interconverting UDP-glucose and UDP-galactose. The mechanism by which the hydroxyl at position 4 is changed in stereochemical orientation involves oxidation of the hydroxyl to a carbonyl as an intermediate state. In this case, [NAD⁺](#) and [NADH](#) never leave the enzyme; they are reduced and reoxidized in a cyclic fashion, providing a temporary resting place for electrons and the hydrogen from the substrate. This reaction provides a good example of what coenzymes do and why they are necessary. The carbonyl intermediate provides an excellent intermediate state for interconversion of the sugars, but none of the normal amino acid side chains of a protein are really well suited to promote this kind of oxidation and reduction. By binding [NAD⁺](#), the enzyme can carry out this function. Examples of reaction types that require different **coenzymes** are included in [Table 11.5](#).

Many of the **coenzymes** are closely related to vitamins, as [Table 11.5](#) shows. In the table, the portion of the **coenzyme** molecule that must be provided in the human diet as a vitamin is identified in blue. Keep in mind, though, that other vitamins (such as [vitamin A](#) for example) play essential physiological roles but are not associated with **coenzymes**.

See also: [FAD](#) / [FADH₂](#), [Thiamine Pyrophosphate](#), [Coenzyme A](#), [Biotin](#), [Vitamin B12](#)

Alcohol Dehydrogenase

Alcohol dehydrogenase is a zinc-containing enzyme that catalyzes the reversible conversion of acetaldehyde and ethanol using NADH / NAD⁺. See below.

Alcoholic fermentation depends on the enzyme to produce ethanol under anaerobic conditions. Production of acetaldehyde by reversal of the reaction by the liver enzyme may be responsible for the "hangover" felt after drinking too much alcohol.

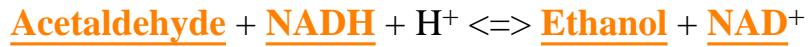

See also: [Lactic Acid fermentation](#), [Alcoholic Fermentation](#)

Ethanol

Ethanol is produced as part of a fermentation process in yeast referred to as anaerobic glycolysis.

Ethanol + NAD⁺ \rightleftharpoons Acetaldehyde + NADH (catalyzed by Alcohol Dehydrogenase)

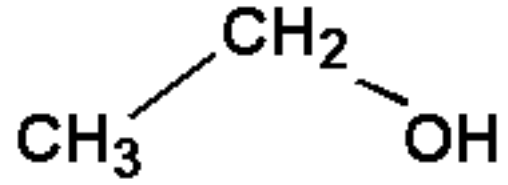

Ethanol

See also: [Alcoholic Fermentation](#), [Alcohol Dehydrogenase](#), [Fermentation](#), [Anaerobic Glycolysis](#), see also [here](#)

Lactate Fermentation

Lactate fermentation occurs in anaerobic organisms or in aerobic cells that are undergoing very high rates of glycolysis. In these cells, **NADH** generated in glycolysis cannot be reoxidized to **NAD⁺**. When this situation happens, NADH is oxidized to NAD⁺ by reducing pyruvate to **lactate**. The enzyme catalyzing this reaction is **lactate dehydrogenase**. The equilibrium for this reaction lies far in favor of formation of **lactate**.

Until recently it was thought that **lactate** accumulation in skeletal muscle was largely a consequence of anaerobic metabolism, which occurs when the need for tissues to generate energy exceeds their capacity to oxidize the pyruvate produced in glycolysis. Recent metabolic studies, including ³¹P NMR analyses of the levels of phosphorylated intermediates in living muscle cells during exercise, suggest that **lactate** is actually an intermediate and not a metabolic "dead end," whose only fate is reconversion to pyruvate. These studies show that even in fully oxygenated muscle tissue, as much as 50% of the glucose metabolized is converted to **lactate**. This may represent a means for coordinating energy-storing and energy-generating pathways in different tissues, but the mechanisms involved are not yet clear.

Lactate dehydrogenase was the first enzyme that established the structural basis for the existence of isoenzymes (different forms of an enzyme resulting from variations in amino acid sequence). Most tissues contain five isoenzymes of lactate dehydrogenase that can be resolved electrophoretically.

See also: [Fermentation](#), [Anaerobic Glycolysis](#), [Glycolysis](#), [Pyruvate](#), [Lactate](#), [Anaerobic Process for Generating Metabolic Energy](#)

Lactate Dehydrogenase

Lactate dehydrogenase (LDH) catalyzes the reaction below. This reaction provides an important source of NAD^+ for cells undergoing anaerobic glycolysis.

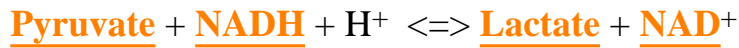

LDH is a tetrameric protein consisting of two types of subunits, called M and H, which have small differences in amino acid sequence. Different molecular forms of an enzyme are called isoenzymes or isozymes. M subunits predominate in skeletal muscle and liver, and H subunits predominate in heart. M and H subunits combine randomly with each other, so that the five major isoenzymes have the compositions M₄, M₃H, M₂H₂, MH₃, and H₄. Because of random subunit reassortment, the isoenzymic composition of a tissue is determined primarily by the activities of the genes specifying the two subunits.

See also: [LDH Isoenzymes](#), [Pyruvate/Lactate/Ethanol Metabolism](#), [Anaerobic Process for Generating Metabolic Energy](#), [Lactic Acid Fermentation](#), [Ethanol Metabolism and Gluconeogenesis](#)

Lactic Acid (Lactate)

In anaerobic organisms or in aerobic cells that are undergoing very high rates of [glycolysis](#), the [NADH](#) generated in glycolysis (in the oxidation of [glyceraldehyde-3-phosphate](#) to [1,3 bisphosphoglycerate](#)) cannot be reoxidized to [NAD⁺](#) in the mitochondrion. When this situation occurs, the cell must find a way to convert NADH to NAD⁺, in order to maintain homeostasis.

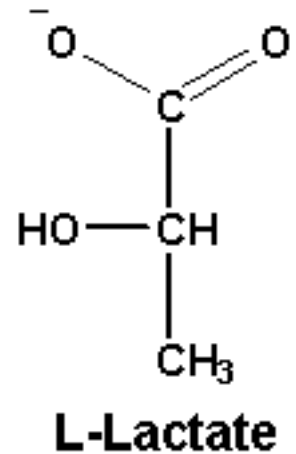

Both in eukaryotic cells and in lactic acid bacteria, the mechanism involves [pyruvate](#) being reduced to [lactate](#). The enzyme catalyzing this reaction is [lactate dehydrogenase](#). The equilibrium for this reaction lies far in favor of formation of [lactate](#).

[Figure 13.6](#), which depicts the energy profile of anaerobic glycolysis, shows that NADH produced in the oxidation of glyceraldehyde-3-phosphate is used to reduce [pyruvate](#) to [lactate](#). Thus, during [anaerobic glycolysis](#) or [lactic acid fermentation](#), an overall electron balance is maintained. (Note - [alcohol fermentation](#) is another type of anaerobic glycolysis).

[Lactate](#) is an important precursor of glucose in the [Cori cycle](#) ([Figure 16.5](#))

See also: [Anaerobic Glycolysis](#), [Lactate Fermentation](#), [Glycolysis](#), [NADH](#), [NAD⁺](#), [Gluconeogenesis Precursors](#)

Figure 13.6: Energy and electron profile of anaerobic glycolysis.

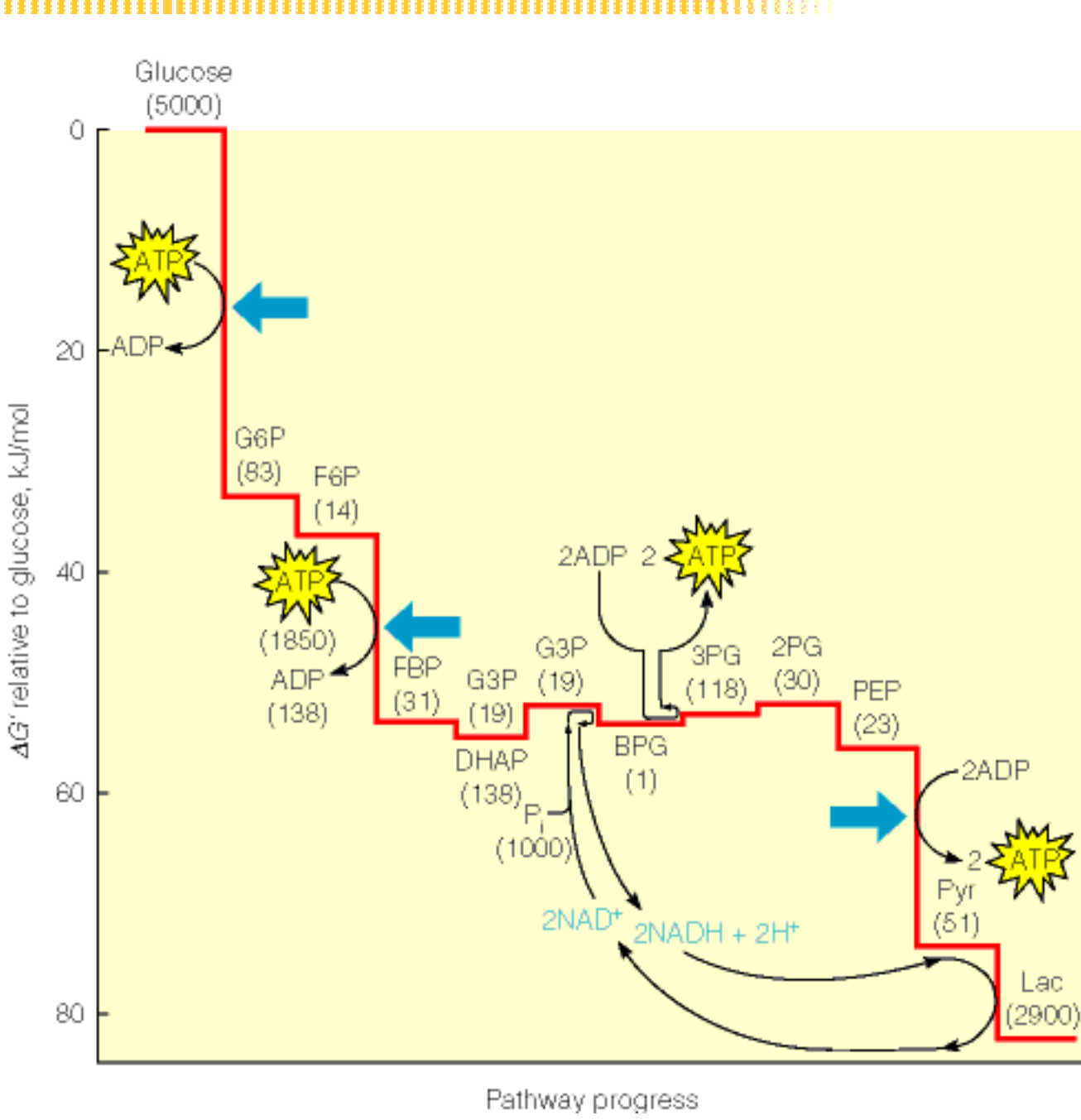

Anaerobic Process of Generating Metabolic Energy

The main focus of Chapter 13 is the catabolism of glucose through glycolysis. Related, though lower - priority concepts include the catabolism of other sugars, polysaccharides, glycerol, and formation of lactate and ethanol.

Key points to remember about **glycolysis**:

1. **Glycolysis** can proceed by mechanisms that are either **anaerobic** (non-oxidative - little or no oxygen present) or **aerobic** (oxidative - oxygen present and electron transport and oxidative phosphorylation are occurring).

2. **Glycolysis** produces **NADH** from **NAD⁺** in Reaction 6 (G3P \rightleftharpoons 1,3BPG). In aerobic glycolysis, NADH is converted to NAD⁺ by the processes of **electron transport** and **oxidative phosphorylation**, which occur in the mitochondria. If oxygen is limiting (such as during heavy exercise), oxidative phosphorylation does not occur and NADH is not converted to NAD⁺. This could be disastrous if there were no other way to produce NAD⁺. Under these circumstances, pyruvate is converted to **lactate** (see **reaction**), yielding NAD⁺

3. **Anaerobic glycolysis** is much less efficient than **aerobic glycolysis**. **Anaerobic glycolysis** produces only 2 net ATPs per molecule of glucose, whereas aerobic glycolysis produces 38 molecules of ATP per molecule of glucose.

4. Regulatory mechanisms for **glycolysis** include

1. Allosteric regulation
2. Hormonal control (via the **kinase cascade**)
3. Substrate level control
4. Covalent modification (phosphorylation via the kinase cascade)

5. Key regulatory enzymes for **glycolysis** include

1. **Hexokinase** (substrate-level regulation by **glucose-6-phosphate**)
2. **Phosphofruktokinase** (allosteric regulation by F2,6BP, **AMP**, **ADP**,

ATP, citrate)

3. Pyruvate kinase (allosteric regulation by ATP, acetyl-CoA, D-fructose-1,6-bisphosphate and covalent modification - namely, phosphorylation)

See also: Oxidative Phosphorylation (from Chapter 15), Regulation of Glycolysis, Fructose-2,6-Bisphosphate Regulation (from Chapter 16), Reactions/Energies of Glycolysis, Lactic Acid fermentation, Pyruvate Decarboxylase, Alcohol Dehydrogenase, Alcoholic Fermentation, Aerobic vs. Anaerobic Glycolysis

Outline



Introduction ([Figure 13.1](#))

Anaerobic Metabolism

Glycolysis Overview ([Figure 13.3](#))

Relation to Other Pathways

Entry Point for Hexose Sugars ([Figure 13.12](#))

Energy Investment/Generation ([Figure 13.2](#))

Anaerobic/Aerobic Glycolysis

Early Atmosphere

Reoxidize NADH to Maintain Steady State

Fermentation (no net change in oxidation state) = Anaerobic Glycolysis

Pyruvate/Lactate

Alcohol DH

Respiration (oxidative breakdown and energy release by reaction with oxygen)

Respiration Using Oxygen = Aerobic Glycolysis

Crucial Early Experiments

Buchners - 1897 - Cell Free fermentation

Harden/Young - 1905 Phosphate Stimulates fermentation of glucose

Embden/Meyerhof/Warburg - 1930s - Reactions of glycolysis

Strategy of Glycolysis

Glycolysis occurs in cytosol

Overview ([Figure 13.3](#))

1,3BPG and PEP energy of hydrolysis ([Figure 3.7](#))

Types of phosphorylation

Substrate-level (Glycolysis)

Oxidative phosphorylation (Driven by electron transport)

Photophosphorylation (Photosynthesis)

Reactions of Glycolysis

Energy Investment (Figure)

Reaction 1 - Structures / Enzyme / Summary

Reaction 2 - Structures / Enzyme / Summary

Reaction 3 - Structures / Enzyme / Summary

Reaction 4 - Structures / Enzyme / Summary (Figure 13.4)

Reaction 5 - Structures / Enzyme / Summary

Energy Generation (Figure on page 454)

Reaction 6 - Structures / Enzyme / Summary (Figure 13.5)

Reaction 7 - Structures / Enzyme / Summary

Reaction 8 - Structures / Enzyme / Summary

Reaction 9 - Structures / Enzyme / Summary

Reaction 10 - Structures / Enzyme / Summary

Overall Summary (Table 13.1)

Metabolic Fates of Pyruvate (Pyruvate/Lactate/Ethanol Metabolism)

Lactate Metabolism

Lactate Dehydrogenase Reaction

Isoenzymes of Lactate Dehydrogenase

Ethanol Metabolism

Pyruvate decarboxylase / Alcohol dehydrogenase (Figure)

Thiamine pyrophosphate requirement

Energy And Electron Balance Sheets ([Figure 13.6](#))

ATP Energy Summaries of Glycolysis

Glucose -> 2 Lactate (lactic acid fermentation)

Glucose -> 2 Ethanol (alcoholic fermentation)

Glucose -> 2 Pyruvate (aerobic subtotal)

2 NADH -> 6 ATP (aerobic conversion)

Glucose -> 2 Pyruvate overall (oxidative)

Metabolism to lactate or ethanol non-oxidative

More ATPs from Citric Acid Cycle (38 total)

Regulation of Glycolysis

The Pasteur Effect

Inhibition of glycolysis by oxygen

Intermediates after F6P decrease with O₂

Oscillations of Glycolytic Intermediates

Activity of glycolysis depends on adenylate energy charge ([Figure 13.8](#))

Allosteric Regulation of Phosphofructokinase

PFK Activator = Fructose-2,6-bisphosphate ([Figure 13.9](#))

PFK-2

Phosphorylation/dephosphorylation - [Figure 16.7](#)

Other PFK Activators = AMP, ADP

PFK Inhibitors = ATP and Citrate

PFK is the enzyme through which adenylate energy charge is controlled

Control of Pyruvate Kinase

Inhibitors = ATP and Acetyl CoA
Feedforward Activation by F1,6BP

Glycolysis as Both a Catabolic and an Anabolic Pathway

(Relationship of Glycolysis to Other Metabolic Pathways)

Biosynthetic intermediates from glycolysis (Figure 13.10)
Regulatory relationships with other pathways (Figure 13.11)

Entry of Other Sugars into the Glycolytic Pathway

Catabolism of Other Saccharides

Monosaccharide Metabolism (Figure 13.12)

Galactose Utilization (Summary)

Derived from Lactose
Conversion to glucose-6-phosphate (Figure 13.13)

Galactose-1-phosphate formation by galactokinase
UDP-galactose formation (UDP-Glc:GalP uridylyl transferase)
UDP-glucose formation (UDP-galactose 4-epimerase)
(Figure 13.14)
Galactose-1-phosphate release (UDP-Glc:GalP uridylyl transferase)
Conversion to glucose-6-phosphate (phosphoglucomutase)

Lactose synthesis in milk

Lactose synthase

Galactosemia

Fructose Utilization

Fructose-6-phosphate (from hexokinase)

Fructose-1-phosphate (from fructokinase then cleavage by aldolase B)

Mannose Utilization

Mannose-6-phosphate formation (catalyzed by hexokinase)

Conversion of mannose-6-phosphate to fructose-6-phosphate

Disaccharide Metabolism (See Figure)

Maltose -> 2 Glucose (catalyzed by maltase)

Lactose -> Galactose + Glucose (catalyzed by lactase)

Sucrose -> Fructose + Glucose (catalyzed by sucrase)

Lactose intolerance

Bacterial sucrose enzyme (sucrose phosphorylase)

Glycerol Metabolism

From fat digestion

Glycerol kinase (glycerol -> glycerol-3-phosphate)

Glycerol-3-phosphate dehydrogenase (glycerol-3-phosphate -> DHAP)

Catabolism of Polysaccharides

Hydrolytic and Phosphorolytic Cleavages (Figure 13.15)

Phosphorylase vs. phosphatase

Energy considerations

Starch and Glycogen Digestion

α -Amylase (Figure 13.16)

In saliva

Cleaves internal α (1,4) linkages of starch and glycogen

Limit Dextrin

Glycogen Mobilization (Glycogen Breakdown)

Glycogen phosphorylase

Starch phosphorylase

Debranching activity (Figure 13.17)

Conversion of glucose-1-phosphate to glucose-6-phosphate

Phosphoglucomutase

Regulation of Glycogen Breakdown (Figure 13.18)

Structure of glycogen phosphorylase

Phosphorylation by phosphorylase b kinase (Calmodulin effects)

Dephosphorylation by phosphorylase phosphatase

Control of Phosphorylase Activity

Phosphorylase b kinase activation by cAMP-dependent protein kinase

Reciprocal effect on glycogen synthesis

Role of epinephrine

Kinase cascade

Proteins in the Glycogenolytic Cascade

Adenylate cyclase

cAMP-dependent protein kinase

Phosphorylase b kinase
Calmodulin (Figure 13.20)
Glycogen phosphorylase

Nonhormonal Control of Glycogenolysis

Activation of glycogen phosphorylase b by AMP

Figure 13.1: Anaerobic processes in the generation of metabolic energy.

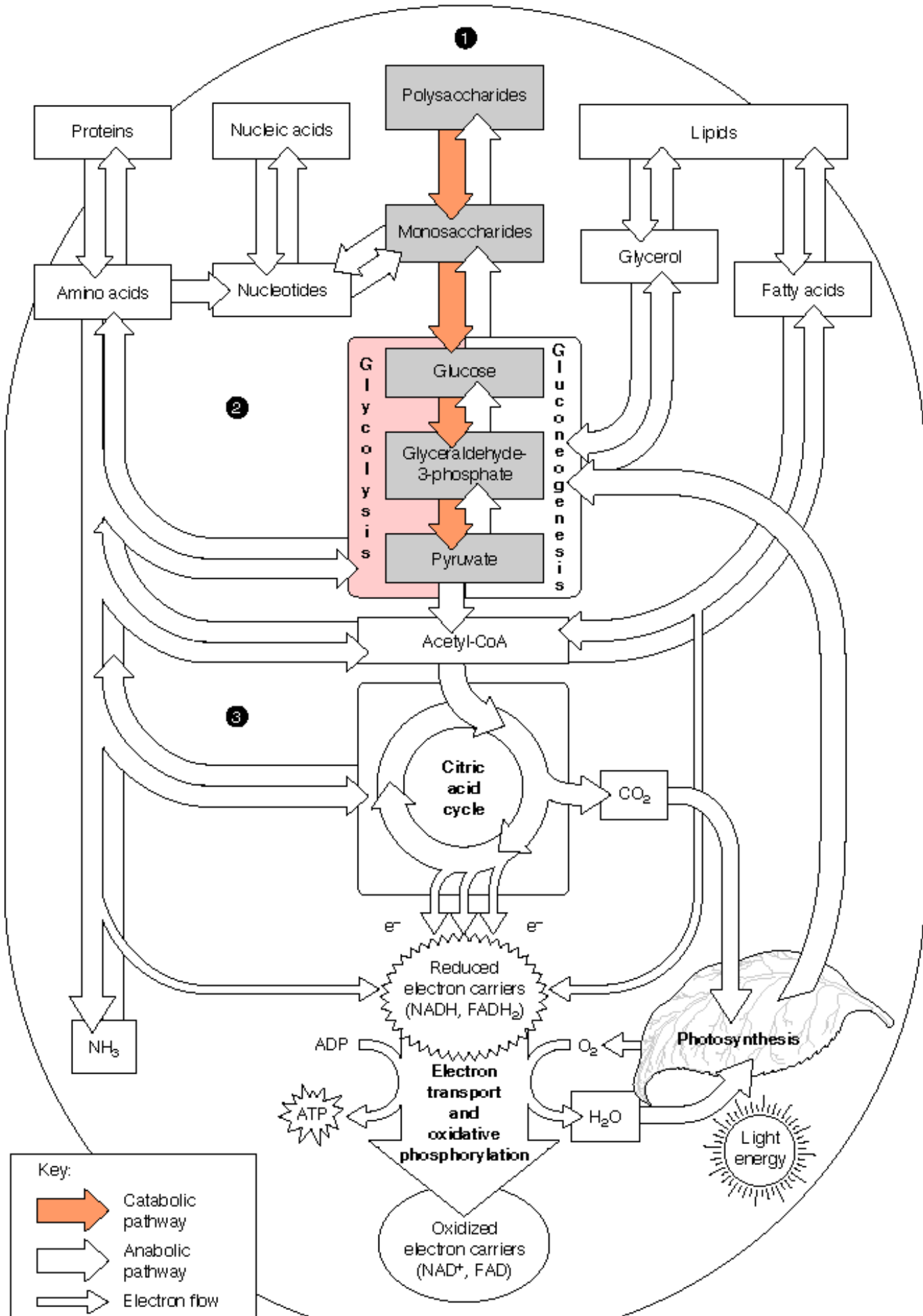



Anabolic pathway



Electron flow

electron carriers
(NAD⁺, FAD)

Figure 13.2: The two phases of glycolysis and the products of glycolysis.

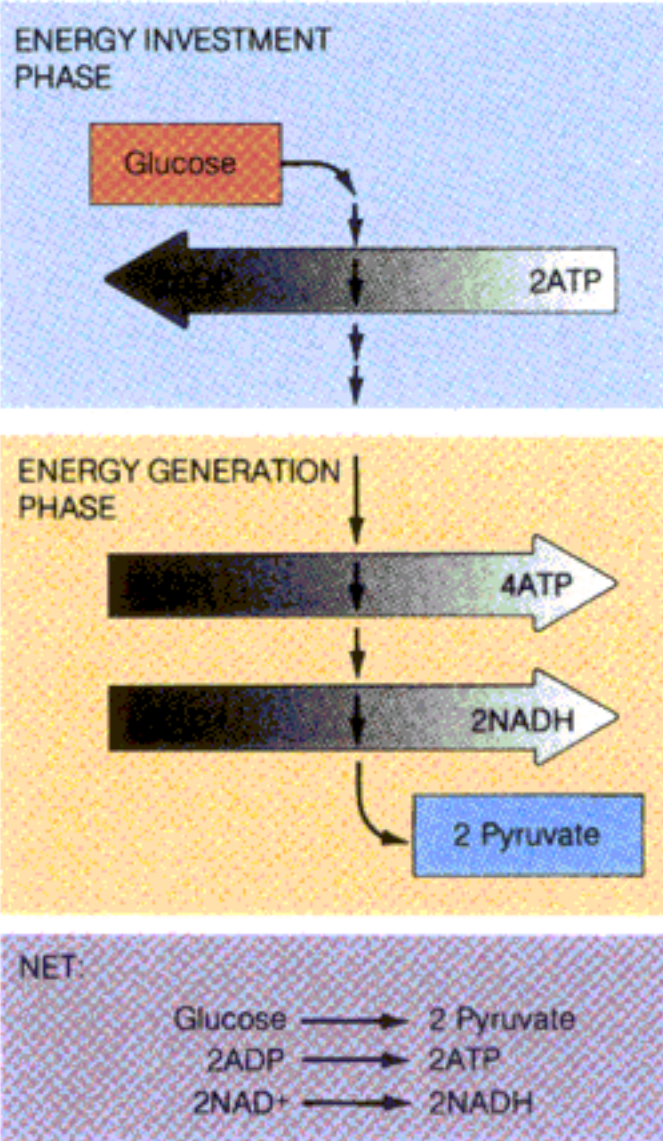

NAD⁺/NADH Balance

The **NAD⁺/NADH** balance of a cell is critical. Cells require sufficient quantities of **NAD⁺** to accept electrons produced in oxidative reactions. In the absence of **NAD⁺**, oxidative reactions in the cell can be completely halted. Since oxidation is the primary source of cellular energy for most non-plant species, the lack of **NAD⁺** can have dire consequences for cells.

Reaction #6 in glycolysis requires **NAD⁺**. Lack of this substrate can bring glycolysis to a halt.

When the **electron transport** system (ETS) and **oxidative phosphorylation** (OxPhos) are operating, **NADH** is recycled back to **NAD⁺** when **NADH** dumps electrons into the electron transport system (**Figure 13.1**).

If OxPhos is stopped for some reason (e.g., under heavy exercise the blood is unable to deliver oxygen fast enough to keep OxPhos occurring), then ETS stops and **NADH** cannot be recycled at the mitochondrion.

Without an alternative means of recycling **NADH** to **NAD⁺**, the cell would not be able to generate ATP from glycolysis and would die.

To avoid this scenario, fermentation may occur.

Fermentation is a non-oxidative process because the product(s) of fermentation are in the same oxidative state as the starting materials.

For example, in lactate fermentation (animal cells), pyruvate is converted to lactate using the electrons of **NADH**, forming **NAD⁺**. **Lactate** is in the same oxidative state as glucose, the starting material of glycolysis. Yeast go through ethanolic fermentation for the same reason with the same result.

See also: [Anaerobic Glycolysis](#), [Pyruvate/Lactate/Ethanol Metabolism](#), [Reactions/Energies of Glycolysis](#)

Pyruvate/Lactate/Ethanol Metabolism

Pyruvate is typically considered the last molecule produced in **glycolysis**. Under aerobic conditions pyruvate is transformed into **acetyl-CoA**, which then enters the **citric acid cycle**. Under anaerobic conditions, however, something else must be done to oxidize all the NADH formed in glycolysis.

1. In animal cells and lactic acid bacteria, pyruvate is converted to lactate. In this case, NADH adds electrons to pyruvate, forming NAD^+ and lactate. The NAD^+ can then catalyze reaction 6 of further glycolysis reactions. Lactate appears to be produced under aerobic cellular conditions as well, however, so the role of lactate formation is not completely clear.

2. Yeasts recycle NADH to NAD^+ by alcoholic fermentation:

Pyruvate \rightarrow acetaldehyde \rightarrow ethanol. The last step converts NADH to NAD^+ .

The reduction of **acetaldehyde** to **ethanol** is coupled to the oxidation of **NADH** to **NAD⁺**.

See also: [Lactate](#), [Lactate Dehydrogenase](#)

Strategy of Glycolysis

Strategy of glycolysis

1. The process of **glycolysis** requires ATP energy input before ATP and NADH energy can be released. This breaks **glycolysis** into two phases - an energy input phase (reactions 1-5) and an energy release phase (reactions 6-10). The energy input phase includes two reactions (**hexokinase** and **phosphofruktokinase**), each where ATP is used. These two steps are bypassed in gluconeogenesis by different enzymes which simply hydrolyze the phosphate group added by phosphorylation in **glycolysis**. The third place where **glycolysis** and gluconeogenesis differ is the pyruvate kinase step (the last reaction in glycolysis). This step is bypassed in gluconeogenesis because it is highly unfavorable energetically.

2. **Glycolysis**, through the formation of **pyruvate**, includes a single oxidation step:

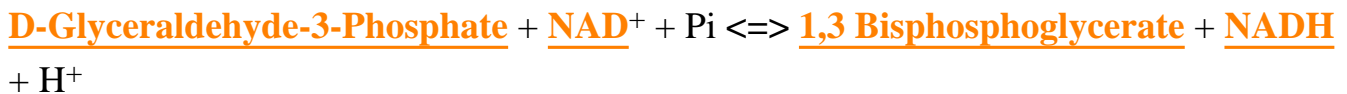

Because there are two molecules of G3P per molecule of **glucose**, there is a total of two molecules of NADH formed per molecule of **glucose**.

3. **1,3BPG** and **PEP** are phosphorylated compounds, each with a phosphoryl group that has a free energy higher than that of the phosphate on ADP. Thus 1,3BPG and PEP can transfer a phosphoryl group to **ADP** to form **ATP**. This is called **substrate level phosphorylation** and it yields four molecules of ATP per molecule of glucose in the energy releasing phase of glycolysis. Thus, the 10 reactions of **glycolysis** generate two net molecules of ATP per molecule of glucose.

See also: [Reactions/Energies of Glycolysis](#), [Regulation of Glycolysis](#), [Hexokinase](#)

Regulation of Glycolysis

Regulatory mechanisms controlling glycolysis include allosteric and covalent modification mechanisms.

Glycolysis is **regulated** reciprocally from **gluconeogenesis**. Molecules, such as **F2,6BP**, that turn on **glycolysis**, turn off gluconeogenesis. Conversely, **acetyl-CoA** turns on gluconeogenesis, but turns off **glycolysis**. See **Figure 16.6**

The principle enzymes of **glycolysis** involved in regulation are hexokinase (reaction 1), phosphofructokinase (reaction 3), and pyruvate kinase (reaction 10):

1. **Hexokinase** is allosterically inhibited by glucose-6-phosphate (**G6P**). That is, the enzyme for the first reaction of glycolysis is inhibited by the product of the first reaction. As a result, glucose and **ATP** (in reactions 1 and 3) are not committed to glycolysis unless necessary.
2. **Phosphofructokinase** (PFK) is a major control point for glycolysis. PFK is allosterically inhibited by ATP and citrate, allosterically activated by **AMP**, **ADP**, and F2,6BP. Thus, carbon movement through glycolysis is inhibited at PFK when the cell contains ample stores of ATP and oxidizable substrates. Additionally, PFK is activated by AMP and ADP because they indicate low levels of ATP in the cell. F2,6BP is the major activator, though, because it reciprocally inhibits **fructose 1,6 bisphosphatase**, which is the gluconeogenic enzyme that catalyzes the reversal of this step.
3. **Pyruvate kinase** is allosterically inhibited by acetyl-CoA, ATP, and **Alanine**; allosterically activated by **F1,6BP**, and inhibited by cAMP-dependent phosphorylation.

Note that several of the allosteric regulators are products of other metabolic pathways or are made in other metabolic pathways. These include acetyl-CoA, AMP, F2,6BP, and G1P, (readily converted into G6P). By having regulation dependent on other pathways, glycolysis is coordinately controlled with these pathways as well.

See also: **[Gluconeogenesis and Glycolysis Interregulation Link Page](#)**, **[Hexokinase](#)**, **[G6P](#)**, **[AMP](#)**,

Pyruvate Kinase Isoenzyme Regulation

Two **isozyme** forms of **pyruvate kinase** exist.

In liver and in other gluconeogenic tissues, the so-called **L form** of pyruvate kinase predominates, whereas the **M form** is found largely in muscle. The **L form** is inhibited both by ATP and by some amino acids, particularly **alanine**, the major gluconeogenic precursor among the amino acids.

This relationship allows inhibition of glycolysis, with consequent activation of gluconeogenesis, specifically in gluconeogenic tissues, when ample energy and substrates are available. Control at the pyruvate kinase step allows conservation of high-energy phosphate in the phosphoenolpyruvate molecule.

See also: [Gluconeogenesis](#), [Glycolysis](#), [Phosphoenolpyruvate](#)

Unnumbered Item

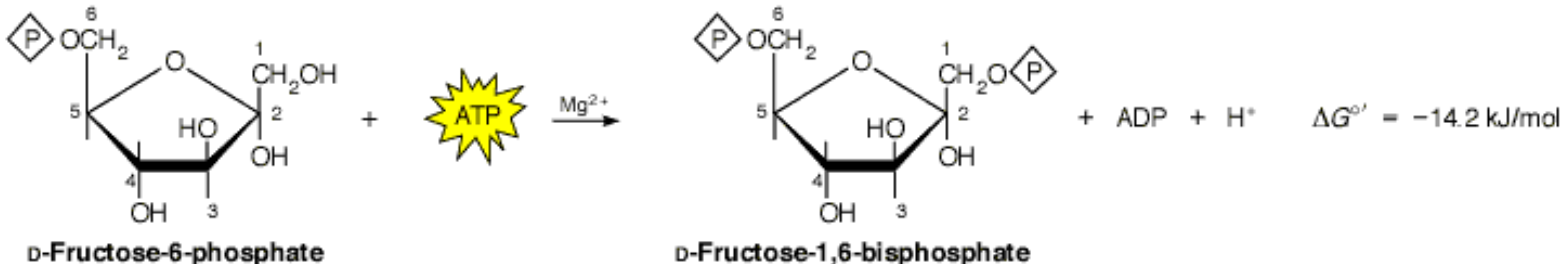

Unnumbered Item

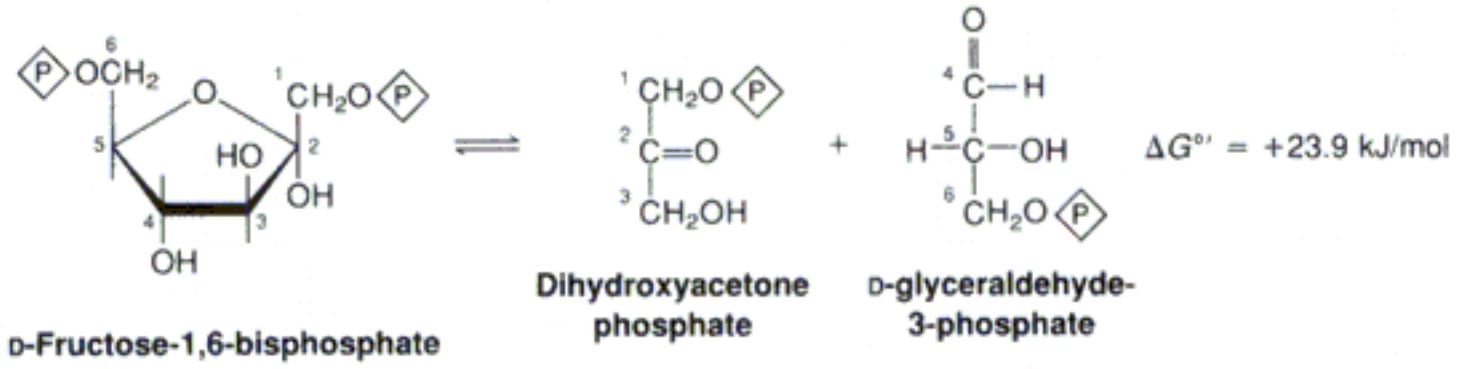
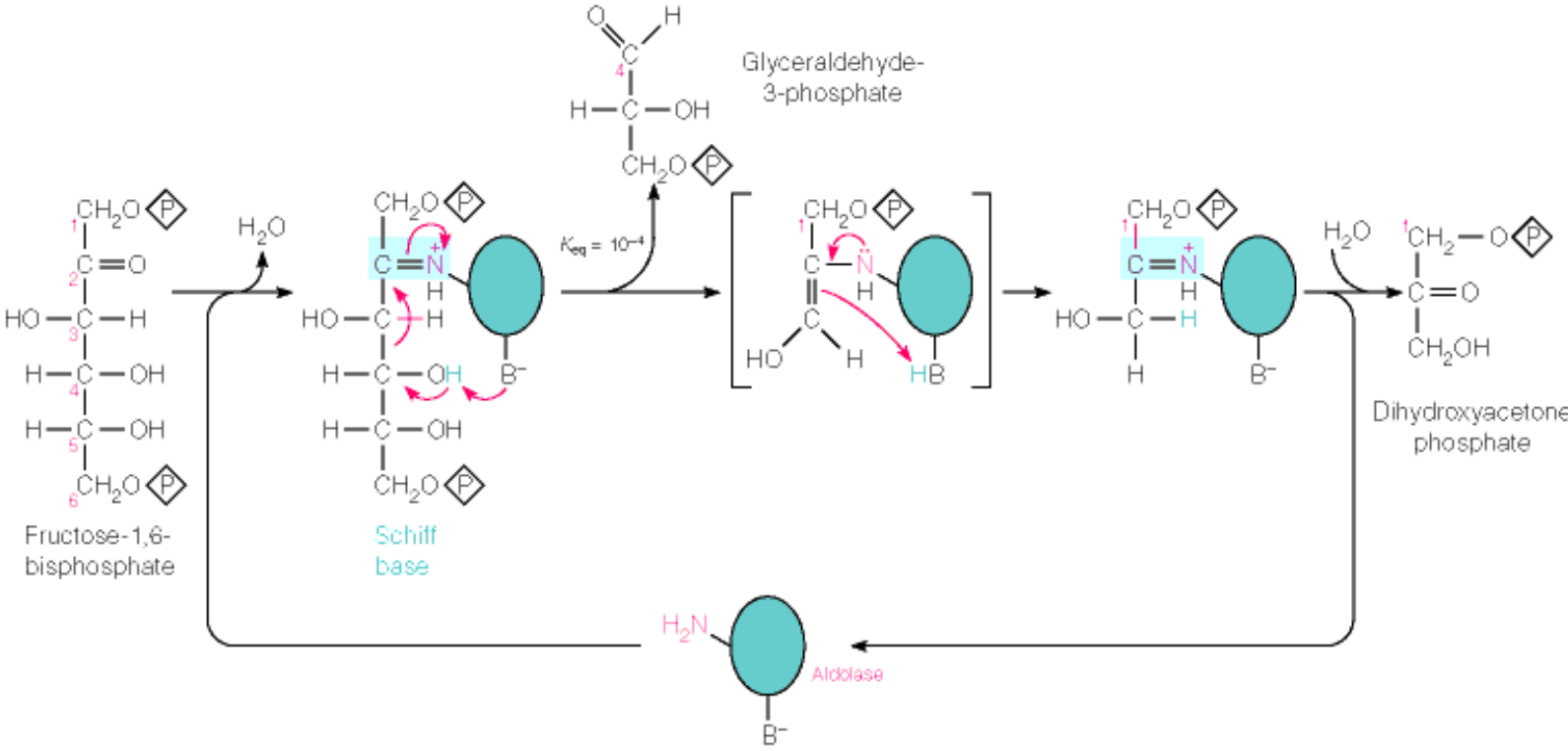

Figure 13.4: Reaction mechanism for fructose-1,6-bisphosphate aldolase.



Unnumbered Item

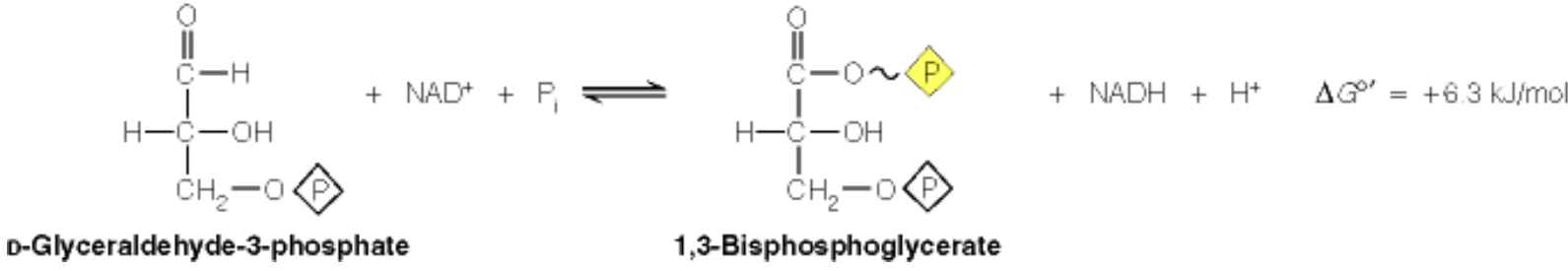
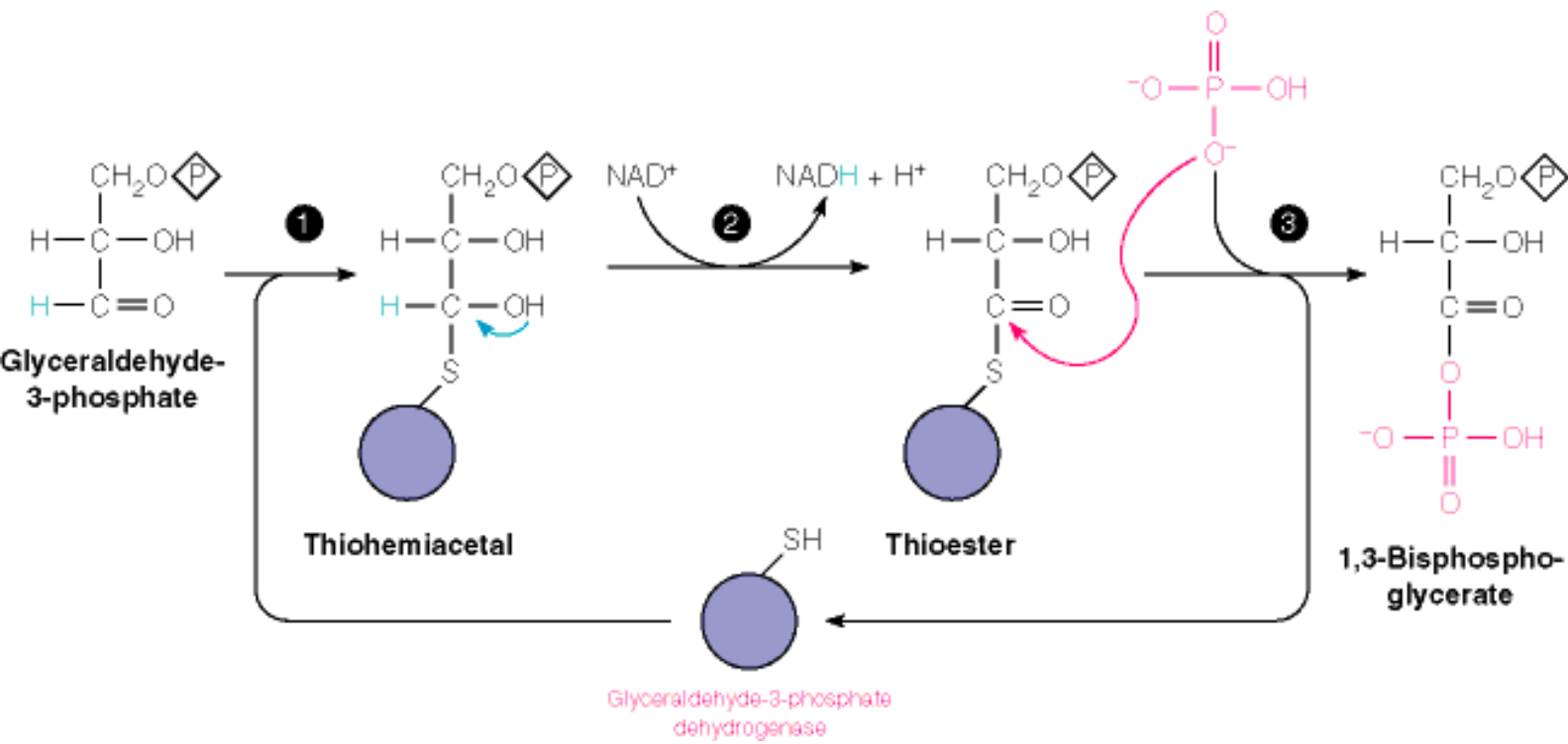

Figure 13.5: Reaction pathway for glyceraldehyde-3-phosphate dehydrogenase.



Unnumbered Item

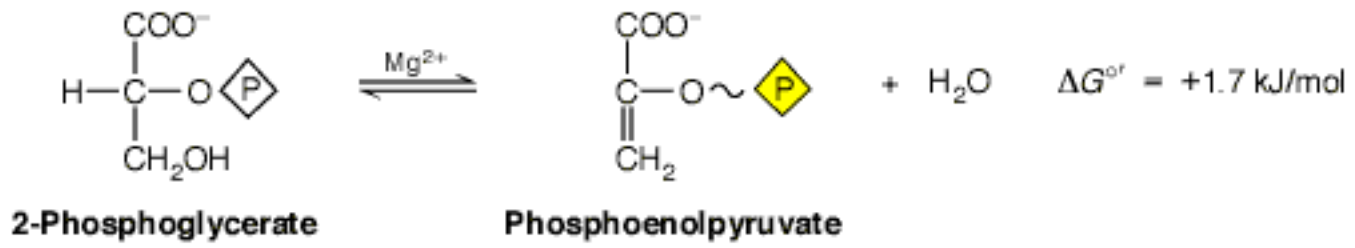
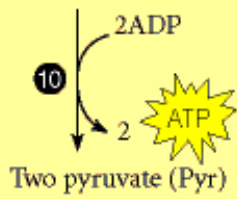

Table 13.1



Reaction	Enzyme	ATP Yield	$\Delta G^{o'}$ (kJ/mol)	ΔG (kJ/mol)
ENERGY INVESTMENT PHASE				
<p>Glucose (G)</p> <p>1</p> <p>Hexokinase (HK)</p> <p>Glucose-6-phosphate (G6P)</p>	Hexokinase (HK)	-1	-16.7	-33.5
<p>2</p> <p>Phosphoglucoisomerase (PGI)</p> <p>Fructose-6-phosphate (F6P)</p>	Phosphoglucoisomerase (PGI)		+1.7	-2.5
<p>3</p> <p>Phosphofructokinase (PFK)</p> <p>Fructose-1,6-bisphosphate (FBP)</p>	Phosphofructokinase (PFK)	-1	-14.2	-22.2
<p>4</p> <p>Aldolase (ALD)</p> <p>Glyceraldehyde-3-phosphate (G3P) + dihydroxyacetone phosphate (DHAP)</p>	Aldolase (ALD)		+23.9	-1.3
<p>5</p> <p>Triose phosphate isomerase (TPI)</p> <p>Two glyceraldehyde-3-phosphate</p>	Triose phosphate isomerase (TPI)		+7.6	+2.5
ENERGY GENERATION PHASE				
<p>6</p> <p>Glyceraldehyde-3-phosphate dehydrogenase (G3PDH)</p> <p>Two 1,3-bisphosphoglycerate (BPG)</p>	Glyceraldehyde-3-phosphate dehydrogenase (G3PDH)		+12.6	-3.4
<p>7</p> <p>Phosphoglycerate kinase (PGK)</p> <p>Two 3-phosphoglycerate (3PG)</p>	Phosphoglycerate kinase (PGK)	+2	-37.6	+2.6
<p>8</p> <p>Phosphoglycerate mutase (PGM)</p> <p>Two 2-phosphoglycerate (2PG)</p>	Phosphoglycerate mutase (PGM)		+8.8	+1.6
<p>9</p> <p>Enolase (ENO)</p> <p>Two phosphoenolpyruvate (PEP)</p>	Enolase (ENO)		+3.4	-6.6
<p>10</p> <p>Pyruvate kinase (PK)</p> <p>Pyruvate</p>	Pyruvate kinase (PK)	+2	-62.8	-33.4

two phosphoenolpyruvate (PEP)



Pyruvate kinase (PK)

+2

-62.8

-33.4

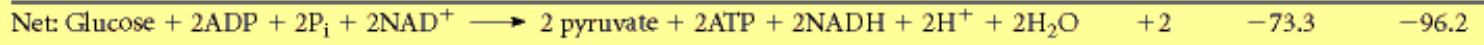

Note: ΔG values are estimated from the approximate intracellular concentrations of glycolytic intermediates in rabbit skeletal muscle. All ΔG values past reaction 5 are doubled, because each reaction involves 2 three-carbon substrates per glucose molecule.

Lactate Dehydrogenase Isozymes

Lactate dehydrogenase (LDH) is a tetrameric protein consisting of two types of subunits, called M and H, which have small differences in amino acid sequence. Different molecular forms of an enzyme are called isoenzymes or isozymes.

The tissue specificity of isoenzyme patterns of **LDH** is useful in clinical medicine. Such pathological conditions as myocardial infarction, infectious hepatitis, and muscle diseases involve cell death of affected tissue, with release of cell contents to the blood. The pattern of **LDH isoenzymes** in the blood serum is representative of the tissue that released the isoenzymes. This information can be used to diagnose such conditions and to monitor the progress of treatment.

See also: [Lactate Dehydrogenase](#)

Pyruvate Dehydrogenase

Pyruvate produced by glycolysis must be oxidized to acetate prior to entry into the citric acid cycle. The enzyme catalyzing this reaction is the **pyruvate dehydrogenase complex**. The overall reaction:

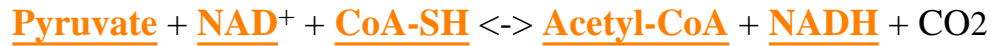

is very energetically favorable ($\Delta G^{\circ\prime} = -33.5 \text{ kJ/mol}$) and is essentially irreversible *in vivo*. The reaction is somewhat involved. Catalysis of the reaction by the **pyruvate dehydrogenase complex** involves three enzymatic activities (below) and five coenzymes (CoA-SH, NADH, **thiamine pyrophosphate**, **FAD**, lipoic acid). The **pyruvate dehydrogenase complex** is a highly organized multienzyme assembly.

Enzymatic activities contained in the **pyruvate dehydrogenase complex** include:

Pyruvate decarboxylase (E1)

Dihydrolipoamide transacetylase (E2)

Dihydrolipoamide dehydrogenase (E3)

See also: [Pyruvate Dehydrogenase Complex](#), [Glycolysis](#), [Thiamine Pyrophosphate](#), [Pyruvate Decarboxylase](#)

Alcoholic Fermentation

Under anaerobic conditions, NADH produced in glycolysis builds up. This results in a reduction in the amount of NAD⁺ available to support continuation of glycolysis. Organisms have two pathways for regenerating NAD⁺ under anaerobic conditions. Animal cells and lactic acid bacteria use the process of [lactic acid fermentation](#). Yeast convert pyruvate to [acetaldehyde](#) in a reaction catalyzed by the enzyme [pyruvate decarboxylase](#). This is followed by reduction of acetaldehyde to [ethanol](#) catalyzed by [alcohol dehydrogenase](#). The reaction uses NADH and releases NAD⁺, which is subsequently used in [glycolysis](#).

See also: [Fermentation](#), [Pyruvate Decarboxylase](#), [NADH](#), [NAD⁺](#), [Anaerobic Processes](#)

Fermentation

Fermentation is defined as an energy-yielding metabolic pathway that involves no net change in oxidation state. Anaerobic glycolysis is a type of fermentation. The **lactic acid fermentation** (conversion of **glucose** to **lactate**) is important in the manufacture of cheese. Another important **fermentation** involves cleavage of **pyruvate** to **acetaldehyde** and CO₂, with the acetaldehyde then reduced to ethanol by **alcohol dehydrogenase** in the reaction that follows:

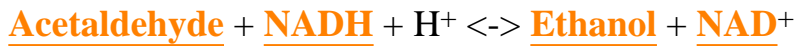

As carried out by yeasts, this **fermentation** generates the alcohol in alcoholic beverages. (see also - **alcoholic fermentation**) Yeasts used in baking also carry out the alcoholic **fermentation**; the CO₂ produced by pyruvate decarboxylation causes bread to rise, and the ethanol produced evaporates during baking. Among the dozens of other useful **fermentations** are those leading to acetic acid (manufacture of vinegar) and propionic acid (manufacture of Swiss cheese).

See also: **Anaerobic Glycolysis**

Aerobic vs Anaerobic Glycolysis

During **aerobic glycolysis**, NADH produced by oxidation of glyceraldehyde-3-phosphate, is oxidized by the mitochondrial electron transport chain, with the electrons transferred ultimately to oxygen. This oxidation of NADH, considered in detail in Chapter 15 (see [here](#)), yields additional energy, with about 3 moles of ATP synthesized from ADP per mole of NADH oxidized. Since 2 moles of NADH are produced per mole of glucose entering the pathway, aerobic glycolysis yields considerably more ATP than anaerobic glycolysis.

In **anaerobic glycolysis**, electrons from NADH do not enter the electron transport chain (see [here](#)). **Anaerobic glycolysis** pathways include lactate fermentation and ethanol fermentation.

Metabolism of glucose to either lactate or ethanol represents a nonoxidative process, as you can see by comparing the empirical formulas for glucose ($C_6H_{12}O_6$) and lactate ($C_3H_6O_3$). Clearly, there is no change in the overall oxidation state of the carbons, because the numbers of hydrogens and oxygens bound per carbon atom are identical for glucose and lactate. The same is true for ethanol plus CO_2 , when one counts the atoms in both. However, some individual carbon atoms of lactate and ethanol plus CO_2 undergo oxidation, and some become reduced.

See also: [Oxidative Phosphorylation](#), [Lactate Fermentation](#), [Ethanol fermentation](#), [NADH](#), [Lactate](#), [Ethanol](#)

Free Energy Changes from Oxidation/Reduction

Standard reduction potentials are directly related to **free energy** changes by the equation

$$\Delta G^{\circ} = -nF \Delta E^{\circ} = -nF [E^{\circ}(\text{acceptor}) - E^{\circ}(\text{donor})] \quad (15.1)$$

where n is the number of electrons transferred in the half-reactions, F is Faraday's constant ($96.5 \text{ kJ mol}^{-1} \text{V}^{-1}$) and ΔE° is the difference in standard reduction potentials between the two redox couples.

For example, in the following reaction:



the two half-reactions are

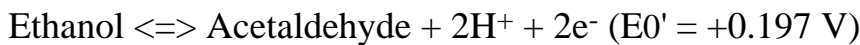
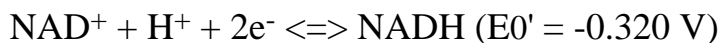

Note that the value of E° for the ethanol/aldehyde **oxidation** reaction above is the same magnitude, but opposite sign of the E° value given in [Table 15.1](#). This is because the reactions in [Table 15.1](#) are all written as reductions;

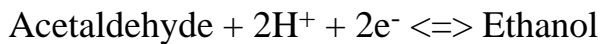

If a reaction is reversed, the sign of E° must be changed. The overall reaction is the sum of the two half-reactions, so ΔE° is given by

$$\Delta E^{\circ} = -0.320 \text{ V} + 0.197 \text{ V} = -0.123 \text{ V}$$

The standard **free energy** then is

$$\Delta G^{\circ} = -nF \Delta E^{\circ} = -2(96.5)(-0.123) \text{ kJ/mol} = 23.74 \text{ kJ/mol}$$

Thus, this reaction would not be favored under standard conditions (i.e., pH 7, 25°C, and of equal concentrations of reactants and products) and would go in the reverse direction.

The Nernst Equation makes it possible to calculate reduction potentials under nonstandard conditions;

$$E' = E'_0 + \frac{2.303RT}{nF} \log \frac{[\text{electron acceptor}]}{[\text{electron donor}]} \quad (15.4)$$

where R is the gas constant (8.314 J/°mol), T is the absolute temperature, and 2.303 is the conversion factor from natural base e to common (base 10) logarithms. At 25°C, the 2.303RT/nF term has the value of 0.059 V for a one-electron transfer and 0.0295 V (rounded to 0.03 V) for a two-electron transfer (n=2). Thus, the Nernst equation simplifies to

$$E' = E'_0 + 0.03 \log([\text{e}^- \text{ acceptor}]/[\text{e}^- \text{ donor}])$$

This is similar to the [Henderson-Hasselbalch equation](#):

$$\text{pH} = \text{pK}_a + \log([\text{proton acceptor}]/[\text{proton donor}])$$

Furthermore, in the same sense that pK_a is defined by the midpoint of an acid titration curve, E₀' is defined by the midpoint of an electrochemical titration, where electron acceptor and electron donor are present in equal concentrations.

Each of the coupled redox reactions in biological electron transport involves the transfer of electrons from one redox couple to another couple of higher reduction potential. Thus, each individual redox reaction in the sequence is exergonic under standard conditions. For electrons entering the respiratory chain as NADH, the overall reaction sequence is given by the following equation:

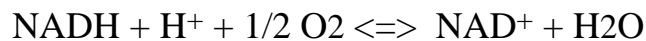

This sequence is strongly exergonic

$$\Delta G'^{\circ} = -nF \Delta E'_0 = -2(96.5)[0.82 - (-0.32)] \text{ kJ/mol} = -220 \text{ kJ/mol} \quad (15.6),$$

thus providing the **free energy** needed to synthesize ATP during oxidative phosphorylation.

See also: [Standard Reduction Potential](#), [Oxidations and Energy Generation](#), [Electron Transport](#), [Henderson-Hasselbalch Equation](#) (from Chapter 2).

Table 15.1

Oxidant	Reductant	n	E'_0 , V
Acetate + CO ₂ + 2H ⁺	Pyruvate + H ₂ O	2	-0.70
Succinate + CO ₂ + 2H ⁺	α-Ketoglutarate + H ₂ O	2	-0.67
Acetate + 3H ⁺	Acetaldehyde + H ₂ O	2	-0.60
O ₂	O ₂ ⁻	1	-0.45
Ferredoxin (oxidized)	Ferredoxin (reduced)	1	-0.43
2H ⁺	H ₂	2	-0.42
Acetoacetate + 2H ⁺	β-Hydroxybutyrate	2	-0.35
Pyruvate + CO ₂ + H ⁺	Malate	2	-0.33
NAD ⁺ + H ⁺	NADH	2	-0.32
NADP ⁺ + H ⁺	NADPH	2	-0.32
FMN (enzyme-bound) + 2H ⁺	FMNH ₂ (enzyme-bound)	2	-0.30
Lipoate (oxidized) + 2H ⁺	Lipoate (reduced)	2	-0.29
1,3-Bisphosphoglycerate + 2H ⁺	Glyceraldehyde-3-phosphate + P _i	2	-0.29
Glutathione (oxidized) + 2H ⁺	2 Glutathione (reduced)	2	-0.23
FAD + 2H ⁺	FADH ₂	2	-0.22
Acetaldehyde + 2H ⁺	Ethanol	2	-0.20
Pyruvate + 2H ⁺	Lactate	2	-0.19
Oxaloacetate + 2H ⁺	Malate	2	-0.17
α-Ketoglutarate + NH ₄ ⁺ + 2H ⁺	Glutamate + H ₂ O	2	-0.14
Methylene blue (oxidized) + 2H ⁺	Methylene blue (reduced)	2	0.01
Fumarate + 2H ⁺	Succinate	2	0.03
CoQ + 2H ⁺	CoQH ₂	2	0.04
Cytochrome <i>b</i> (+3)	Cytochrome <i>b</i> (+2)	1	0.07
Dehydroascorbate + 2H ⁺	Ascorbate	2	0.08
Cytochrome <i>c</i> ₁ (+3)	Cytochrome <i>c</i> ₁ (+2)	1	0.23
Cytochrome <i>c</i> (+3)	Cytochrome <i>c</i> (+2)	1	0.25
Cytochrome <i>a</i> (+3)	Cytochrome <i>a</i> (+2)	1	0.29
½O ₂ + H ₂ O	H ₂ O ₂	2	0.30
Ferricyanide	Ferrocyanide	2	0.36
Nitrate + 2H ⁺	Nitrite + H ₂ O	1	0.42
Cytochrome <i>a</i> ₃ (+3)	Cytochrome <i>a</i> ₃ (+2)	1	0.55
Fe (+3)	Fe (+2)	1	0.77
½O ₂ + 2H ⁺	H ₂ O	2	0.82

Note: E'_0 is the standard reduction potential at pH 7 and 25°C, n is the number of electrons transferred, and each potential is for the partial reaction written as follows: Oxidant + $ne^- \rightarrow$ reductant.

Henderson-Hasselbalch Equation

The **Henderson-Hasselbalch equation** describes the chemical composition of a buffer as a function of pH. With the **Henderson-Hasselbalch equation**,

$$\text{pH} = \text{pK}_a + \log \left\{ \frac{[\text{A}^-]}{[\text{HA}]} \right\} \text{ (see also, [Equation 2.10](#)),}$$

where [HA] is the concentration of the undissociated weak acid and [A⁻] is the concentration of the conjugate base of [HA], one can predict the pH of solutions of weak acids/weak bases or make buffers of desired pHs readily. This is a very simple equation of four variables, pH, pK_a, [A⁻], and [HA].

To solve the equation, you need three of the variables. The most common problem students have in solving the **Henderson-Hasselbalch equation** is understanding what they have been given. Consider the following problem:

What is the pH of a buffer mixture containing 1M acetic acid and 0.5M sodium acetate?

Answer - The concentration of acetic acid (1M) corresponds to the [HA] term and the concentration of acetate (from sodium acetate) (0.5M) corresponds to the [A⁻] term. From [Table 2.6](#), the pK_a of acetic acid is 4.76.

Thus, $\text{pH} = 4.76 + \log \left(\frac{[0.5]}{[1.0]} \right) = 4.46$.

See another example [here](#).

See also: [Ionic Equilibria and pH](#)

Equation 2.10

$$-\log [H^+] = -\log K_a + \log \frac{[A^-]}{[HA]} \quad (2.10)$$

Table 2.6

Acid (Proton Donor)		Conjugate Base (Proton Acceptor)		pK_a	K_a (M)
HCOOH Formic acid	\rightleftharpoons	HCOO ⁻ Formate ion	+H ⁺	3.75	1.78×10^{-4}
CH ₃ COOH Acetic acid	\rightleftharpoons	CH ₃ COO ⁻ Acetate ion	+H ⁺	4.76	1.74×10^{-5}
$\begin{array}{c} \text{OH} \\ \\ \text{CH}_3\text{CH}-\text{COOH} \end{array}$ Lactic acid	\rightleftharpoons	$\begin{array}{c} \text{OH} \\ \\ \text{CH}_3\text{CH}-\text{COO}^- \end{array}$ Lactate ion	+H ⁺	3.86	1.38×10^{-4}
H ₃ PO ₄ Phosphoric acid	\rightleftharpoons	H ₂ PO ₄ ⁻ Dihydrogen phosphate ion	+H ⁺	2.14	7.24×10^{-3}
H ₂ PO ₄ ⁻ Dihydrogen phosphate ion	\rightleftharpoons	HPO ₄ ²⁻ Monohydrogen phosphate ion	+H ⁺	6.86	1.38×10^{-7}
HPO ₄ ²⁻ Monohydrogen phosphate ion	\rightleftharpoons	PO ₄ ³⁻ Phosphate ion	+H ⁺	12.4	3.98×10^{-13}
H ₂ CO ₃ Carbonic acid	\rightleftharpoons	HCO ₃ ⁻ Bicarbonate ion	+H ⁺	6.37	4.27×10^{-7}
HCO ₃ ⁻ Bicarbonate ion	\rightleftharpoons	CO ₃ ²⁻ Carbonate ion	+H ⁺	10.25	5.62×10^{-11}
C ₆ H ₅ OH Phenol	\rightleftharpoons	C ₆ H ₅ O ⁻ Phenolate ion	+H ⁺	9.89	1.29×10^{-10}
NH ₄ ⁺ Ammonium ion	\rightleftharpoons	NH ₃ Ammonia	+H ⁺	9.25	5.62×10^{-10}

■ Phosphoric acid series ■ Carbonic acid series

Sample Buffer Calculation

Suppose a biochemist wishes to study a reaction at pH 4.00. To prevent the pH from drifting during the reaction, the experimenter should use a buffer solution consisting of a specific mixture of a weak acid and its conjugate base. From [Table 2.6](#), one discovers the pKa of formic acid (3.75) is close to the pH value required. An acetic acid-acetate mixture would not be so satisfactory, because the pKa of acetic acid (4.76) is nearly 1 pH unit away. The ratio of formate ion to formic acid required can be calculated from the Henderson - Hasselbalch equation:

$$4.00 = 3.75 + \log \frac{[\text{HCOO}^-]}{[\text{HCOOH}]} \quad (2.17)$$

which can be rewritten as

$$\frac{[\text{HCOO}^-]}{[\text{HCOOH}]} = 10^{0.25} = 1.78 \quad (2.18)$$

This equation tells us then that one can make a formate buffer at pH 4.0 by using 0.1 M formic acid (HA = HCOOH) and 0.178 M sodium formate (A⁻ = HCOO⁻). Alternatively, exactly the same solution could be prepared by titrating a 0.1 M solution of formic acid to pH 4.00 with sodium hydroxide.

See also: [Henderson-Hasselbalch Equation](#), [pKa](#)

Equation 2.17

$$4.00 = 3.75 + \log \frac{[\text{HCOO}^-]}{[\text{HCOOH}]} \quad (2.17)$$

K and pKa

Dissociation of an acid can be written in several possible ways:

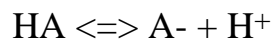
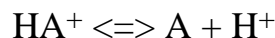

Note that in some cases the conjugate base (A, A⁻, or A²⁻) has a negative charge and in other cases it does not, but in all cases it has one less positive charge than the acid. For convenience, we will always write such reactions as $\text{HA} \rightleftharpoons \text{H}^+ + \text{A}^-$. The equilibrium constant (K_a) for the dissociation of a weak acid (often called the dissociation constant) is defined as

Equation 2.8

The larger K_a is, the greater is the tendency for the acid to dissociate, that is, the stronger the acid.

The strength of acids is usually expressed in terms of the pK_a value:

$$\text{pK}_a = -\log(\text{K}_a)$$

See also: [Table 2.6](#)

Equation 2.8

$$K_a = \frac{[H^+][A^-]}{[HA]} \quad (2.8)$$

Ionic Equilibria and pH

Ionic Equilibria - The common weak acids and bases found in biological systems do not completely **ionize** at physiological pH. Thus there is a measurable equilibrium between the weak acid and its conjugate base (the substance that can accept a proton to re-form the acid) or between the weak base and its conjugate acid (the substance that can give up a proton to re-form the base). [Table 2.6](#) lists examples of weak acids and their conjugate bases.

Although water is essentially a neutral molecule, it does **ionize** slightly as follows:

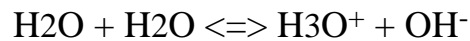

Thus, water acts as an acid (proton donor) and a base (proton acceptor) in what is called the **autoionization** of water. The **autoionization** of water can be simplified as follows:

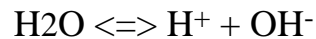

The equilibrium for the autoionization of water is given by K_w , the **ion product** constant of water. At 25 °C,

$$K_w = [\text{H}^+][\text{OH}^-] = 1 \times 10^{-14} \text{ M}^2$$

where $[\text{H}^+]$ is the hydrogen ion concentration and $[\text{OH}^-]$ is the hydroxide ion concentration. Because K_w is a constant, $[\text{H}^+]$ and $[\text{OH}^-]$ can vary independently. If $[\text{H}^+]$ increases, then $[\text{OH}^-]$ must decrease such that $[\text{H}^+][\text{OH}^-] = 1 \times 10^{-14}$, and vice versa.

A solution is said to be neutral when $[\text{H}^+] = [\text{OH}^-]$. At 25°C, $[\text{H}^+] = [\text{OH}^-] = 1 \times 10^{-7} \text{ M}$. Once $[\text{H}^+]$ is known, the pH of the solution can be calculated as follows:

$$\text{pH} = -\log[\text{H}^+]$$

For a neutral solution at 25°C, $\text{pH} = -\log(1 \times 10^{-7}) = 7$. A solution with a $\text{pH} < 7$ is said to be acidic, and one with a $\text{pH} > 7$ is said to be basic (see [Figure 2.16](#)). Most body fluids have pH values in the range 6.5 - 8.0, so this is often called the physiological pH range.

See also: [Henderson-Hasselbalch Equation](#), [The Structure and Properties of Water](#)

Figure 2.16: The pH scale and the physiological pH range.

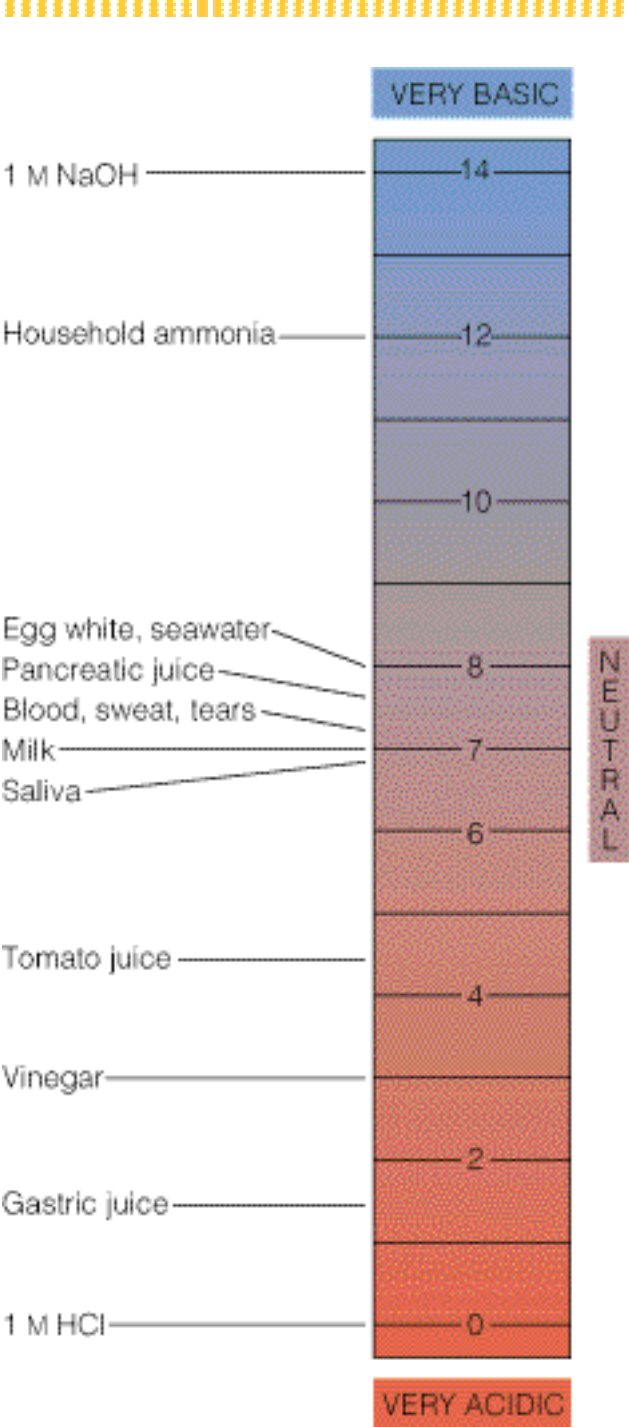

The Structure and Properties of Water

Table 2.4 reveals an important property of **water**. Its boiling point for its molecular weight (18) is high compared to other molecules. The reason is the strong tendency of **water** to form hydrogen bonds.

The electron arrangement of a single **water** molecule is shown in **Figure 2.9a**. Two of the outer six electrons of the oxygen atom are involved in covalent bonds to the hydrogens. The other four electrons exist in nonbonded pairs, which are excellent hydrogen bond acceptors. The OH groups in **water** are strong hydrogen bond donors. Each **water** molecule is simultaneously a hydrogen bond donor and a hydrogen bond acceptor, and a sample of **water** is a dynamic network of H-bonded molecules (**Figure 2.9b**).

The consequences of the extensive hydrogen-bonded network of **water** include:

1. High boiling point
2. High heat of vaporization (**Table 2.4**)
3. High viscosity (**Table 2.5**)
4. High surface tension
5. High dielectric constant

When **water** molecules freeze, the hydrogen bonding becomes most regular and clearly defined, creating a rigid tetrahedral molecular lattice in which each molecule is H-bonded to four others (**Figure 2.10a**). The lattice structure is only partially dismantled when ice melts, and some long-range order persists even at higher temperatures. The rather open structure of the ice lattice accounts for another of **water**'s unusual properties - liquid **water** is denser than its solid form, because when the lattice breaks down, molecules can move closer together.

The processes of life require a wide variety of ions and molecules to move about in proximity, that is, to be soluble in a common medium. **Water** serves as the universal intracellular and extracellular medium, thanks to its remarkable solvent ability. This ability arises primarily from two properties of **water**: its tendency to form hydrogen bonds and its dipolar character. Substances that can take advantage of these properties so as to readily dissolve in **water** are called hydrophilic, or "**water** loving."

Hydrophobic molecules do not dissolve readily, however, in water, and form a clathrate, cage-like structure (**Figure 2.13**) when mixed with water.

See also: [Hydrogen Bonds](#), [Dielectric Constant](#), [Covalent Bonds vs Non-Covalent Forces](#), [Clathrate Structure of Water](#)

Figure 2.9: Hydrogen bonding in water.

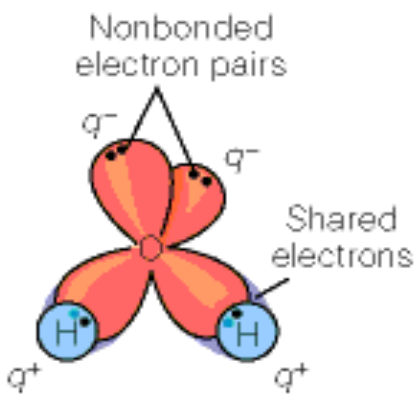

(a) Electron structure of a water molecule

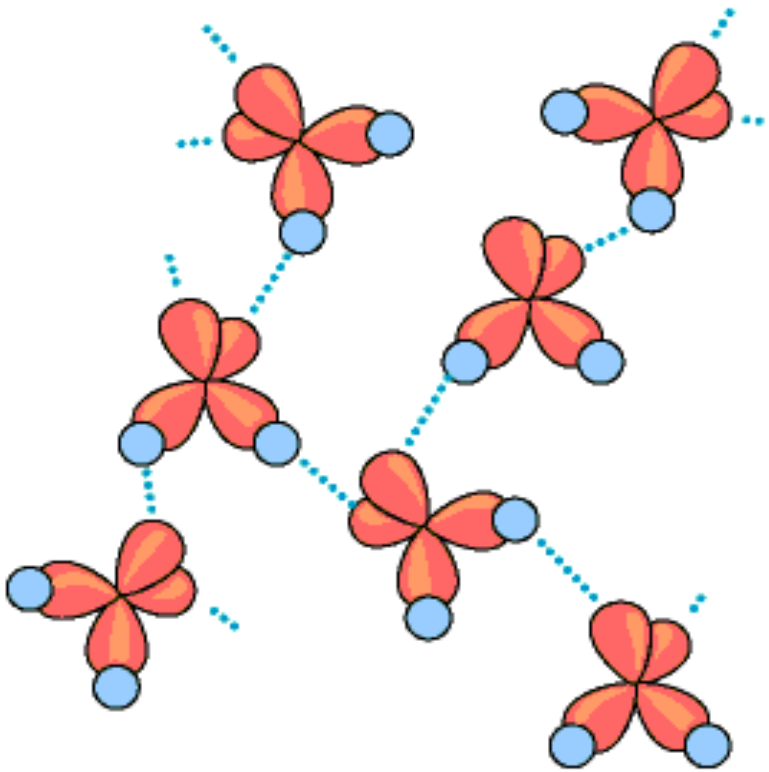

(b) Hydrogen bonding in water

Figure 2.10: Water as a molecular lattice.

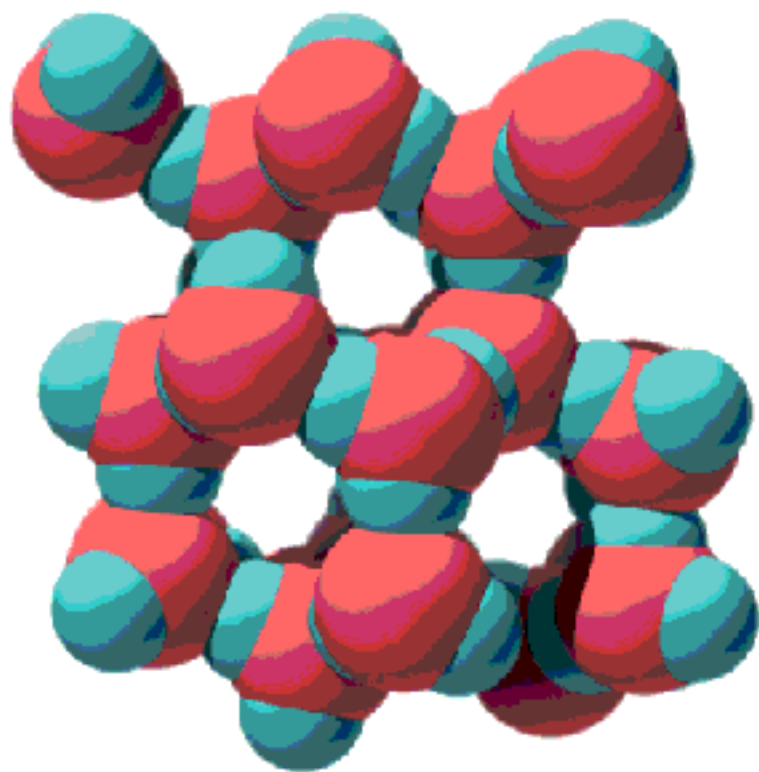

(a)

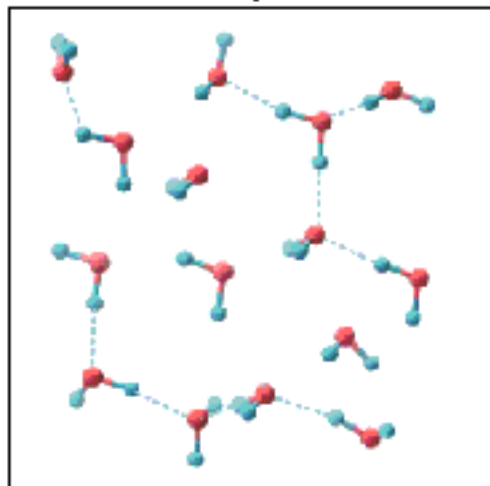
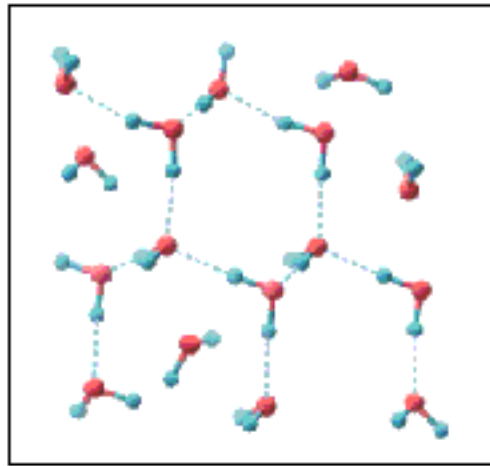
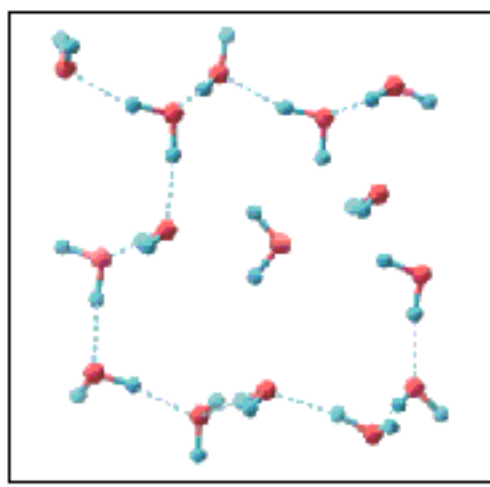

(c)

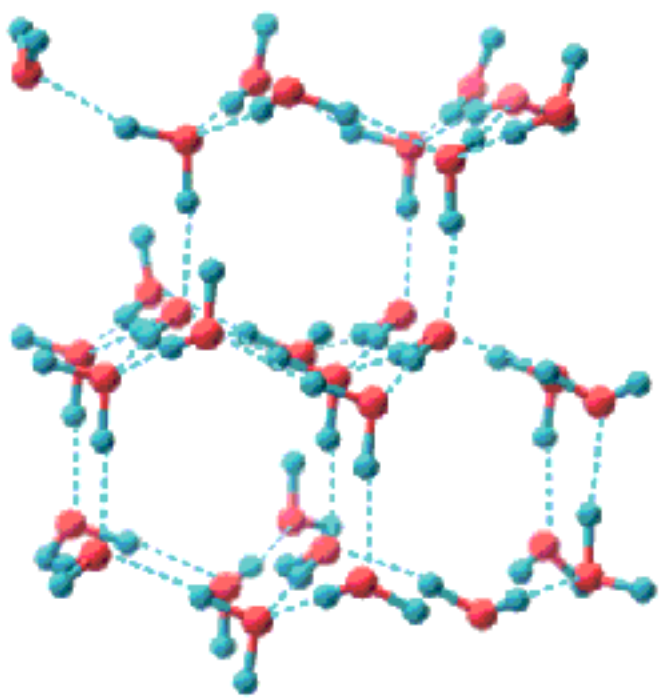

(b)

(a-b) Adapted from L. Pauling and P. Pauling, *Chemistry* (New York, NY: W. H. Freeman, 1975), p. 289.

Figure 2.13: One unit of clathrate structure surrounding a hydrophobic molecule (yellow).

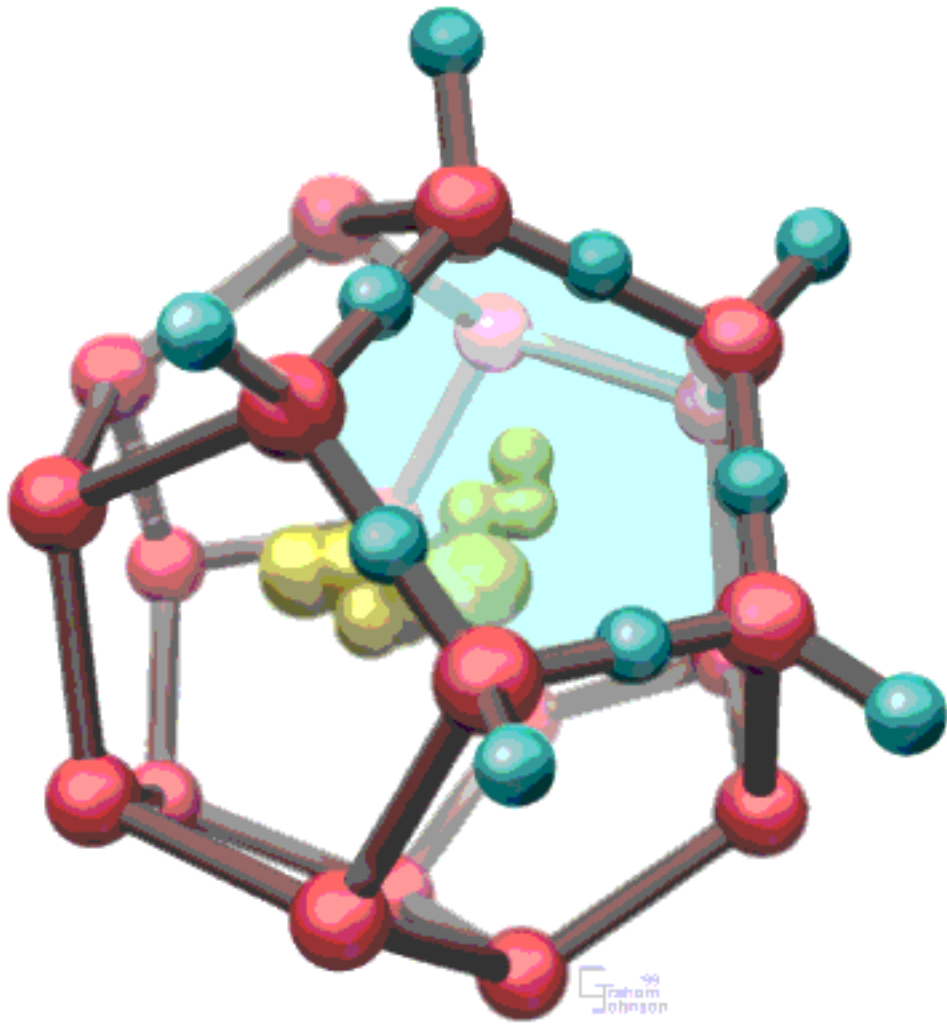

Nucleic Acid Sequences



The asymmetry of the nucleoside monophosphate monomers of **nucleic acids** gives the strand a "polarity". We describe the polarity relative to the numbering of the carbons in the sugar (**ribose** in **RNA**; **deoxyribose** in **DNA**). For example, in **Figure 4.1**, the strand is said to be oriented 5' to 3' as it goes from top to bottom.

When writing a sequence of bases from a nucleic acid, it is important to indicate the polarity of the strand on which they are located. For example, one way to do this for RNA is:

5' GGAUACUUGCA3'

The general convention is to write sequences with the 5' end on the left and the 3' end on the right. To be technically accurate, a sequence should always indicate polarity. DNA sequences are occasionally written as

5' dGdTdCdCdTdGdA 3'

where the "d" distinguishes a deoxyribonucleotide from a ribonucleotide, but DNA sequences are more commonly written without the "d" as follows:

5' GTCCTGA 3'

See also: [Nucleoside and Nucleotide Naming](#)

Nucleosides and Nucleotide Naming

Nucleic acids (**DNA** and **RNA**) are heterologous polymers of **nucleosides** monophosphates (**Figure 4.3**). In order to help you remember the difference between **nucleosides** and **nucleotides**, keep in mind the following:

1. **Nucleosides** are composed of a sugar and a base.
2. **Nucleotides** are composed of a sugar, a base, and a phosphate.
3. **Nucleoside** monophosphates are the same as a **nucleotides**.

The last point frequently confuses students. However, it is just another way of saying that a **nucleoside** with a phosphate covalently attached to it is a **nucleotide**. Note also that it is redundant to refer to a **nucleotide** monophosphate - a **nucleotide** has at least one phosphate by definition.

The terms **nucleoside** and **nucleotide** are used to refer generically to these molecules. **Nucleosides** containing the sugar ribose are referred to precisely as ribonucleosides. Similarly, nucleotides containing the sugar **ribose** are called ribonucleotides. If the sugar present is **deoxyribose**, the precise names are deoxyribonucleosides and deoxyribonucleotides.

Nucleotides contain at least one phosphate, but they may have more. For example, ATP (adenosine triphosphate) contains three phosphates, making it a **nucleoside** triphosphate. Though the repeating units of DNA and RNA are **nucleoside** monophosphates, cells use **nucleoside** triphosphates to build nucleic acids because the energy derived from hydrolyzing two of the phosphate groups in the triphosphate helps to drive the reaction.

See also: [Nucleotide Properties](#), [Phosphodiester Bonds](#)

Figure 4.3: Nucleosides and nucleotides.

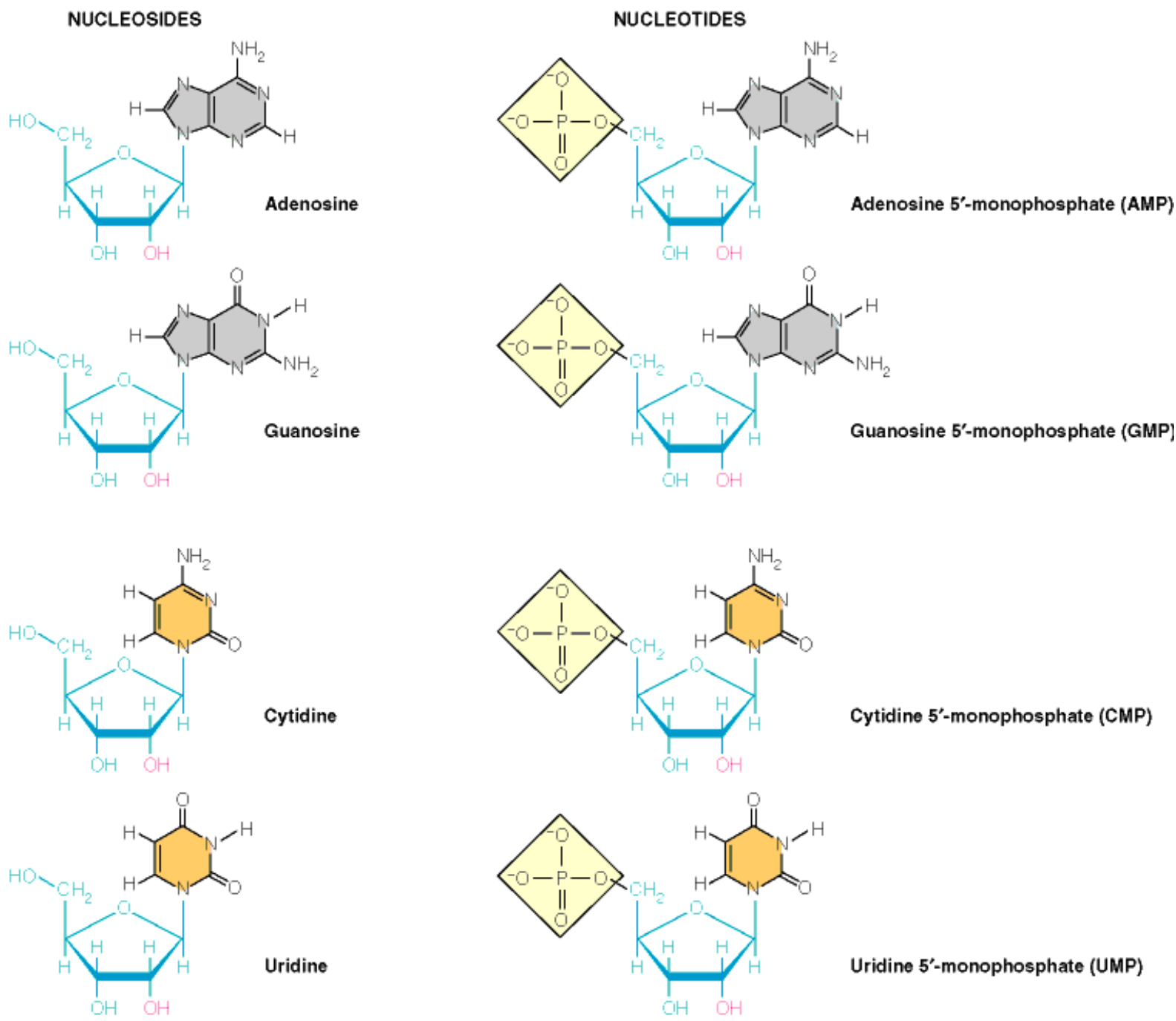

Nucleotide Properties

Nucleotides consists of a sugar ([ribose](#) in **RNA** and 2'-[deoxyribose](#) in **DNA**), a heterocyclic base, and at least one phosphate group. The heterocyclic base – [adenine](#) (A), [guanine](#) (G), [cytosine](#) (C), and [uracil](#) (U) in RNA, and A,G, C, and [thymine](#) (T) in DNA – attaches to the 1' carbon of the sugar via what is called a glycosidic bond (see [here](#)). The phosphate group attaches to the 5' hydroxyl group of the sugar. These structural features give **nucleotides** the following properties:

1. The phosphate group of a **nucleotide** acts as a strong acid ($pK_a \approx 1$), and this is why DNA and RNA are called [nucleic acids](#).
2. The amine groups of the [purine](#) and [pyrimidine](#) bases can be protonated.
3. The bases can tautomerize; that is, the bases can redistribute positions of hydrogens and double bonds ([Figure 4.4](#)).
4. **Nucleotides** absorb light strongly in the near-ultraviolet region of the spectrum. This makes it possible to use spectrophotometry to quantitate DNA and RNA ([Figure 4.5](#)).

See also: [Nucleoside and Nucleotide Naming](#), [Phosphodiester Bonds](#), [Polynucleotide Structures](#), [Nucleosides](#)

Cytosine

Cytosine is a pyrimidine base found in DNA and RNA. In nucleosides and nucleotides, **cytosine** is linked to the sugar moiety via a covalent bond between nitrogen #1 of **cytosine** and carbon #1 of the sugar.

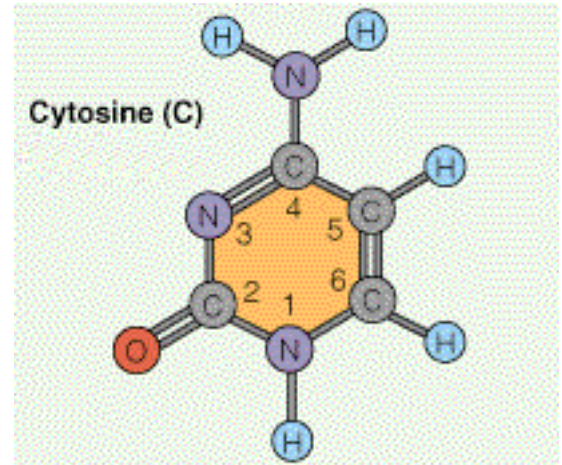

The ribonucleoside containing **cytosine** is called cytidine. The deoxyribonucleoside containing **cytosine** is called deoxycytidine.

See also: Figure 4.3, Figure 4.2, De Novo Pyrimidine Nucleotide Metabolism, Nucleotide Salvage Synthesis, Pyrimidine Catabolism

Cytidine

Cytidine is a nucleoside containing cytosine. **Cytidine** differs from **cytosine** in containing a sugar (**ribose**). Phosphorylation of **cytidine** produces a **nucleotide** found in **RNA**.

Deoxycytidine is a related nucleoside that contains **deoxyribose** instead of ribose as the sugar.

See also: [Nucleosides](#), [Deoxycytidine](#), [Figure 4.3](#), [DNA](#)

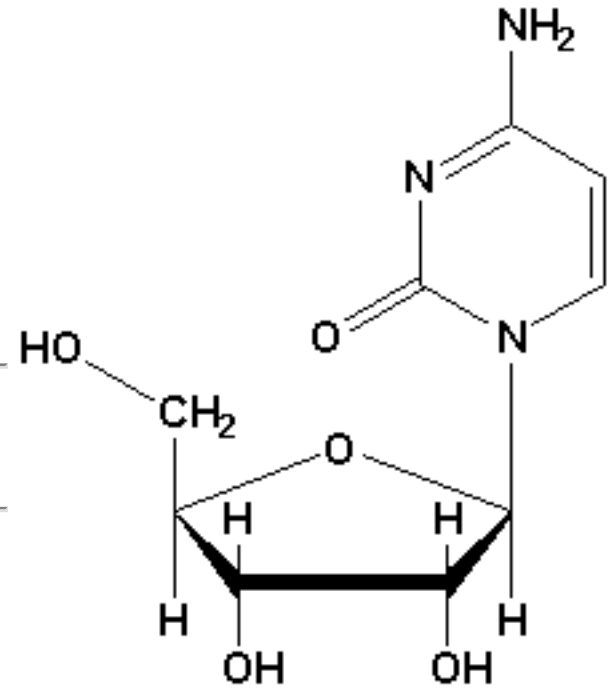

Cytidine

Deoxycytidine

Deoxycytidine is a **nucleoside** containing **cytosine**.

Deoxycytidine differs from cytosine in containing a sugar (**deoxyribose**). Phosphorylation of **deoxycytidine** produces a **nucleotide** found in **DNA**.

Cytidine is a related nucleoside that contains **ribose** instead of deoxyribose as the sugar.

See also: [Figure 4.3](#), [RNA](#), [De Novo Pyrimidine Nucleotide Metabolism](#), [Nucleotide Salvage Synthesis](#), [Pyrimidine Catabolism](#)

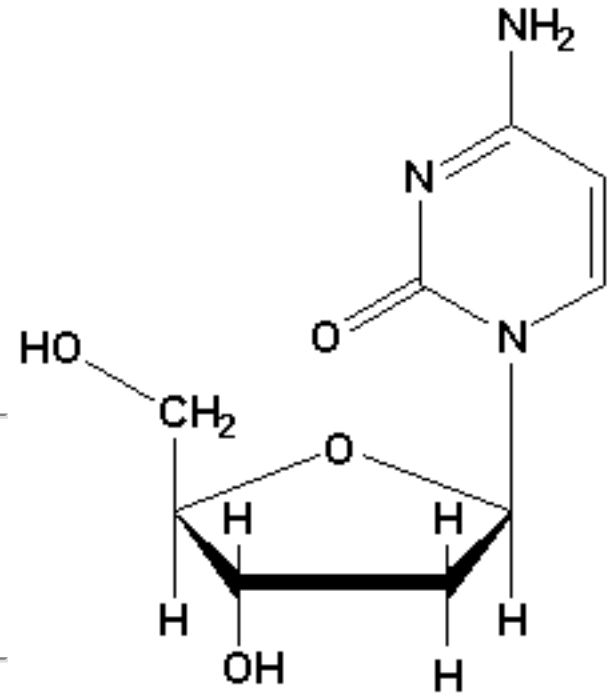

Deoxycytidine

Pyrimidine Catabolism

Pathways for **pyrimidine catabolism** are shown in [Figure 22.11](#). **Pyrimidine** bases are broken down through a common [uracil](#) intermediate, which is subsequently converted to [dihydrouracil](#), followed by [β-ureidopropionic acid](#), and finally [β-alanine](#), ammonia and CO₂.

One of the breakdown products, β-alanine, is used for biosynthesis of [coenzyme A](#).

See also: [Nucleotide Salvage Synthesis](#), [De Novo Pyrimidine Nucleotide Metabolism](#)

Figure 22.11: Catabolic pathways in pyrimidine nucleotide metabolism.

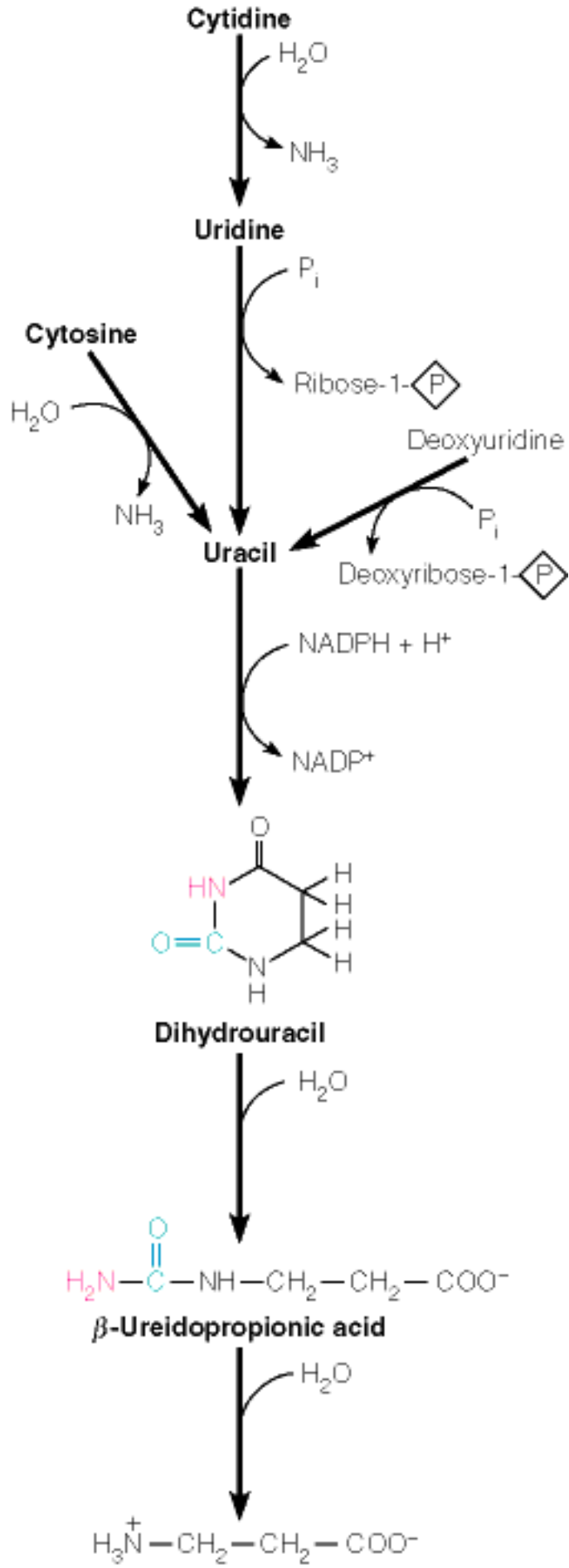

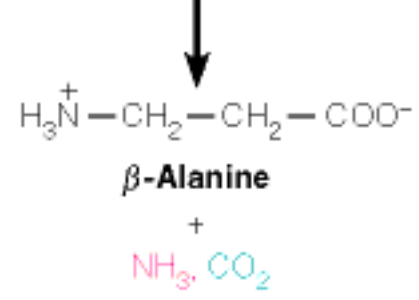

Dihydrouracil

Dihydrouracil is an intermediate in catabolism of pyrimidines ([Figure 22.11](#)). It is formed by reduction of [uracil](#) ([Figure 22.11](#)) and then converted to β -ureidopropionic acid as shown in the reaction that follows:



See also: [Pyrimidine Catabolism](#)

INTERNET LINK: [Pyrimidine Metabolism](#)

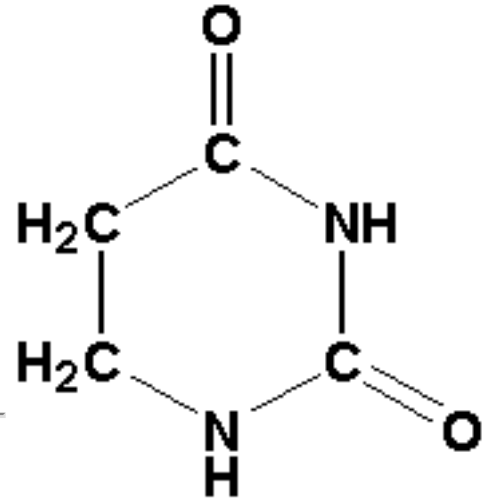

Dihydrouracil

Hydropyrimidine Hydratase

Hydropyrimidine hydratase catalyzes the following reaction in pyrimidine catabolism:

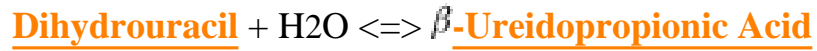

See also: [Figure 22.11, Pyrimidine Nucleotide Catabolism](#)

INTERNET LINK: [Pyrimidine Metabolism](#)

β -Ureidopropionase

β -Ureidopropionase is an enzyme in pyrimidine catabolism that catalyzes the reaction that follows:

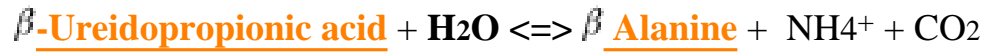

See also: [Figure 22.11, Pyrimidine Nucleotide Catabolism](#)

INTERNET LINK: [Pyrimidine Metabolism](#)

Figure 4.2: Purine and pyrimidine bases found in DNA and RNA.

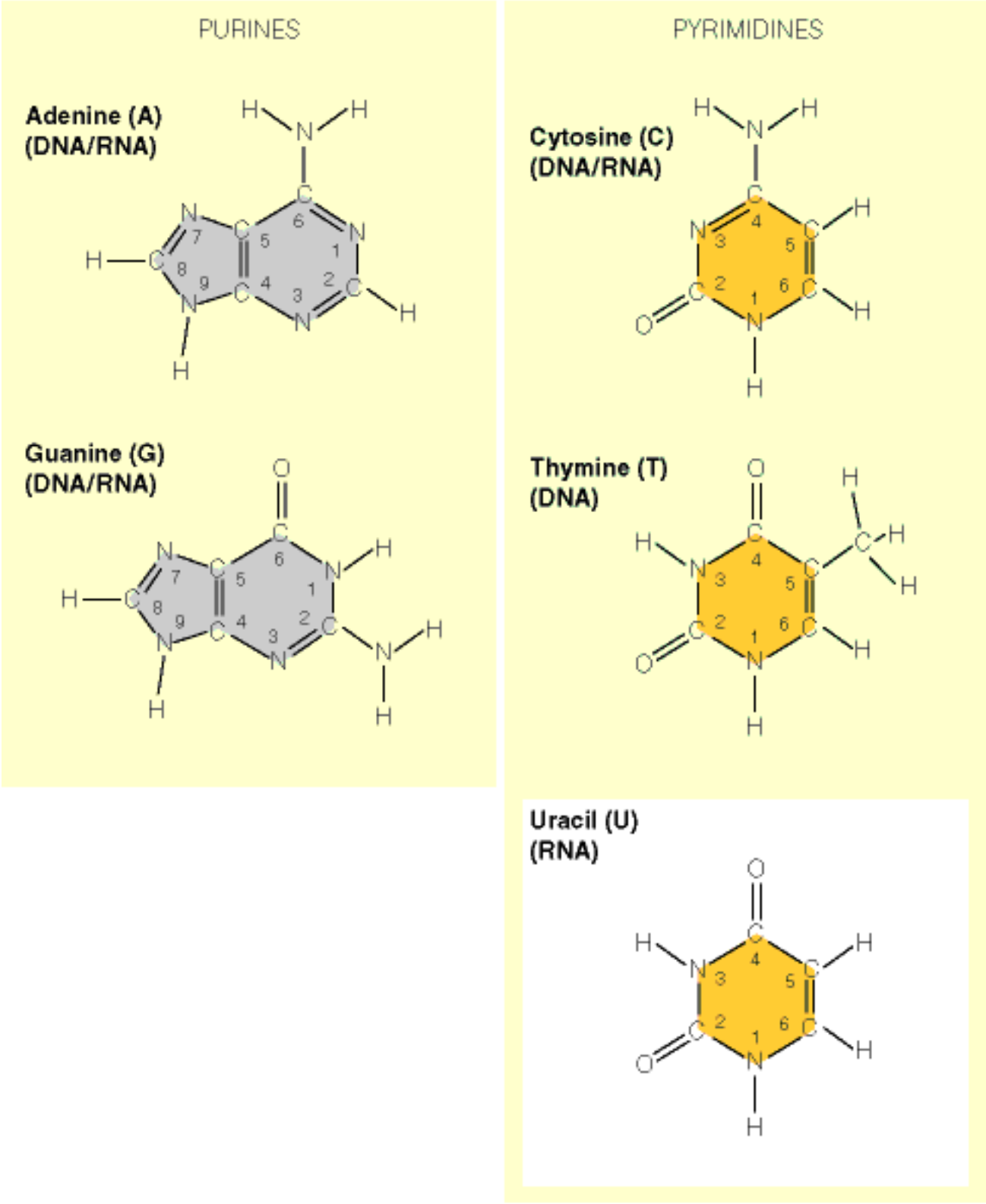

Thymidine

Thymidine (also called **deoxythymidine**) is a **nucleoside** containing **thymine**. **Thymidine** differs from thymine in containing a sugar.

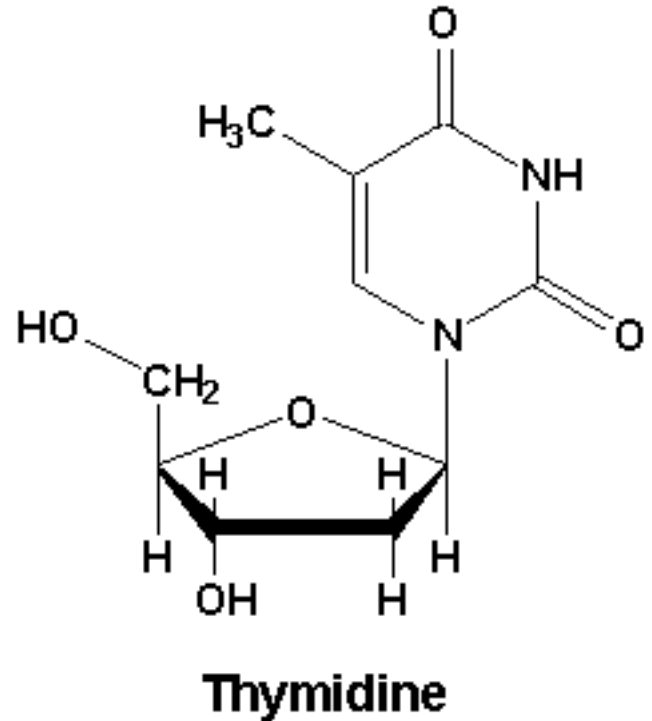

Phosphorylation of **thymidine** produces a **nucleotide** found almost exclusively in **DNA**.

See also: [Figure 4.3, Biosynthesis of Thymine Deoxyribonucleotides, Salvage Routes to Deoxyribonucleotide Synthesis](#)

Biosynthesis of Thymine Deoxyribonucleotides

Synthesis of deoxythymidine nucleotides occurs differently from that of the other dNTPs, which are derived directly from a **ribonucleotide reductase**-catalyzed conversion of ribonucleoside diphosphates to deoxyribonucleoside diphosphates (**Figure 22.12**). The terms thymidine and deoxythymidine (or **dTTP** and TTP) generally refer to the deoxyribonucleotide, because the ribonucleotide is not a normal metabolite. In the rare instances where the ribonucleotide of thymidine occurs, it is usually designated with an 'r' preceding it, as in rTTP.

Figure 22.17 shows the complicated *de novo* and salvage pathways for the synthesis of dTTP. The *de novo* pathways start at the top with either **UDP** or **CDP** and lead to dTTP. The salvage pathways begin with **deoxycytidine**, **deoxyuridine**, or **deoxythymidine** nucleosides, which are each converted to nucleoside monophosphates in the first step by appropriate kinases.

There are several points of regulation in the synthesis. For example, **dCTP** inhibits the salvage reaction catalyzed by **deoxycytidine kinase** and activates the reaction catalyzed by **dCMP deaminase**. On the other hand, dTTP inhibits the dCMP deaminase reaction and the enzyme thymidine kinase.

Note that conversion of dUMP to dTMP requires transfer of a single carbon from **5,10-methylenetetrahydrofolate** in the reaction catalyzed by **thymidylate synthase**. The relationship between thymidylate synthase and the enzymes of tetrahydrofolate metabolism is shown in **Figure 22.18**. The reaction catalyzed by thymidylate synthase is the only one known in the cell in which **tetrahydrofolate** is not regenerated. **Dihydrofolate reductase**, thus, plays an essential role in the ultimate regeneration of 5,10-methylene tetrahydrofolate. This enzyme, which can be inhibited by the drug **methotrexate**, is a target of some anticancer treatments.

See also: **Ribonucleotide Reductase and Deoxyribonucleotide Biosynthesis**, **Deoxyuridine Nucleotide Metabolism**, **Salvage Routes to Deoxyribonucleotide Synthesis**, **Nucleotide Analogs in Selection**.

Deoxythymidine Triphosphate (dTTP)

dTTP is a substrate for DNA polymerase in synthesis of DNA. It is produced from dTDP by nucleoside diphosphokinase catalysis as follows:

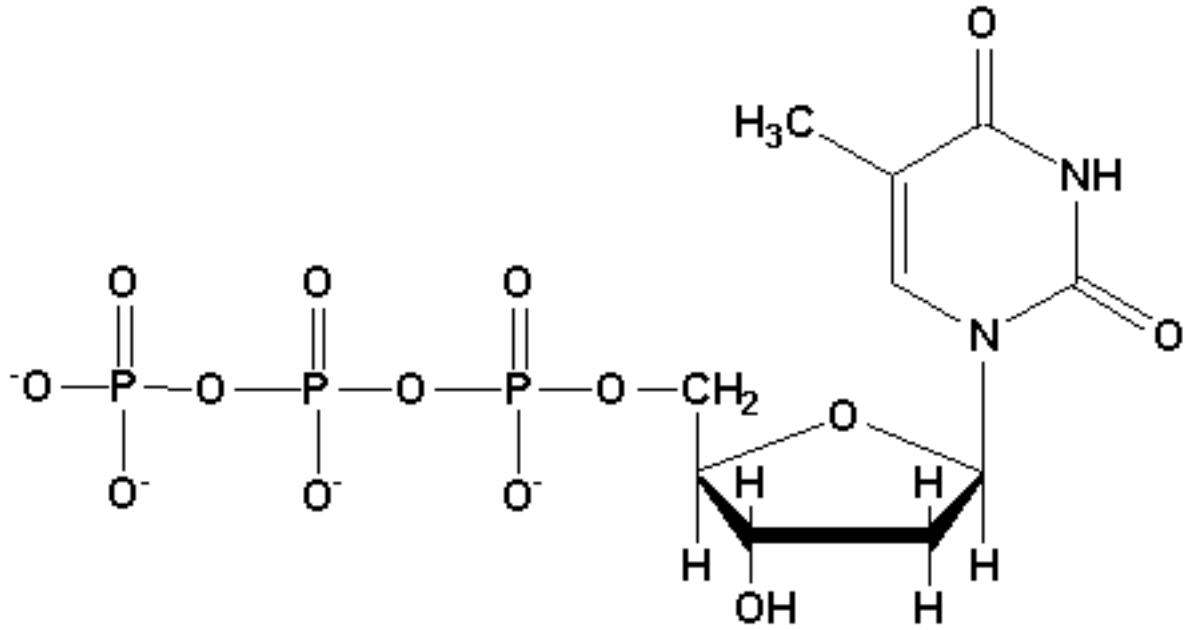

Deoxythymidine Triphosphate (dTTP)

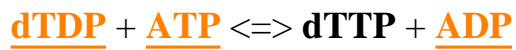

See also: Nucleotides, Biosynthesis of Thymine Deoxyribonucleotides

Deoxythymidine Diphosphate (dTDP)

dTDP is a deoxyribonucleotide produced from **dTMP** via either *de novo* ([Figure 22.18](#)) or salvage synthesis ([Figure 22.17](#)). Phosphorylation of **dTDP** yields **dTTP**, a substrate for DNA polymerase in synthesis of **DNA**.

See also: [Nucleotides](#),
[Biosynthesis of Thymine](#)
[Deoxyribonucleotides](#)

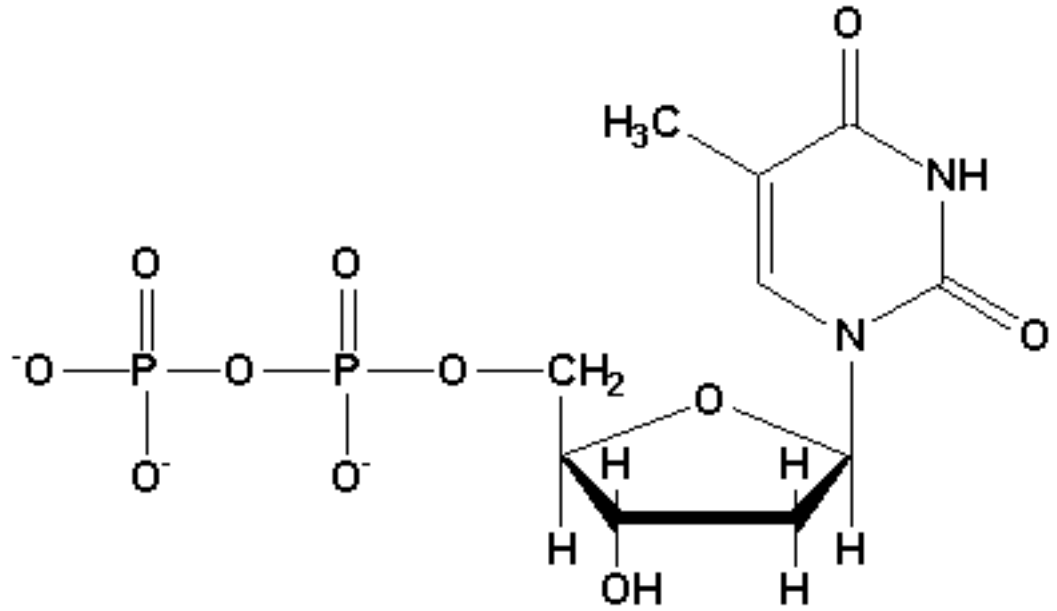

Deoxythymidine diphosphate (dTDP)

Deoxythymidine Monophosphate (dTMP)

dTMP is an intermediate in *de novo* ([Figure 22.18](#)) and salvage synthesis ([Figure 22.17](#)) of **dTTP**.

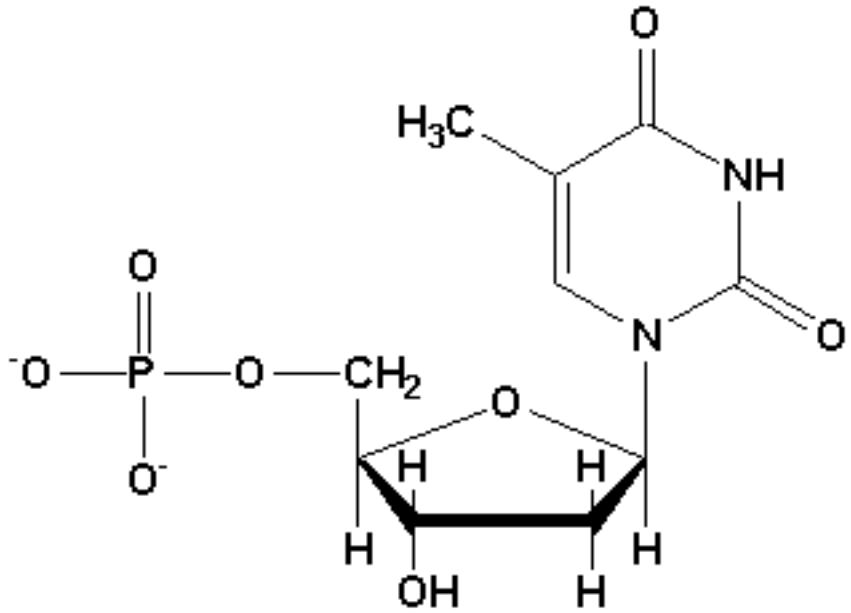

Deoxythymidine Monophosphate (dTMP)

See also: [Nucleotides](#), [Biosynthesis of Thymine Deoxyribonucleotides](#)

Figure 22.18: Relationship between thymidylate synthase and enzymes of tetrahydrofolate metabolism.

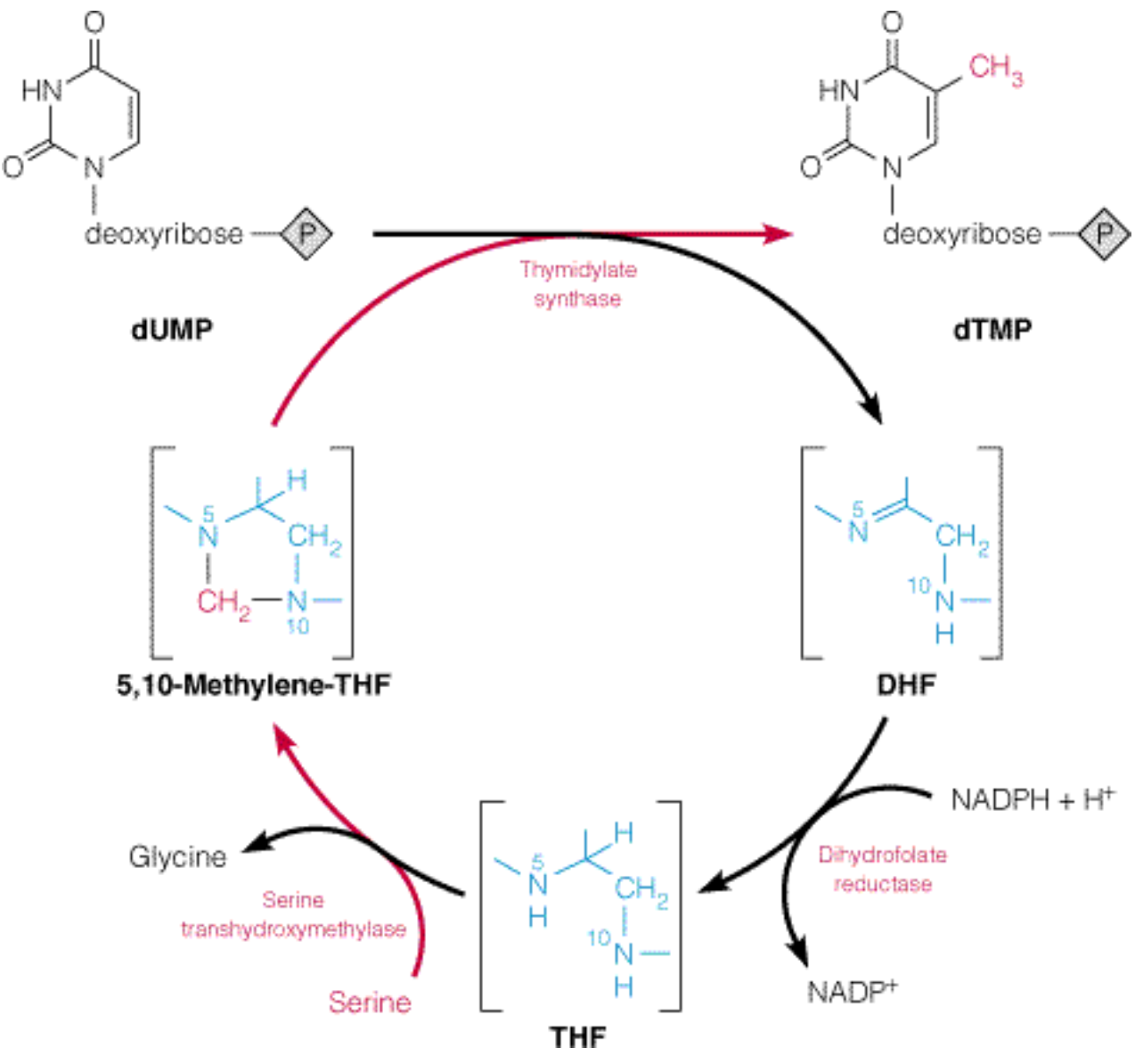
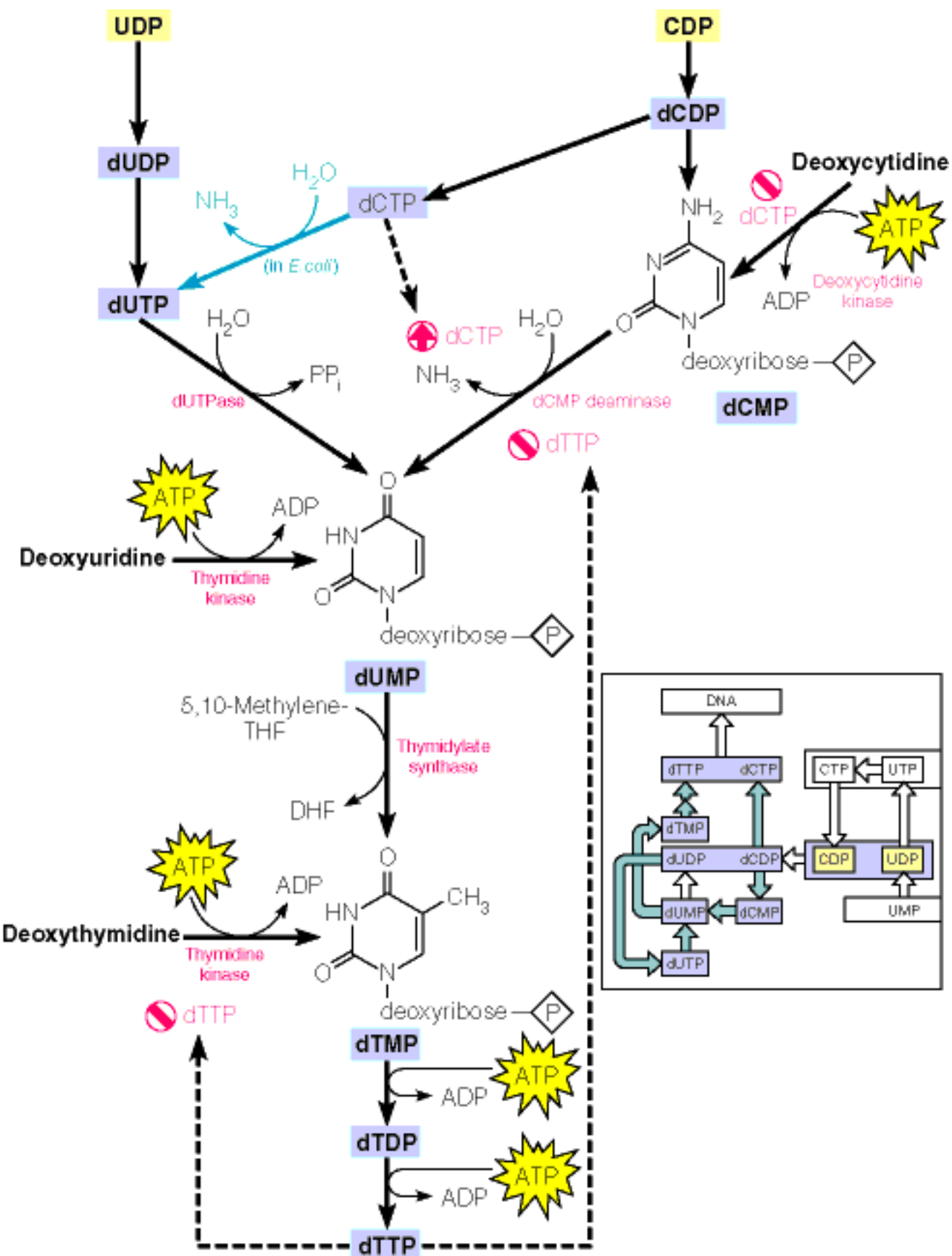
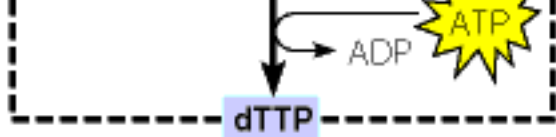

Figure 22.17: Salvage and *de novo* synthetic pathways to thymine nucleotides.





Deoxycytidine Triphosphate (dCTP)

dCTP is a substrate for DNA polymerase in synthesis of DNA. It is produced from dCDP by **nucleoside diphosphokinase** catalysis as follows:

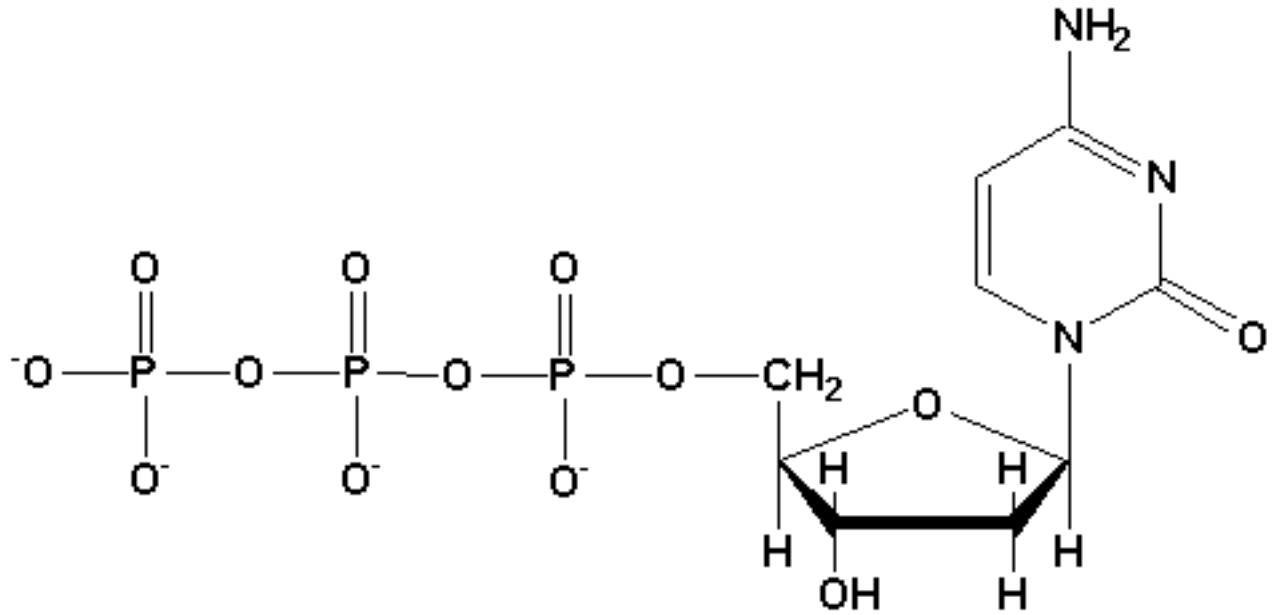

Deoxycytidine Triphosphate (dCTP)

dCTP is an allosteric inhibitor of **deoxycytidine kinase**

See also: **Nucleotides**

Deoxycytidine Kinase

Deoxycytidine kinase is an enzyme catalyzing the phosphorylation of [deoxycytidine](#) in nucleotide salvage biosynthesis. It will also phosphorylate [deoxyadenosine](#) and [deoxyguanosine](#) when these compounds are present at higher concentrations. **Deoxycytidine kinase** is inhibited by [dCTP](#). Unlike [thymidine kinase](#), whose activity fluctuates over the course of the cell cycle, the activity of **deoxycytidine kinase** stays relatively constant.

See also: [Salvage Routes to Deoxyribonucleotide Synthesis](#), [Nucleosides](#), [dCTP](#)

Deoxyadenosine

Deoxyadenosine is a nucleoside containing [adenine](#).

Deoxyadenosine differs from adenine in containing a sugar ([deoxyribose](#)). Phosphorylation of

deoxyadenosine produces a nucleotide found in [DNA](#).

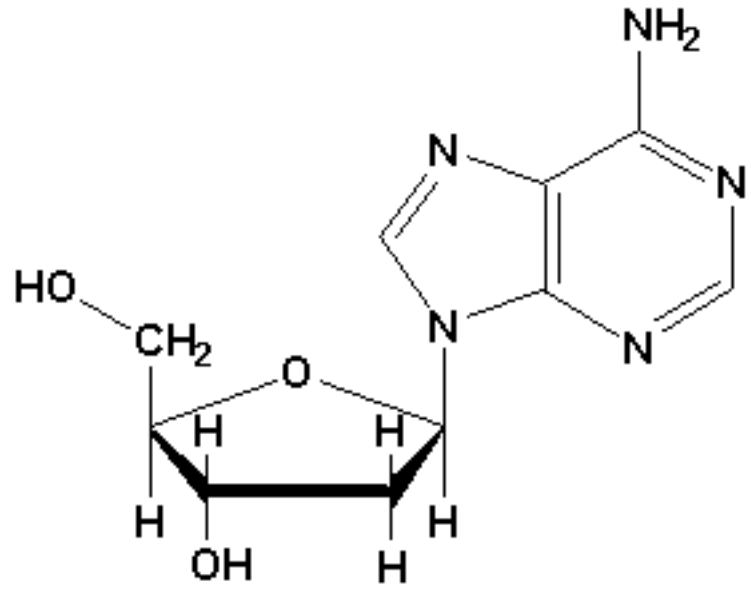

Deoxyadenosine

[Adenosine](#) is a related nucleoside that contains [ribose](#) instead of deoxyribose as the sugar.

See also: [Figure 4.3](#), [Nucleosides](#), [Nucleotides](#), [RNA](#)

Adenosine

Adenosine is a nucleoside containing [adenine](#).

Adenosine differs from adenine in containing a sugar ([ribose](#)). Phosphorylation of **adenosine** produces a nucleotide found in [RNA](#).

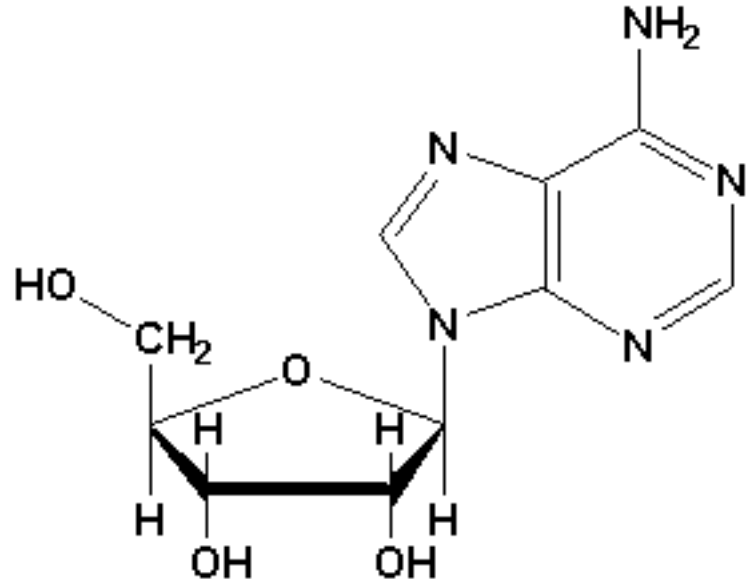

Adenosine

Deoxyadenosine is a related nucleoside. It contains [deoxyribose](#) instead of ribose as the sugar.

Phosphorylation of **deoxyadenosine** produces a nucleotide found in [DNA](#).

See also: [Deoxyadenosine](#), [Figure 4.3](#), [Nucleosides](#), [Nucleotides](#), [De Novo Biosynthesis of Purine Nucleotides](#)

Deoxyguanosine

Deoxyguanosine is a nucleosides containing guanine. **Deoxyguanosine** differs from guanine in containing a sugar (deoxyribose). Phosphorylation of **deoxyadenosine** produces a nucleotide found in DNA.

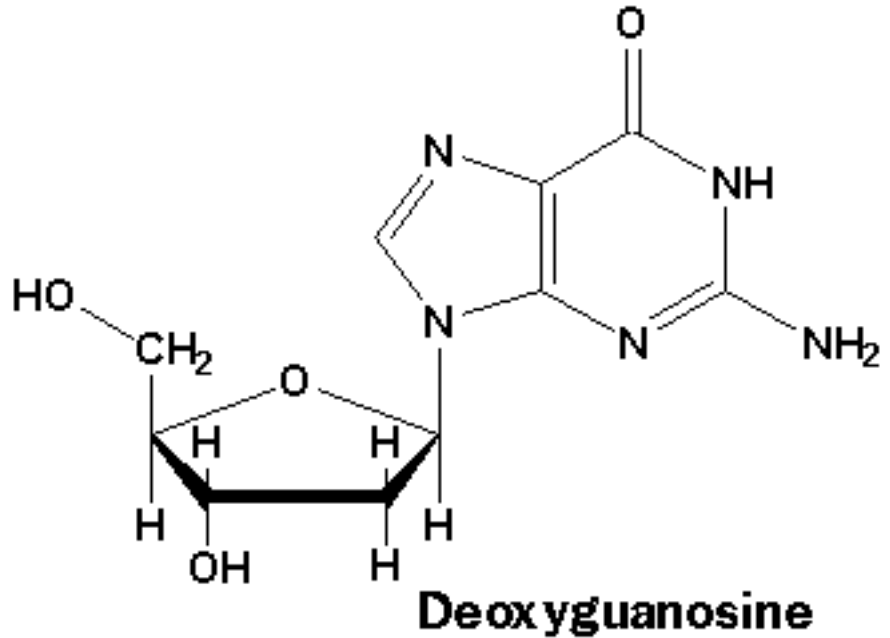

Guanosine is a related nucleoside that contains Ribose instead of deoxyribose as the sugar.

See also: [Figure 4.3, RNA, De Novo Biosynthesis of Purine Nucleotides, Ribonucleotide Reductase and Deoxyribonucleotide Biosynthesis](#), [Salvage Routes to Deoxyribonucleotide Synthesis](#)

Salvage Routes to Deoxyribonucleotide Synthesis

Purine salvage usually involves phosphoribosyltransferase reactions, which generate ribonucleoside monophosphates (rNMPs) from the purine bases and 5-phosphoribosyl-1-pyrophosphate (**PRPP**). These are phosphorylated to diphosphates (rNDPs) and then reduced to deoxyribonucleotides (dNDPs) with **ribonucleotide reductase**.

Another salvage route to making deoxyribonucleotides is *via* deoxyribonucleoside kinases, which can phosphorylate nucleosides to make nucleoside monophosphates. Human cells have four different deoxyribonucleoside kinases:

1. **Thymidine kinase** (located in the cytosol) - phosphorylates **deoxythymidine**;
2. **Deoxycytidine kinase** (located in cytosol) - phosphorylates **deoxycytidine**; also phosphorylates **deoxyadenosine** and **deoxyguanosine** at higher concentrations;
3. **Deoxyguanosine kinase** (located in mitochondria) - acts on deoxyguanosine; and
4. **Thymidine kinase** (located in mitochondria) - acts on deoxythymidine, deoxycytidine, and deoxyuridine

The activity of mitochondrial thymidine kinase is sufficiently broad that it will also act on the anti-HIV drug, 3'-azido-2'3'-dideoxythymidine (**AZT**). That is, the enzyme can phosphorylate AZT to a deoxyribonucleotide of azidothymidine, which is then incorporated into DNA. Evidence suggests that deoxyribonucleotides of AZT interfere with mitochondrial function, possibly by inhibiting mitochondrial DNA replication or transcription, which may explain some of the side effects of cardiotoxicity (damage to the heart muscle) observed with its use.

Cytosolic thymidine kinase salvages exogenous thymidine extremely efficiently. Experiments with radiolabeled precursors show that **dTTP** derived from salvage synthesis is usually incorporated into DNA in preference to thymidine nucleotides generated by *de novo* synthesis.

See also: **Biosynthesis of Thymine Deoxyribonucleotides**, **Deoxyuridine Nucleotide Metabolism**, **Ribonucleotide Reductase and Deoxyribonucleotide Biosynthesis**, **Regulation of Ribonucleotide Reductase**, **Drug Design**, **Nucleotide Analogs in Medicine**

Thymidine Kinase (TK)

Thymidine kinase is an enzyme that catalyzes the reaction that follows ([Figure 22.17](#)):



The form of the enzyme found in the cytosol acts only on deoxythymidine. The **thymidine kinase** found in the mitochondria acts on deoxythymidine, [deoxycytidine](#), and [deoxyuridine](#). The mitochondrial thymidine kinase's activity is sufficiently broad that it will also act on the anti-HIV drug, 3'-azido-2'-dideoxythymidine ([AZT](#)). Evidence suggest that deoxyribonucleotides of AZT interfere with mitochondrial function, possibly by inhibiting mitochondrial DNA replication or transcription, which may explain some of the side effects of cardiotoxicity observed with its use.

The ability of cells to uptake [thymidine](#) and phosphorylate it is exploited in the so-called HAT selection medium (see [here](#)), which selects for cells that have functional nucleotide salvage pathways.

See also: [Nucleotide Analogs in Selection](#), [Deoxycytidine Kinase](#), [BrdUrd](#), [Salvage Routes to Deoxyribonucleotide Synthesis](#), [Nucleotide Analogs in Medicine](#)

Deoxyuridine

Deoxyuridine is a **nucleoside** containing **uracil**. **Deoxyuridine** differs from uracil in containing a sugar (**deoxyribose**).

Phosphorylation of **deoxyuridine** produces a **nucleotides** present on rare occasions in **DNA**.

Uridine is a related nucleoside that contains **ribose** instead of deoxyribose as the sugar.

See also: [Figure 4.3](#), [RNA](#), [De Novo Pyrimidine Nucleotide Metabolism](#), [Nucleotide Salvage Synthesis](#), [Deoxyuridine Nucleotide Metabolism](#)

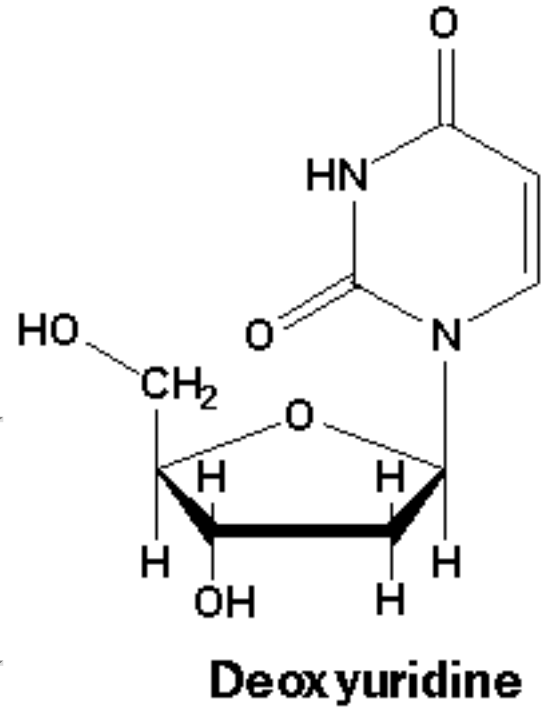

Deoxyuridine Nucleotide Metabolism

Figure 22.17 outlines the *de novo* and salvage synthetic pathways to thymine nucleotides. **dUTP**, an intermediate in the *de novo* pathways that begins with **UDP**, is readily recognized by DNA polymerases and can be incorporated into DNA in place of **dTTP**. The uracil from a **dUMP** residue in a DNA strand pairs with **adenine** (like **thymine** from a **dTMP** residue would), so there is no loss of or change in information in the DNA. However, **dUMP** residues can also arise from spontaneous deamination of **dCMP**. When this DNA is replicated, a mutation at the site will result because **cytosine** is meant to pair with **guanine**, not adenine.

To avoid incorporating **uridines** into DNA, cells have developed a rather a simple mechanism. The enzyme, **dUTPase**, converts dUTP (a substrate for incorporation into DNA) to dUMP (not a substrate for incorporation into DNA), and also provides a route to synthesis of **thymidine** nucleotides because the dUMP, in turn, is converted first to dTMP then to dTTP (**Figure 22.17**).

See also: [Biosynthesis of Thymine Deoxyribonucleotides](#), [Salvage Routes to Deoxyribonucleotide Synthesis](#), [Base Excision Repair](#) (from Chapter 25), [Figure 25.13](#)

INTERNET LINKS:

1. [Purine Metabolism](#)
 2. [Purine and Pyrimidine Metabolism](#)
 3. [Pyrimidine Metabolism](#)
-

Deoxyuridine Triphosphate (UTP)

dUTP is a deoxyribonucleotide intermediate in pyrimidine biosynthesis that is produced by phosphorylation of **dUDP**. **dUTP** is quickly cleaved in cells by **dUTPase** to yield **dUMP**. This reaction is part of the *de novo* synthetic pathway for **dTTP**. Removal of dUTP quickly is important in cells, because the **uracil** base can be incorporated into DNA opposite **adenines** in DNA.

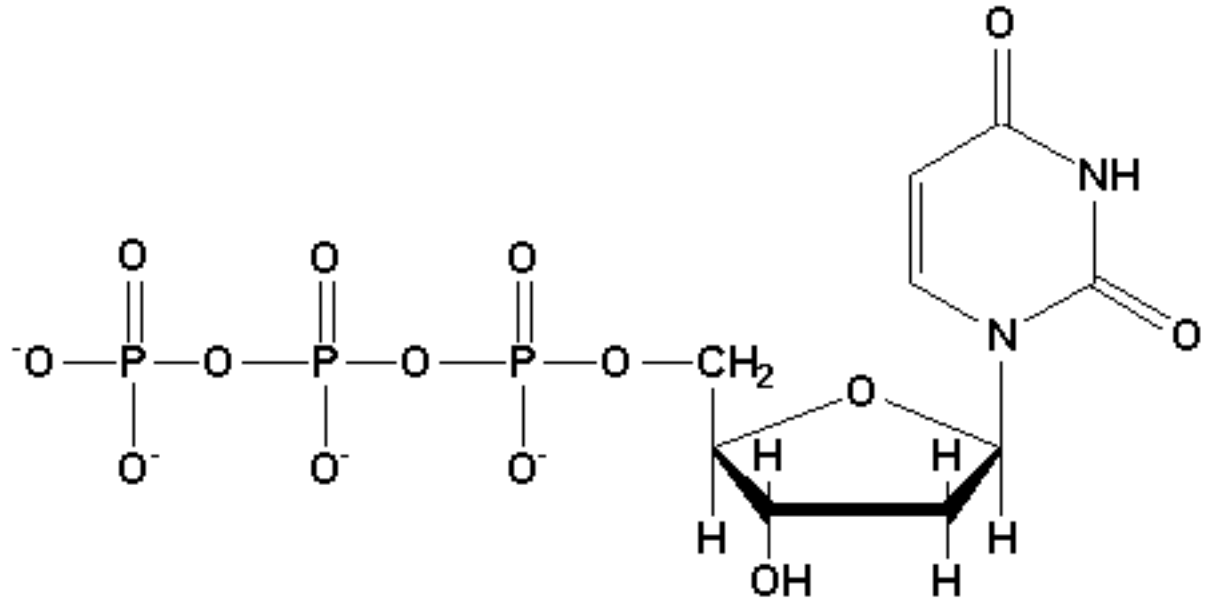

Deoxyuridine Triphosphate (UTP)

See also: [Deoxyuridine Nucleotide Metabolism](#)

Deoxyuridine Diphosphate (dUDP)

dUDP is a deoxyribonucleotide made from UDP in the reaction catalyzed by **ribonucleotide reductase**, as follows:



Phosphorylation of **dUDP** yields **dUTP**. dUTP is quickly cleaved in cells by **dUTPase** to yield **dUMP**. This reaction is part of the *de novo* synthetic pathway for **dTTP**.

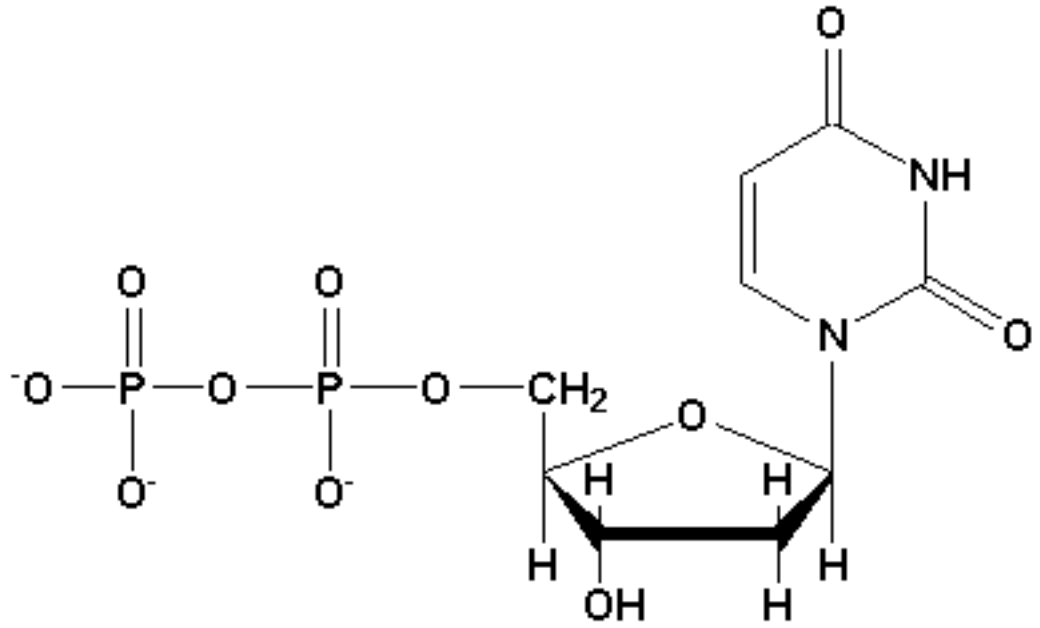

Deoxyuridine diphosphate (UDP)

See also: [Nucleotides](#), [Figure 22.17](#)

dUTPase

dUTPase is an enzyme of deoxyribonucleotide metabolism that converts dUTP to dUMP, as follows:

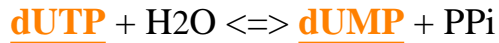

This reaction is part of the *de novo* biosynthetic pathway leading to **dTTP** ([Figure 22.17](#)). In addition, the enzyme has the important effect of lowering the concentration of **dUTP** in the cell. dUTP can be incorporated by DNA polymerase into DNA in place of dTTP. This can be problematic, because deamination of the **uracil** base converts it to **cytosine**. If this happens in DNA, a mutation will result.

See also: [Ribonucleotide Reductase and Deoxyribonucleotide Biosynthesis](#), [Biosynthesis of Thymine Deoxyribonucleotides](#), [Deoxyuridine Nucleotide Metabolism](#)

INTERNET LINK: [Pyrimidine Metabolism](#)

Deoxyuridine Monophosphate (dUMP)

dUMP is a deoxyribonucleotide intermediate in synthesis of **dTTP** ([Figure 22.17](#)). **dUMP** is produced from **dUTP** by **dUTPase**. **dUMP** is subsequently converted to **dTMP** by the enzyme **thymidylate synthase**.

See also: [Nucleotides](#), [Pathways in Nucleotide Metabolism](#)

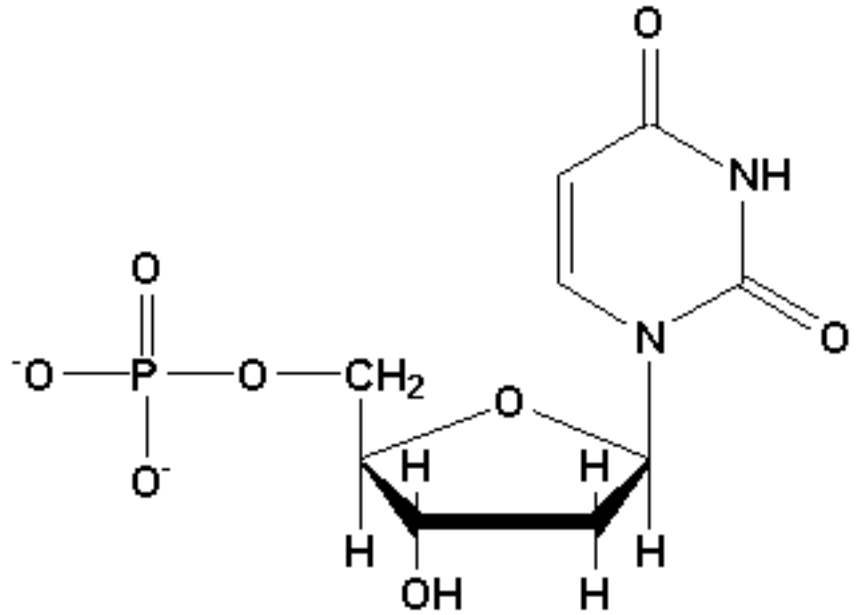

Deoxyuridine Monophosphate (dUMP)

Thymidylate Synthase



Thymidylate synthase is an enzyme that catalyzes the reaction that follows ([Figure 22.18](#)):



The reaction is part of the *de novo* synthesis pathway of dTMP.

5-Fluorodeoxyuridine monophosphate ([FdUMP](#)) is a molecule that is a mechanism-based inhibitor. Irreversible binding of FdUMP to **thymidylate synthase** occurs only in the presence of 5,10-methylenetetrahydrofolate. Crystallographic analysis of **thymidylate synthase** with dUMP and an analog of 5,10-methylenetetrahydrofolate (that could not be acted on by the enzyme) reveals that **thymidylate synthase** normally makes a transient covalent bond in the process of catalysis of the reaction. Apparently FdUMP's structure traps the enzyme-substrate covalent bond and prevents it from breaking down.

See also: [De Novo Pyrimidine Nucleotide Metabolism](#), [Figure 22.17](#), [Drug Design](#)

5,10-Methylenetetrahydrofolate

5,10-Methylenetetrahydrofolate is a donor of single-carbon units. **5,10-Methylenetetrahydrofolate** can be made from tetrahydrofolate as follows:

Glycine +
Tetrahydrofolate + **NAD⁺** -
> **5,10-Methylenetetrahydrofolate**
+ CO₂ + NH₃ + **NADH** + H⁺

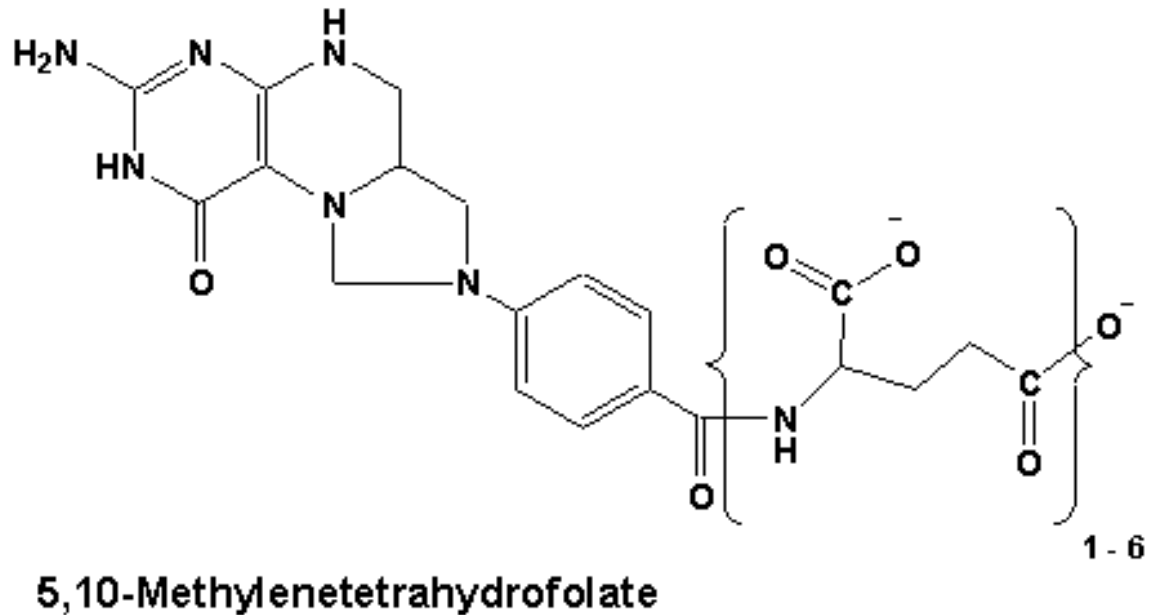

5-Fluorodeoxyuridine monophosphate (**FdUMP**) is a molecule that is a mechanism-based inhibitor. Irreversible binding of the substance to **thymidylate synthase** occurs only in the presence of **5,10-methylenetetrahydrofolate**, a cofactor for the reaction catalyzed by thymidylate synthase (**Figure 22.18**). Crystallographic analysis of thymidylate synthase with **dUMP** and an analog of **5,10-methylenetetrahydrofolate** (that could not be acted on by the enzyme) revealed that thymidylate synthase normally makes a transient covalent bond in the process of catalysis of the reaction. Apparently FdUMP's structure traps the enzyme-substrate covalent bond and prevents it from breaking down.

See also: [De Novo Biosynthesis of Purine Nucleotides](#), [DHF](#), [THF](#), [10-Formyltetrahydrofolate](#), [S-Adenosylmethionine and Biological Methylation](#), [Metabolism of Serine, Glycine, and Threonine](#), [Dihydrofolate Reductase](#), [FdUMP](#), [Vitamin B12 Coenzymes](#)

INTERNET LINK: [One Carbon Pool by Folate](#)

5,6,7,8-Tetrahydrofolate (THF)

THF is a folate derivative with a role in *de novo* synthesis of purines ([Figure 22.4](#)) and **dTMP** ([Figure 22.18](#))

Dihydrofolate reductase catalyzes the conversion of **dihydrofolate** (DHF) to **THF**. This reaction is essential for the recycling of DHF to **5,10-methylenetetrahydrofolate** for use by **thymidylate synthase** in *de novo* synthesis of dTMP. Inhibitors of dihydrofolate reductase, such as **methotrexate** and **trimethoprim**, ultimately inhibit production of dTTP.

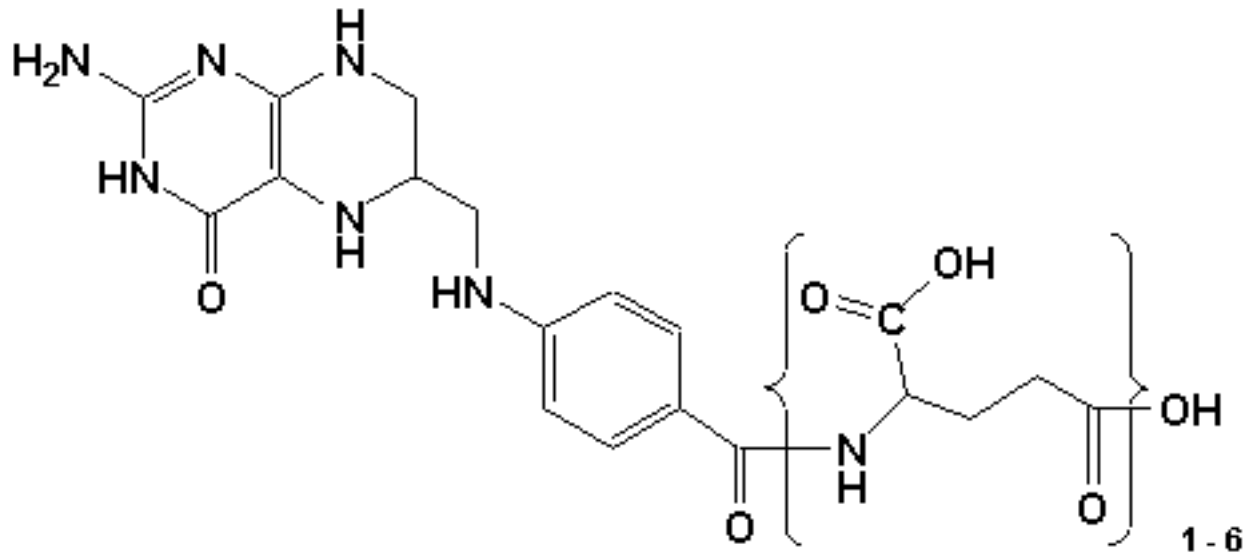

5,6,7,8-Tetrahydrofolate

THF and 5,10-methylenetetrahydrofolate can also be interconverted by the glycine catabolic reaction below



See also: [De Novo Biosynthesis of Purine Nucleotides](#), [DHF](#), [N-10-Formyltetrahydrofolate](#), [5,10-Methylenetetrahydrofolate](#)

INTERNET LINK: [One Carbon Pool by Folate](#)

Dihydrofolate Reductase

Dihydrofolate Reductase - [Figure 22.18](#) illustrates the important role of [dihydrofolate reductase](#) in the pathways regenerating tetrahydrofolate from the dihydrofolate generated in the synthesis of [dTMP](#) from [dUMP](#). Inhibitors of **dihydrofolate reductase**, such as [methotrexate](#) and trimethoprim, ultimately inhibit production of [dTTP](#).

See also: [De Novo Biosynthesis of Purine Nucleotides](#), [Tetrahydrofolate Coenzymes](#), [DHF](#), [THF](#), [5,10-Methylene THF](#), [Nucleotide Analogs in Medicine](#), [Gene Amplification](#)

INTERNET LINK:

1. [DHFR, The Movie](#)
 2. [One Carbon Pool by Folate](#)
-

Methotrexate (Amethopterin) (4-Amino-10-Methylfolate)

Methotrexate is an inhibitor of the enzyme **dihydrofolate reductase** and is used in the treatment of diseases. Inhibition of dihydrofolate reductase by methotrexate shuts down *de novo* biosynthesis of **dTMP** (**Figure 22.18**), because when the enzyme is inhibited, dihydrofolate (**DHF**) cannot be converted back to **5,10-Methylene THF**, an essential intermediate in the *de novo* synthetic pathway.

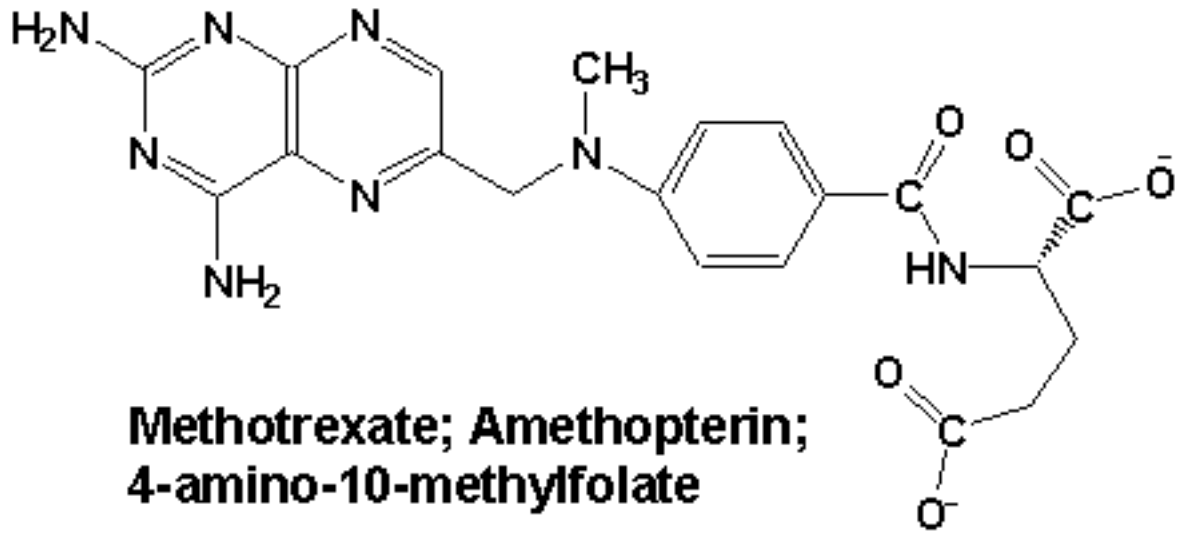

See also: [De Novo Biosynthesis of Purine Nucleotides](#), [Tetrahydrofolate Coenzymes](#), [Nucleotide Analogs in Medicine](#), [Trimethoprim](#), [Biosynthesis of Thymine Deoxyribonucleotides](#)

INTERNET LINK: [One Carbon Pool by Folate](#)

7,8-Dihydrofolate (DHF)

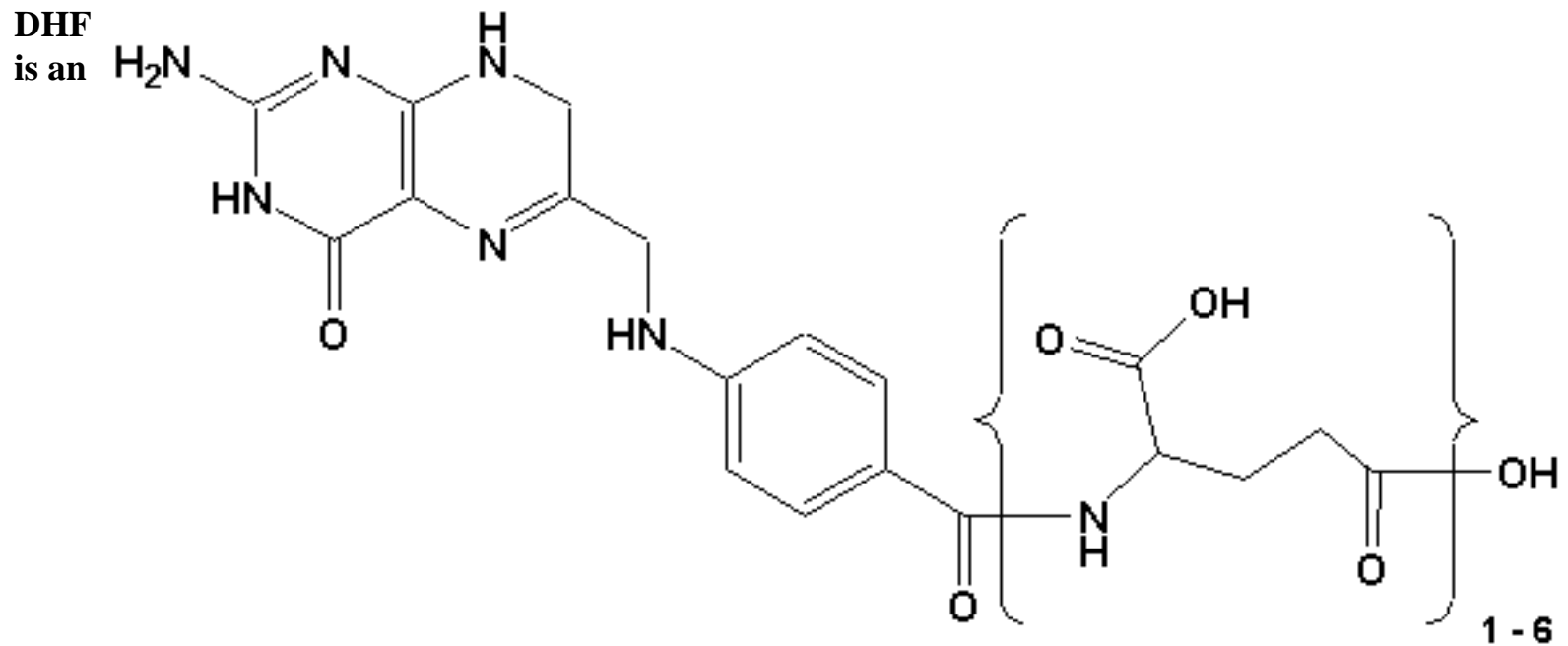

7,8-Dihydrofolate (DHF)

important intermediate in *de novo* synthesis of [dTTP](#). DHF is produced from [5,10-methylene THF](#) in the conversion of [dUMP](#) to [dTMP](#) catalyzed by [thymidylate synthase](#) ([Figure 22.18](#)). Subsequently, 5,10-methylene-THF must be regenerated from DHF (catalyzed by [dihydrofolate reductase](#)) in order for *de novo* dTMP synthesis to occur. Inhibitors of dihydrofolate reductase, such as [methotrexate](#) and [trimethoprim](#), ultimately inhibit *de novo* production of dTTP.

See also: [De Novo Biosynthesis of Purine Nucleotides](#), [Tetrahydrofolate Coenzymes](#)

INTERNET LINK: [One Carbon Pool by Folate](#)

5-Fluorodeoxyuridine Monophosphate (FdUMP)

5-Fluorodeoxyuridine monophosphate (FdUMP)

is a molecule that is a mechanism-based inhibitor. Irreversible binding of **FdUMP** to [thymidylate synthase](#) occurs only in the presence of [5,10-](#)

[methylenetetrahydrofolate](#),

a cofactor for the reaction catalyzed by thymidylate synthase ([Figure 22.18](#)).

Crystallographic analysis of thymidylate synthase with [dUMP](#) and an analog of

5,10-methylenetetrahydrofolate (that could not be acted on by the enzyme) revealed that thymidylate synthase normally makes a transient covalent bond in the process of catalysis of the reaction. Apparently **FdUMP**'s structure traps the enzyme-substrate covalent bond in the reaction intermediate and prevents it from breaking down, thereby halting the enzyme from acting.

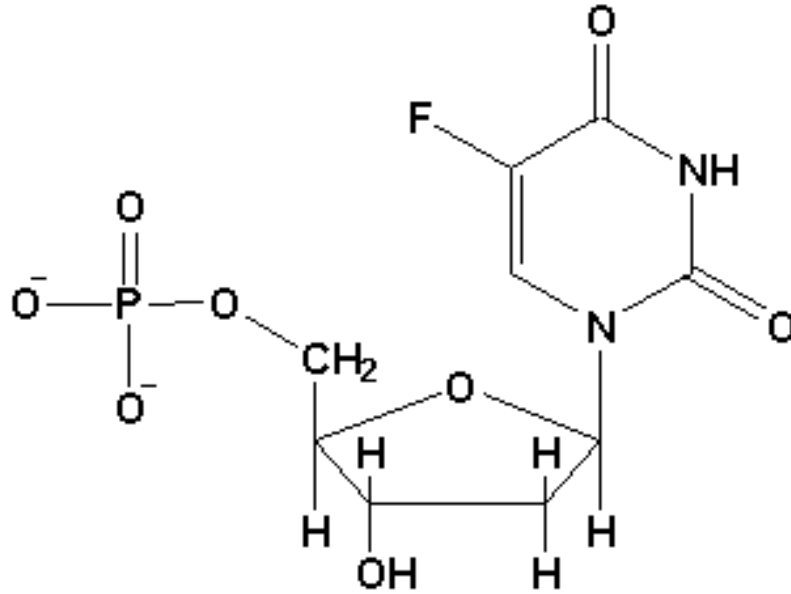

5-Fluorodeoxyuridine Monophosphate (FdUMP)

See also: [Drug Design](#)

Drug Design

The goal of chemotherapy is to exploit a biochemical difference between the disease process and the host tissue in order to interfere selectively with the disease process. Knowledge from x-ray crystallographic analysis of enzymes and molecular modeling with modern computer software allows scientists to design drugs that fit into important, specific regions of enzymes (such as the active site) and inactivate them.

5-Fluorodeoxyuridine monophosphate (**FdUMP**) is a mechanism-based inhibitor. Irreversible binding of the substance to **thymidylate synthase** occurs only in the presence of **5,10-methylenetetrahydrofolate**, a cofactor for the reaction catalyzed by thymidylate synthase (**Figure 22.18**). Crystallographic analysis of thymidylate synthase with **dUMP** and an analog of 5,10-methylenetetrahydrofolate (that could not be acted on by the enzyme) revealed that thymidylate synthase normally makes a transient covalent bond in the process of catalyzing the reaction. Apparently the structure of FdUMP is similar enough to dUMP to form the covalent bond with the enzyme, but different enough that the covalent bond doesn't break down again. Thus, the enzyme is trapped in a form that cannot react with dUMP; its intended substrate traps the enzyme-substrate covalent bond and prevents it from breaking down.

Unfortunately, the **5-fluorouracil** used to make FdUMP can be incorporated into RNA by salvage routes normally used for uracil, thereby interfering with the function of **messenger RNA** in both cancer and normal cells. As a result, molecular modeling is currently being employed to design coenzymes that replace 5,10-methylenetetrahydrofolate and cause dUMP's transient covalent bond to become trapped during catalysis.

See also: [Nucleotide Analogs in Medicine](#)

5-Fluorouracil

5-Fluorouracil is a base analog of [uracil](#) that is converted to 5-fluorodeoxyuridine monophosphate ([FdUMP](#)) in cells. FdUMP is a mechanism-based inhibitor that irreversibly binds to the enzyme [thymidylate synthase](#) only in the presence of [5,10-methylenetetrahydrofolate](#).

See also: [Drug Design](#)

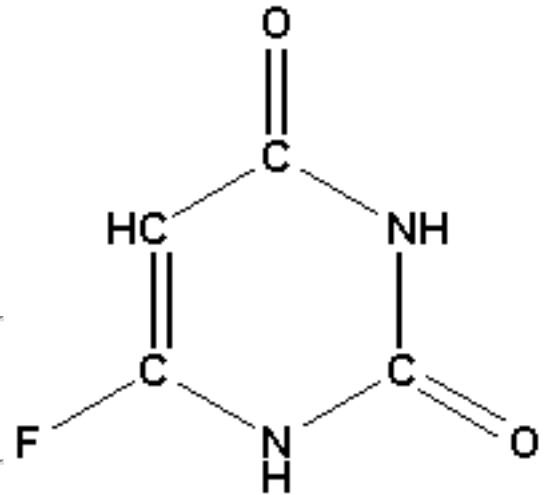

Fluorouracil

Nucleotide Analogs in Medicine

DNA polymerases and/or nucleotide metabolism enzymes are the targets of "designer" drugs. Target enzymes include the following:

Deoxypyrimidine kinase of herpesvirus - This viral enzyme readily phosphorylates the drugs **5-iododeoxyuridine**, acycloguanosine (**acyclovir**), and **ganciclovir**. The viral DNA polymerase attempts, in turn, to incorporate them into DNA in place of the corresponding dNTP. All three of the triphosphates of these drugs interfere with DNA replication. Uninfected cells do not efficiently phosphorylate acyclovir and ganciclovir and they phosphorylate 5-iododeoxyuridine only weakly, so DNA replication and virus growth are inhibited selectively in infected cells.

DNA polymerases - Arabinosyladenine (**araA**) and arabinosylcytosine (**araC**) are readily converted to triphosphates (araATP and araCTP). AraATP is a selective inhibitor of the DNA polymerases of herpesvirus. araC is used in chemotherapy and functions by the same mechanism of inhibition on the cellular polymerase.

Reverse Transcriptase - 3'-Azido-2'3'-dideoxythymidine (**AZT**), when converted to the corresponding 5' triphosphate in cells, is an inhibitor of the HIV reverse transcriptase enzyme, which is responsible for making viral DNA from viral RNA. Other nucleoside analogs, such as 2'3'-dideoxycytidine (**ddC**), 2'3'-dideoxyinosine (**ddI**), and 2'3'-dideoxy-3'-deoxythymidine (d4T) (see **here**) are also converted to triphosphates and act by blocking DNA chain elongation after they are incorporated into DNA.

Purine salvage enzymes - The drugs allopurinol (see **here**) and formycin B inhibit the action of cellular purine salvage enzymes. Thus, these drugs can be used to treat individuals infected by the parasitic protozoans, *Plasmodium*, and *Leishmania* because these parasites lack the capacity for **de novo purine synthesis** (i.e., they depend entirely upon cellular purine salvage enzymes and bases provided by the host)

Dihydrofolate reductase - **Figure 22.18** illustrates the important role of dihydrofolate reductase in the pathways regenerating **tetrahydrofolate** from the **dihydrofolate** generated in the synthesis of **dTMP** from **dUMP**. Inhibitors of dihydrofolate reductase, such as **methotrexate** and **trimethoprim**, ultimately inhibit production of **dTTP**.

See also: **Drug Design**, **Salvage Routes to Deoxyribonucleotide Synthesis**, **DNA Replication Overview** (from Chapter 24), **Eukaryotic DNA Polymerases** (from Chapter 24), **Retrovirus Replication** (from Chapter 24)

Deoxypyrimidine Kinase

Deoxypyrimidine kinase is a pyrimidine salvage pathway enzyme in herpesvirus and is a target for antiviral drugs. Its normal substrates are **thymidine** and **dTMP**. The enzyme readily phosphorylates the drugs **5-iododeoxyuridine**, acycloguanosine (**acyclovir**), and **ganciclovir**. When the viral DNA polymerase attempts, in turn, to incorporate them into DNA in place of the corresponding dNTPs all three of the triphosphates of these drugs interfere with DNA replication. Uninfected cells do not efficiently phosphorylate acyclovir and ganciclovir and they phosphorylate 5-iododeoxyuridine only weakly, so DNA replication and virus growth are inhibited selectively in infected cells.

See also: [Nucleotide Analogs in Medicine](#), [Nucleotide Salvage Synthesis](#), [Salvage Routes to Deoxyribonucleotide Synthesis](#)

5-Iododeoxyuridine

5-Iododeoxyuridine is a derivative of uridine used to combat herpesvirus. The viral enzyme, **deoxypyrimidine kinase**, readily phosphorylates **5-iododeoxyuridine** and the viral DNA polymerase attempts, in turn, to incorporate them into DNA in place of the corresponding dNTP. The drug interferes with DNA replication. Uninfected cells phosphorylate **5-iododeoxyuridine** only weakly, so DNA replication and virus growth are inhibited selectively in infected cells.

See also: [Nucleotide Analogs in Medicine](#)

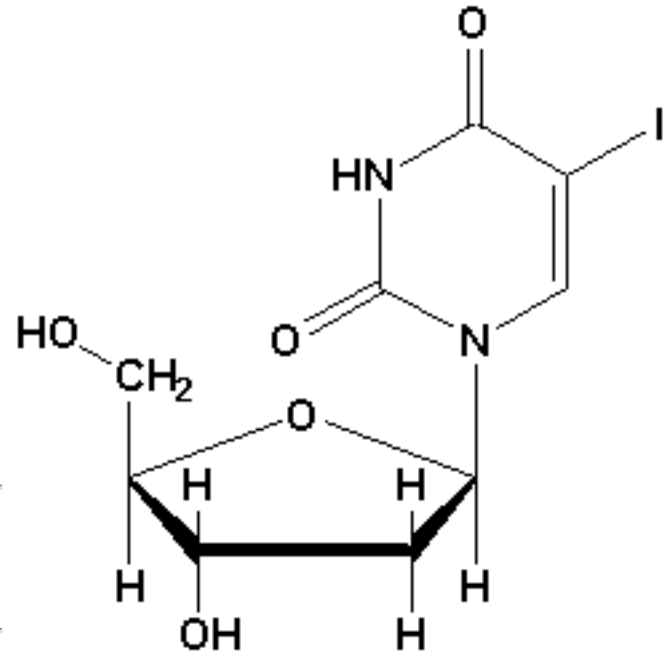

5-Iododeoxyuridine

Acyclovir (Acycloguanosine)

Acyclovir is an antiviral drug used to treat herpesvirus infection. The basis of its action is that **acyclovir** resembles part of the **guanosine** nucleoside and is phosphorylated by the viral enzyme, **deoxythymidine kinase**. The phosphorylated triphosphate form of **acyclovir** is an inhibitor of the herpesvirus DNA polymerase. A related compound, **ganciclovir**, works similarly. Uninfected cells do not efficiently phosphorylate **acyclovir** and **ganciclovir**, so DNA replication and virus growth are inhibited selectively in infected cells.

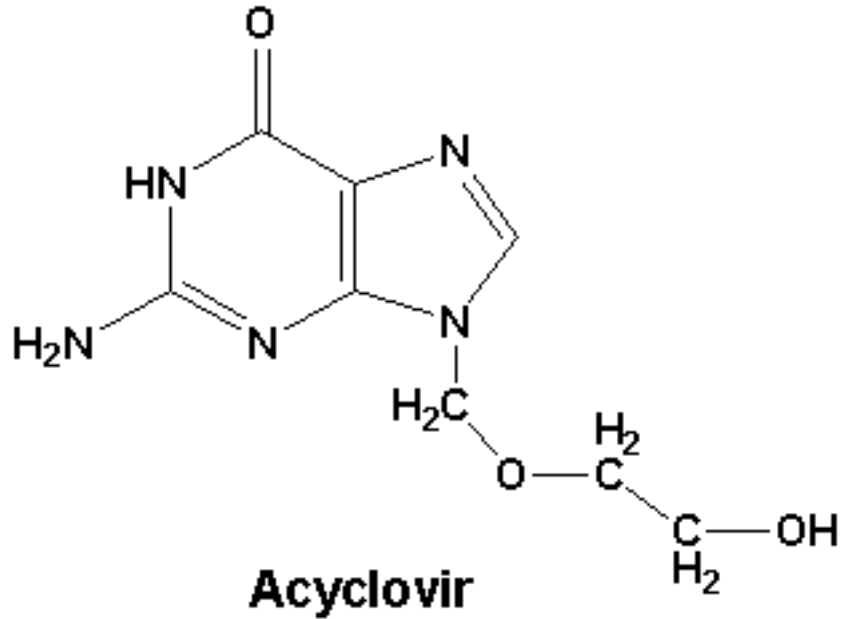

See also: [Nucleotide Analogs in Medicine](#), [Nucleotide Salvage Synthesis](#), [Salvage Routes to Deoxyribonucleotide Synthesis](#)

Ganciclovir

Ganciclovir is an antiviral drug used to treat herpesvirus infection. The basis of its action is that **ganciclovir** resembles part of the **guanosine** nucleoside and is phosphorylated by the viral enzyme, **deoxythymidine kinase**. The phosphorylated triphosphate form of **ganciclovir** is an inhibitor of the herpesvirus DNA polymerase. A related compound, **acyclovir**, works similarly. Uninfected cells do not efficiently phosphorylate **ganciclovir** and acyclovir, so DNA replication and virus growth are inhibited selectively in infected cells.

See also: [Nucleotide Analogs in Medicine](#), [Nucleotide Salvage Synthesis](#), [Salvage Routes to Deoxyribonucleotide Synthesis](#)

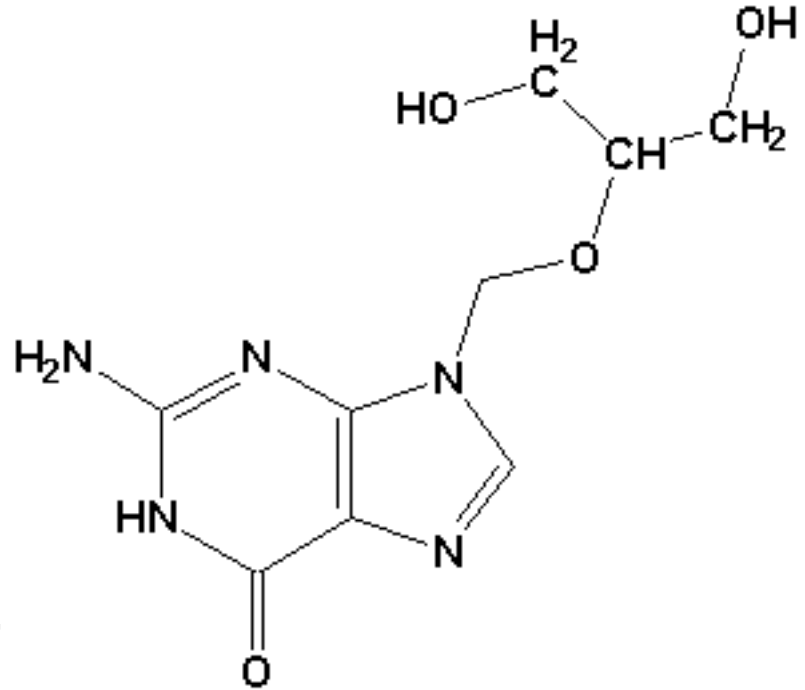

Ganciclovir

Arabinosyladenine (araA)

araA is an arabinosyl derivative of adenosine that is used to combat herpesviruses. The compound is readily taken up by cells and converted to the triphosphate form (**araATP**). AraATP is an inhibitor of the DNA polymerases of herpesvirus. A related compound, **araC** is used in chemotherapy and functions by the same mechanism of inhibition on the cellular polymerase.

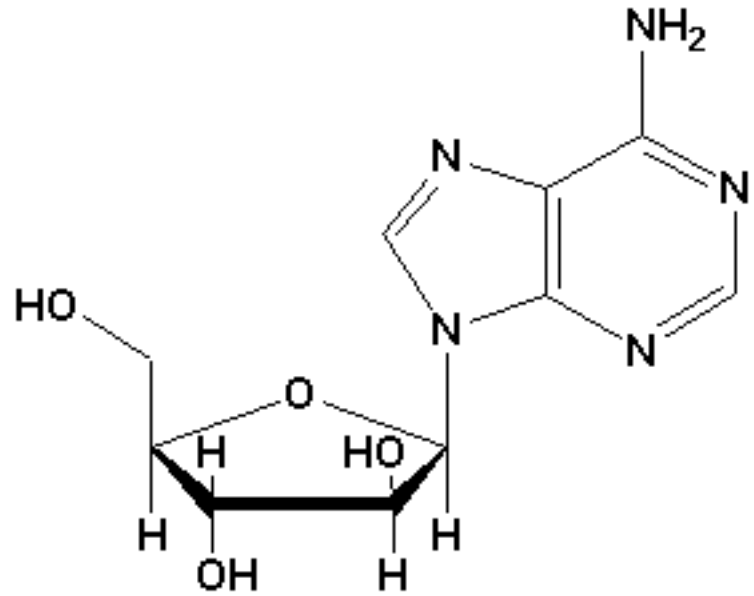

Arabinosyladenine

See also: [Nucleotide Analogs in Medicine](#), [Adenosine](#)

Arabinosyladenine Triphosphate (araATP)

araATP is a triphosphate derivative of arabinosyladenine (**araC**). **araA** is used to combat herpesviruses. The compound is readily taken up by cells and converted to the triphosphate form (**araATP**).

araATP is an inhibitor of the DNA polymerases of herpesvirus.

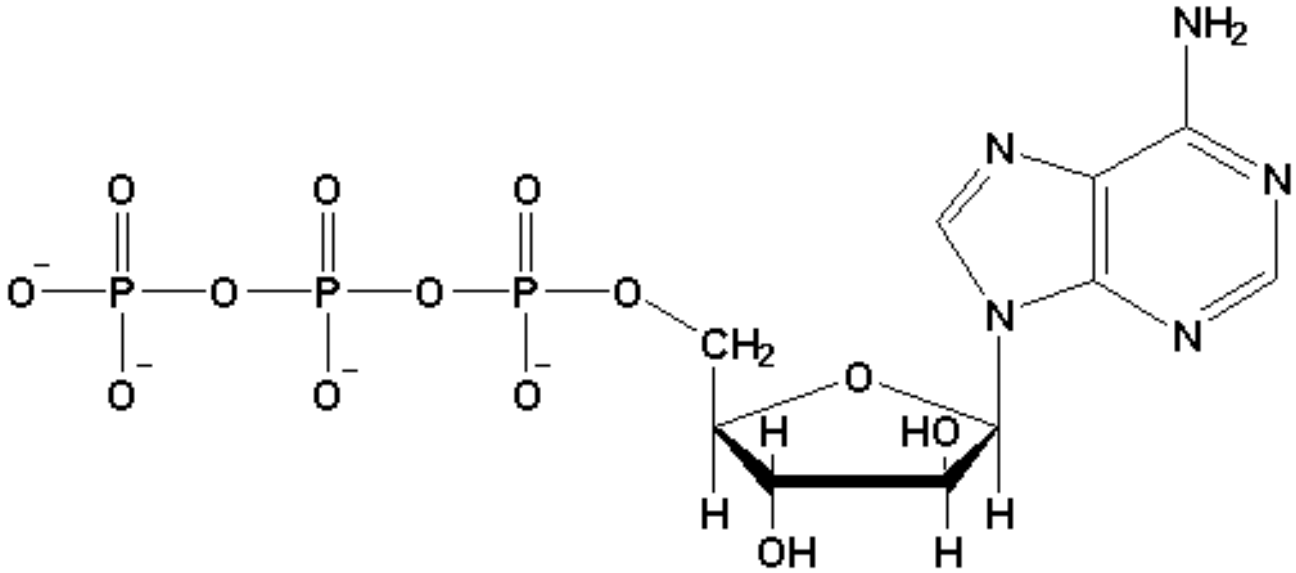

Arabinosyladenine triphosphate (araATP)

See also: [Nucleotide Analogs in Medicine](#), [Adenosine](#), [araC](#)

Arabinosylcytosine (araC)

araC is an arabinosyl derivative of **cytosine** that is used in chemotherapy. The compound is readily taken up by cells and converted to the triphosphate form (**araCTP**). AraCTP is an inhibitor of the cellular DNA polymerase. A related compound, **araA** is used to combat herpesviruses and functions by the same mechanism of inhibition on the herpesvirus DNA polymerase.

See also: [Nucleotide Analogs in Medicine](#), [Adenosine](#), [araC](#)

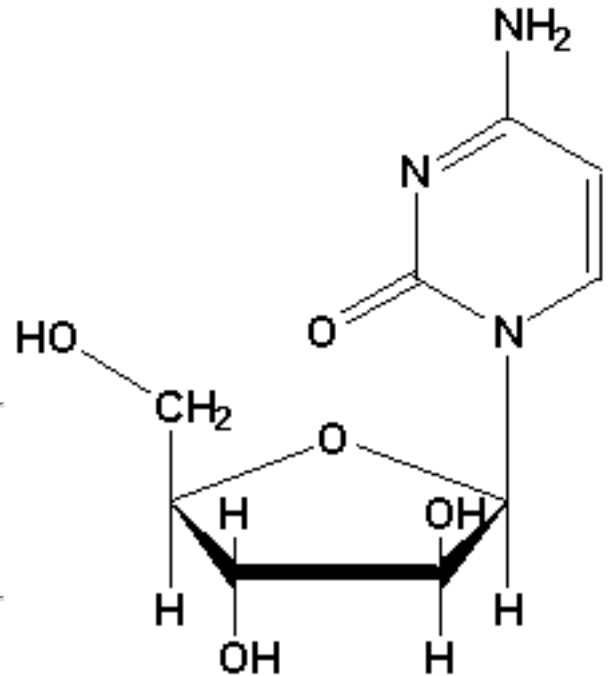

Arabinosylcytosine (araC)

Arabinosylcytosine Triphosphate (araCTP)

araCTP is a triphosphate derivative of arabinosyladenine (**araC**). **araA** is used to combat herpesviruses. The compound is readily taken up by cells and converted to the triphosphate form (**araCTP**). **araCTP** is an inhibitor of the DNA polymerases.

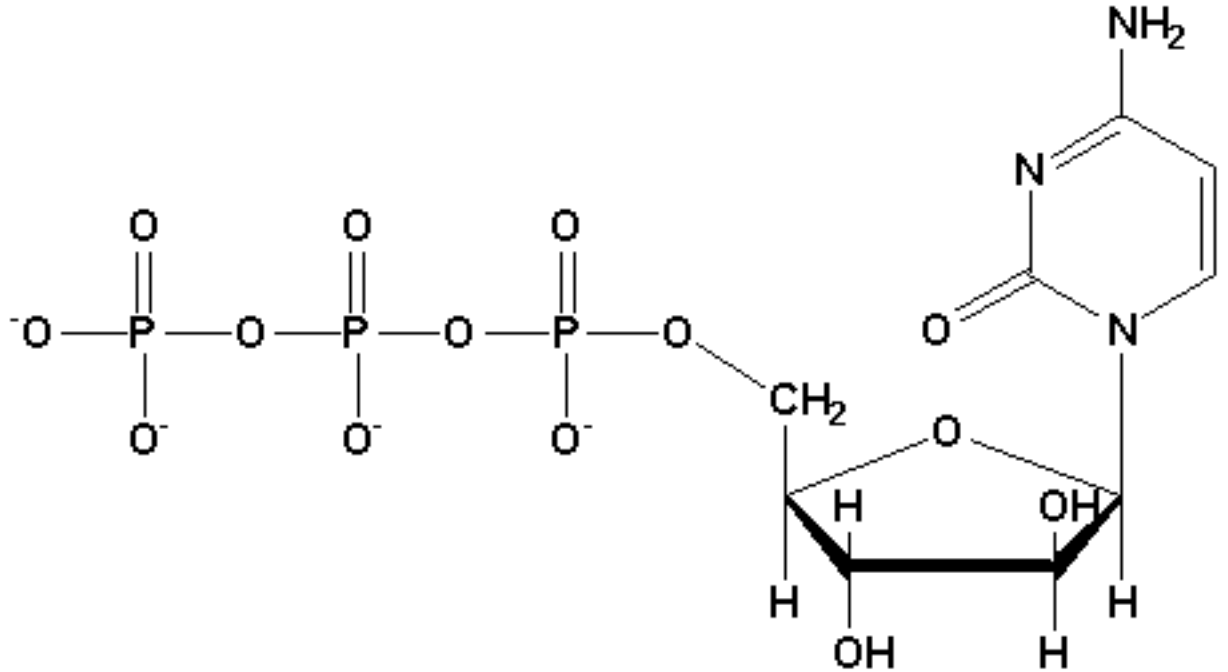

See also: [Nucleotide](#)
[Analogues in Medicine](#), [Adenosine](#), [araC](#)

Arabinosylcytosine Triphosphate (araCTP)

Reverse Transcriptase

Reverse transcriptase is an RNA-directed DNA polymerase common in retroviruses. The HIV retrovirus that causes AIDS contains a **reverse transcriptase**. Like other RNA-dependent polymerases, **reverse transcriptase** is very error prone because it contains no proofreading activity. The replication scheme of retroviral RNA is as follows:

1. Viral RNA in the host cell base pairs with a specific tRNA molecule to provide a primer for DNA replication.
2. Reverse transcriptase makes DNA towards the 5' end of the viral RNA.
3. RNase H partially degrades RNA from the RNA-DNA duplex, removing the 5' terminus.
4. The 3' terminus of the viral RNA base pairs with the overhanging DNA strand, forming a circle-like structure.
5. Reverse transcriptase makes a DNA copy of the entire genome, using the 3' end of the DNA strand as a primer.
6. The RNA strand of the duplex is removed and a DNA strand complementary to the first DNA strand is synthesized to form a duplex.
7. The duplex integrates into the host chromosome

The drug, 3'-Azido-2'-dideoxythymidine ([AZT](#)), when converted to the corresponding 5' triphosphate in cells, is an inhibitor of the HIV **reverse transcriptase** enzyme. Other nucleoside analogs, such as 2'-dideoxycytidine ([ddC](#)), 2'-dideoxyinosine ([ddI](#)), and 2'-dehydro-3'-deoxythymidine (d4T) (see [here](#)) are also converted to triphosphates and act by blocking DNA chain elongation after they are incorporated into DNA.

See also: [Retrovirus Replication](#), [RNA Viruses](#)

INTERNET LINKS:

1. [Reverse Transcriptase](#)

2. [HIV Insite](#)
 3. [General Replication Strategies for RNA Viruses](#)
 4. [A Multimedia AIDS and HIV Resource](#)
 5. [All the Virology on the WWW](#)
-

3'-Azido-2'-Dideoxythymidine (AZT)

AZT was the first drug approved in the United States for the treatment of HIV infections. This **nucleoside** is anabolized to the corresponding 5' triphosphate, which acts as an inhibitor of viral **reverse transcriptase** in making **DNA** from the viral **RNA**.

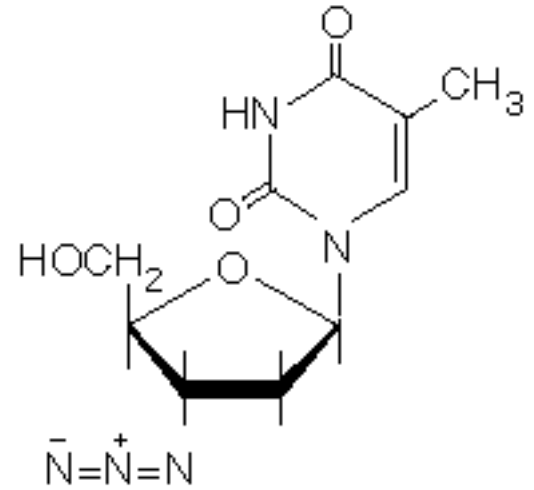

Other inhibitors of reverse transcriptase are shown [here](#).

See also: [Salvage Routes to Deoxyribonucleotide Synthesis](#), [Nucleotide Analogs in Medicine](#), [Thymidine Kinase](#)

DNA

DNA is an acronym for deoxyribonucleic acid. **DNA** is the genetic material and is a component of [chromosomes](#). It provides information for how to assemble [proteins](#) in the form of a code called the [genetic code](#).

See also: [Nucleotides](#), [Nucleic Acids](#), [RNA](#)

INTERNET LINK: [DNA Models](#) (motion)

Nucleic Acids



Nucleic acid is the general name for the macromolecules [RNA](#) and [DNA](#). They are each made up of a polymer of nucleotides with the 5' phosphate of each nucleotide forming a phosphodiester bond with the 3' hydroxyl of the adjacent one.

See also: [Nucleotides](#), [Nucleosides](#), [Macroions](#)

Macroions

Large polyelectrolytes, such as [nucleic acids](#), and polyampholytes, such as proteins, are classified together as **macroions**. The electrostatic forces of attraction or repulsion between such charged particles play a major role in determining their behavior in solution.

Each **macroion** collects about it (in solution) a counterion "atmosphere" ([Figure 2.22](#)) enriched in oppositely charged small ions. This cloud of ions tends to screen the molecules from one another.

See also: [Debye-Huckel Theory](#), [Polyelectrolytes](#), [Polyampholytes](#)

Figure 2.22: The influence of small ions on macroion interactions.

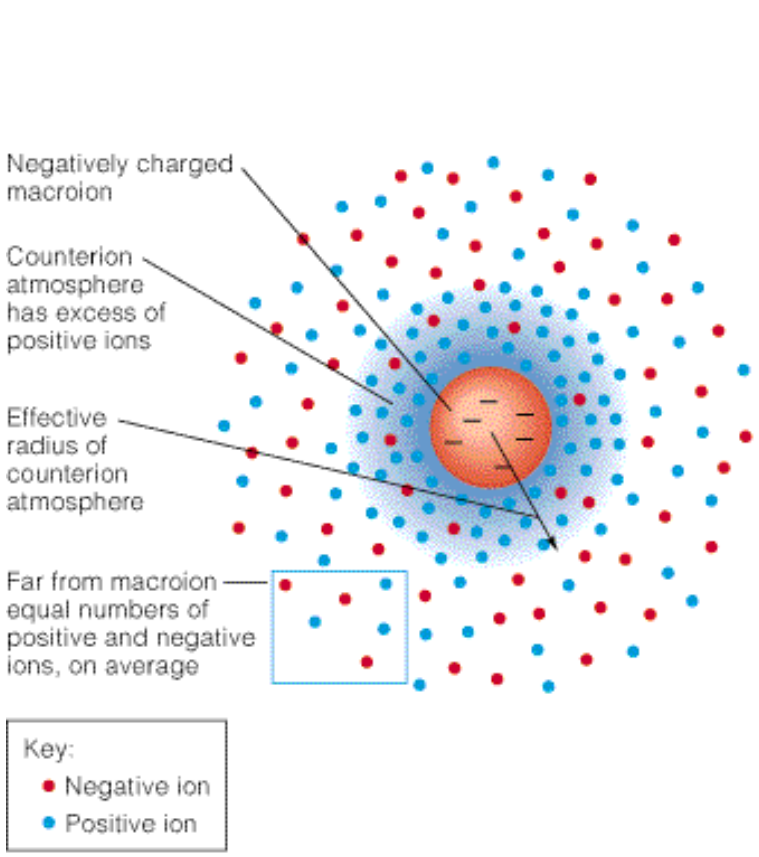

(a) The counterion atmosphere

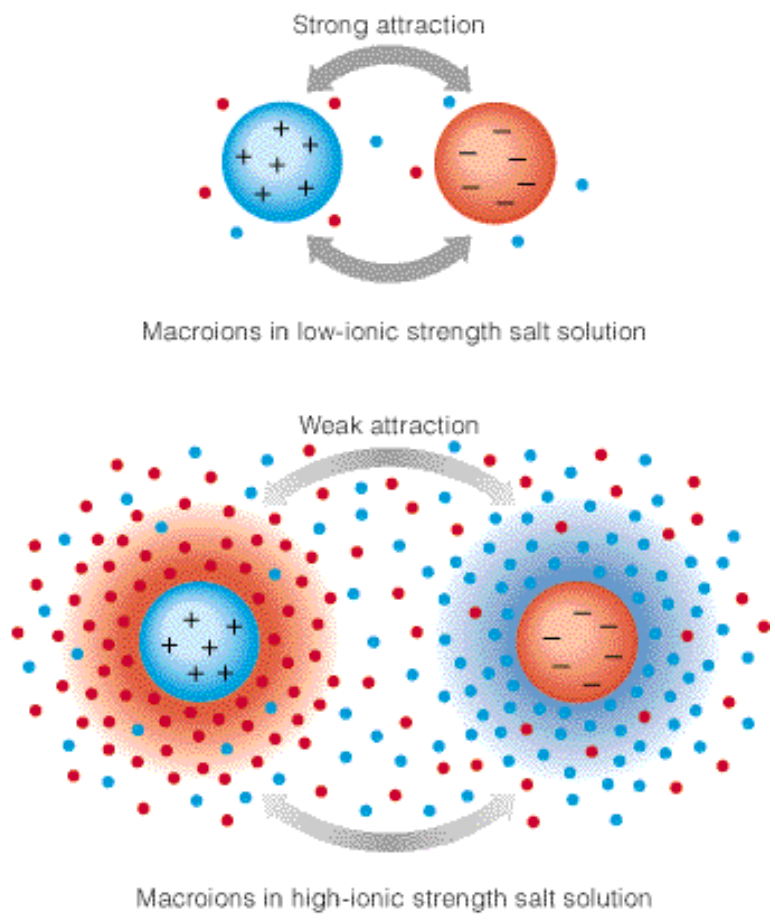

(b) The influence of ionic strength

Debye-Huckel Theory

Debye-Huckel Theory - Polyampholytes like proteins or polyelectrolytes like DNA are called macroions because they are large and because, depending on the solution pH, they may carry a substantial net charge.

As shown in [Figure 2.22a](#), each macroion collects about it a counterion atmosphere of oppositely charged small ions. These small ions, such as Mg^{2+} and Cl^- , are called counterions and they interact with macroions by charge-charge interactions. The counterion atmosphere shields macroions from each other, thus diminishing their ability to interact on the basis of charge.

The thickness of the counterion atmosphere depends on the concentration of counterions present in the solution. the greater the concentration of counterions, the thicker the counterion atmosphere, and the more effective is the electrostatic screening between individual macroions (See [Figure 2.22b](#)) The amount of counterions in solution is measured as the ionic strength, I.

$$I = \frac{1}{2} \sum_i M_i Z_i^2 \quad (2.23)$$

where i is the number of different counterions in the solution, M_i is the molarity of each counterion 'i', and Z_i is the charge of counterion 'i'.

Debye-Huckel theory attempts to measure the radius across which macroions can interact with each other:

$$r = \frac{K}{I^{1/2}} \quad (2.22)$$

,where K is a constant.

The larger 'r' is, the longer the distance two macroions can affect each other. Thus, as the ionic strength (concentration) increases, the smaller the radius with which macroions can influence each other. Another way to say this is that as 'r' gets smaller, macroions must be closer together before they can interact with each other, due to the shielding or shell of the counterions.

See also: [DNA](#), [Dielectric Constant](#), [Ionic Equilibria and pH](#)

Dielectric Constant

Coulomb's law, $F = k \cdot (q_1 q_2) / r^2$ describes the force between two charges (q_1 and q_2) separated by a distance r in a vacuum (k is a constant). When q_1 and q_2 are both positive or both negative, the force is positive and repulsive. When one charge is positive and the other is negative, the force is negative and attractive. In biological systems, charges are separated by water, other molecules, or parts of molecules, not a vacuum. Thus, the cellular medium shields charges from each other.

To account for solvent shielding, a dimensionless number called the **dielectric constant**, ϵ , is inserted into the Coulomb equation, $F = k \cdot (q_1 q_2) / (\epsilon \cdot r^2)$. The dielectric constant is high for a polar solvent and low for nonpolar organic solvents.

See also: [Coulomb's Law](#), [Covalent Bonds vs Non-Covalent Forces](#), [Hydrogen Bonds](#)

Coulomb's Law

Coulomb's law defines the force between a pair of charges (q_1 and q_2) separated by a vacuum by a distance, r as

$$F = k \cdot (q_1 q_2) / r^2,$$

where k is a constant.

When q_1 and q_2 have the same charge, the force is positive. This corresponds to a repulsive force.

When one charge is positive and the other is negative, the sign of the force is negative. This corresponds to an attractive force.

Such an attractive force holds crystals of sodium chloride together. Here sodium is positively charged and chloride is negatively charged.

See also: [Dielectric Medium](#), [Energy of Interaction](#)

Dielectric Medium

Coulomb's law defines the force, F , between charged particles q_1 and q_2 at a distance of ' r ' in a vacuum as

$F = k \cdot (q_1 q_2) / r^2$, where k is a constant.

To measure the same forces in a non-vacuum, **dielectric medium**, such as the aqueous environment of biological systems, the dielectric constant (ϵ) must be taken into account. The dielectric constant arises from the fact that the **dielectric medium** shields the charges from each other. This modifies Coulomb's law as follows:

$F = k \cdot (q_1 q_2) / (\epsilon \cdot r^2)$

Thus, the larger the value of ϵ , the smaller the force between the charges.

See also: [Energy of Interaction](#)

Energy of Interaction

The energy of interaction (U) is the energy required to separate two charged particles (q1 and q2) from a distance 'r' to an infinite distance. This is given by the equation

$$U = k \cdot (q_1 \cdot q_2) / (\epsilon \cdot r)$$

where k is a constant and ϵ is the dielectric constant of the medium

See also: [Dielectric Constant](#)

>The Clathrate Structure of Water

Hydrocarbons, which are nonpolar and nonionic and cannot form hydrogen bonds, show only limited solubility in water. However, energy is not the only consideration. When such hydrophobic ("water fearing") molecules do dissolve, they do not form hydration shells as hydrophilic substances do. Instead, the regular water lattice forms icelike **clathrate** structures, or "cages," about nonpolar molecules ([Figure 2.13](#)).

This ordering of water molecules corresponds to a decrease in the entropy, or randomness, of the mixture (see [here](#)). The decrease in entropy contributes to the low solubility of hydrophobic substances in water. It also accounts for the well-known tendency of hydrophilic substances to form aggregates in water - oil forms droplets when shaken with vinegar. Surrounding two hydrophobic molecules with two separate cages requires more ordering than surrounding them with a single cage, so the hydrophobic molecules tend to cluster.

See also: [Hydrogen Bonds](#), [Structure and Properties of Water](#), [Entropy](#)

Polyelectrolytes

Macromolecules, such as polylysine (see [here](#)), carry multiples of only positive or negative charge. Such molecules are called **polyelectrolytes**. They have many like charges to be in close proximity and this causes the pKa of each group to be influenced by the state of ionization of the others - widening the range of ionization beyond that of the simple range of a single such group. In a molecule like polylysine, the first protons are more easily removed than the last, because the strong positive charge on the fully protonated molecule helps drive protons away.

Nucleic acids are **polyelectrolytes** (negatively charged) and are ionized over a wide pH range for the reason given above.

See also: [Ampholytes](#), [Polyampholytes](#), [pKa](#), [Nucleic Acids](#)

Unnumbered Item

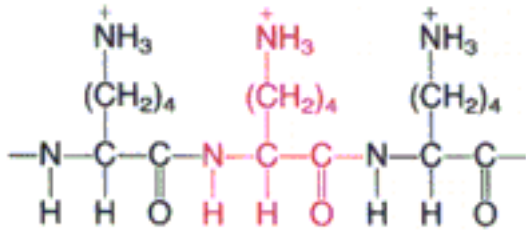

Polylysine

Ampholytes

Ampholytes are molecules containing both acidic and basic groups.

All of the common amino acids found in proteins ([Figure 5.3](#)) are **ampholytes** because they contain a carboxyl group (-COOH) that acts as an acid and an amino group (-NH₂) that acts as a base.

As free amino acids, each amino acid has at least two pK_a values (some have more because they have additional acidic or basic groups).

The titration of an **ampholyte** generates a more complex plot of pH versus moles of acid (or base) added than are obtained for a simple buffer with only a single ionizing species because the ionization of each acidic and basic group of the ampholyte is represented by a step in the titration curve. In [Figure 2.18](#), for example, there are two steps in the titration curve of the ampholyte glycine, whereas in [Figure 2.17](#) the titration curves of NH₄⁺ and HCOOH have only one step each. [Figure 2.19](#) shows the fraction of each molecular species of glycine present in the solution as a function of pH.

The presence of both acidic and basic groups in a single molecule means the molecule may exist in several different charged states. For example, glycine can have a charge of +1, 0, or -1, depending on the pH of the solution in which it is dissolved. The state at a net charge of zero arises when the basic amine group is charged +1 and the acidic carboxyl group is charged -1.

Molecules containing a mixture of charges that result in the molecule having an overall charge of 0 are

called Zwitterions. The zwitterion form of the amino acid, [glycine](#), is as follows:

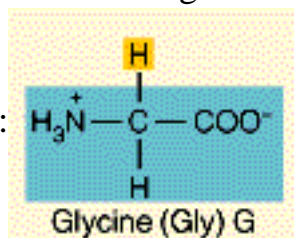

See also: [Ionic Equilibria and pH](#), [Henderson-Hasselbalch Equation](#), [pI](#), [Zwitterions](#)

Figure 2.18: Titration of the ampholyte glycine.

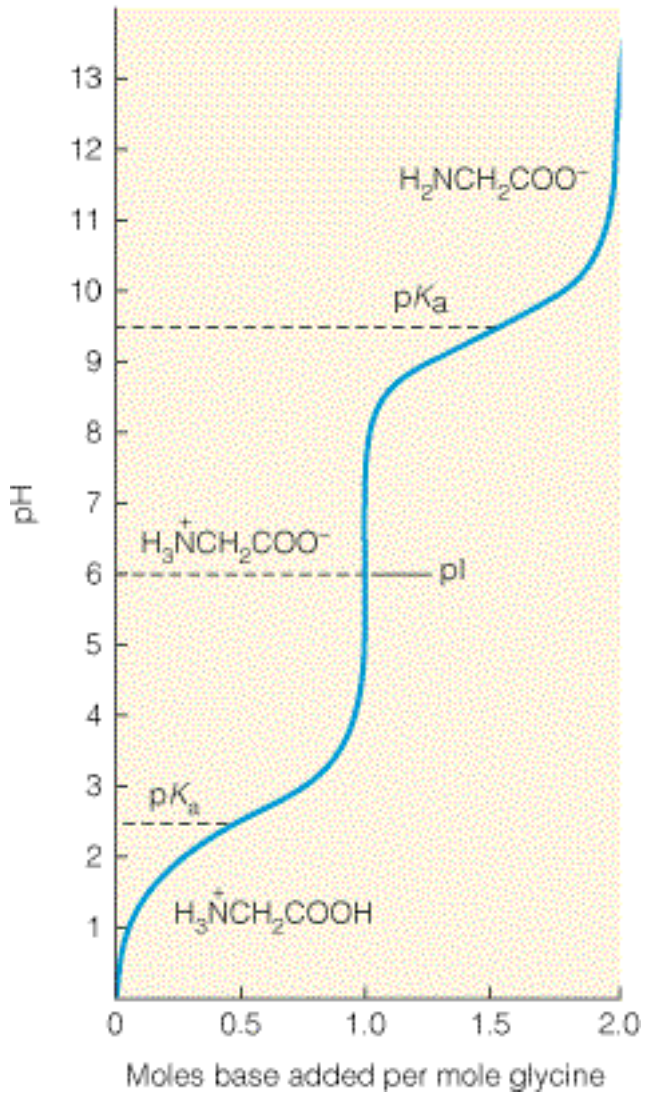

Figure 2.17: Titration curves of weak acids.

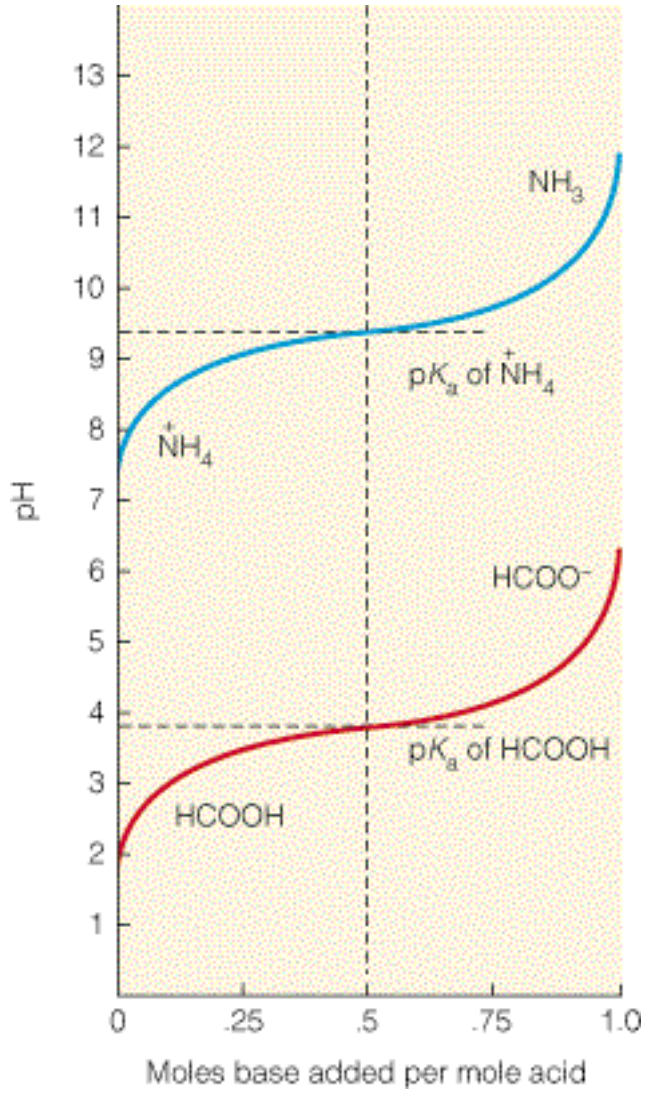
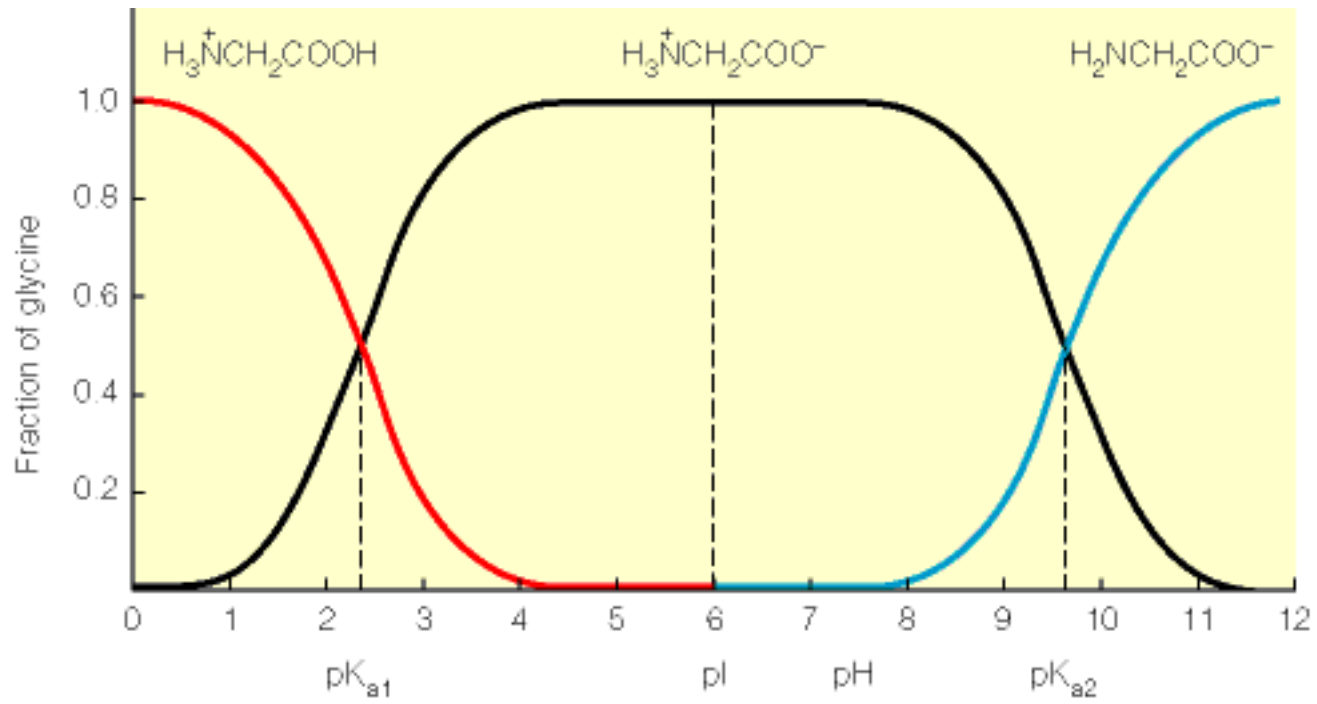

Figure 2.19: The relative concentrations of the three forms of glycine as a function of pH.



pI

Ampholytes and polyampholytes contain groups whose electrostatic charge depends on the pH of the solution.

Each molecule has a distinct pH (called the **pI** or **isoelectric point**) at which the net average charge of all the groups adds up to zero. If acidic groups predominate, the pI will be low. If basic groups predominate, the **pI** will be high.

For ampholytes, like [glycine](#), which have only a single acidic group and a single basic group, the **pI** can be determined by averaging the pKas of the two groups (from Equation 2.18) For example, the pKa values of the carboxylate and amino groups on glycine are 2.3 and 9.6, respectively. Thus,

$$\mathbf{pI} = (2.3 + 9.6)/2 = 5.95 \text{ (See [Figure 2.19](#))}$$

Molecules with larger numbers of acidic and basic groups typically do not have **pIs** that can be as straightforwardly determined. This is because the pKa of a group on a molecule with many ionizing groups is influenced by the state of ionization of the others and will not behave identically to the same group alone on another molecule.

See also: [Ampholytes](#)

Zwitterion



A **zwitterion** is a molecule with equal numbers of positive and negative charges - thus the net charge is zero. Amino acids, such as glycine, are often **zwitterions** at physiological pH.

See also: [Glycine](#), [Figure 5.2b](#)

Figure 5.2: The structure of α -amino acids.

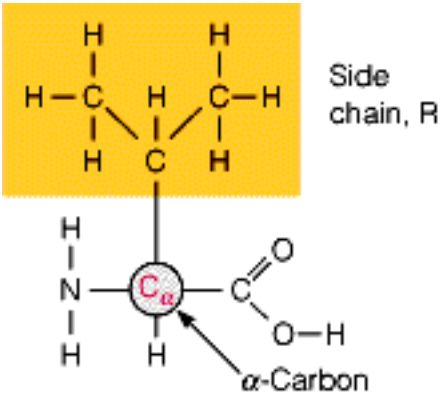

(a) Valine

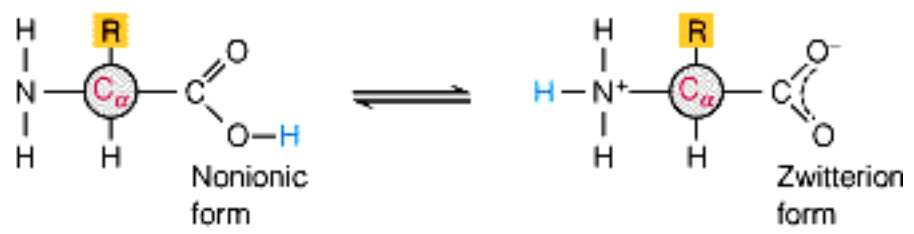

(b) Generalized amino acid, forming zwitterion at neutral pH

Polyampholytes

Large molecules, such as [proteins](#), can contain many acidic and basic groups. Such molecules are called **polyampholytes**. With more than two charged groups present, the calculation of pI becomes more complicated. However, as long as the molecule has both positively and negatively charged groups, it always has an isoelectric point, at which the net average charge is zero.

If acidic groups predominate, the pI will be low. If basic groups predominate, the pI will be high.

See also: [Ampholytes](#), [pI](#), [Isoelectric Point](#)

Unnumbered Item

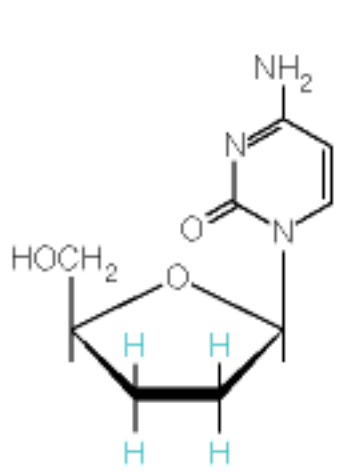

2',3'-Dideoxycytidine

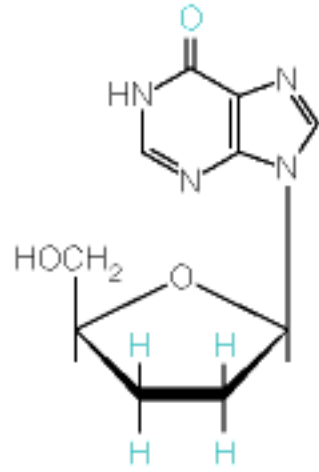

2',3'-Dideoxyinosine

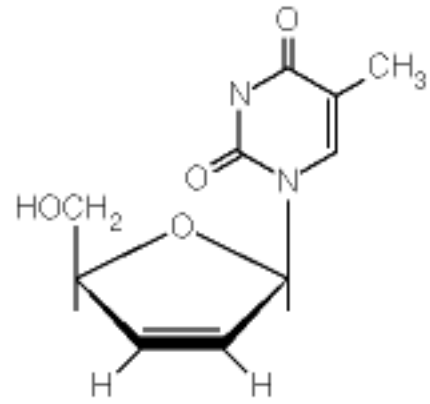

2',3'-Didehydro-3'-deoxythymidine

2',3'-Dideoxycytidine (ddC)

ddC is a drug used for the treatment of HIV infections. This **nucleoside** is anabolized to the corresponding 5' triphosphate, which acts as an inhibitor of viral **reverse transcriptase** in making **DNA** from the viral **RNA**.

Other inhibitors of reverse transcriptase are shown [here](#).

See also: [Salvage Routes to Deoxyribonucleotide Synthesis](#), [Nucleotide Analogs in Medicine](#), [Thymidine Kinase](#)

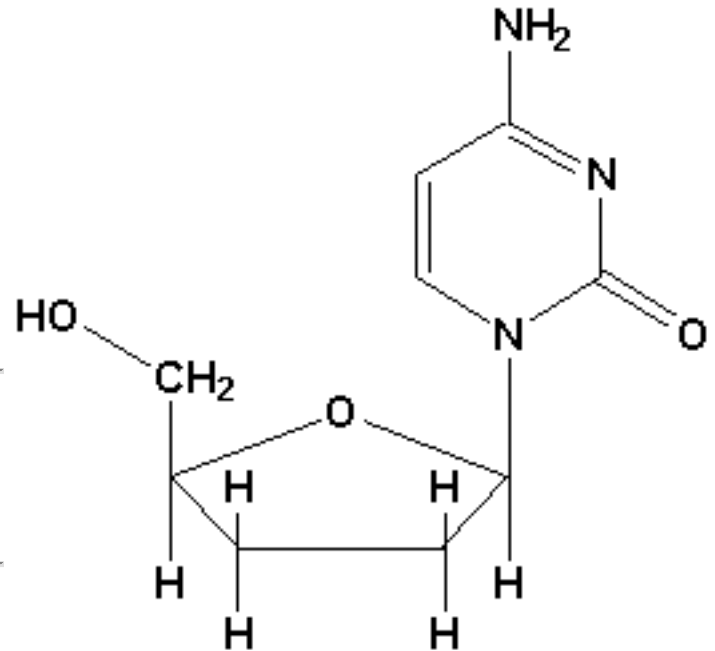

2',3'-Dideoxycytidine (ddC)

2',3'-Dideoxyinosine (ddI)

ddI is a drug used for the treatment of HIV infections. This **nucleoside** is anabolized to the corresponding 5' triphosphate, which acts as an inhibitor of viral **reverse transcriptase** in making **DNA** from the viral **RNA**.

Other inhibitors of reverse transcriptase are shown [here](#).

See also: [Salvage Routes to Deoxyribonucleotide Synthesis](#), [Nucleotide Analogs in Medicine](#), [Thymidine Kinase](#)

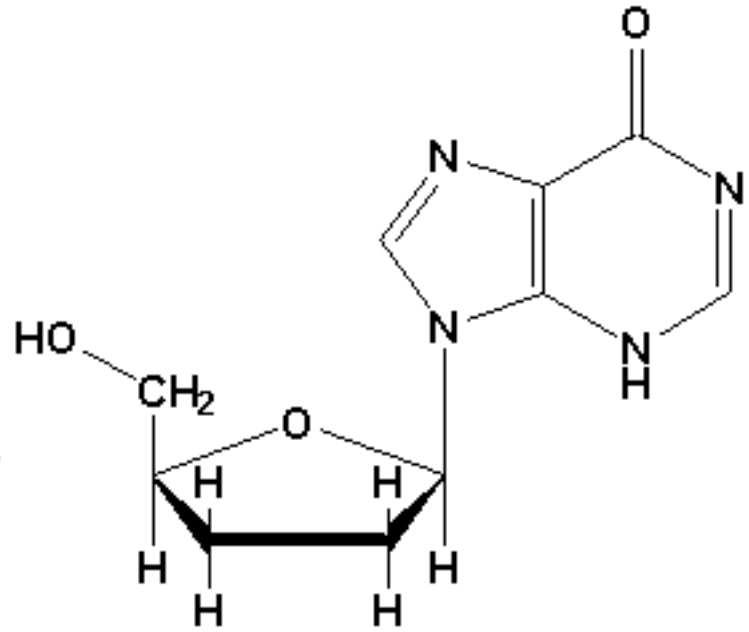

2',3'-Dideoxyinosine (ddI)

Retrovirus Replication

Retroviruses are small RNA viruses containing a single strand of RNA in their genome. HIV, the virus that causes AIDS, is a retrovirus. A simple view of the **retrovirus** life cycle is shown in [Figure 24.45](#). An essential part of the **retrovirus** life cycle is converting the RNA genomic material back to DNA. This involves an RNA-dependent DNA polymerase called **reverse transcriptase** that uses an RNA as a template to make DNA. Like other RNA-dependent polymerases, reverse transcriptase is very error prone because it contains no proofreading activity. The replication scheme is as follows:

1. Viral RNA in the host cell base pairs with a specific tRNA molecule to provide a primer for DNA replication.
2. Reverse transcriptase makes DNA towards the 5' end of the viral RNA.
3. RNase H partially degrades RNA from the RNA-DNA duplex, removing the 5' terminus.
4. The 3' terminus of the viral RNA base pairs with the overhanging DNA strand, forming a circle-like structure.
5. Reverse transcriptase makes a DNA copy of the entire genome, using the 3' end of the DNA strand as a primer.
6. The RNA strand of the duplex is removed and a DNA strand complementary to the first DNA strand is synthesized to form a duplex.
7. The duplex integrates into the host chromosome.

Once inside the genome, the integrated viral DNA can persist in a noninfectious state for many years, with most of its own genes turned off. Environmental stresses, still undetermined, can trigger excision of the integrated viral genome and return the virus to an infectious state.

One of the great difficulties in devising treatments against HIV is the absence of a proofreading exonuclease in HIV reverse transcriptase. This leads to frequent replication errors and high rates of spontaneous mutagenesis, allowing the virus to generate variants that have resistance to the treatment.

See also: [RNA Viruses](#)

INTERNET LINKS:

1. [All the Virology on the WWW](#)
 2. [HIV Insite](#)
 3. [General Replication Strategies for RNA Viruses](#)
 4. [A Multimedia AIDS and HIV Resource](#)
-

Figure 24.45: Simplified view of retrovirus life cycle.

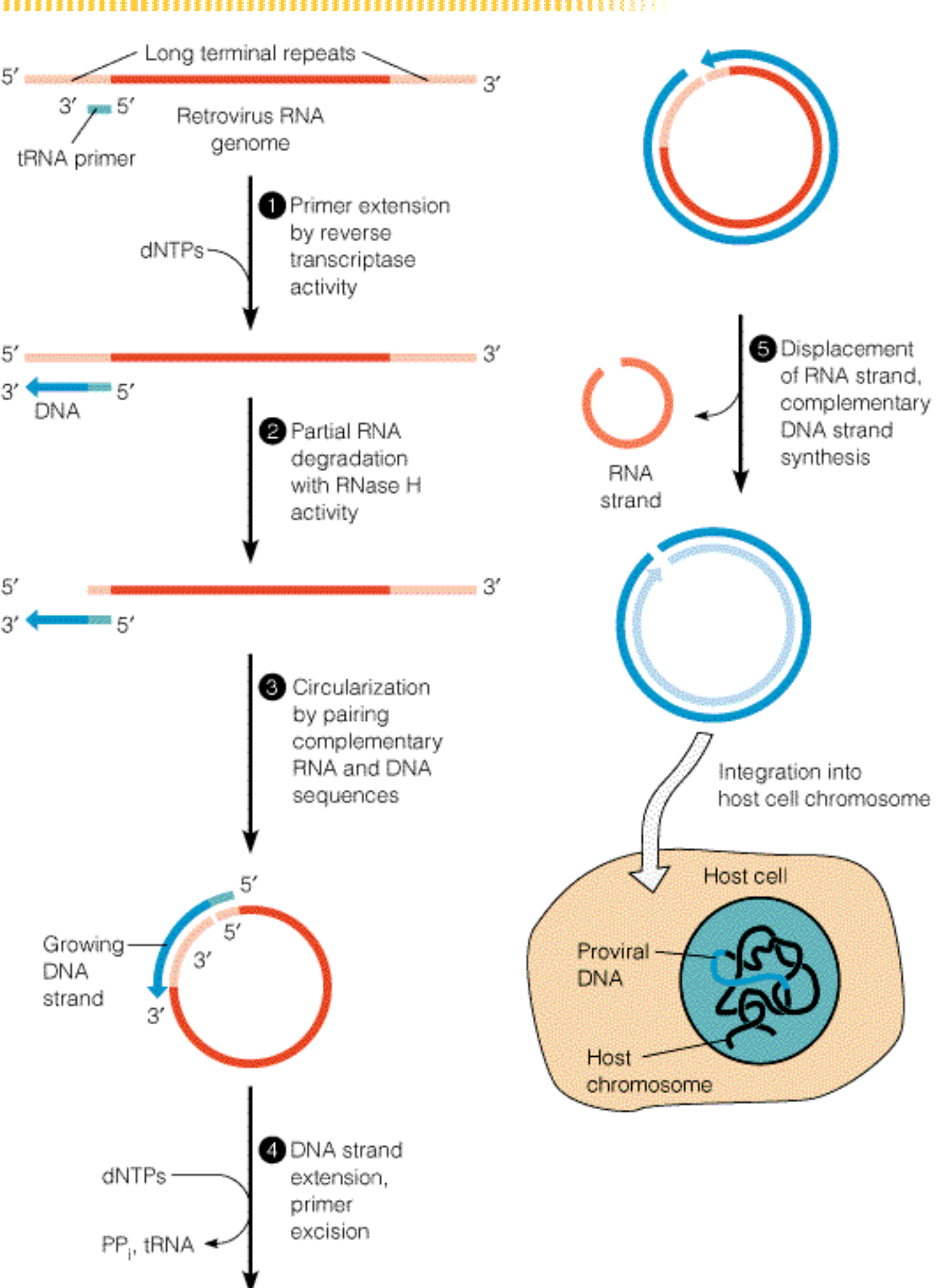



RNA Viruses

Virtually all known plant viruses contain RNA as the genetic material, instead of DNA. So, too, do several bacteriophages, some animal viruses (such as polio virus and influenza viruses), and the retroviruses, which are responsible for many tumors and for acquired immune deficiency syndrome (AIDS).

There are many schemes by which RNA viruses replicate their genetic material. In each case, however, RNA viruses must be able to convert RNA to DNA (like the retroviruses) or they must be able to replicate RNA using an RNA-dependent RNA polymerase.

RNA genomes can consist of single stranded RNAs, double stranded-RNAs, or even segmented RNAs (several separate RNA molecules). RNA-copying enzymes all lack proofreading abilities, so they are much more prone to errors than DNA polymerases. This enables these viruses to mutate and evolve far more rapidly than the organisms they infect, enabling such a virus to change so rapidly that it evades or counteracts the host's defense mechanisms.

See also: [Retrovirus Replication](#)

INTERNET LINKS:

1. [All the Virology on the WWW](#)
 2. [HIV Insite](#)
 3. [General Replication Strategies for RNA Viruses](#)
-

Tetrahydrofolate Coenzymes

Tetrahydrofolate coenzymes are derived from the vitamin folic acid (see structure [here](#)) and they participate in the generation and utilization of single-carbon functional groups-methyl, methylene, and formyl. Once inside of a cell, folate is converted to active forms ([dihydrofolate](#) and **tetrahydrofolate**) by two successive reductions catalyzed by the NADPH-specific enzyme, [dihydrofolate reductase](#) (DHFR) (see [here](#)). Activity of DHFR is blocked by folate analogs, such as aminopterin (see [here](#)) and amethopterin ([methotrexate](#)). The coenzymatic function of **tetrahydrofolate** is the mobilization and utilization of single-carbon functional groups. These reactions are involved in the metabolism of serine (see below), glycine (see below), and methionine (see [here](#)), among the amino acids. Single carbon units derived from **tetrahydrofolate coenzymes** are also used in the synthesis of purine nucleotides ([Figure 22.4](#) and [Figure 22.5](#)) and thymine nucleotides ([Figure 22.18](#)).

[Figure 20.17](#) shows the metabolic reactions involving single-carbon adducts of **tetrahydrofolate**.

Tetrahydrofolate can acquire single-carbon units from diverse sources. Degradation of histidine, in both bacterial and animal cells, yields 5-formiminotetrahydrofolate, as does the bacterial fermentation of purines. However, most organisms derive their activated single-carbon units from the β -carbon of serine and the subsequent oxidation of glycine, as follows:



The reaction can be reversed to provide a way to synthesize serine, as well. In mitochondria, the glycine cleavage system can catalyze the following reaction:



This reaction is the chief catabolic fate of glycine in most cells.

[5,10-Methenyltetrahydrofolate](#) acts as a chromophore in enzymes called photolyases that absorb light energy and use it to power the breaking of pyrimidine-pyrimidine bonds in damaged DNA.

See also: [Coenzymes in Nitrogen Metabolism](#), [De Novo Biosynthesis of Purine Nucleotides](#), [N-10-Formyltetrahydrofolate](#), [5-Methyltetrahydrofolate](#), [7,8-Dihydrofolate \(DHF\)](#)

INTERNET LINK: [One Carbon Pool by Folate](#)

Unnumbered Item

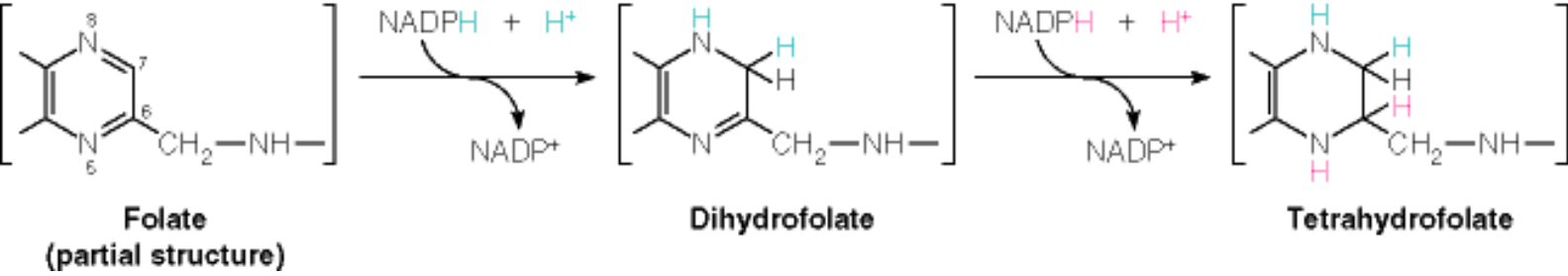

Unnumbered Item

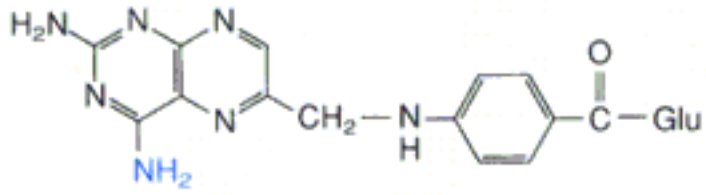

Aminopterin (4-aminofolate)

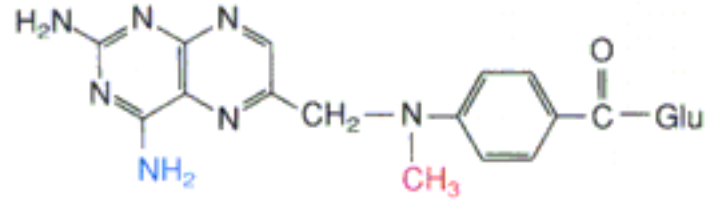

Amethopterin (4-amino-10-methylfolate)

Unnumbered Item

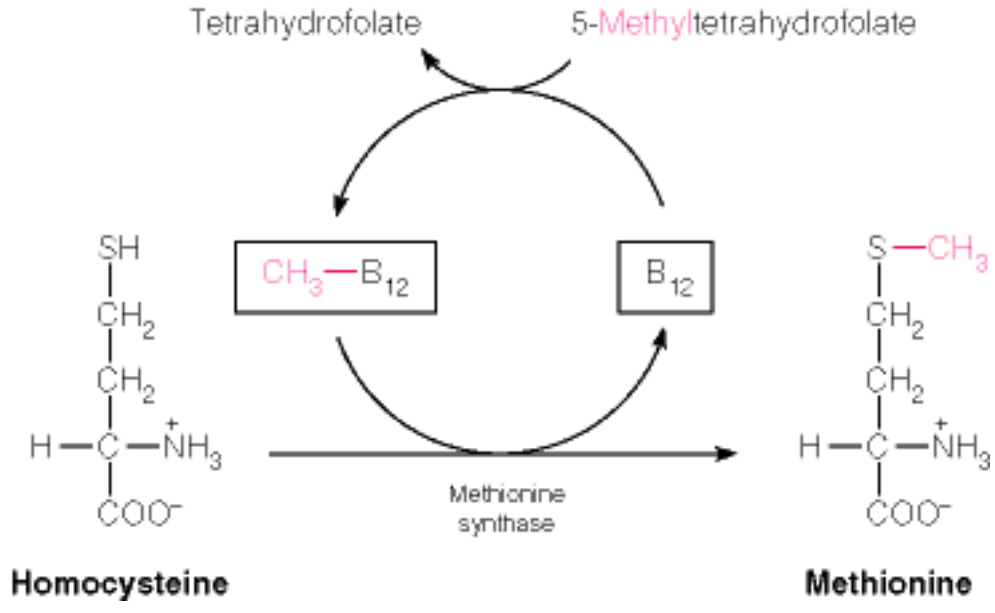

Figure 22.5: Transformylation reactions in purine nucleotide synthesis.

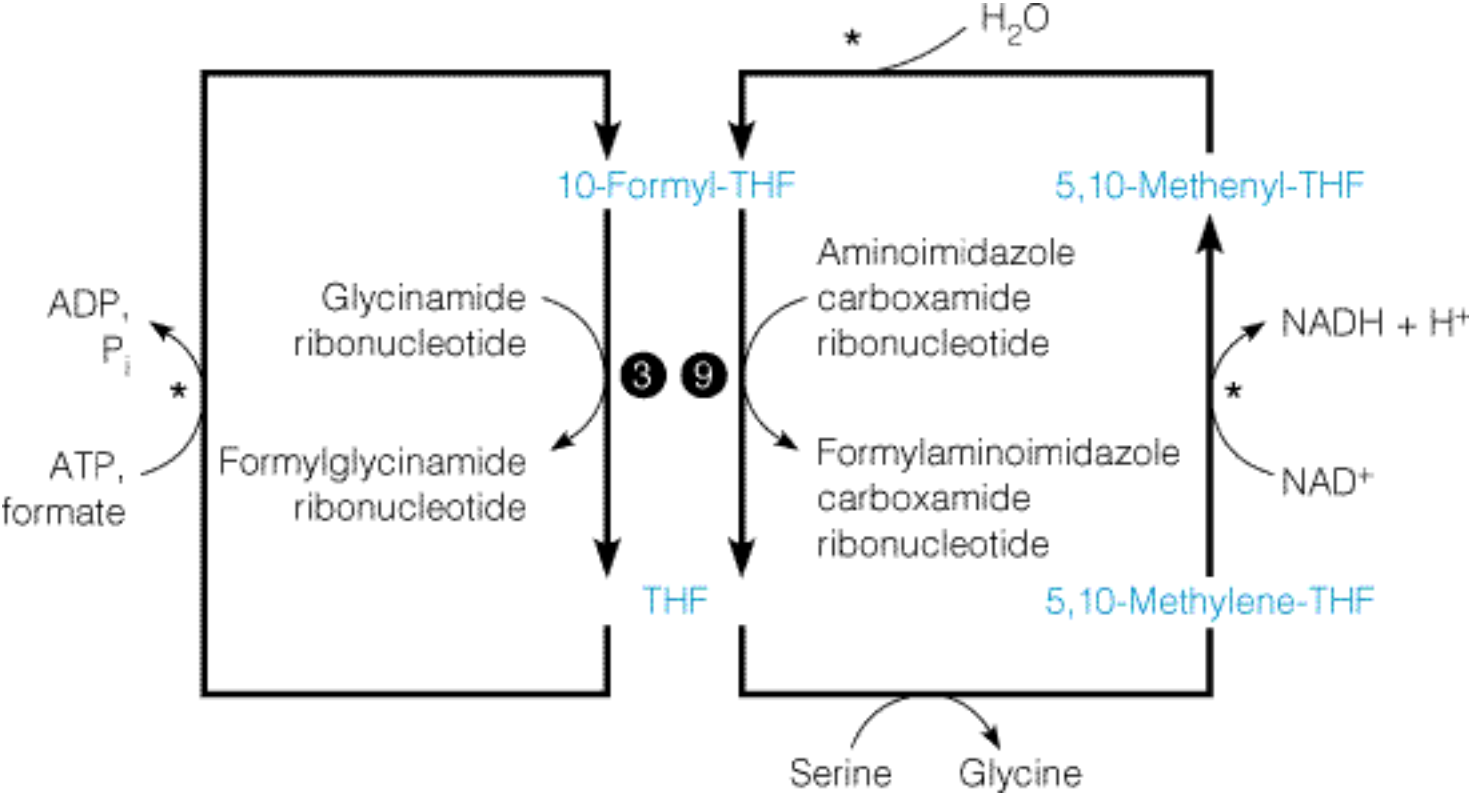
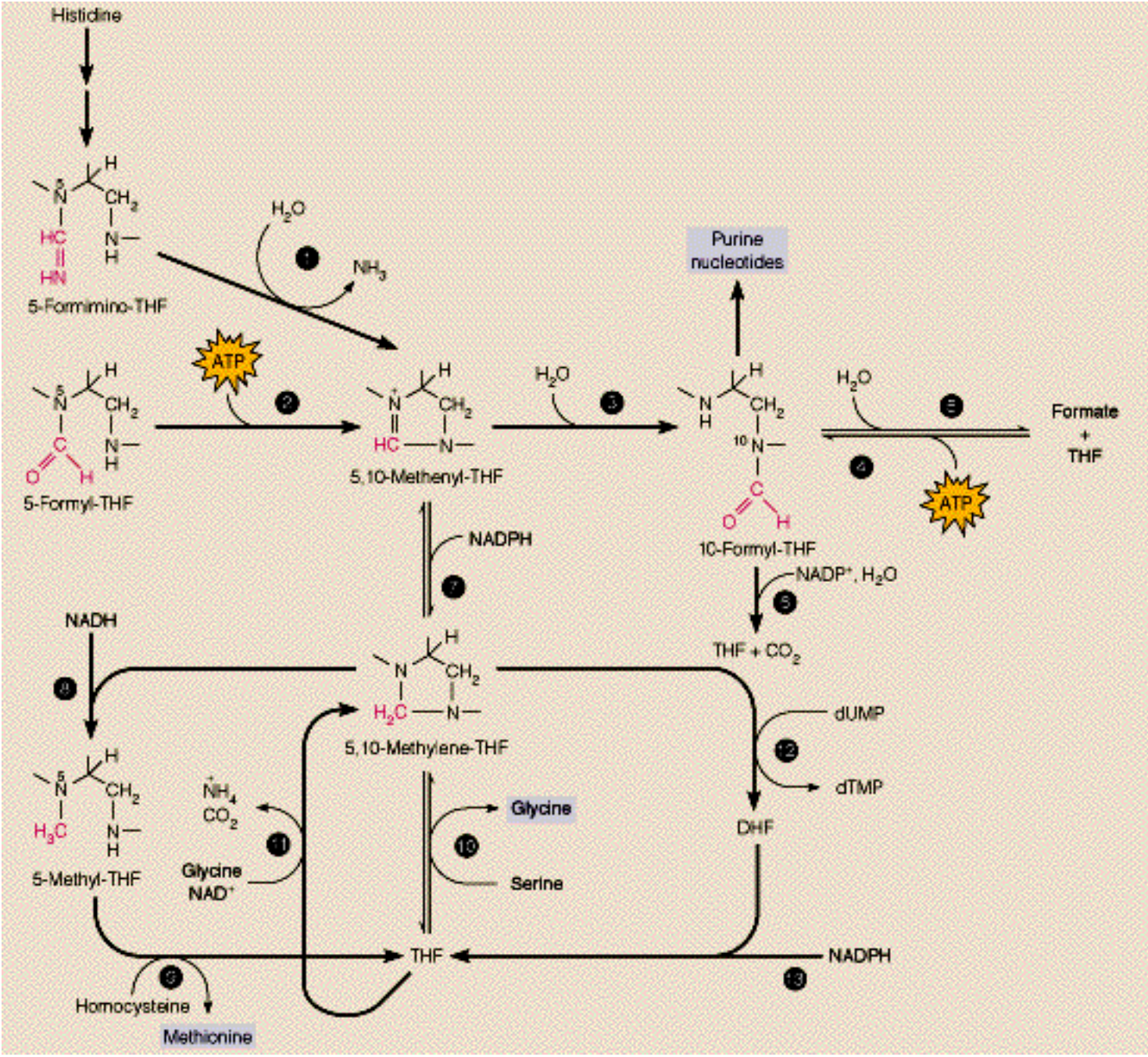

Figure 20.17: Metabolic reactions involving synthesis, interconversion, and utilization of single-carbon adducts of tetrahydrofolate.



5,10-Methenyltetrahydrofolate

5,10-Methenyltetrahydrofolate

is a tetrahydrofolate derivative involved in photoreactivation.

Photolyases are enzymes that use the energy of light to break covalent bonds between adjacent pyrimidines on a DNA strand. **5,10-**

Methenyltetrahydrofolate

functions like the photochemical reaction center, translating light energy to facilitate the transfer of an electron to the pyrimidine dimer and breaking the pyrimidine-pyrimidine bonds by a free radical mechanism, as shown in [Figure 25.10](#).

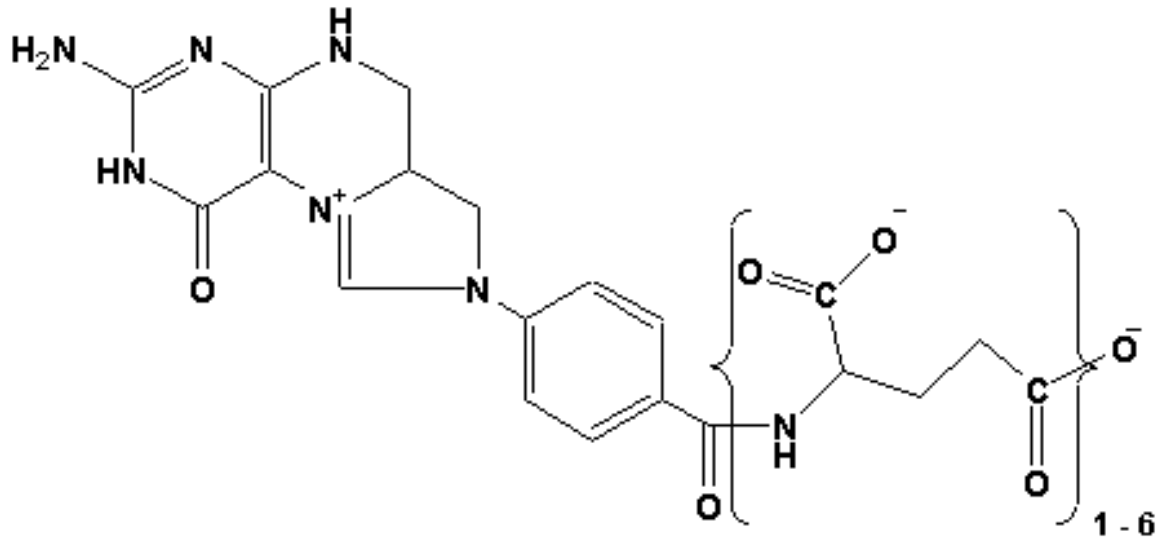

5,10-Methenyltetrahydrofolate

See also: [Photoreactivation](#), [Photochemistry](#), [Photosystem Summary](#), [Pyrimidine Dimers](#), [Thymine Dimers](#), [Tetrahydrofolate Coenzymes](#)

Figure 25.10: A mechanism for photolyase action.

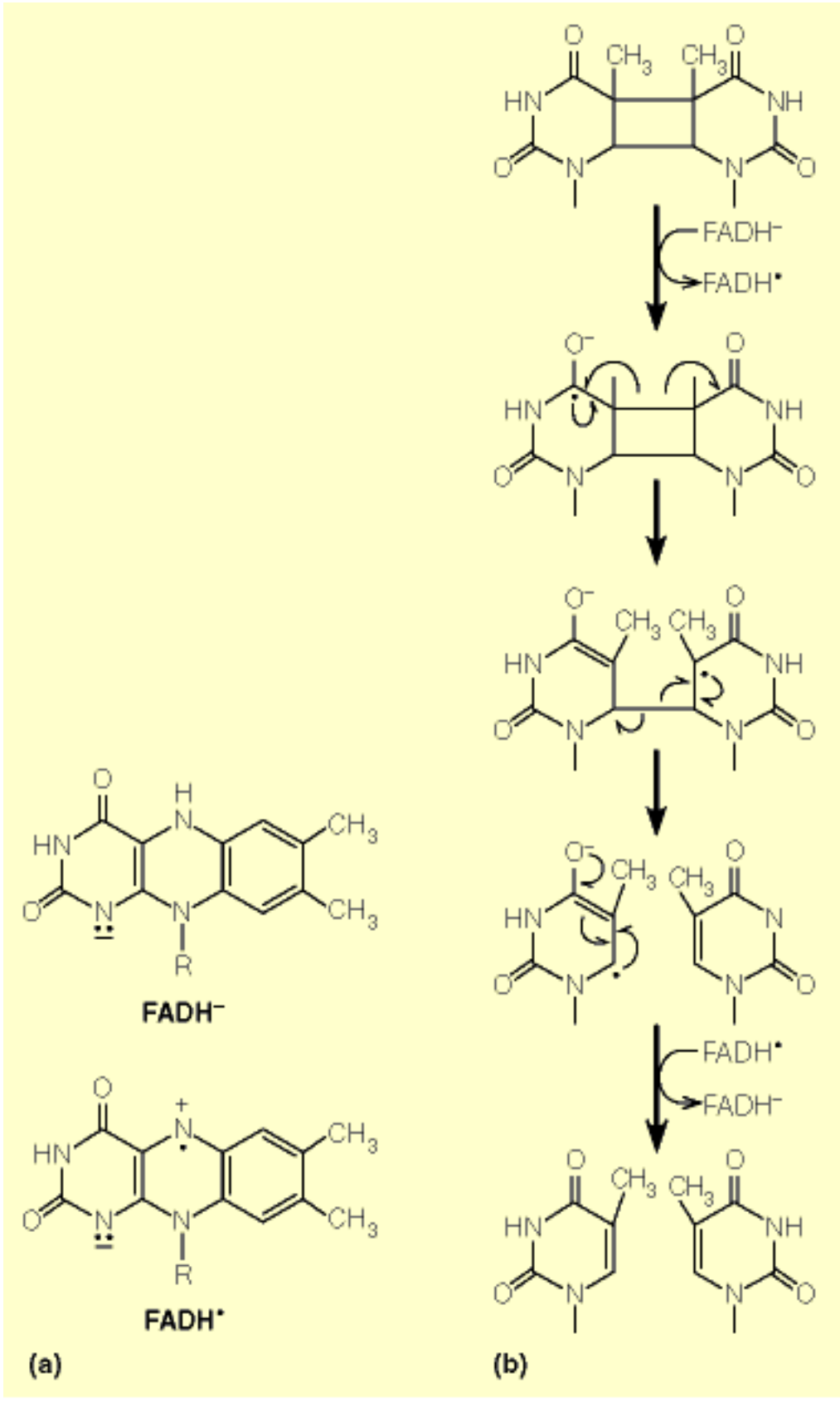

Photoreactivation

Most DNA repair processes remove the damaged nucleotides and several adjacent residues, then replace the excised region using information encoded in the complementary (undamaged) strand. Two processes, however, directly change the damaged bases, rather than removing them. They are **photoreactivation** and the process catalyzed by O⁶-alkylguanine alkyltransferase

The enzyme responsible for photoreactivation is called photoreactivating enzyme or DNA photolyase. It repairs cyclobutane pyrimidine dimers in the presence of visible light. A wavelength of 370 nm is most effective. Photoreactivating enzyme binds to DNA, in a light-independent process, at the site of pyrimidine dimers. In the presence of visible-wavelength light, the bonds linking the pyrimidine rings are broken, after which the enzyme can dissociate in the dark.

Photoreactivating enzyme contains two chromophores. (A chromophore is a structural moiety that absorbs light of characteristic wavelengths.) One chromophore is flavin adenine dinucleotide in the reduced state, FADH⁻. The second chromophore in some photolyases is [5,10-methenyltetrahydrofolate](#) and in others is [8-hydroxy-5-deazaflavin](#).

Mechanistic studies suggest a process akin to photosynthesis, with the second chromophore functioning as a light-harvesting factor, and FADH⁻ functioning like the photochemical reaction center, translating light energy to facilitate the transfer of an electron to the dimer and breaking the pyrimidine-pyrimidine bonds by a free radical mechanism, as shown in [Figure 25.10](#).

Photolyase has been detected in numerous eukaryotic systems, but recent evidence indicates that human cells do not contain an enzyme for photoreactivation.

See also: [Pyrimidine Dimers](#), [O⁶-Alkylguanine Alkyltransferase](#), [Types and Consequences of DNA Damage](#), [Light Absorbing Pigments](#) (from Chapter 17), [Photochemistry](#) (from Chapter 17), [Photosystem Summary](#) (from Chapter 17)

INTERNET LINKS:

1. [DNA Repair](#)
 2. [Optimum Color Range for UV Mutagenesis Repair](#) (online paper)
-

8-Hydroxy-5-Deazaflavin

8-Hydroxy-5-deazaflavin is a chromophore in some photolyases (photoreactivating enzymes). Photolyases are enzymes that use the energy of light to break covalent bonds between adjacent pyrimidines on a DNA strand. **8-Hydroxy-5-deazaflavin** functions like the photochemical reaction center, translating light energy to facilitate the transfer of an electron to the pyrimidine dimer and breaking the pyrimidine-pyrimidine bonds by a free radical mechanism, as shown in [Figure 25.10](#).

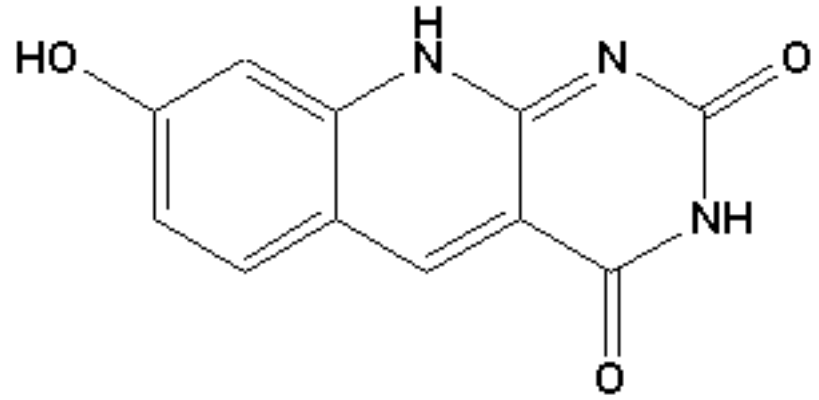

8-Hydroxy-5-deazaflavin

See also: [Photoreactivation](#), [Photochemistry](#), [Photosystem Summary](#), [Pyrimidine Dimers](#), [Thymine Dimers](#)

Photochemistry

In the presence of light, **chloroplasts** are capable of driving thermodynamically unfavorable reactions.

Two kinds of photosystems are involved in photosynthesis in plants. **Photosystem I** (PSI) absorbs light around 700 nm and **photosystem II** (PSII) absorbs light only to a wavelength of about 680 nm. In algae, cyanobacteria, and all higher plants, these two photosystems are linked in series to carry out the complete sequence of the light reactions.

Figure 17.12 illustrates the two photosystems and the paths taken by electrons through them.

In each of the two photosystems, the primary step is transfer of a light-excited electron from a reaction center (P680 or P700) into an electron transport chain.

The ultimate source of the electrons is water molecules. In this part of the process, the destination of the electrons is NADP^+ , to form NADPH.

At two stages in the process of transporting electrons, protons are released into the **thylakoid lumen**. The transfer of protons into the lumen produces a pH gradient across the thylakoid membrane. The resulting proton gradient is used to drive the synthesis of ATP in a manner very similar to that used in **oxidative phosphorylation**. In oxidative phosphorylation, mitochondria establish a proton gradient that allows the synthesis of ATP to be coupled to electron transport.

Thus, ATP and the reducing power of NADPH are the products of the light reactions.

See also: **Integrity of Mitochondrial Membranes**, (from Chapter 15), **Electron Transport** (from Chapter 15), **Chlorophyll**

Photosystem Summary

1. Light energy causes electrons to be taken from water and end up in [NADPH](#).
2. The summary of all reactions for photosystems I and II is given [here](#). In addition, protons have been pumped from the stroma into the thylakoid lumen during the passage of each electron through the electron transport chain. The pH gradient arising from proton pumping can be quite large - as much as 3.5 pH units in brightly illuminated chloroplasts. The protons reenter the stroma only through ATP synthase complexes ([Figure 17.15](#)), as in [oxidative phosphorylation](#).
3. ATP is generated in the thylakoid membranes of chloroplasts by a complex called [CF₀-CF₁](#) and is very similar to the F₀F₁ complex of mitochondria. As in mitochondria, passage of protons through the ATP synthase complex (CF₀-CF₁), is the driving force (and energy source) for ATP synthesis.
4. Photosystems I and II, the cytochrome b₆f complex, and ATP synthase (CF₀-CF₁) are all individual entities in the thylakoid membrane, but are not necessarily contiguous. Components that link the photosystems (plastoquinone in the lipid phase of the membrane and [plastocyanin](#) in the thylakoid lumen) are mobile. [Figure 17.16](#) shows the arrangement of components of the two photosystems on the thylakoid membrane. Note that the interior membrane layers of the grana are rich in PSII, whereas the stroma lamellae are rich in PSI.

See also: [The F₀F₁ Complex](#) (from Chapter 15), [Photosystem II](#), [Photosystem I](#), [Cyclic Electron Flow](#), [Thylakoid Lumen](#), [Cytochrome b₆f](#), [Plastoquinones](#),

INTERNET LINK: [Photosynthesis Metabolic Scheme](#)

Unnumbered Item

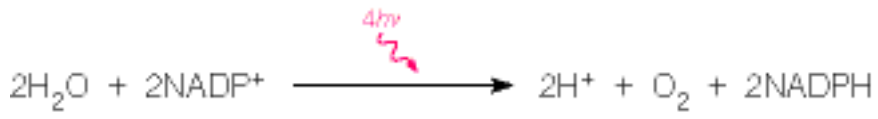

Plastocyanin

Plastocyanin is an electron carrier in the system that operates between photosystem II and I ([Figure 17.12](#)). **Plastocyanin** accepts electrons from cytochrome f of the cytochrome b6f complex and donates them to photosystem I. **Plastocyanin** contains a copper atom, which is reduced to Cu^+ upon accepting an electron and Cu^{2+} upon losing the electron.

See also: [Photosystem II](#), [Photosystem I](#), [Cyclic Electron Flow](#), [Cytochrome b6f](#)

Cyclic Electron Flow

The process depicted in [Figure 17.12](#) of transferring electrons from [photosystem II](#) (PSII) to [photosystem I](#) (PSI) and from water to PSII is called noncyclic electron flow. The generation of ATP by this process is called noncyclic photophosphorylation. An alternative pathway for the light reactions, called **cyclic electron flow**, utilizes the components of photosystem I, [plastocyanin](#), and the [cytochrome b6f](#) complex. ([Figure 17.17](#))

Cyclic electron flow of electrons occurs when NADP^+ is present in only small amounts in the chloroplast [stroma](#). Under these conditions, electrons from [ferredoxin](#) (Fd) are transferred to the b6f complex, which returns them to the P700 center. When this happens, no oxygen is released and no NADP^+ is reduced. About one ATP is produced for every two electrons that complete the cycle in a process called **cyclic photophosphorylation**.

Cyclic photophosphorylation thus can produce ATP when little NADP^+ is available to accept electrons (i.e., NADPH levels are high). This may be important when the dark reactions require more ATP than can be produced by noncyclic flow.

See also: [Calvin Cycle](#), [Photosystem Summary](#), [Chlorophyll](#)

Cytochrome b

Cytochrome b6f is a part of the electron transport chain that transfers electrons from photosystem II to photosystem I. **Cytochrome b6f** is a complex of proteins that includes **cytochromes f, b6**, and an iron sulfur protein. **Cytochrome b6f** accepts electrons from [plastoquinone QH2](#) and passes them to [plastocyanin](#) ([Figure 17.12](#)). In addition to transferring electrons, the **cytochrome b6f** complex pumps protons into the thylakoid lumen, helping to build the proton gradient, which is used by the [CF0-CF1 complex](#) to make ATP.

See also: [Photosystem II](#), [Photosystem I](#), [Photosystem Summary](#), [Cyclic Electron Flow](#), [Figure 17.16](#)

INTERNET LINK: [Cytochrome b6f Complex](#)

Figure 17.17: Cyclic electron flow.

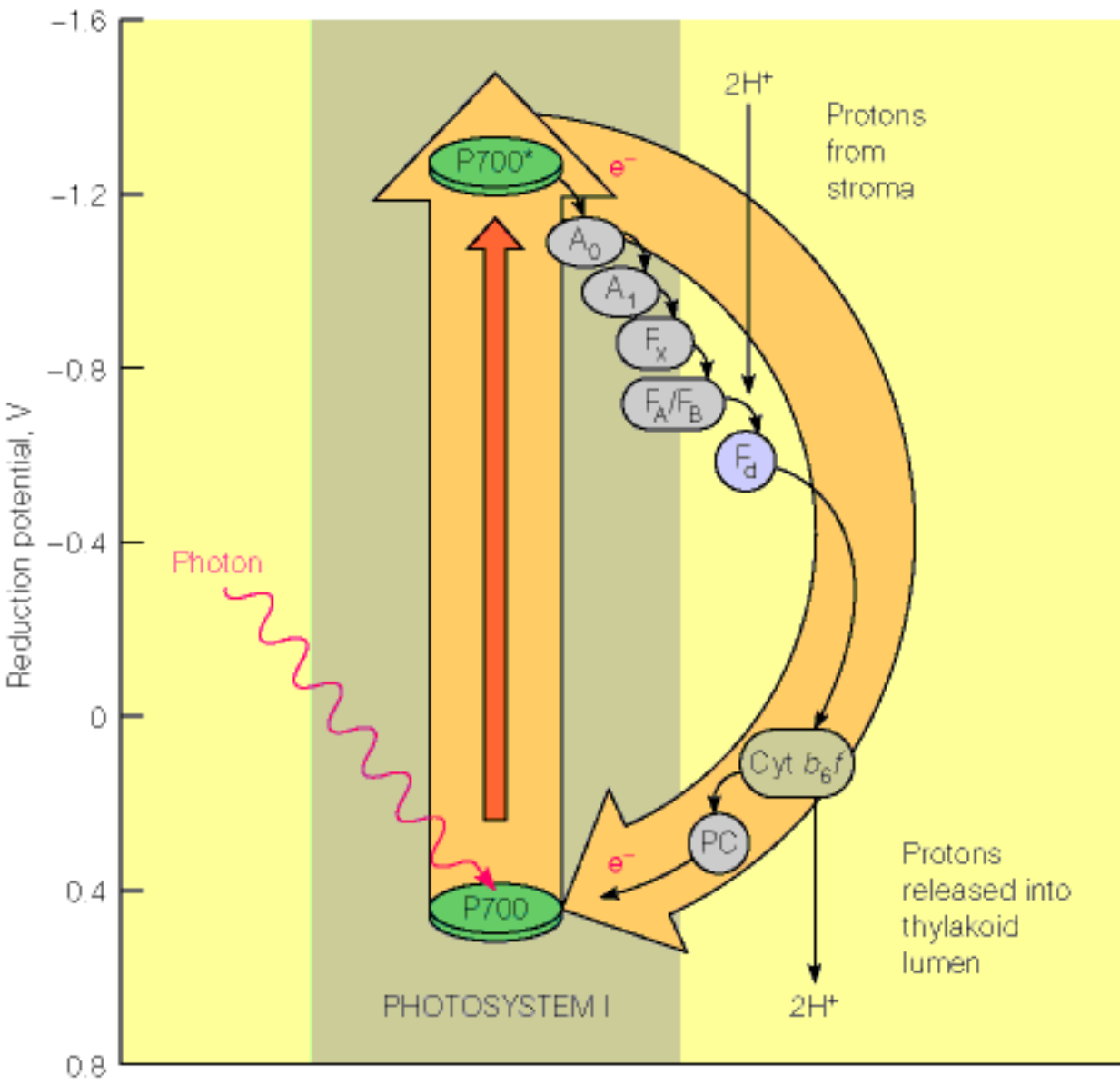

Pyrimidine Dimers

Wavelengths of ultraviolet (UV) light that are most effective in stimulating mutagenesis or death lie near 260 nm, where DNA light absorption is maximal. UV-irradiated DNA contains small amounts of many different altered DNA constituents, called **photoproducts**. Prominent among them are **intrastrand dimers** consisting of two **pyrimidine** bases joined by a cyclobutane ring structure formed from carbons 5 and 6 on each **pyrimidine** ring ([Figure 25.9a](#)). Dimerization draws the adjacent **thymine** residues together, distorting the helix in such a way that replicative polymerization past this site is blocked. The ability of an organism to survive ultraviolet irradiation is related directly to its ability to remove thymine dimers from its DNA. **Cyclobutane thymine dimers** are removed from UV-irradiated DNA by photoreactivation.

The photoproduct that is the principle form of UV-induced mutation is shown in [Figure 25.9b](#). This structure is also a dimer, linked via C-6 of the 5' pyrimidine (either thymine or **cytosine**) and C-4 of the 3' pyrimidine (usually cytosine).

See also: [Photoreactivation](#), [Types and Consequences of DNA Damage](#), [Thymine Dimers](#)

Figure 25.9: Structures of pyrimidine dimer photoproducts.

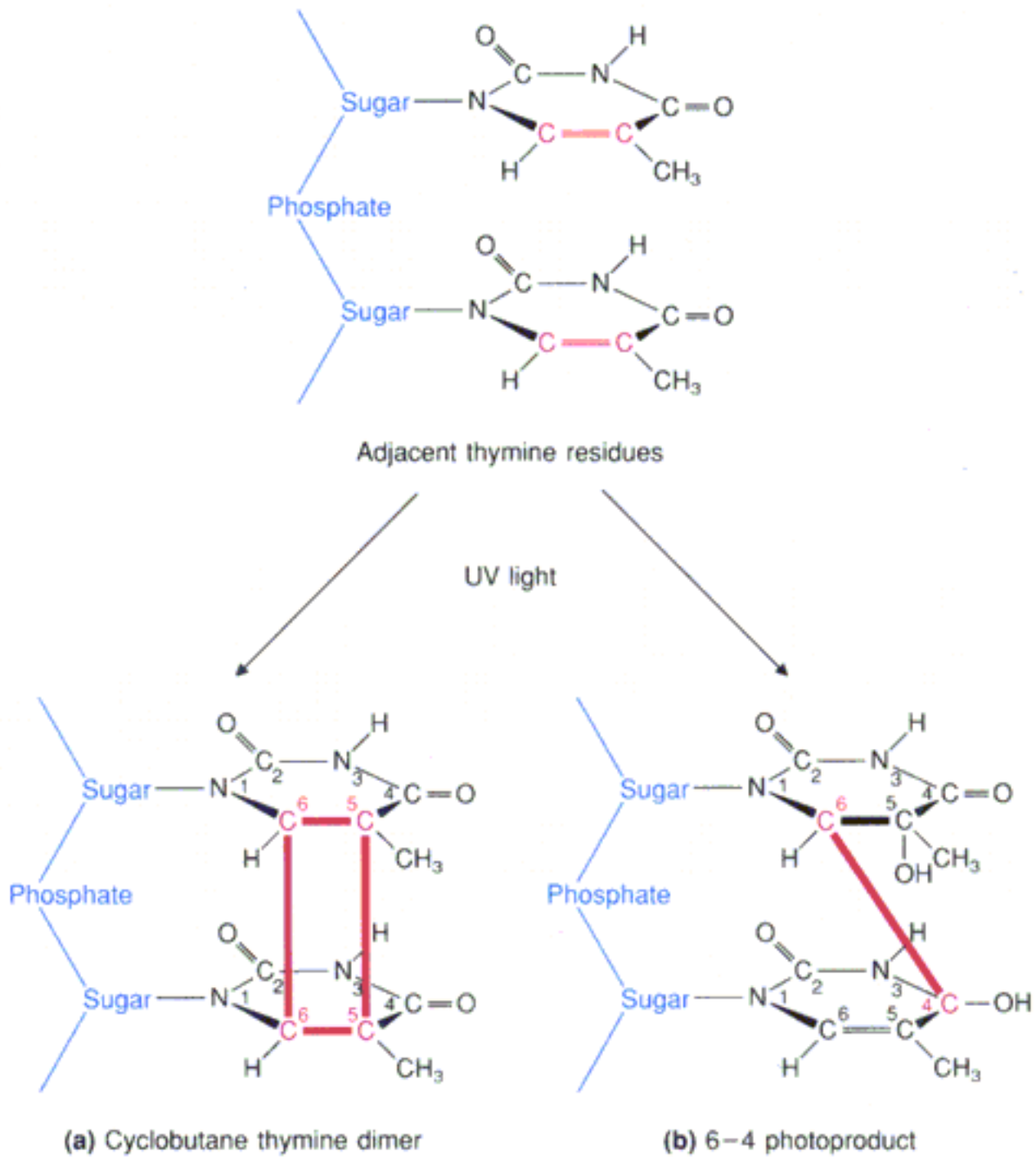

Types and Consequences of DNA Damage

The consequences of irradiation or alkylation **damage** include mutagenesis, resulting from erroneous replication of a damaged template base, and cell death, resulting from the inability of the replication apparatus to copy past a damaged site. DNA has a special need for metabolic stability. Its information content must be transmitted virtually intact from one cell to another during cell division or reproduction of an organism. The chemical stability of DNA is maintained in the following two ways:

1. By a replication process of very high accuracy that prevents most errors from occurring in the first place.
2. By mechanisms for correcting genetic information when DNA suffers damage.

Error reduction systems include proofreading (see [here](#)) and the uracil-DNA N-glycosylase system (see [here](#)), which protects against mutation arising from deamination of cytosine. Other processes for repairing DNA that is altered either by uncorrected replicative errors or by **environmental damage** are listed below. Cellular repair systems include the following:

1. Direct repair, in which a damaged DNA base is chemically altered to restore the original structure.
2. **Nucleotide excision repair**, in which a section of DNA that contains a damaged site is excised and replaced with normal DNA.
3. **Base excision repair**, which starts with cleavage of the glycosidic bond connecting a damaged base to the DNA sugar-phosphate backbone.
4. **Recombinational repair**, in which newly replicated DNA duplexes undergo genetic recombination, with ultimate removal of the damaged DNA segment.
5. Mismatch repair (**prokaryotic** or **eukaryotic**), a process that recognizes DNA mismatches created either by replication errors, non-homologous recombination, or damage to one DNA base, and corrects the error.

See also: [Pyrimidine Dimers](#), [Thymine Dimers](#) [Photoreactivation](#), , [Postreplication Repair](#), , [RecA / SOS Response](#), [Antioxidants](#) (from Chapter 15), [Oxygen Metabolism and Human Disease](#) (from Chapter 15).

Fidelity of DNA Replication

DNA replication is, by far, the most accurate of known enzyme-catalyzed processes. The error rate per base pair per round of replication is about 10^{-9} to 10^{-10} . The accuracy cannot be explained, however, by the different binding energies between correct and incorrect base pairs (this amounts to only a 100 to 1000 fold difference between correct and incorrect pairing).

Two cellular systems aid the fidelity of replication. These include the following:

1. The 3'-5' exonuclease activity of DNA polymerases acts as a "proofreading" system. This appears to function based on the slow rate at which incorrectly paired nucleotides are extended by the DNA polymerase. Correctly incorporated nucleotides have subsequent nucleotides put onto them very fast (**Figure 24.36**). Incorrectly incorporated nucleotides are not readily extended by the polymerase very efficiently, allowing them to be melted away to the 3'-5' exonuclease site of the polymerase for removal (**Figure 24.44**).
2. The mismatch repair system makes an additional contribution to accuracy of about 100-fold. It works by scanning the newly replicated DNA, excising any residues that are not properly base-paired and replacing them with the correct nucleotides.

The role of hydrogen bonding between bases as a fidelity-improving mechanism during polymerization has been brought into question with the fact that a geometric derivative of dTTP is readily incorporated by Klenow fragment of **DNA Polymerase I** very readily, despite being unable to form hydrogen bonds with **dAMP** in the template DNA.

See also: [E. coli DNA Polymerases](#), [Other Replication Proteins](#)

INTERNET LINK: [Mismatch Repair](#)

Figure 24.44: Kinetic basis for preferential excision of mismatched nucleotides by a 3' exonuclease site distant from the polymerase site.

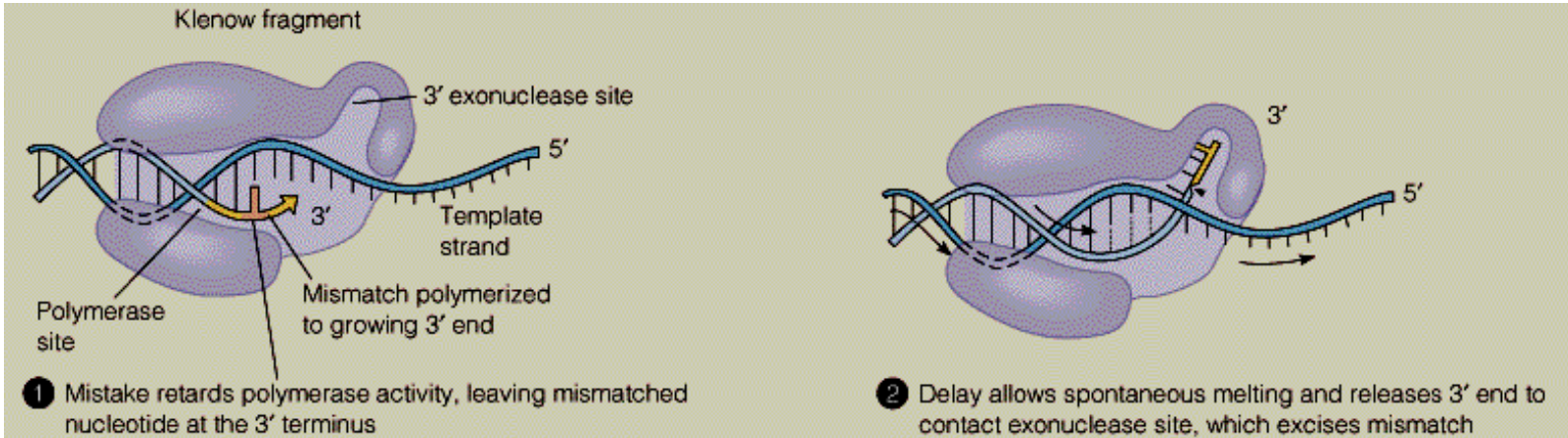

Deoxyadenosine Monophosphate (dAMP)

dAMP is a deoxyribonucleotide product of nuclease digestion of [DNA](#).

See also:

[Nucleotides](#),
[Pathways in Nucleotide Metabolism](#)

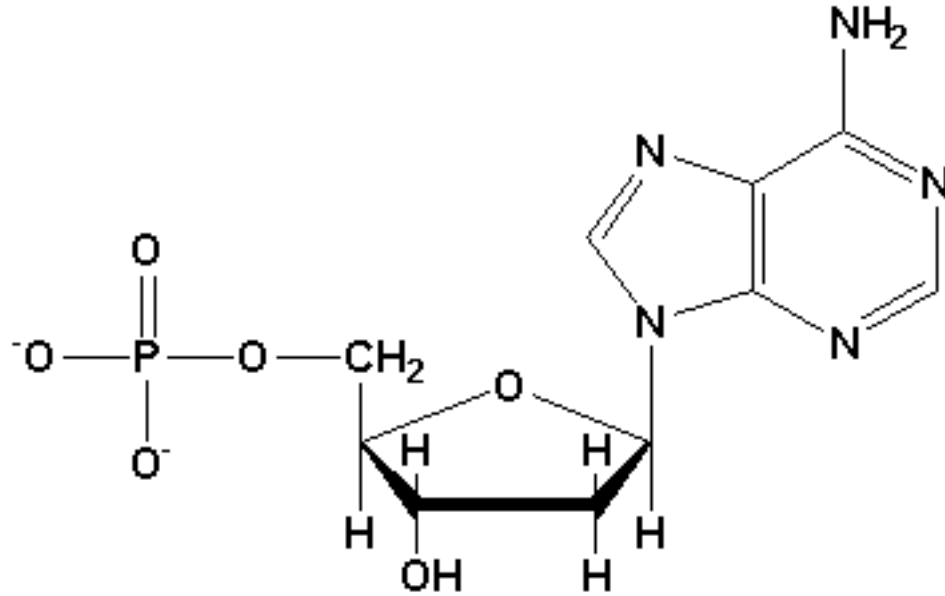

Deoxyadenosine Monophosphate (deoxyadenylate)

Pathways in Nucleotide Metabolism

Most organisms can synthesize purine and pyrimidine nucleotides ([Figure 4.2](#)) from low-molecular-weight precursors in amounts sufficient for their needs. These *de novo* pathways ([Figure 22.1](#)) are essentially identical in all organisms. [Nucleotides](#) can also be synthesized from the partial breakdown of previously synthesized nucleotides. These pathways are called salvage pathways. A schematic showing the simple relationships between *de novo* and salvage pathways is shown in [Figure 22.2](#).

Degradation of pyrimidine and purine bases can occur intracellularly as a result of cell death or, in animals, through digestion of nucleic acids ingested in the diet (major source). Cleavage begins at the phosphodiester bonds ([Figure 4.1](#)) with endonucleases (pancreatic ribonuclease or DNase) in the small intestine. The oligonucleotides resulting from this action are then cleaved exonucleolytically by nonspecific enzymes called phosphodiesterases. The products of this reaction are 5' or 3' monophosphates, depending on the specificities of the enzymes. Phosphomonoesterases called nucleotidases cleave phosphates from the nucleotides, yielding nucleosides and orthophosphate. Nucleoside phosphorylases act, as shown [here](#) to yield a base and [ribose-1-phosphate](#). If bases or nucleosides are not reused for nucleic acid synthesis via salvage pathways, the bases are further degraded to [uric acid](#) (purines) or [\$\beta\$ -ureidopropionate](#) (pyrimidines).

Note that the reaction (shown [here](#)) is reversible, providing a way for a cell to rebuild a nucleoside from ribose-1-phosphate and a base. Some cells have enzymes called [nucleoside kinases](#) which, in the presence of ATP, convert the nucleoside to a nucleotide.

See also: [The Importance of PRPP](#), [De Novo Biosynthesis of Purine Nucleotides](#), [Excessive Uric Acid in Purine Degradation](#), [De Novo Pyrimidine Nucleotide Metabolism](#), [Nucleotide Salvage Synthesis](#), [Deoxyribonucleotide Biosynthesis](#), [Biosynthesis of Thymine Deoxyribonucleotides](#), [Salvage Routes to Deoxyribonucleotide Synthesis](#)

INTERNET LINKS:

1. [Purine Metabolism](#)
 2. [Pyrimidine Metabolism](#)
 3. [Purine and Pyrimidine Metabolism](#)
-

Nucleoside Kinases



Nucleoside kinases are a class of enzymes that catalyze the phosphorylation of nucleosides to make nucleoside monophosphates ([Figure 22.2](#)) as part of nucleotide biosynthetic salvage pathways. [ATP](#) provides the energy and phosphate for the reaction. Example enzymes include [thymidine kinase](#), [deoxycytidine kinase](#), and [deoxyguanosine kinase](#).

See also: [Salvage Routes to Deoxyribonucleotide Synthesis](#)

Deoxyguanosine Kinase



Deoxyguanosine kinase is a mitochondrial enzyme catalyzing phosphorylation of deoxyguanosine in purine nucleotide salvage biosynthesis.

See also: [Salvage Routes to Deoxyribonucleotide Synthesis](#)

Uracil-DNA N-Glycosylase

dUTP is an intermediate in the synthesis of **dTTP**. dUTP can also be readily incorporated into DNA by DNA polymerases in place of dTTP, because **uracil** can base-pair with **adenine**. When this occurs, there is no loss of or change in information. Another source of uracil in DNA is the spontaneous deamination of cytosine residues, which results in formation of a G-U base pair. When this occurs, there is a change in information, because subsequent replications of the U-containing strand would give rise to an A-T base pair, instead. As a result, cells employ two systems to prevent accumulation of deoxyuridylate residues in DNA.

First, cells contain an enzyme, **dUTPase**, which cleaves dUTP to **dUMP** + PPi.

Second, the enzyme **uracil-DNA N-glycosylase** removes any dUMP residues that make it into DNA. **Figure 24.35** shows how this repair system works. As seen in the figure, the uracil base is clipped from the sugar, followed by an adjacent nick in the DNA strand which contained the uracil. Nick translation by **DNA polymerase I** removes the apyrimidinic moiety and replaces it with **dTMP**. Finally, DNA ligase (see [here](#)) reseals the nick.

See also: [Biosynthesis of Thymine Deoxyribonucleotides](#) (from Chapter 22), [Deoxyuridine Nucleotide Metabolism](#) (from Chapter 22), [Replication Complexes](#)

Figure 24.35: Action of the DNA uracil repair system.

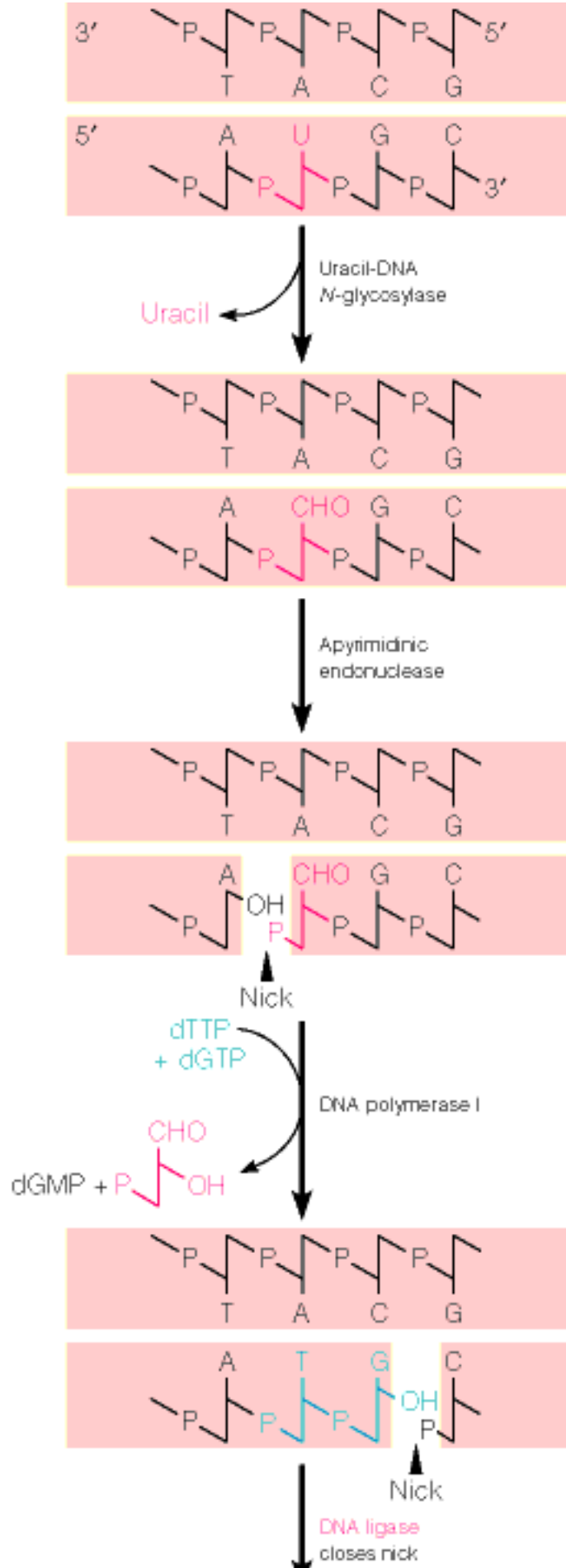

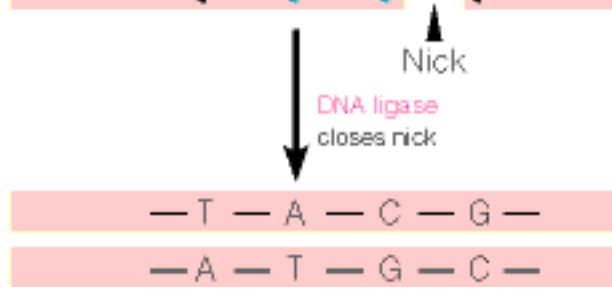

Deoxycytidine Monophosphate (dCMP)

dCMP is a deoxyribonucleotide that is a product of nuclease digestion of [DNA](#).

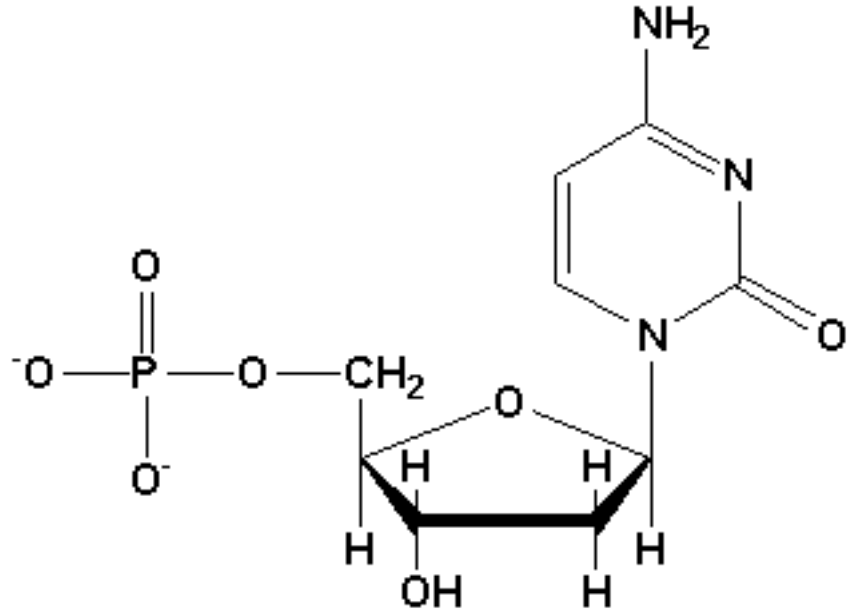

Deoxycytidine Monophosphate (dCMP)

See also: [Nucleotides](#), [Pathways in Nucleotide Metabolism](#)

Base Excision Repair

Base excision repair (BER) is a process that removes one or more nucleotides from a site of base damage. The process initiates with enzymatic cleavage of the glycosidic bond between the damaged base and deoxyribose. The replacement of [uracil](#) by [thymine](#) in DNA by uracil-DNA N-glycosylase (see [here](#)) is an example of **BER**. [Figure 25.13](#) illustrates **BER** of a thymine dimer (see [here](#)), as initiated by endonuclease V of bacteriophage T4. This enzyme has two activities, a glycosylase and an AP endonuclease. The glycosylase cleaves between the thymine on the 5' side of the dimer and its associated [deoxyribose](#). The AP endonuclease, on the other hand, recognizes the apyrimidinic (AP) site, consisting of a deoxyribose without an associated pyrimidine base, and cleaves on its 5' side.

A second cleavage, 3' to that site, by deoxyribophosphodiesterase, releases [deoxyribose-5-phosphate](#). Next, nick translation by [DNA polymerase I](#), followed by [DNA ligase](#), replaces the damaged DNA and closes the nick.

BER often involves separate enzymes for glycosidic cleavage and endonucleolytic cleavage of the abasic site (apyrimidinic or apurinic, depending on the damage).

Most cells contain several DNA-N-glycosylases.

Oxidative damage to DNA is repaired primarily by **BER**. The oxidized base [8-oxoguanine](#), for example, can be removed from DNA by the protein products of the *E. coli* *mutM* and *mutY* genes. The MutM protein removes 8-oxoguanine (and other oxidized bases), while the MutY protein removes [adenine](#) that is mispaired to 8-oxoG ([Figure 25.14](#)).

See also: [Nucleotide Excision Repair](#), [Types and Consequences of DNA Damage](#)

INTERNET LINK: [DNA Repair](#)

Figure 25.13: Base excision repair of thymine dimers.

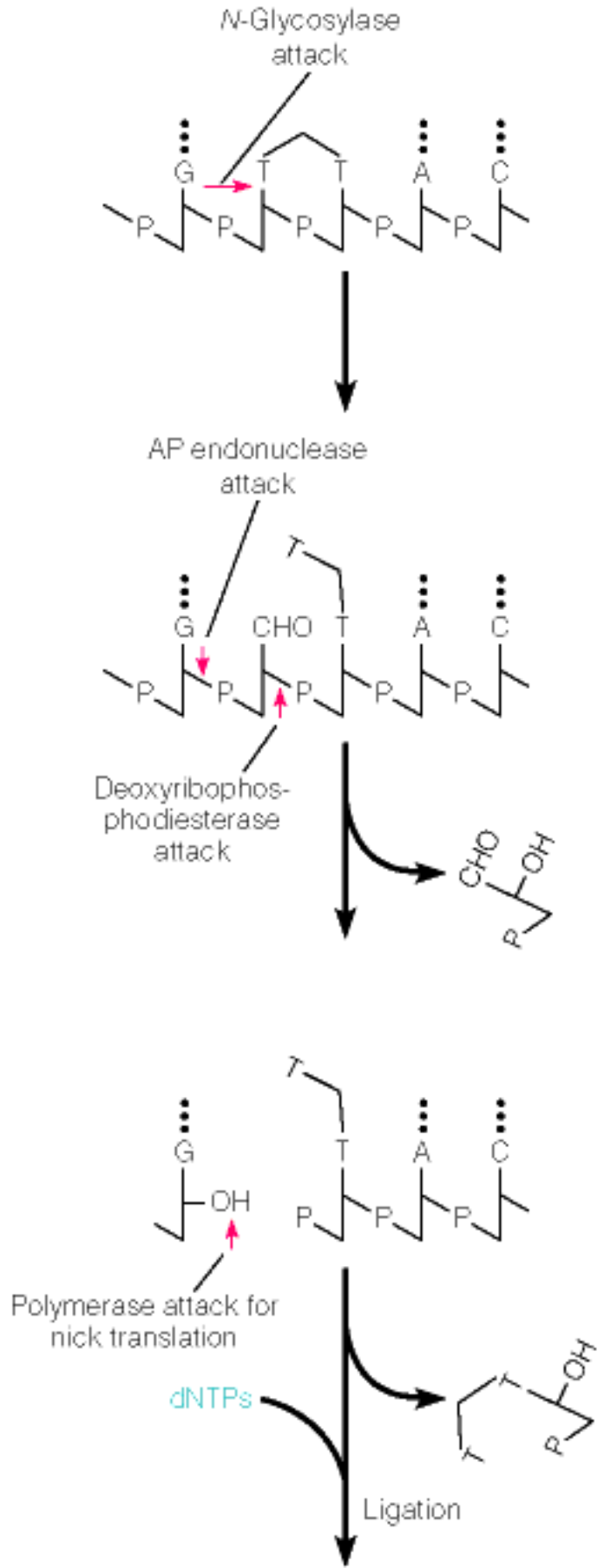

Ligation

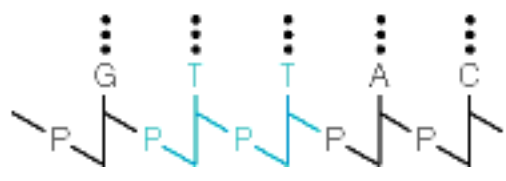

Deoxyribose-5-Phosphate

Deoxyribose-5-phosphate is the product released by deoxyribophosphodiesterase during the process of base excision repair.

See also: [Base Excision Repair](#)

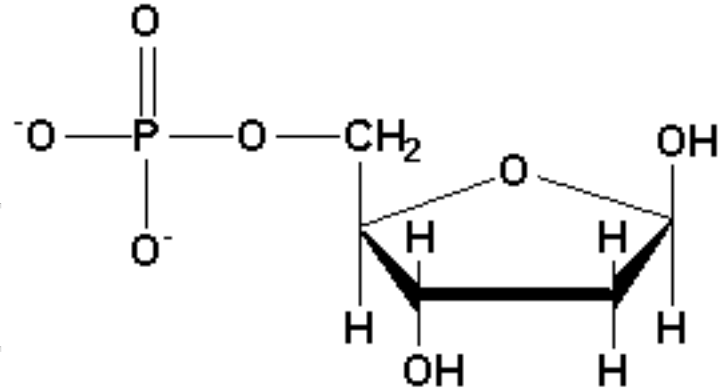

Deoxyribose 5-Phosphate

8-Oxoguanine

8-Oxoguanine is an oxidized form of [guanine](#). In DNA, 8-oxo-guanine can mispair with [adenine](#), potentially forming a mutation. **8-Oxoguanine** can be removed from DNA by the protein products of the *E. coli mutM* and *mutY* genes. The MutM protein removes **8-oxoguanine** (and other oxidized bases), while the MutY protein removes [adenine](#) that is mispaired to **8-oxoguanine** ([Figure 25.14](#)).

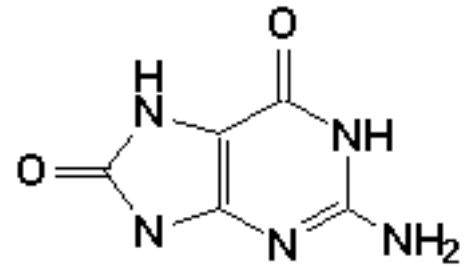

8-Oxoguanine

See also: [Base Excision Repair](#), [Antioxidants](#), [Reactive Oxygen](#), [Oxygen Metabolism and Human Disease](#), [Thymine Glycol](#), [5-Hydroxymethyluracil](#), [DNA](#), [Nucleotides](#)

Figure 25.14: Actions of mutM, mutT, and mutY gene products in countering the mutagenic effect of 8-oxoguanine (oG).

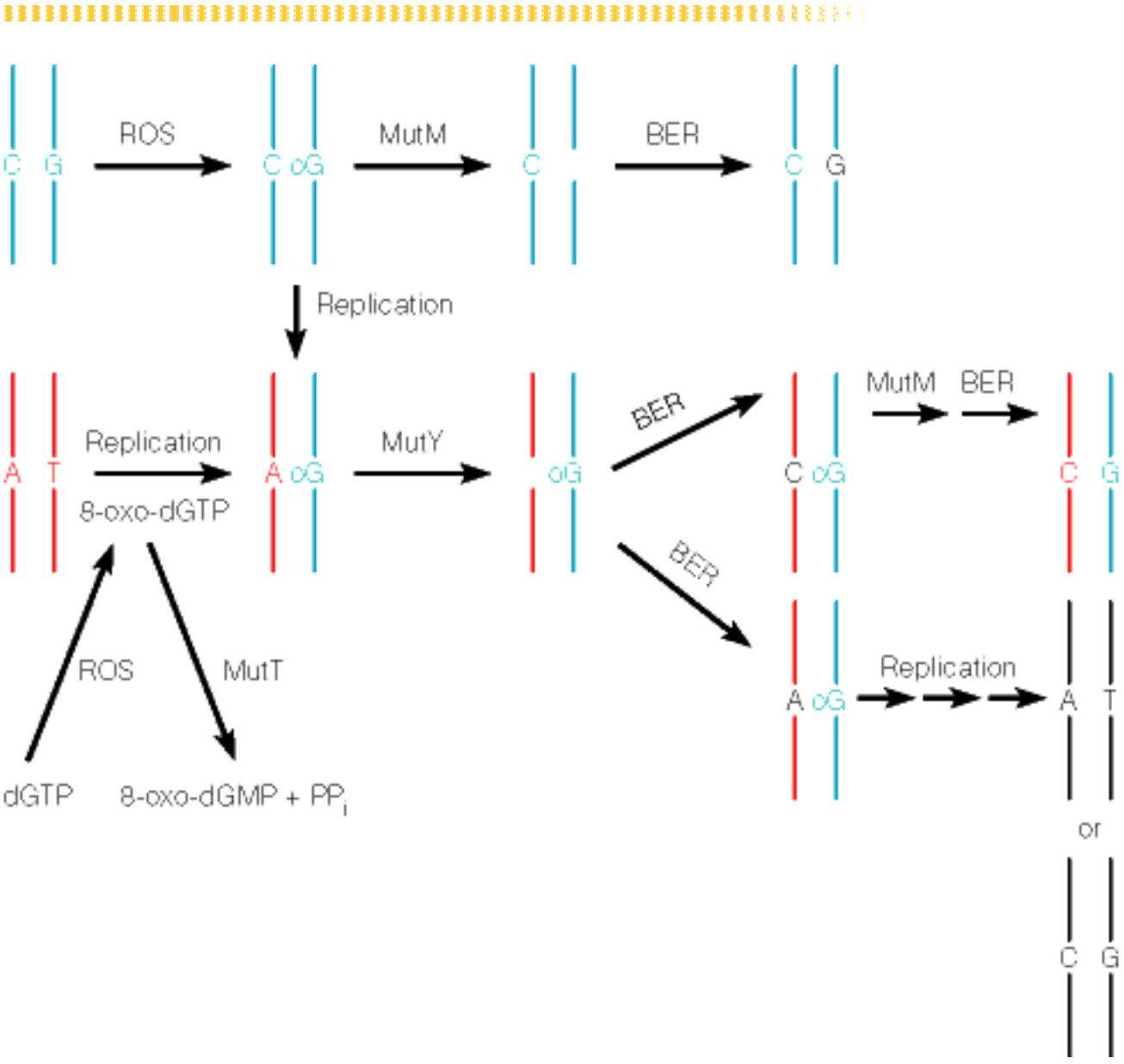

Antioxidants

Antioxidants provide protection against oxidative damage from reactive oxygen species, such as superoxides, hydroxyl radicals, hydrogen peroxide (see [here](#)). Biological compounds that provide such protection include substances, such as [vitamin A](#), [vitamin C](#), and [vitamin E](#), [uric acid](#), [glutathione](#) and enzymes, such as superoxide dismutase, catalase, glutathione peroxidase. Many **antioxidants** act by scavenging reactive oxygen molecules or by chemically reducing oxidized compounds.

See also: [Reactive Oxygen](#), [Oxygen Metabolism and Human Disease](#), [Superoxide Dismutase](#), [Catalase](#), [Glutathione Peroxidase](#)

Reactive Oxygen

Transfer of electrons to oxygen in electron transport by cytochrome oxidase occurs one electron at a time. These kinds of transfers are rarely 100% complete, generating incompletely reduced **oxygen** species. These **oxygen** species include superoxide, formed from a one-electron reduction of O₂; hydrogen peroxide (H₂O₂), generated from a two-electron reduction; and hydroxyl radical, formed via a three-electron reduction. In addition, some enzymes, such as **xanthine oxidase** and amino acid oxidase, generate hydrogen peroxide as ordinary products. Superoxide, hydrogen peroxide, and hydroxyl radical are more reactive than O₂, so they are referred to collectively as reactive oxygen species (ROS).

Hydroxyl Radical - Hydroxyl radical damages proteins, nucleic acids, and the fatty acids in membrane lipids (lipid peroxidation). Lipid peroxidation occurs as a chain reaction. Hydroxyl radical is produced as a result of ionizing radiation and represents the most active mutagen derived from ionizing radiation. It is also produced from H₂O₂ in the Fenton reaction:

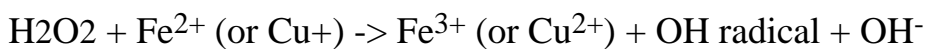

Superoxide - **Superoxide**, in and of itself, is relatively nontoxic. It is a free radical, however, so it combines readily with **nitric oxide**, another free radical that is a biological signaling agent. The product is peroxynitrite (OONO⁻), which is also considered a ROS. Peroxynitrite causes lipid peroxidation and also causes nitration of tyrosyl hydroxyl groups in proteins, a reaction particularly damaging to membrane proteins.

Large scale production of reactive oxygen species has the potential to inflict considerable damage on the tissues in which they are produced, a situation called oxidative stress. Antioxidant compounds, such as glutathione, **vitamin C** and **vitamin E**, and **uric acid** provide non-enzymatic protection against oxidative stress because they can scavenge ROS before the ROS can cause damage. Alternatively, antioxidant compounds can prevent oxidative damage from spreading, such as the chain reaction of lipid peroxidation. Vitamin E is the principal lipid-soluble antioxidant compound and plays an important role in preventing membrane damage. **β-Carotene** and other carotenoid compounds related to **vitamin A** are lipid-soluble antioxidants that also play roles in free radical trapping. **Glutathione** plays an important role in cellular antioxidant protection. Vitamin C (ascorbic acid) is present in far higher amounts in cellular fluids and probably plays the predominant role in extracellular antioxidant protection. A major antioxidant role of uric acid may be its ability to bind and inactivate peroxynitrite.

Enzymatic mechanisms can defend against ROS, too. **Superoxide dismutase** (SOD) is a family of metalloenzymes that catalyze dismutation (reactions in which identical molecules have different fates). The reaction catalyzed is as follows:

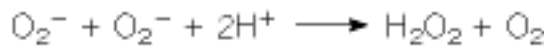

Hydrogen peroxide is metabolized either by catalase or by a more limited family of peroxidases. Catalase catalyzes the following reaction:

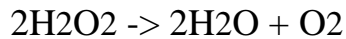

Glutathione peroxidase catalyzes reduction of H₂O₂ as follows:

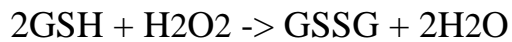

Here GSH is reduced glutathione and GSSG is oxidized glutathione.

Some cells produce ROS as a normal part of their functioning. Certain white blood cells contribute to defense against infectious agents by phagocytosis. Such cells can engulf a bacterial cell, followed by a respiratory burst - a rapid increase in oxygen uptake. Much of the oxygen is reduced to superoxide ion and to H₂O₂, which help to kill the engulfed bacterium.

See also: [Oxygen Metabolism and Human Disease](#), [Antioxidants](#)

Vitamin C (Ascorbic Acid)

Vitamin C is a water-soluble enzyme in the body. It acts as a potent antioxidant, protecting against damage by reactive oxygen species. **Vitamin C** also has a role in making cross links between amino acids in collagen.

Collagen is unusual in its widespread modification of proline to hydroxyproline and lysine to hydroxylysine. Most of the hydrogen bonds between chains in the triple helix are from amide protons to carbonyl oxygens, but the OH groups of hydroxyproline also seem to participate in stabilizing the structure. Hydroxylysine residues in collagen serve to form attachment sites for polysaccharides.

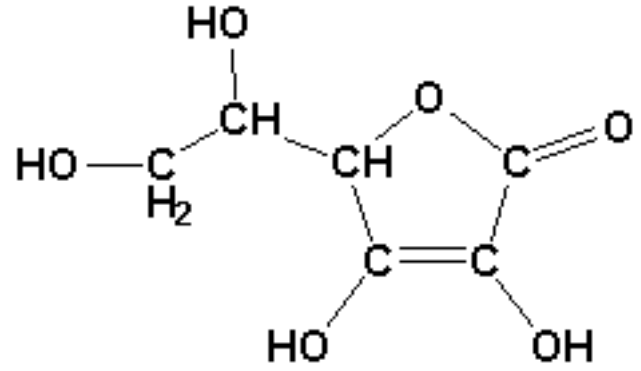

Ascorbate

The hydroxylation reactions in collagen involve **vitamin C**. A symptom of extreme **vitamin C** deficiency, called scurvy, is the weakening of collagen fibers caused by the failure to hydroxylate proline and lysine. Consequences are as might be expected: Lesions develop in skin and gums, and blood vessels weaken. The condition quickly improves with administration of **vitamin C**.

See also: [Antioxidants](#), [Reactive Oxygen](#), [Oxygen Metabolism and Human Disease](#), [Glutamate as a Precursor of Other Amino Acids](#) (from Chapter 21), [Vitamins](#)

INTERNET LINK: [Ascorbate Metabolism](#)

Collagen

Because it performs such a wide variety of functions, **collagen** is the most abundant single protein in most vertebrates. In large animals, it may make up a third of the total protein mass. **Collagen** fibers form the matrix, or cement, material in bone, on which the mineral constituents precipitate. These fibers constitute the major portion of tendons. A network of **collagen** fibers is an important constituent of skin. Basically, **collagen** holds most animals together.

The basic unit of the **collagen** fiber is the tropocollagen molecule, a triple helix of three polypeptide chains, each about 1000 residues in length. This 3-fold helical structure, shown schematically in [Figure 6.13](#), is unique to **collagen**. The individual chains are left-hand helices, with about 3.3 residues/turn. Three of these chains wrap around one another in a right-hand sense, with hydrogen bonds extending between the chains.

Examination of the model reveals that every third residue, which must lie near the center of the triple helix, can be only [glycine](#) ([Figure 6.13a](#)). Any side chain would be too bulky. Formation of the individual helices of the **collagen** type is also favored by the presence of or hydroxyproline in the tropocollagen molecule. A repetitive theme in the sequence is of the form Gly - X - Y, where X is often [proline](#) and Y is proline or [hydroxyproline](#). However, other residues are sometimes tolerated in these positions. Like silk fibroin, **collagen** is a good example of how a particular kind of repetitive sequence dictates a particular structure.

[Hydroxylysine](#) is a modified amino acid that also occurs in **collagen**.

See also: [Hydrogen Bonds](#), [Collagen Synthesis](#), [Fibrous Proteins](#)

Figure 6.13: The structure of collagen fibers.

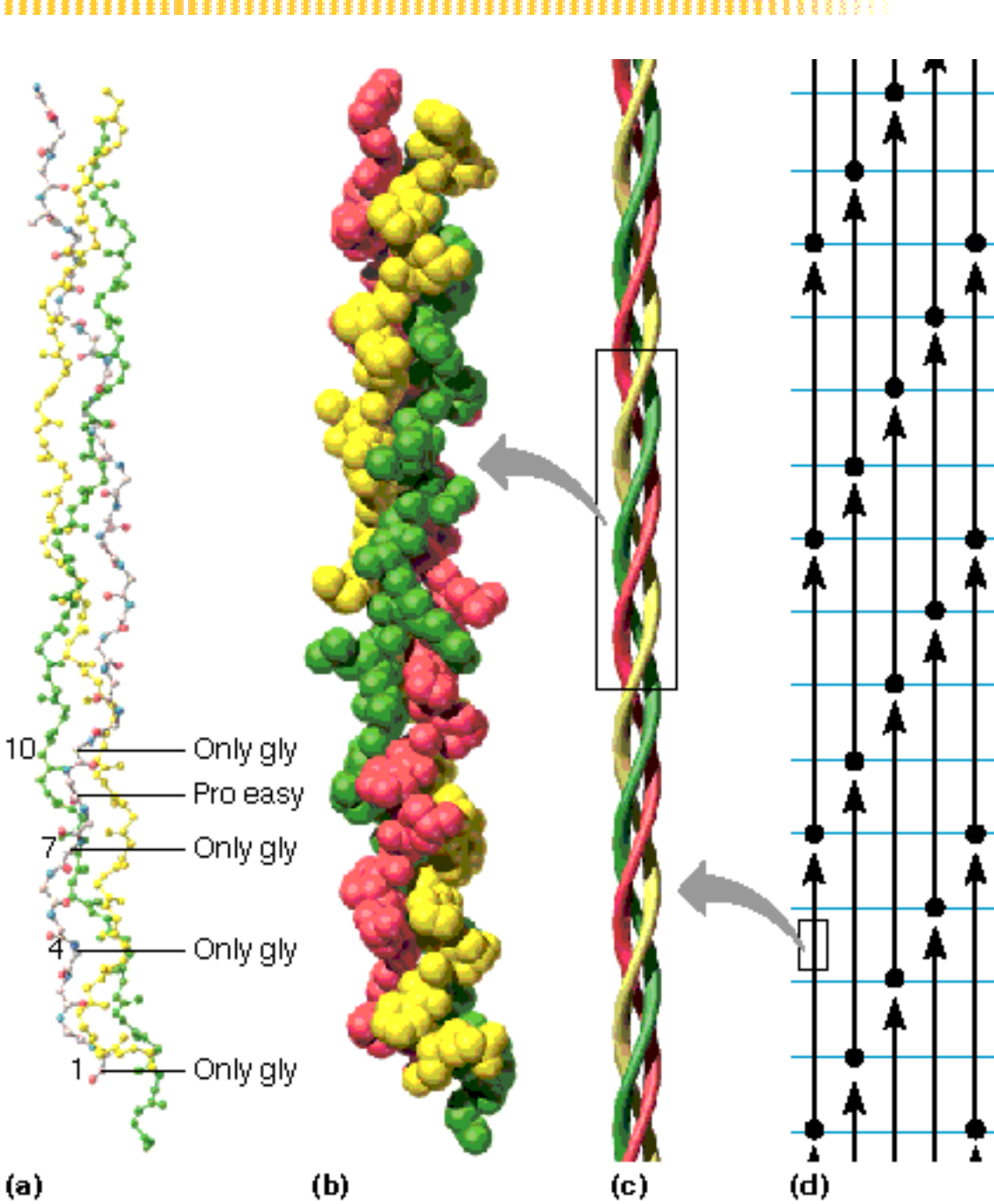

Proline

Proline is an α **amino acid** found in proteins. In mammals, **proline** is a non-essential amino acid, meaning it does not need to be present in the diet. **Proline** is hard to classify due to its ring structure, but it shares many properties of the aliphatic amino acids.

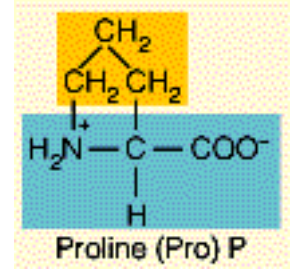

One Letter Code	Three Letter Code	Molecular Wt. (Daltons)	Genetic Code Codons
P	PRO	97.12	CCU, CCC, CCG, CCA

See also: [Table 5.1](#), , [Genetic Code](#), [Glutamate as a Precursor of Other Amino Acids](#), [Essential Amino Acids](#)

INTERNET LINK: [Proline Metabolism](#)

4-Hydroxyproline

The protein collagen is unusual in its widespread modification of **proline** to **4-hydroxyproline** (also called **hydroxyproline**). The OH groups of **hydroxyproline** participate in stabilizing the structure. Hydroxylation of **lysine** residues in collagen also occurs but is much less frequent. It plays a different role, serving to form attachment sites for **polysaccharides**.

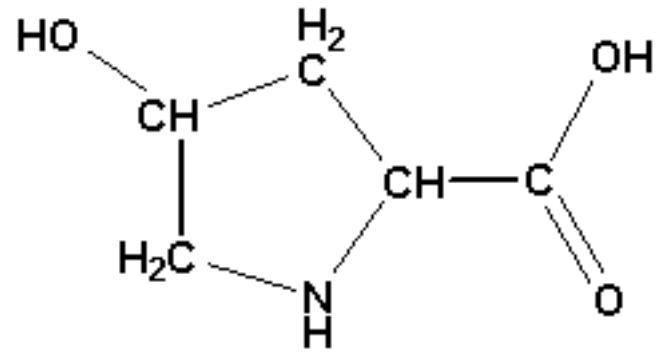

Hydroxyproline

Hydroxyproline residues are generated by posttranslational modification, following completion of the polypeptide chain. The nonhydroxylated collagen precursor is called procollagen (**Figure 6.14**, **Figure 21.4**). In this polypeptide, a proline residue two positions to the carboxyl side of a glycine residue is the preferred substrate for the action of procollagen proline hydroxylase (**Figure 21.4**). This unusual enzyme requires ferrous iron, **ascorbic acid**, molecular oxygen, and α -**ketoglutarate**. The last substance is oxidized during the reaction to **succinate** and CO₂. One of the atoms from O₂ is incorporated into succinate, and the other ends up in the hydroxyproline hydroxyl group.

See also: **Proline**, **Collagen**, **Modified Amino Acids in Proteins**, **Glutamate as a Precursor of Other Amino Acids** (from Chapter 21)

Figure 6.14: Biosynthesis and assembly of collagen.

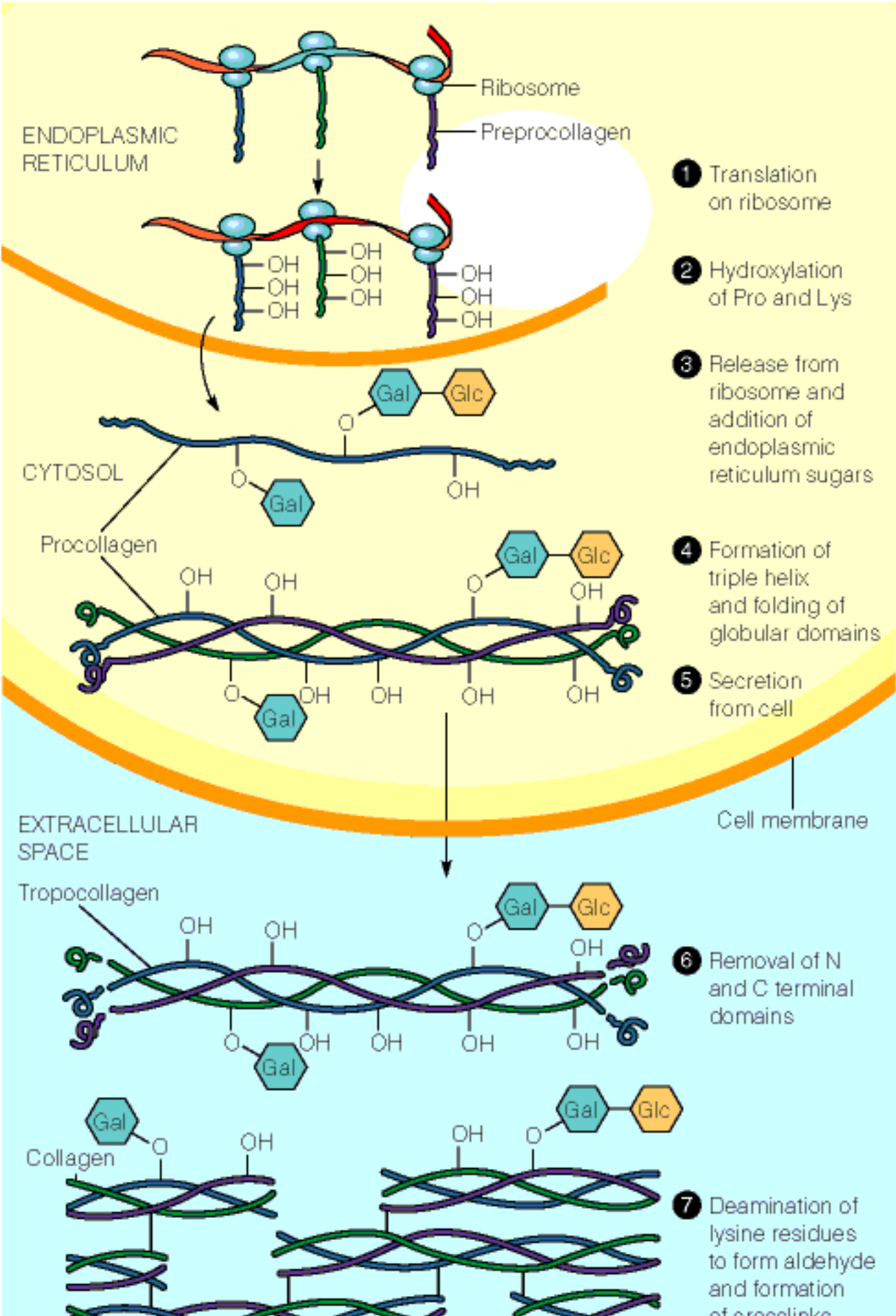

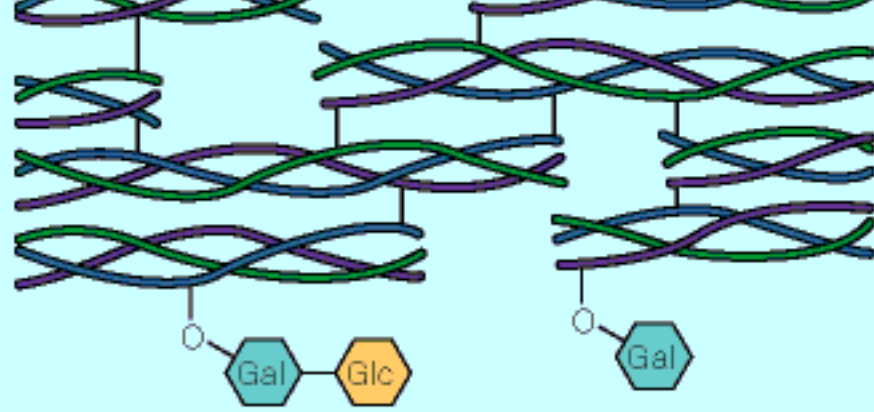

Deamination of lysine residues to form aldehyde and formation of crosslinks

Figure 21.4: Enzymatic hydroxylation of procollagen proline residues in the synthesis of collagen.

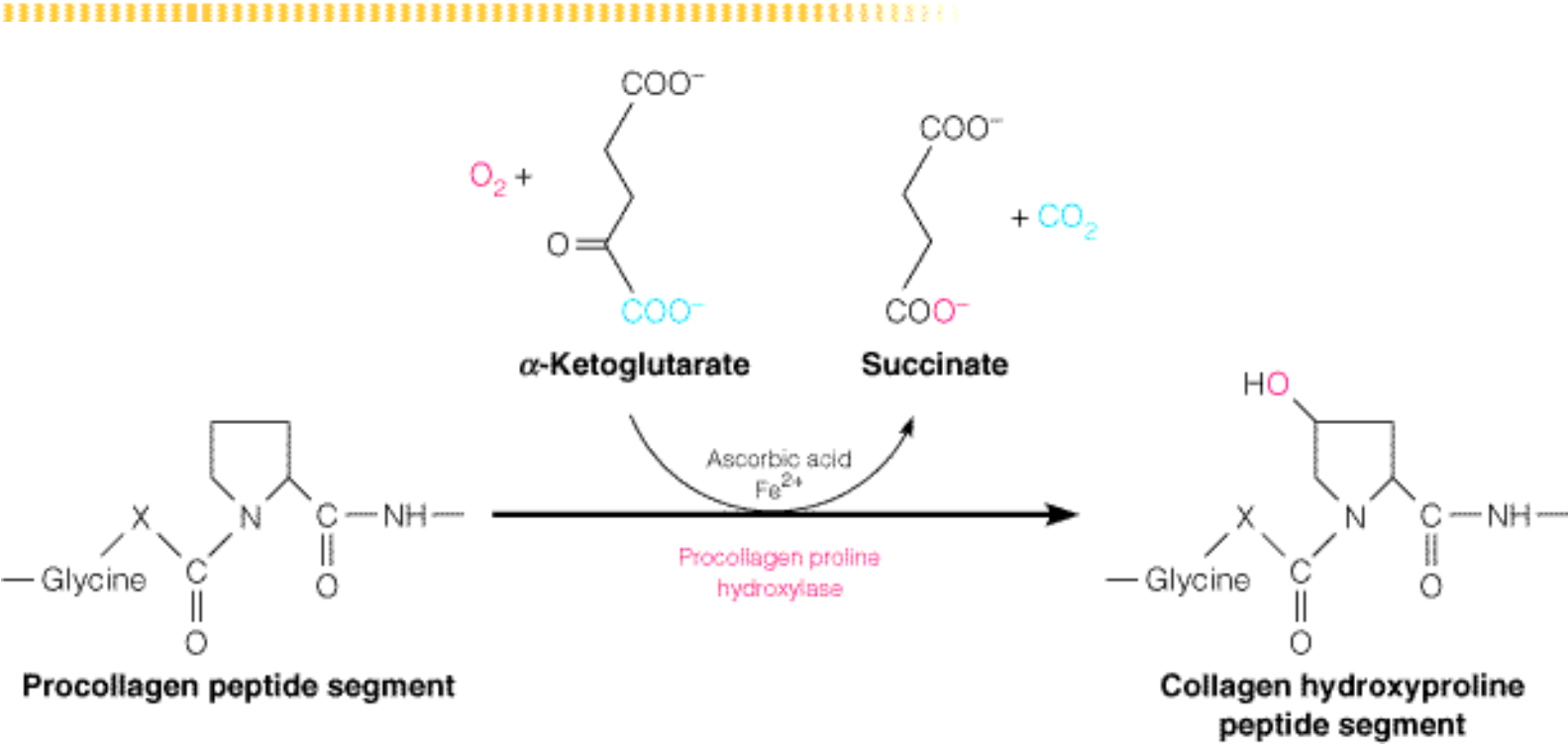

Modified Amino Acids in Proteins

Some amino acids are chemically **modified** after they are incorporated into proteins. The results of these modifications produce the following residues found in proteins, O-Phosphoserine, 4-Hydroxyproline, δ -Hydroxylysine, thyroxine and γ -Carboxyglutamic acid.

See also: O-Phosphoserine, 4-Hydroxyproline, δ -Hydroxylysine, Thyroxine, γ -Carboxyglutamic acid

O-Phosphoserine

O-Phosphoserine is a modified form of [serine](#) found in proteins as a result of phosphorylation by a protein kinase (an enzyme which puts phosphates onto proteins).

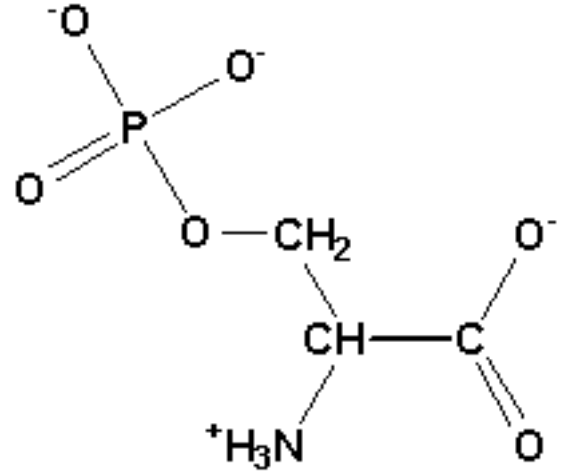

O-phosphoserine

See also: [Modified Amino Acids in Proteins](#)

5-Hydroxylysine

5-Hydroxylysine (also called δ -hydroxylysine) is a modified form of [lysine](#) found in [collagen](#).

See also: [Modified Amino Acids in Proteins](#)

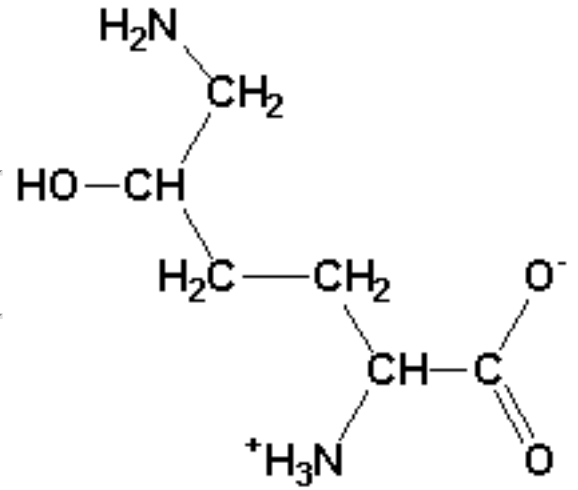

Hydroxylysine

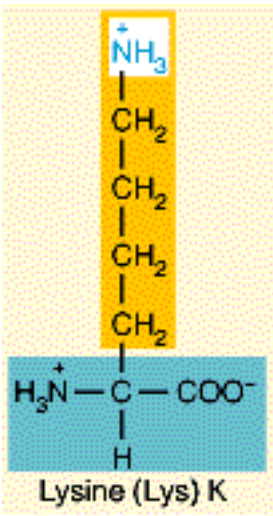

Thyroxine

Thyroxine and **triiodothyronine** are thyroid hormones made by modifying **tyrosine** residues in the protein, **thyroglobulin** (**Figure 21.19**). Degradation of thyroglobulin yields the free hormones. Synthesis occurs in the thyroid gland, which concentrates iodide from the blood.

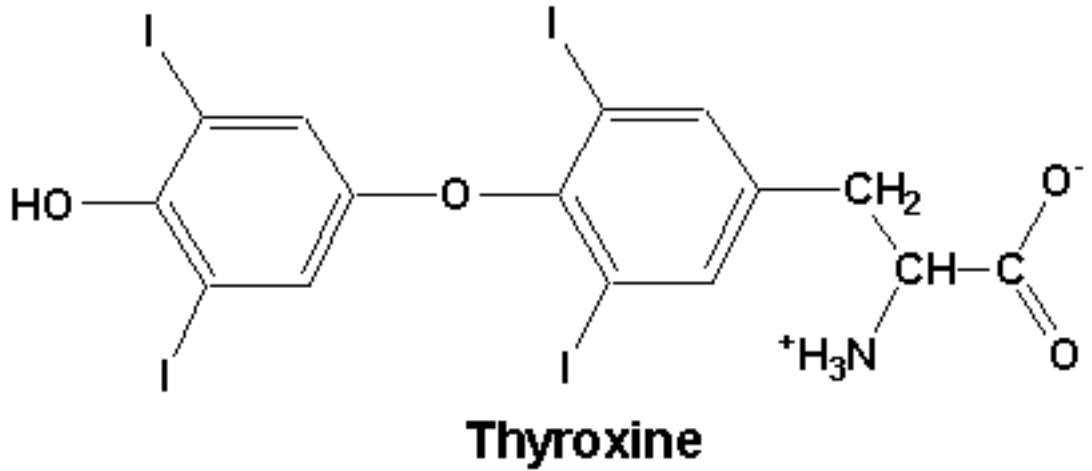

See also: [Aromatic Amino Acid Utilization](#), [Modified Amino Acids in Proteins](#)

Triiodothyronine

Thyroxine and **triiodothyronine** are thyroid hormones made by modifying tyrosine residues in the protein, **thyroglobulin** ([Figure 21.19](#)). Degradation of **thyroglobulin** yields the free hormones. Synthesis occurs in the thyroid gland, which concentrates iodide from the blood.

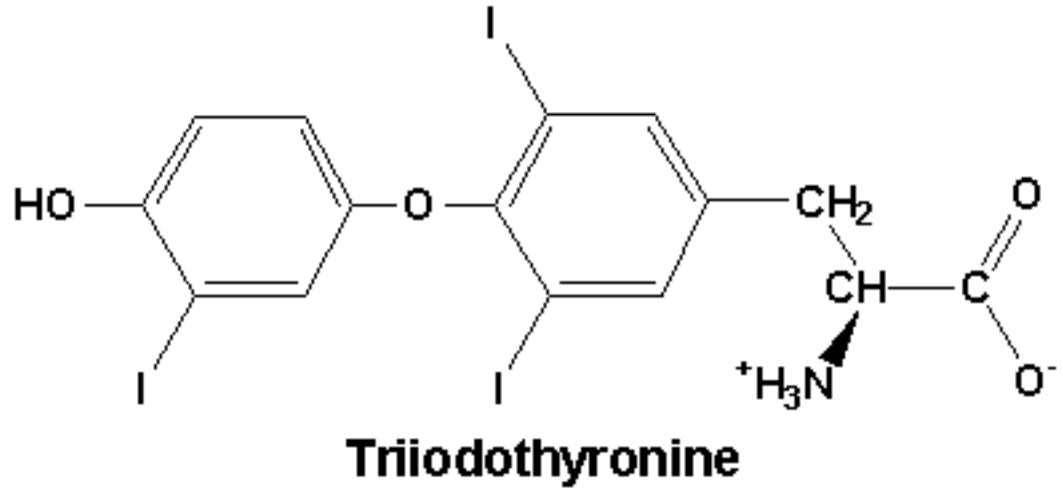

See also: [Thyroxine](#), [Thyroglobulin](#), [Aromatic Amino Acid Utilization](#)

Figure 21.19: Biosynthesis of thyroid hormones as residues in the protein thyroglobulin.

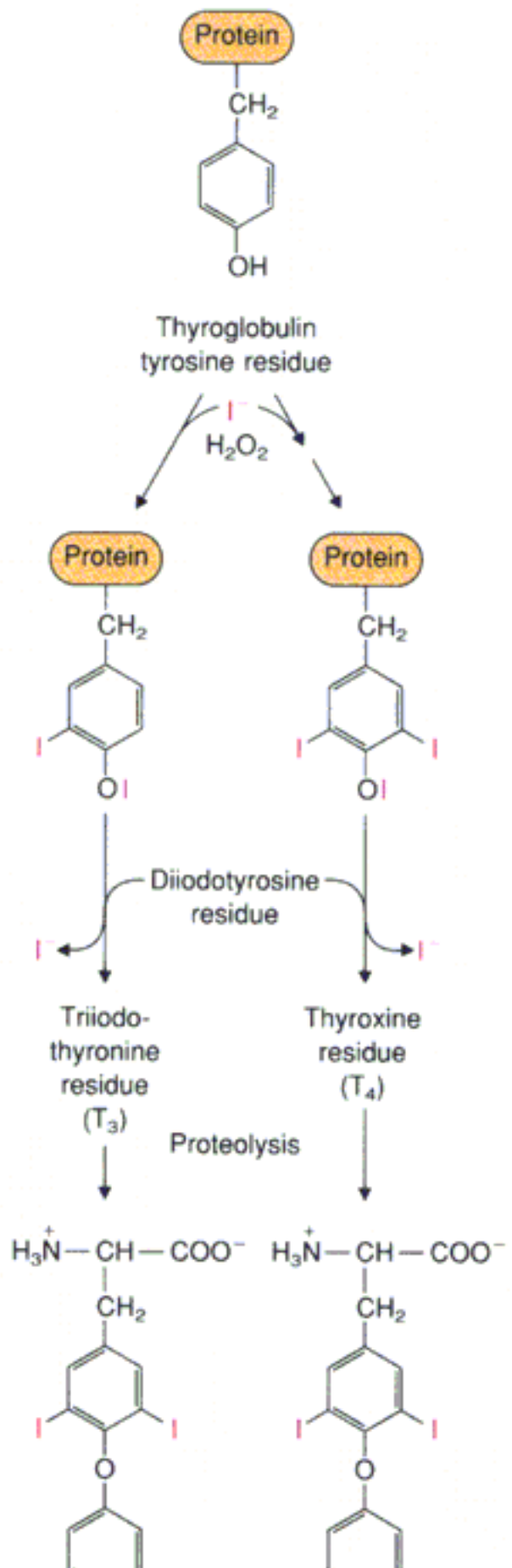

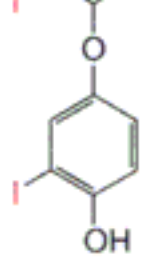

Triiodothyronine
(T₃)

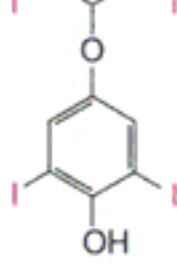

Thyroxine
(T₄)

Thyroglobulin

Thyroxine and **triiodothyronine** are thyroid hormones made by modifying **tyrosine** residues in the protein, **thyroglobulin** (**Figure 21.19**). Degradation of **thyroglobulin** yields the free hormones. Synthesis occurs in the thyroid gland, which concentrates iodide from the blood.

See also: [Aromatic Amino Acid Utilization](#)

Aromatic Amino Acid Utilization

Aromatic amino acids are precursors of many compounds in plants and animals. They include:

Plants - **Lignin**, tannins, and pigments, flavor components of spices (cinnamon oil, wintergreen oil, bitter almond, nutmeg, cayenne pepper, vanilla bean, clove, and ginger) are derived from **coniferyl alcohol**. Coniferyl alcohol, in turn, is derived from **phenylalanine** and **tyrosine**. Phenylalanine is also a precursor of plant pigments and related polyphenolic compounds called flavonoids. The biosynthetic scheme leads to a class of flavonoids called anthocyanins, which are common flower pigments.. An offshoot of this pathway leads to the synthesis of cocaine.

Finally, **tryptophan** is used for the synthesis of indole-3-acetic acid (see **here**), a plant hormone also known as auxin.

Animals - Animal cells do not synthesize aromatic rings. Instead, animal cells extensively modify amino acids with aromatic rings. Examples include the synthesis of tyrosine from phenylalanine, the synthesis of pigments and hormones from tyrosine, and the use of tyrosine, tryptophan, and **histidine** in synthesis of biogenic amines - compounds that serve as hormones and **neurotransmitters**.

Tyrosine biosynthesis (**Figure 21.18**) - **Tyrosine** is the only aromatic amino acid made in animals. The reaction is catalyzed by **phenylalanine hydroxylase**, a mixed-function oxidase using tetrahydrobiopterin, a pteridine co-factor.



Deficiency of phenylalanine hydroxylase is responsible for phenylketonuria (PKU), an autosomal recessive disease that results in the accumulation of too much phenylalanine, because the synthesis of tyrosine is blocked.

Tyrosine utilization - Tyrosine serves as a precursor to thyroid hormones, melanins (biological pigments - **Figure 21.20**), and **catecholamines** (hormones and neurotransmitters). **Thyroxine** and **triiodothyronine** are thyroid hormones made by modifying tyrosine residues in the protein, **thyroglobulin** (**Figure 21.19**). Degradation of thyroglobulin yields free hormones. Synthesis occurs in the thyroid gland, which concentrates iodide from the blood. Melanin synthesis occurs in melanocytes (**Figure 21.20**).

An individual's skin color is determined by the relative amounts of red and black melanins in the skin.

Tyrosine Catabolism - The catabolism of tyrosine to [fumarate](#) and [acetoacetate](#) is depicted in [Figure 21.21](#). A hereditary deficiency of the enzyme homogentisic acid dioxygenase causes a disease called alkaptonuria where [homogentisic acid](#) accumulates and is excreted in large amounts in the urine. It oxidizes on standing, causing the urine to become dark.

Tryptophan - ([Figure 21.22](#)) - Tryptophan is catabolized to either [glutaryl-CoA](#) and [acetoacetyl-CoA](#) (major route) or [NAD⁺](#). [NAD⁺](#) can also be made from nicotinic acid ([Table 11.5](#)).

Histidine - Decarboxylation of histidine yields histamine (see [here](#)). In the stomach, histamine promotes secretion of hydrochloric acid and pepsin as digestion aids. Histamine is a potent vasodilator, released at sites of trauma, inflammation, or allergic reaction. Reddening of inflamed tissues is a result of local enlargement of blood capillaries. Antihistamines block binding of histamine to its receptors. [Figure 21.23](#) shows that histidine is catabolized to [glutamate](#).

See also: [Metabolism of Aromatic Amino Acids and Histidine](#), [Neurotransmitters and Biological Regulators](#)

Coniferyl Alcohol

Coniferyl alcohol is a plant metabolite that is a precursor to both lignin and a number of flavor constituents. It arises from action of specific lyases, which cleave out ammonia from [phenylalanine](#) and [tyrosine](#) ([Figure 21.12](#)).

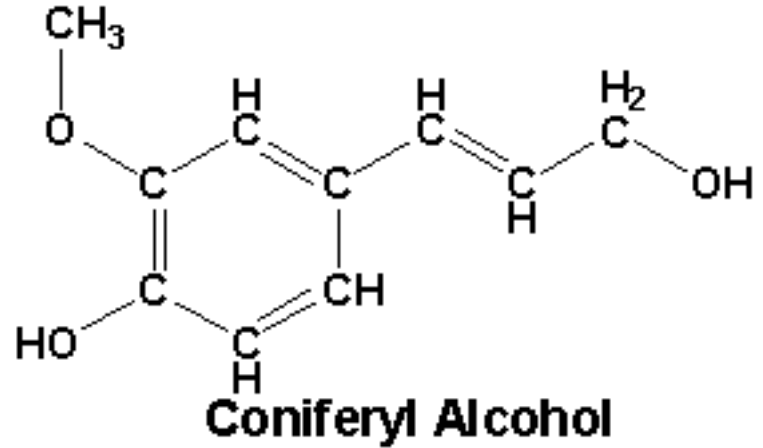

Lignin, tannins, pigments, and flavor components of spices (cinnamon oil, wintergreen oil, bitter almond, nutmeg, cayenne pepper, vanilla bean, clove, and ginger) are all derived from **coniferyl alcohol**, which is also the central intermediate in lignin synthesis.

See also: [Aromatic Amino Acid Utilization](#)

Unnumbered Item

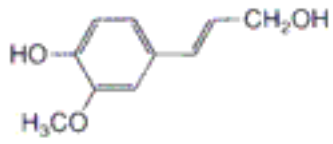

Coniferyl alcohol

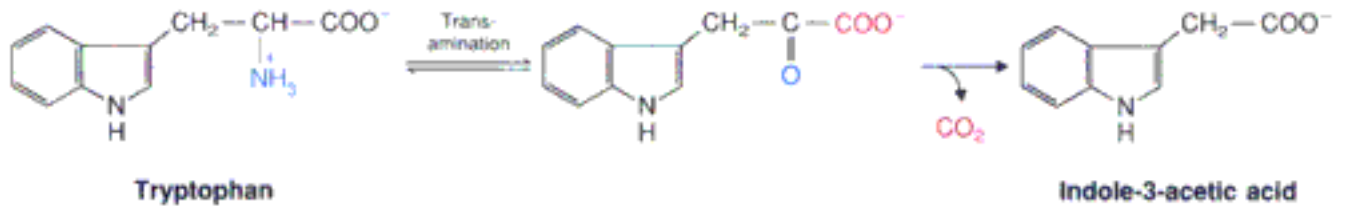

Dihydrobiopterin

Dihydrobiopterin is the oxidized form of tetrahydrobiopterin, an electron carrier in tyrosine biosynthesis ([Figure 21.18](#)). Tyrosine is only aromatic amino acid made in animals. The reaction is catalyzed by phenylalanine hydroxylase.

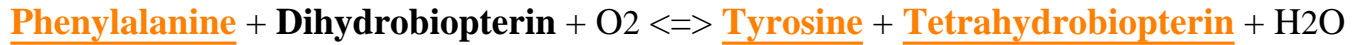

Deficiency of phenylalanine hydroxylase is responsible for phenylketonuria (PKU), an autosomal recessive disease that results in production of too much phenylalanine, due to the block in synthesis of tyrosine.

See also: [Phenylalanine Hydroxylase](#), [Aromatic Amino Acid Utilization](#)

INTERNET LINKS:

1. [Phenylalanine, Tyrosine, and Tryptophan Biosynthesis](#)
 2. [Tyrosine Metabolism](#)
-

Figure 21.20: Biosynthetic pathways from tyrosine to melanins.

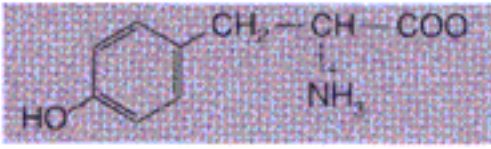

Tyrosine

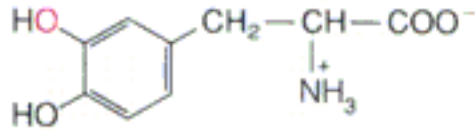
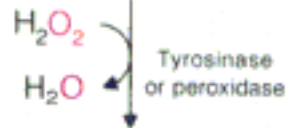

3,4-Dihydroxyphenylalanine (Dopa)

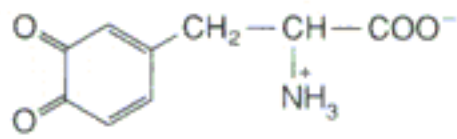
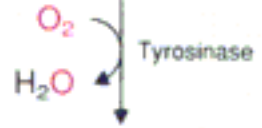

Dopaquinone

Nonenzymatic

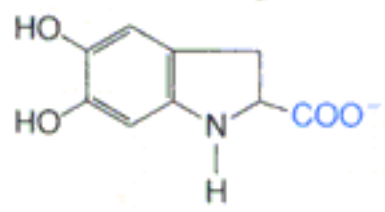

Leucodopachrome

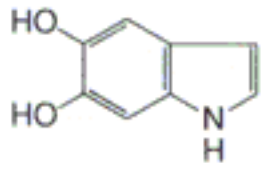

5,6-Dihydroxyindole

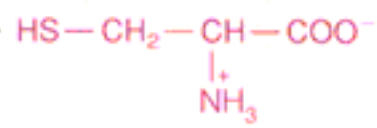

Cysteine

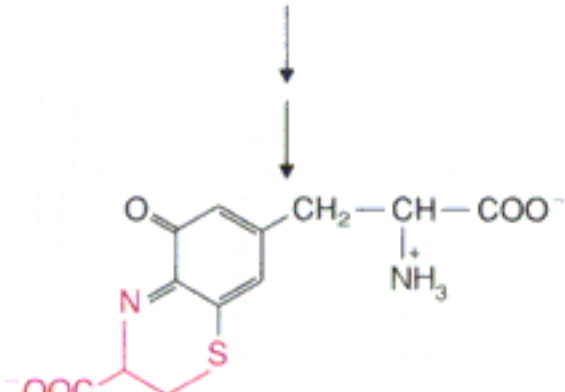
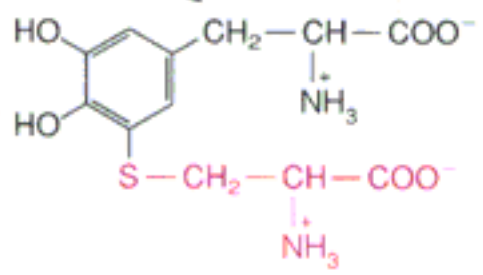

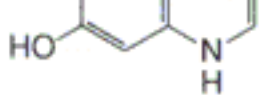

5,6-Dihydroxyindole

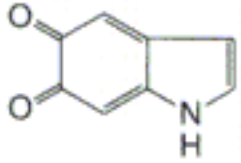
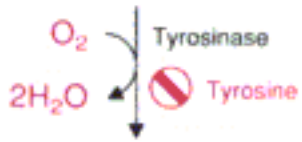

Indole-5,6-quinone

Melanochrome

Polymeric black melanins

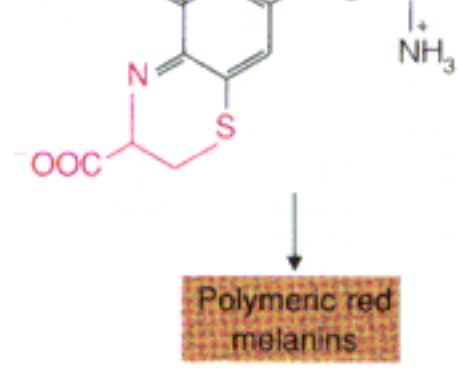

Acetoacetate

Acetoacetate is a **ketone body** that participates in numerous metabolic reactions. Enzymes acting on it include HMG-CoA lyase, β -hydroxybutyrate dehydrogenase, and acetoacetate decarboxylase

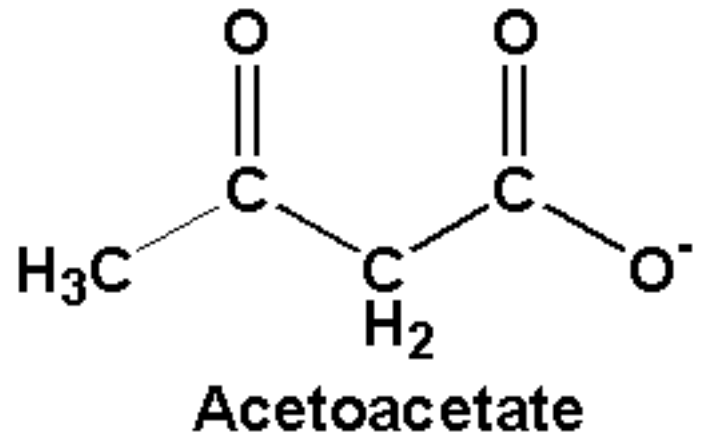

Acetoacetate will also readily undergo uncatalyzed decarboxylation to form acetone and CO₂.

Acetoacetate is also produced in tyrosine catabolism by hydrolysis of fumarylacetoacetate ([Figure 21.21](#)), and is a metabolic end product of leucine and lysine catabolism (see [here](#)).

See also: [HMG-CoA Lyase](#), [\$\beta\$ -Hydroxybutyrate Dehydrogenase](#), [Metabolism of Aromatic Amino Acids](#) (from Chapter 21), [Figure 18.21](#)

β -Hydroxy- β -Methylglutaryl-CoA (HMG-CoA)

HMG-CoA is formed in cells as a product of a reaction catalyzed by HMG-CoA synthase. The molecule has two primary metabolic fates. One pathway, which leads to ketone bodies, occurs in the mitochondria. It starts with a reaction catalyzed by HMG-CoA lyase.

Another pathway involving **HMG-CoA** leads to formation (ultimately) of cholesterol and other steroids. It occurs in the cytoplasm and is initiated by a reaction catalyzed by HMG-CoA reductase.

See also: Figure 18.21

Hydroxy-Methyl-Glutaryl-CoA Synthase (HMG-CoA Synthase)



HMG-CoA Synthase catalyzes the reaction below:



This reaction is important in ketogenesis and in cholesterol metabolism, because HMG-CoA is a branch point between the two pathways.

See also: [Ketogenesis](#), [Ketone Bodies](#), [Figure 18.21](#)

HMG-CoA Lyase

HMG-CoA lyase is a mitochondrial enzyme responsible for catalyzing the reaction below:



This reaction is a step in the formation of ketone bodies (See [Figure 18.21](#)). Notably, HMG-CoA is also an intermediate in cholesterol biosynthesis, which occurs in the cytoplasm

See also: [Ketogenesis](#), [Ketone Bodies](#)

Figure 21.21: Catabolism of tyrosine to fumarate and acetoacetate.

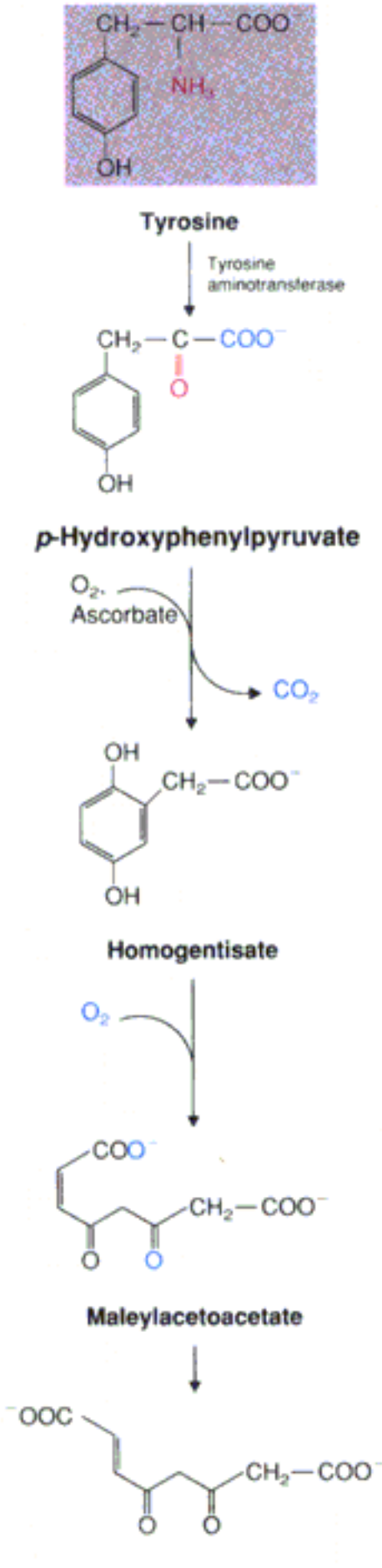

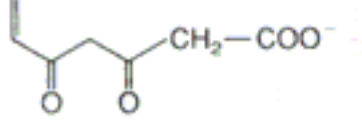

Fumarylacetoacetate

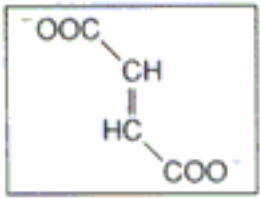

Fumarate

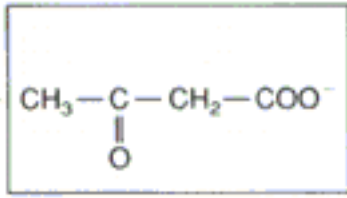

Acetoacetate

β -Hydroxybutyrate Dehydrogenase



β -Hydroxybutyrate dehydrogenase catalyzes the reaction below:

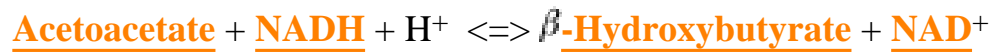

The reaction is important in ketone body metabolism.

See also: [Ketone Bodies](#), [Figure 18.21](#)

β -Hydroxybutyrate

β -Hydroxybutyrate is a ketone body. The compound is referred to as a ketone body even though it does not contain a carbonyl group.

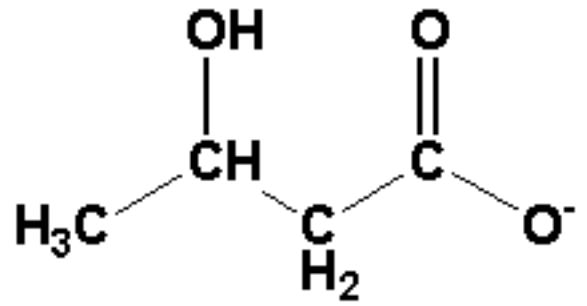

beta-hydroxybutyrate



See also: [Figure 18.21](#), [Ketogenesis](#), [Ketone Bodies](#)

HMG-CoA Reductase

HMG-CoA reductase is the most important regulatory enzyme for the cholesterol biosynthetic pathway and other isoprenoids/terpenoids. **HMG-CoA reductase** catalyzes the reaction that follows:



HMG-CoA reductase is a target for drugs that attempt to lower **cholesterol** levels in the body. One such drug is **lovastatin**, which inhibits the enzyme and stops endogenous synthesis of cholesterol

See also: [Cholesterol Biosynthesis](#), [Figure 19.18](#), [Figure 19.19](#), [Protein Kinase C](#)

INTERNET LINKS:

1. [Sterol Biosynthesis](#)
 2. [Terpenoid Biosynthesis](#)
-

Mevalonic Acid (Mevalonate)

Mevalonate is an intermediate in isoprenoid biosynthesis. It is product of the reaction catalyzed by **HMG-CoA reductase**, as follows:

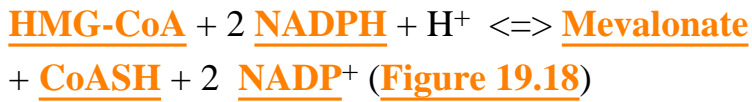

Subsequently, **mevalonate** is converted to 5-phosphomevalonate, as shown in **Figure 19.19**.

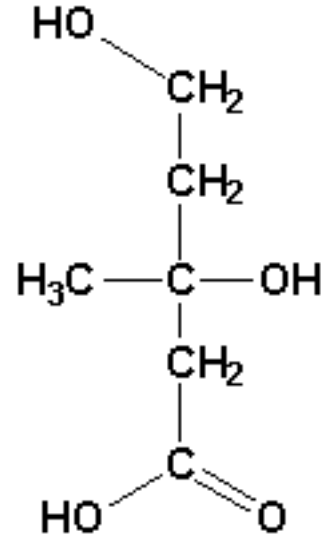

Mevalonic Acid (mevalonate)

See also: [Steroid Metabolism](#), [Cholesterol Biosynthesis](#)

INTERNET LINKS:

1. [Terpenoid Biosynthesis](#)
 2. [Sterol Biosynthesis](#)
-

Figure 19.19: Conversion of mevalonate to isopentenyl pyrophosphate and dimethylallyl pyrophosphate.

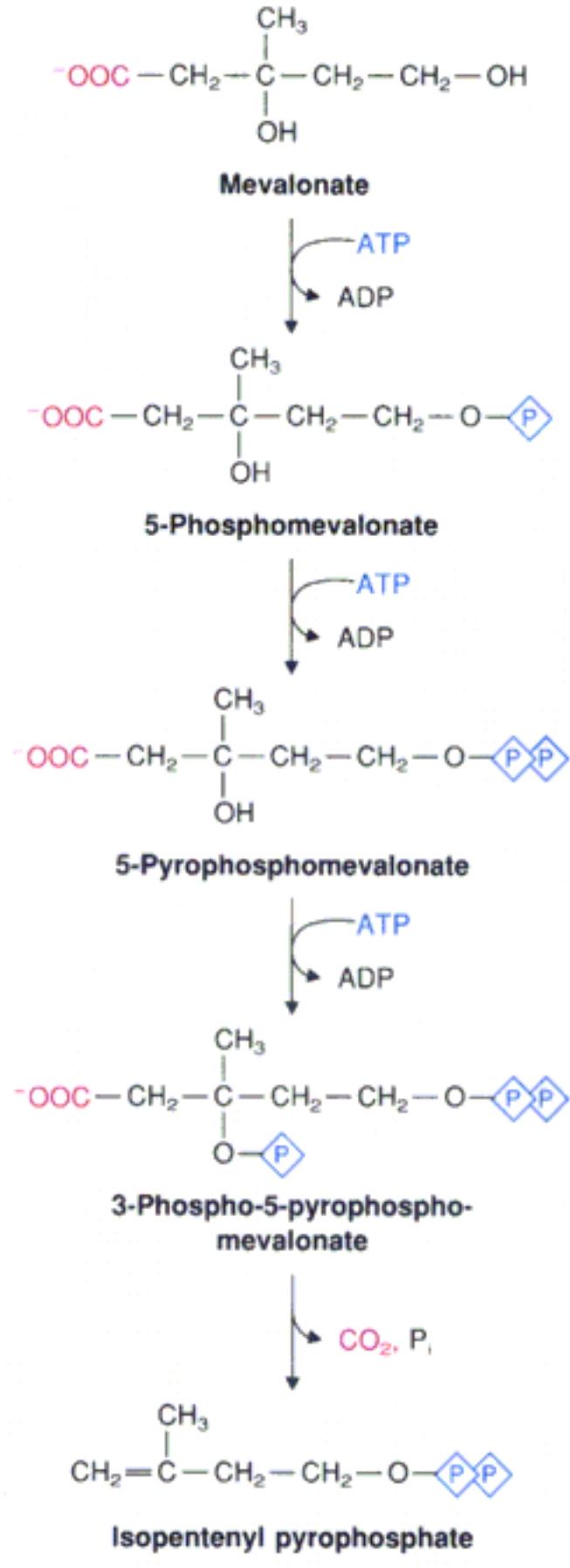

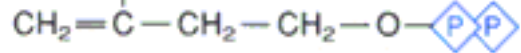

Isopentenyl pyrophosphate

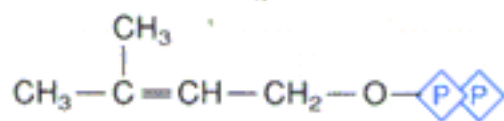

**Dimethylallyl
pyrophosphate**

Bile Acids

Bile acids are derived from [cholesterol](#) and have detergent properties which aid in fat digestion and absorption ([Figure 18.4](#)). **Bile acid** synthesis is the major metabolic end product of cholesterol, accounting for about half of the 800 mg/day that is made in the body. By contrast, synthesis of steroid hormones from cholesterol requires only about 50 mg/day of cholesterol. Although the body synthesizes about 400 mg of bile acids per day, closer to 20-30g of bile acids per day are secreted into the upper small intestine. To meet this need, the body recycles bile acids from the lower small intestine to the liver via enterohepatic circulation.

Bile acids are eliminated in the feces but, due to recycling, only about 0.5g/day or less are eliminated in this way.

[Cholic acid](#) and [chenodeoxycholic acid](#) are the predominant **bile acids** in humans. The **bile acid** deoxycholate is abundant in the bile of some other mammals. Conjugates of cholic acid with [glycine](#) and [taurine](#) form salts called [glycocholate](#) and [taurocholate](#), respectively.

Synthesis of **bile acids** and salts from cholesterol is shown in [Figure 19.23](#). These reactions involve enzymes called microsomal P450 mixed-function oxidases. The first reaction, in which cholesterol is converted to 7- α -hydroxycholesterol, is the rate limiting step.

See also: [Cholesterol Biosynthesis](#), [Bile Salts](#), [Bile Salts and Emulsion of Fats](#) (from Chapter 18), [Deoxycholic Acid](#)

INTERNET LINK: [Bile Acid Biosynthesis](#)

Figure 18.4: Action of bile salts in emulsifying fats in the intestine.

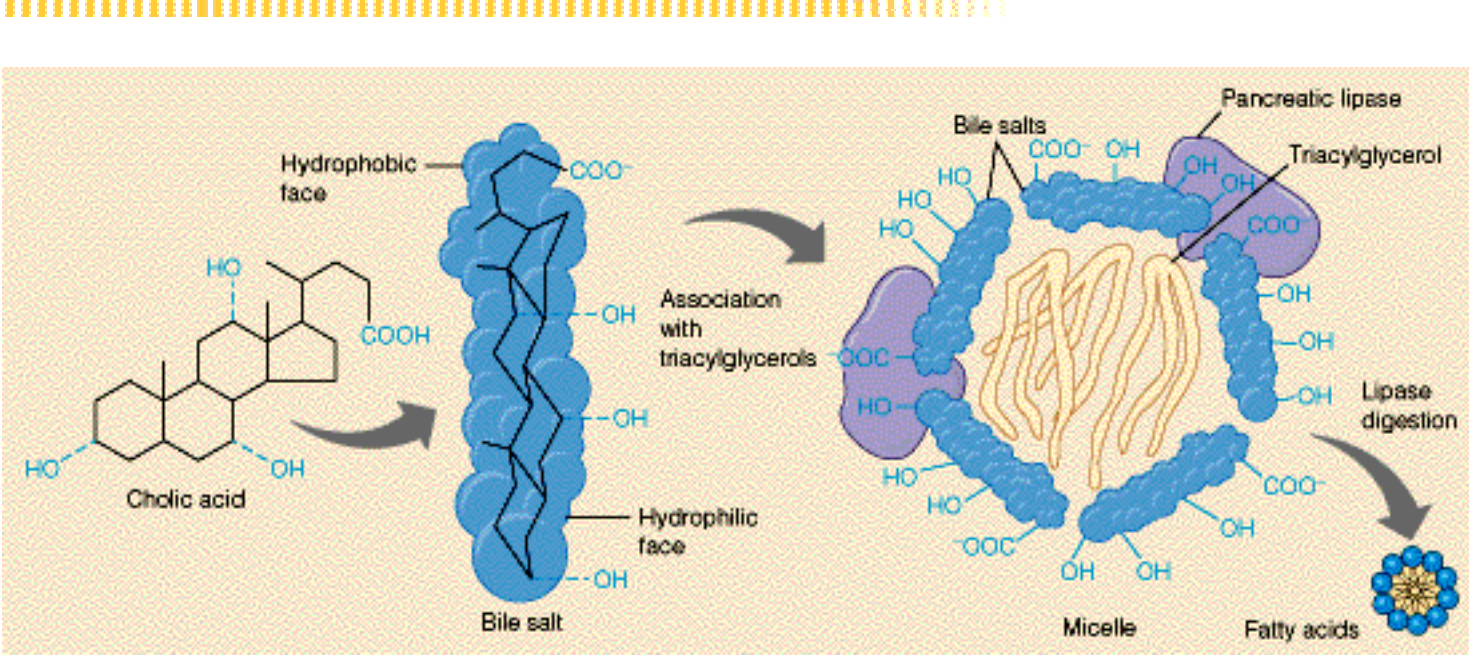

Cholic Acid (Cholate)

Cholic acid is one of the most abundant bile acids in humans. **Cholic acid** is usually conjugated in amide linkage with the amino acids glycine or taurine, yielding glycocholate and taurocholate, respectively.

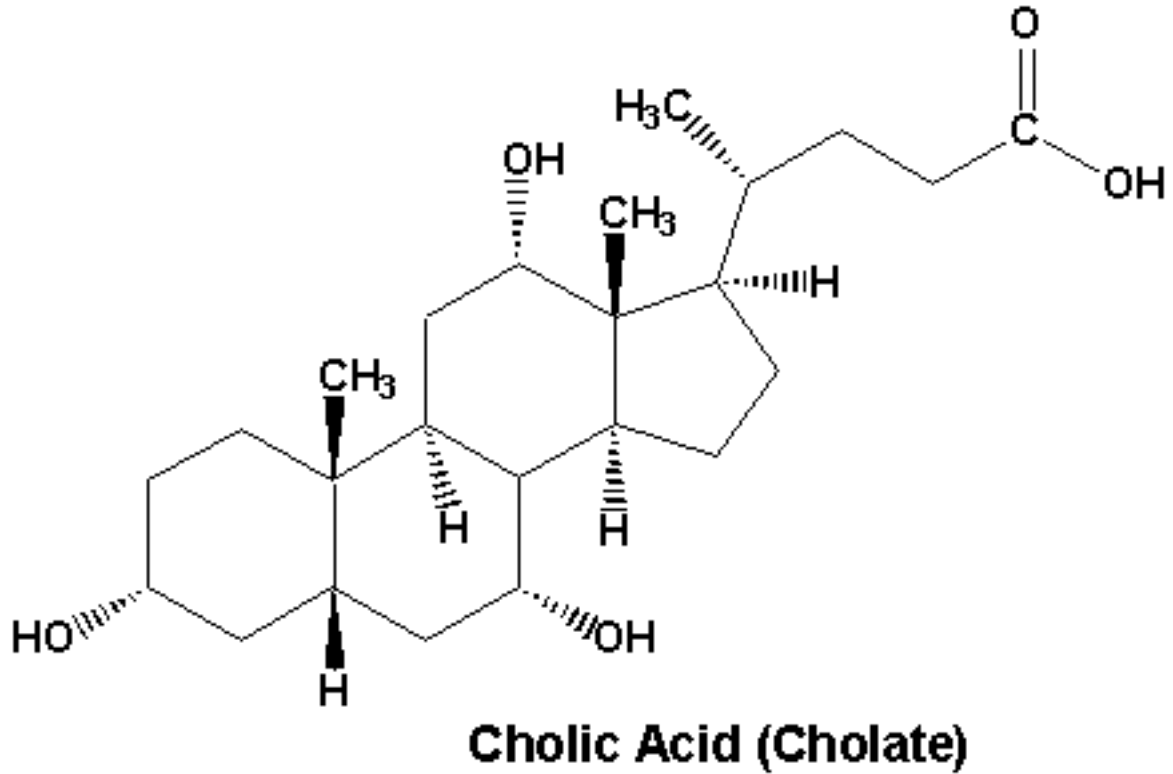

Bile salts play important roles in emulsification of fat in the digestion process ([Figure 18.4](#)).

See also: [Bile Acids](#), [Bile Salts](#), [Glycine](#), [Taurine](#), [Glycocholate](#), [Taurocholate](#), [Chenodeoxycholate](#), [Bile Salts and Emulsion of Fats](#)

INTERNET LINK: [Bile Acid Biosynthesis](#)

Bile Salts

Bile salts (made from bile acids) are secreted from the liver, stored in the gallbladder, and passed through the bile duct and into the intestine ([Figure 18.3](#)). They are involved in emulsification of fats in the intestine, aid digestion and absorption of fats and fat-soluble vitamins ([Figure 18.4](#)).

Bile acids are usually conjugated in amide linkage with the amino acid glycine or taurine, giving **bile salts**. The cholic acid conjugates with glycine and taurine are called glycocholate and taurocholate, respectively.

See also: [Figure 19.23](#), [Bile Salts and Emulsion of Fats](#), [Bile Acids](#) (from Chapter 19), [Fats](#), [Glycine](#), [Taurine](#), [Glycocholate](#), [Taurocholate](#), [Cholic Acid](#)

INTERNET LINK: [Bile Acid Biosynthesis](#)

Figure 19.23: Biosynthesis of bile acids and salts from cholesterol.

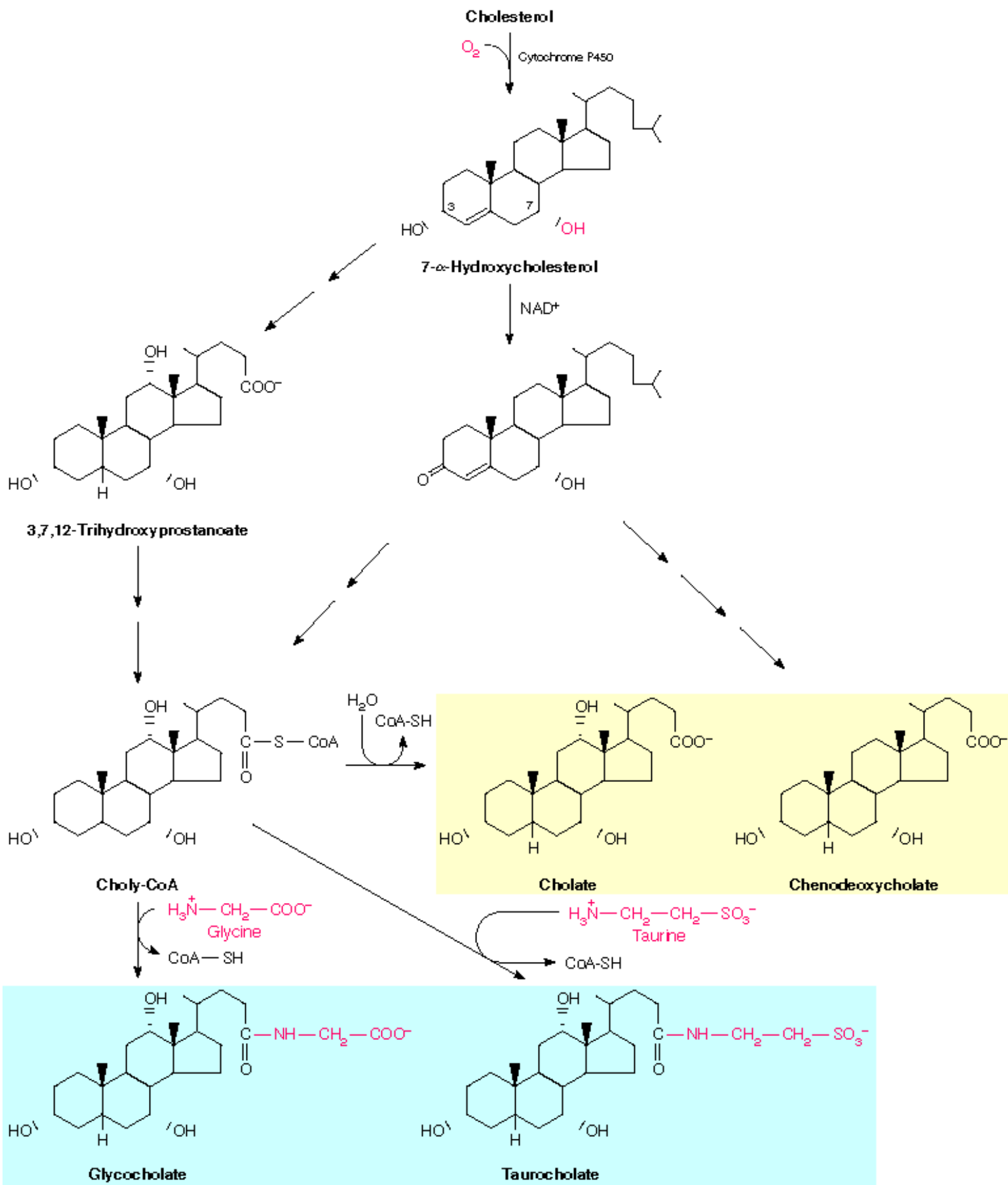

Bile Salts and Emulsion of Fats

Bile salts are detergent-like substances secreted from the gallbladder that aid in the digestion and absorption of lipids. A **bile salt** is made up of a bile acid and an associated cation, usually an amino acid. Examples include glycocholate and taurocholate.

Like a detergent, **bile salts** contain hydrophobic and hydrophilic components. The hydrophobic portions of the molecule associate with the fat, and the hydrophilic parts associate with water, serving to solubilize (emulsify) the otherwise insoluble fat. See [Figure 18.4](#).

See also: [Bile Salts](#), [Glycocholate](#), [Taurocholate](#), [Cholic Acid](#), [Bile Acids](#) (from Chapter 19)

INTERNET LINK: [Bile Acid Biosynthesis](#)

Glycocholate

Glycocholate is a bile salt formed as a result of conjugation of **cholic acid** with **glycine** via an amide linkage.

See also: , [Bile Salts](#), [Bile Salts and Emulsion of Fats](#)

INTERNET LINK: [Bile Acid Biosynthesis](#)

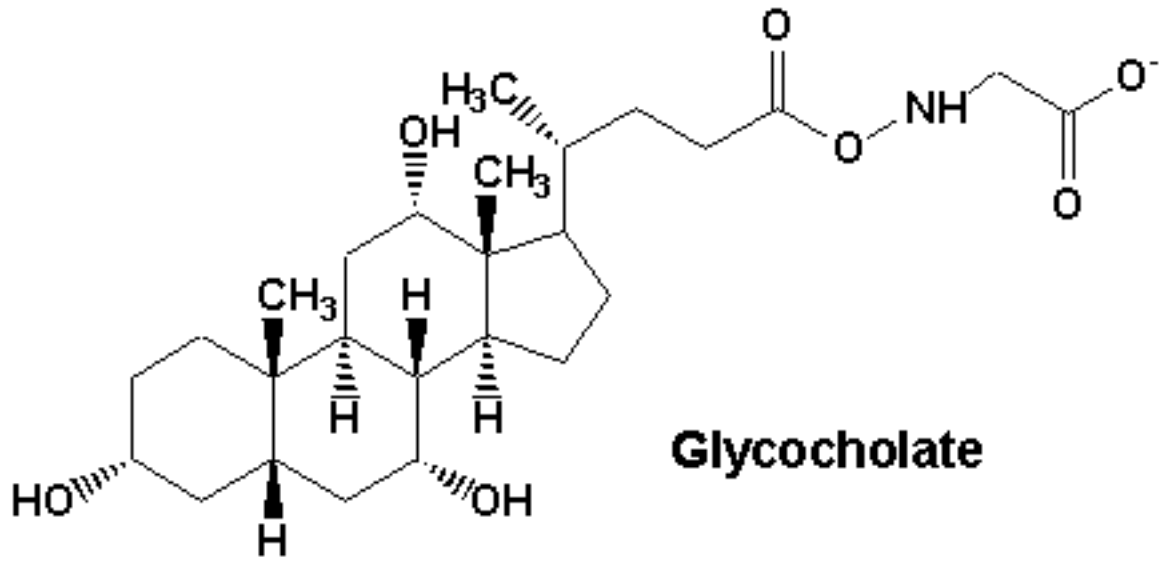

Taurocholate

Taurocholate is a **bile salts** formed as a result of conjugation of cholic acid with **taurine** via an amide linkage.

See also: [Cholic Acid](#), ,
[Bile Salts and Emulsion of Fats](#)

INTERNET LINK:
[Bile Acid Biosynthesis](#)

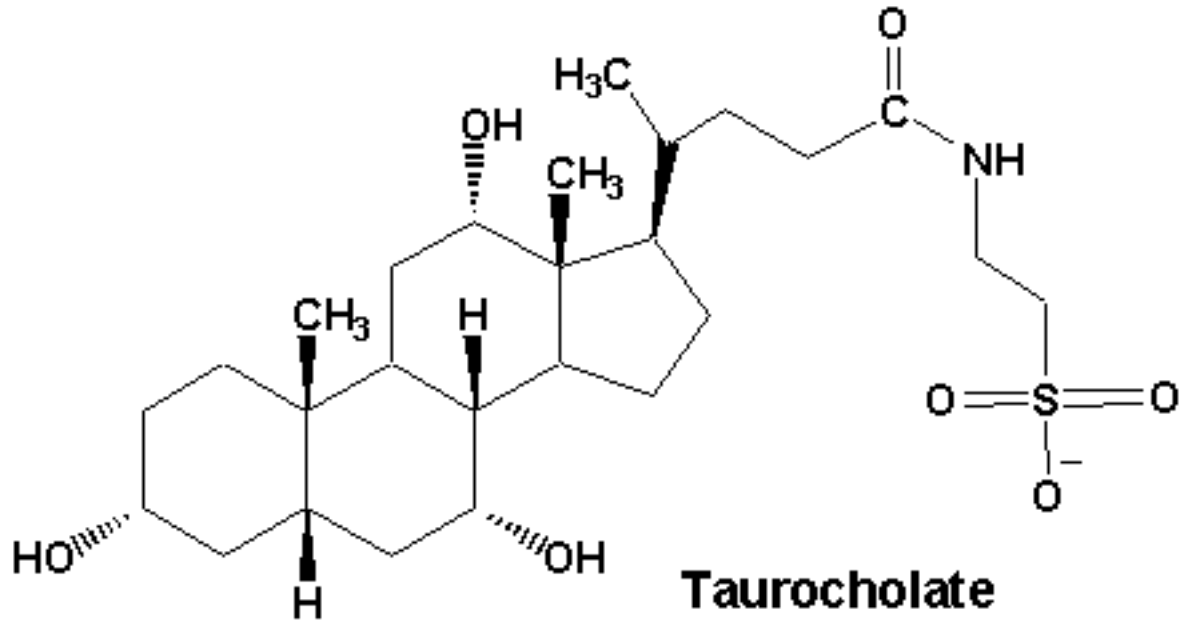

Taurine

Taurine is a by-product of cysteine metabolism. **Taurine** is conjugated to cholic acid to form taurocholate, a bile salt.

See also: Bile Salts and Emulsion of Fats

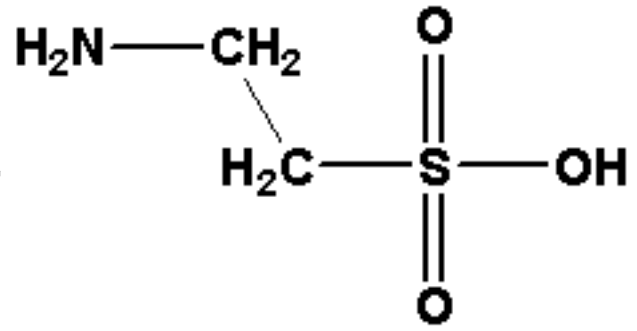

Taurine

Chenodeoxycholic Acid (Chenodeoxycholate)

The most abundant bile acids in humans are cholic acid and **chenodeoxycholic acid** ([Figure 19.23](#)). They are usually conjugated in amide linkage with the amino acid **glycine** or **taurine**. The cholic acid conjugates with glycine and taurine are called **glycocholate** and **taurocholate**, respectively.

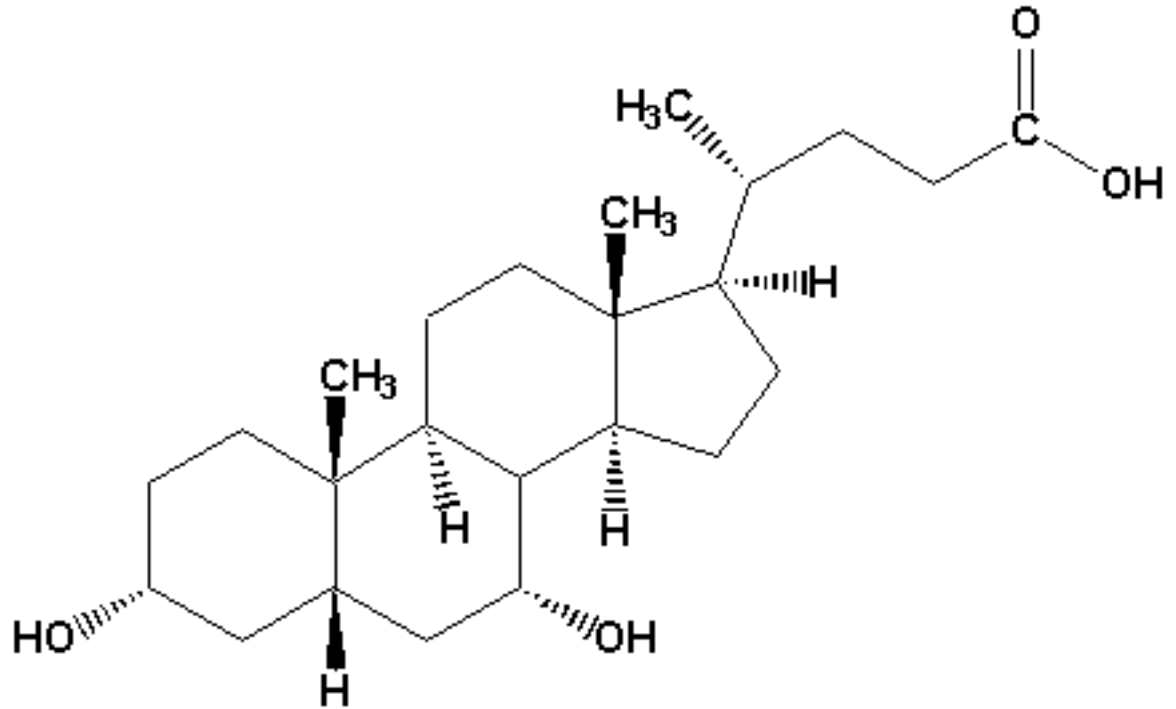

Chenodeoxycholic Acid (chenodeoxycholate)

Bile salts play important roles in emulsification of fat in the digestion process ([Figure 18.4](#)).

See also: [Bile Acids](#), [Bile Salts](#), [Glycine](#), [Taurine](#), [Glycocholate](#), [Taurocholate](#), [Cholic Acid](#), [Bile Salts and Emulsion of Fats](#)

INTERNET LINK: [Bile Acid Biosynthesis](#)

Cholesterol Biosynthesis

All 27 carbons from **cholesterol** can be traced to acetate, a two-carbon precursor.

Cholesterol biosynthesis springs from a six-carbon intermediate called mevalonate ([Figure 19.18](#)). Mevalonate arises, in turn, from linkage of two [acetyl-CoAs](#) in the mitochondrion to form [acetaoacetyl-CoA](#) (4 carbons), followed by addition of another acetyl group from a third acetyl-CoA to give [3-hydroxy-3-methylglutaryl-CoA](#) (HMG-CoA). This latter compound is reduced by HMG-CoA reductase in the endoplasmic reticulum, using two NADPHs, with coincident loss of CoASH.

[HMG-CoA reductase](#) is the major regulatory enzyme in cholesterol biosynthesis. HMG-CoA reductase is controlled hormonally by [insulin](#) and [glucagon](#) and transcription and translation of the enzyme can be suppressed by the presence of cholesterol in cells. [Mevalonate](#) is converted in the cytosol to the five carbon building blocks of isoprene synthesis-[isopentenyl pyrophosphate](#) (IPP) and [dimethylallyl pyrophosphate](#) (DPP)-in the reactions shown in [Figure 19.19](#). Subsequently, IPP and DPP form farnesyl pyrophosphate in the cytosol ([Figure 19.20](#))

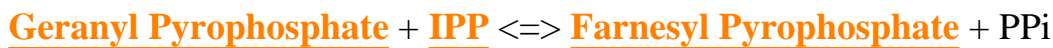

Farnesyl pyrophosphate is then converted to presqualene pyrophosphate in the membrane of the endoplasmic reticulum ([Figure 19.21](#)).



Presqualene pyrophosphate is subsequently converted to [squalene](#), also in the membrane of endoplasmic reticulum ([Figure 19.21](#)). Subsequent reactions occur in the [endoplasmic reticulum](#). Squalene, for example, is cyclized there to [lanosterol](#), which is subsequently converted to **cholesterol** ([Figure 19.22](#)).

See also: [Steroid Metabolism](#), [Steroid Hormone Synthesis](#), [Bile Acids](#)

INTERNET LINK: [Sterol Biosynthesis](#)

Isopentenyl Pyrophosphate

Isopentenyl pyrophosphate (IPP) is one of two five-carbon building blocks of the isoprenoids. Dimethylallyl pyrophosphate (DAP) is the other. **IPP** is synthesized from 3-phospho-5-pyrophosphomevalonate, as shown in [Figure 19.19](#). The first step in isoprenoid synthesis is as follows:

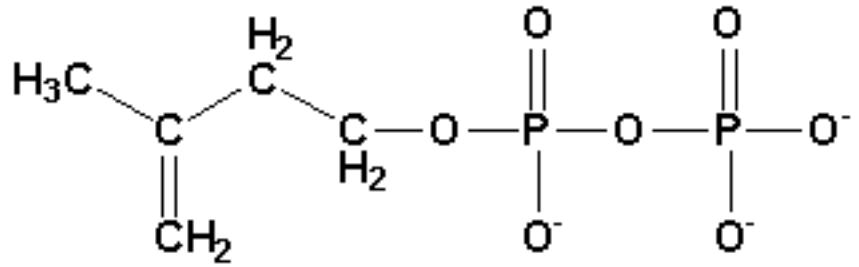

Isopentenyl Pyrophosphate



Subsequently, in cholesterol biosynthesis, another molecule of IPP reacts with geranyl pyrophosphate ([Figure 19.20](#)) to form farnesyl pyrophosphate, as follows:



See also: [Cholesterol Biosynthesis](#), [Steroid Metabolism](#), [Steroid Hormone Synthesis](#), [Bile Acids](#), [Lipid-Soluble Vitamins](#), [Plant Hormones](#)

INTERNET LINK: [Sterol Biosynthesis](#)

Dimethylallyl Pyrophosphate

Dimethylallyl pyrophosphate (DPP)

is one of two five-carbon building blocks of the isoprenoids. Isopentenyl pyrophosphate (IPP) is the other. **DPP** is synthesized from IPP, as shown in [Figure 19.19](#). The first step in isoprenoid synthesis is as follows:

[DPP](#) + [IPP](#) \rightleftharpoons [Geranyl Pyrophosphate](#) + PPi ([Figure 19.20](#))

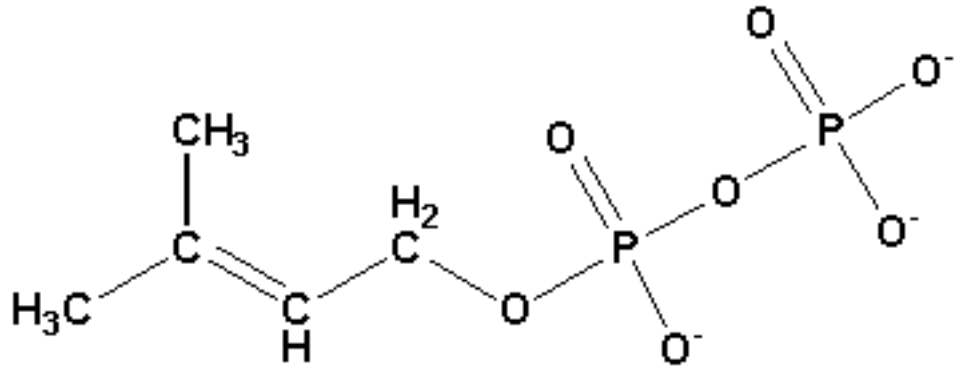

Dimethylallyl Pyrophosphate

See also: [Cholesterol Biosynthesis](#), [Steroid Metabolism](#), [Steroid Hormone Synthesis](#), [Bile Acids](#), [Lipid-Soluble Vitamins](#), [Figure 19.28](#)

INTERNET LINK: [Sterol Biosynthesis](#)

Geranyl Pyrophosphate

Geranyl pyrophosphate is an intermediate in isoprenoid biosynthesis formed by joining dimethylallyl pyrophosphate (DPP) with isopentenyl pyrophosphate (IPP), as follows:

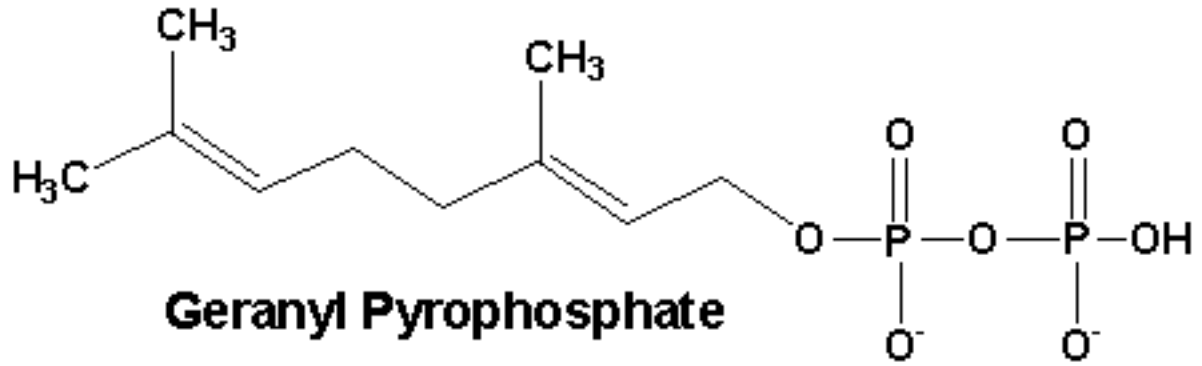

In cholesterol biosynthesis, **geranyl pyrophosphate** is converted to farnesyl pyrophosphate, as follows:



See also: [Cholesterol Biosynthesis](#), [Steroid Metabolism](#), [Steroid Hormone Synthesis](#)

INTERNET LINK: [Sterol Biosynthesis](#)

Figure 19.20: Conversion of isopentenyl pyrophosphate and dimethylallyl pyrophosphate to farnesyl pyrophosphate.

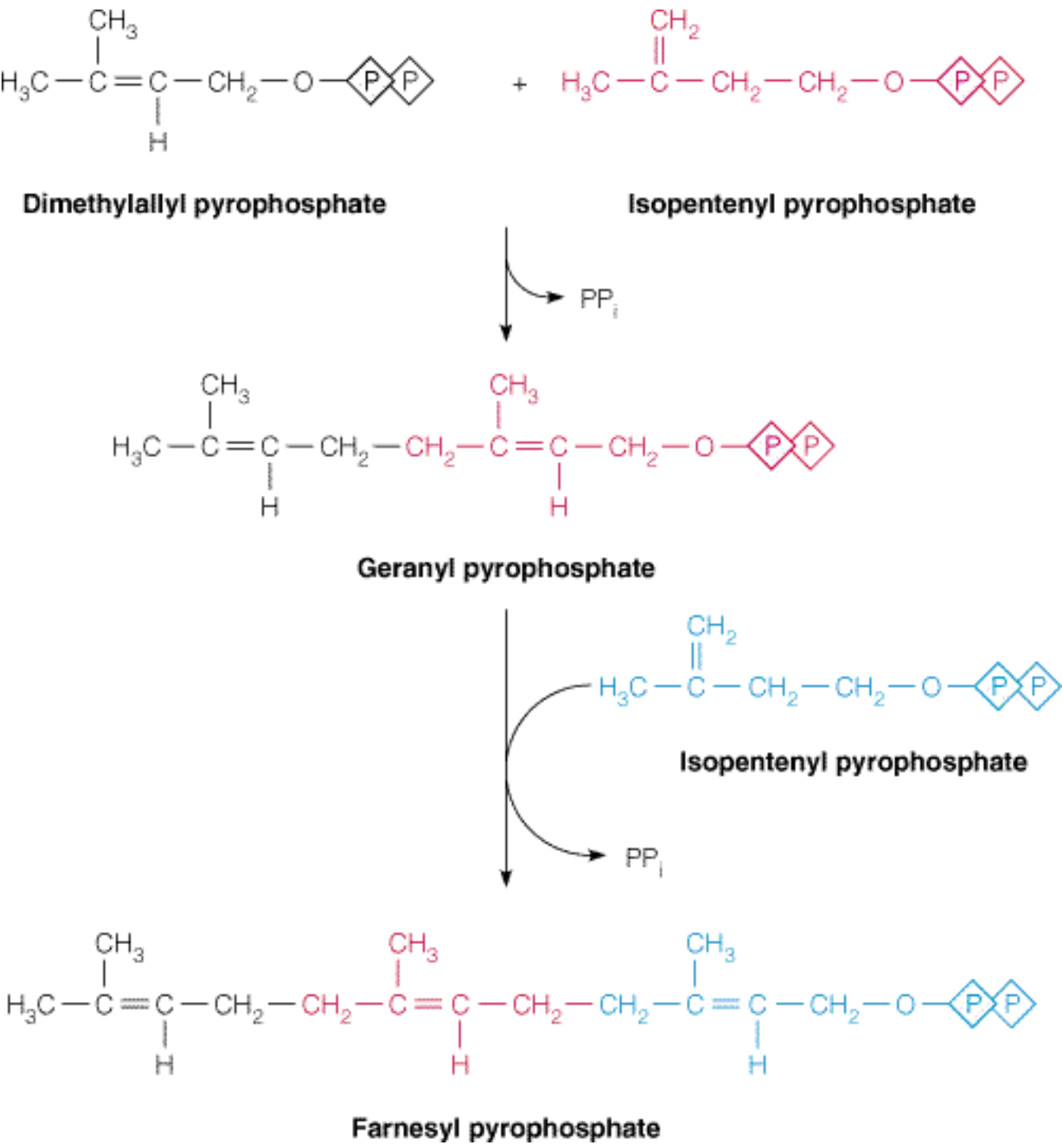

Farnesyl Pyrophosphate

Farnesyl pyrophosphate is an intermediate in isoprenoid biosynthesis formed by joining geranyl pyrophosphate with isopentenyl pyrophosphate (IPP), as follows:

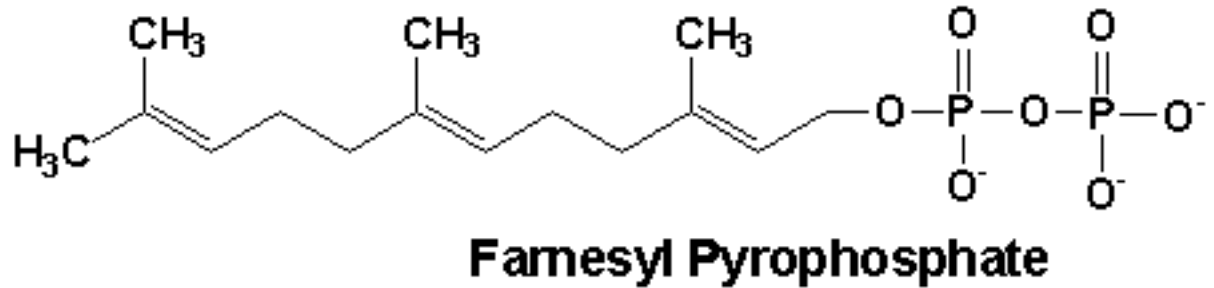

Geranyl Pyrophosphate + **IPP** \rightleftharpoons **Farnesyl Pyrophosphate** + **PPi** (**Figure 19.20**)

In cholesterol biosynthesis, farnesyl pyrophosphate is converted to presqualene pyrophosphate, as follows:

2 Farnesyl Pyrophosphate \rightleftharpoons **Presqualene Pyrophosphate** + **PPi** (**Figure 19.21**)

See also: **Cholesterol Biosynthesis**, **Steroid Metabolism**, **Steroid Hormone Synthesis**, **Bile Acids**

INTERNET LINK: **Sterol Biosynthesis**

Presqualene Pyrophosphate

Presqualene pyrophosphate is an intermediate in cholesterol and steroid biosynthesis ([Figure 19.21](#)). It is made in the membrane of the endoplasmic reticulum by joining two farnesyl pyrophosphates in the reaction that follows:

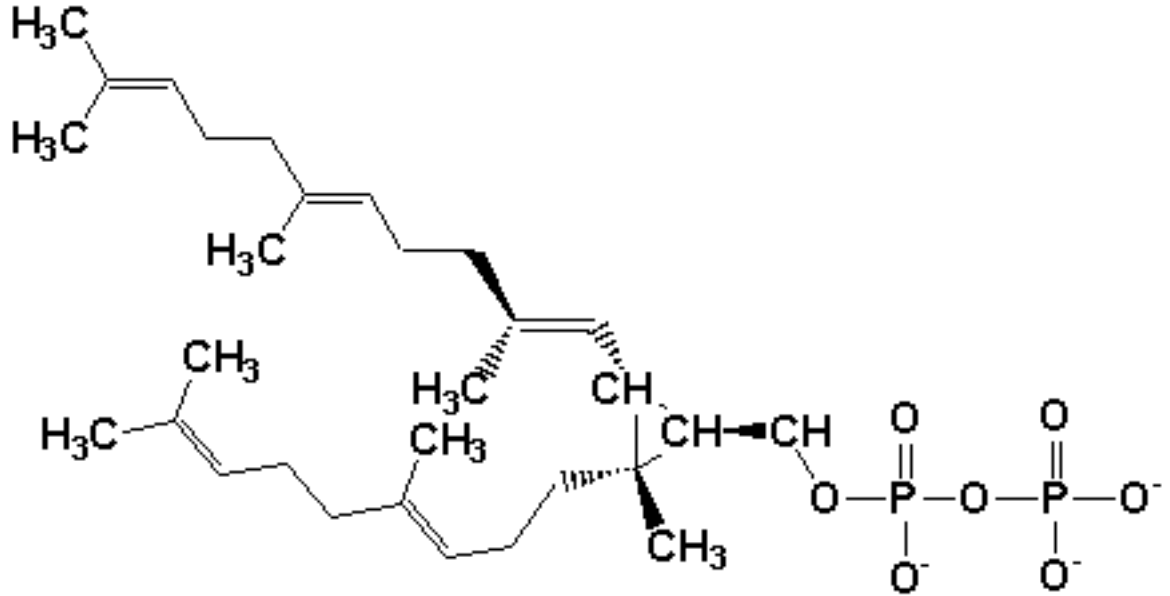

2 [Farnesyl Pyrophosphate](#) \rightleftharpoons [Presqualene Pyrophosphate](#)

Presqualene Pyrophosphate

Presqualene pyrophosphate is subsequently converted to [squalene](#), also in the membrane of the endoplasmic reticulum ([Figure 19.21](#)).

See also: [Cholesterol Biosynthesis](#), [Steroid Metabolism](#), [Steroid Hormone Synthesis](#), [Bile Acids](#)

INTERNET LINK: [Sterol Biosynthesis](#)

Figure 19.21: Conversion of farnesyl pyrophosphate to squalene.

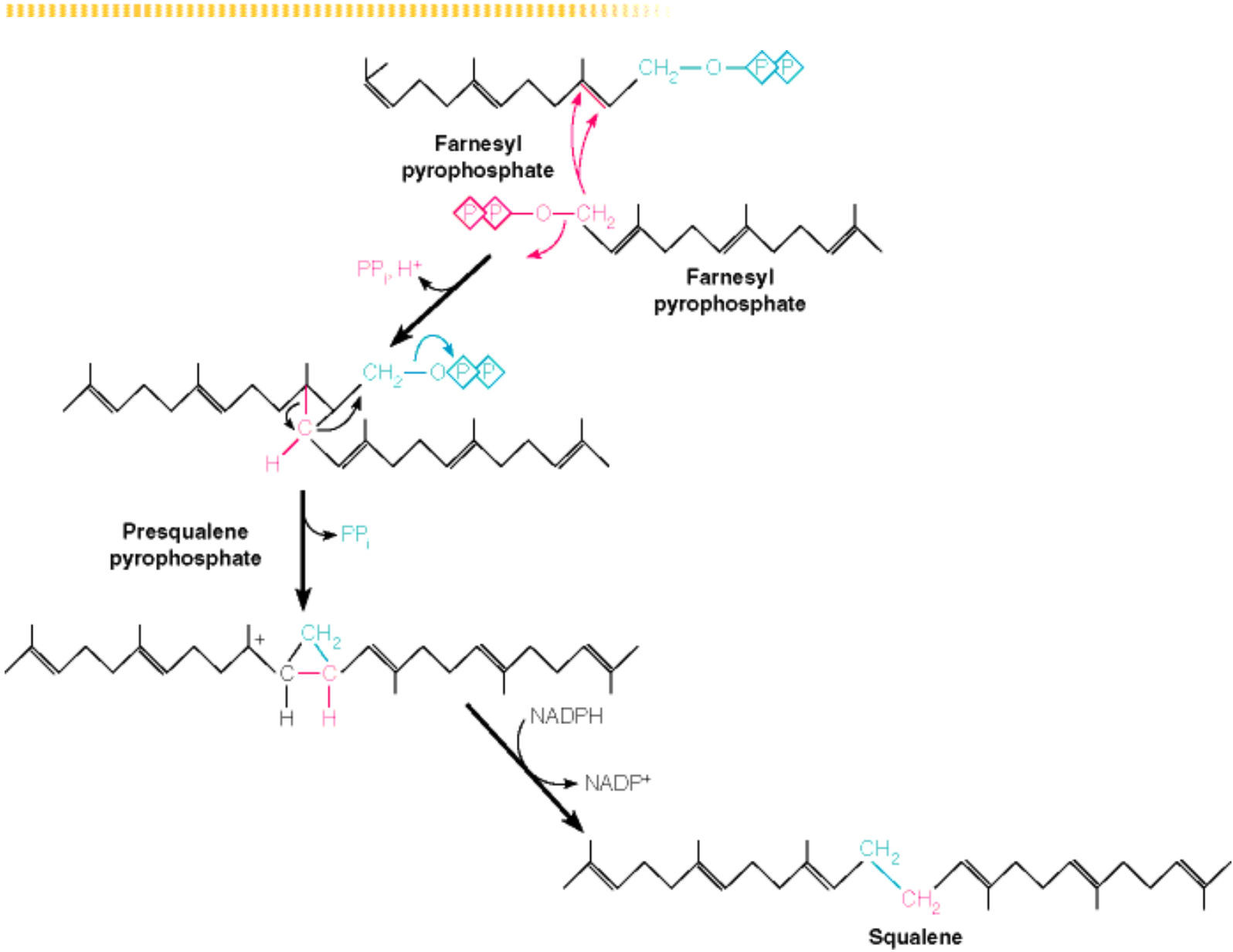

Squalene

Squalene is an intermediate in cholesterol and steroid biosynthesis. It is formed from presqualene pyrophosphate ([Figure 19.21](#)) in the walls of the endoplasmic reticulum using electrons from NADPH. In the reaction, the pyrophosphate is removed from the molecule.

Subsequently, **squalene** is cyclized to [lanosterol](#), which is subsequently converted to **cholesterol** ([Figure 19.22](#)).

See also: [Presqualene Pyrophosphate](#), [Lanosterol](#), [Cholesterol Biosynthesis](#), [Steroid Metabolism](#), [Steroid Hormone Synthesis](#)

INTERNET LINK: [Sterol Biosynthesis](#)

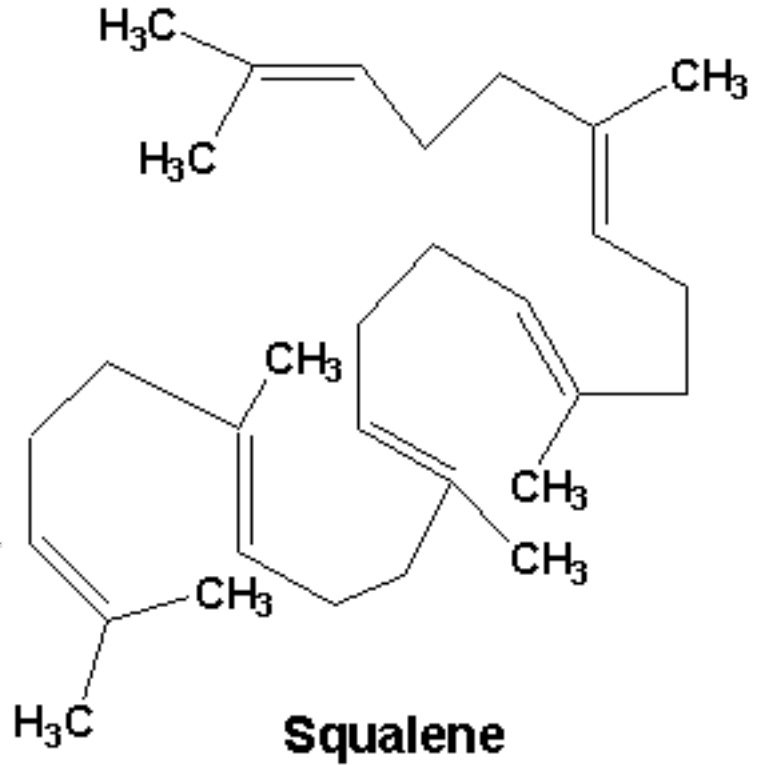

Lanosterol

Lanosterol is an intermediate in cholesterol biosynthesis.

Lanosterol is formed from squalene via squalene 2,3-epoxide, as shown in [Figure 19.22](#).

See also: [Cholesterol Biosynthesis](#), [Steroid Metabolism](#), [Steroid Hormone Synthesis](#), [Squalene](#)

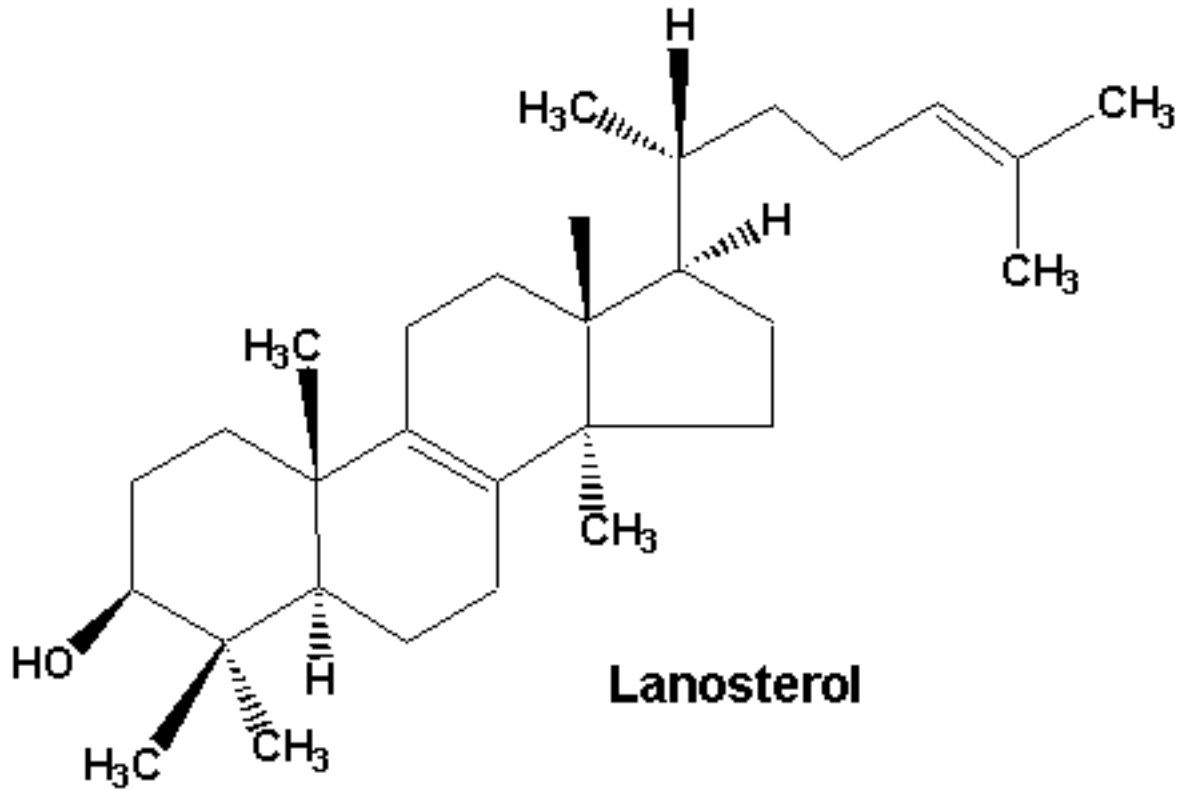

INTERNET LINK: [Sterol Biosynthesis](#)

Figure 19.22: Conversion of squalene to cholesterol.

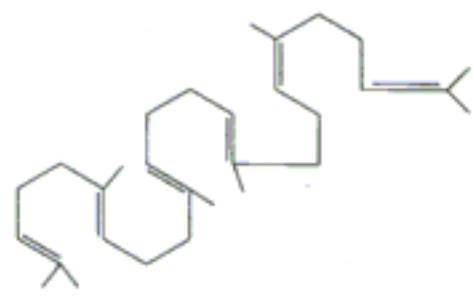

Squalene

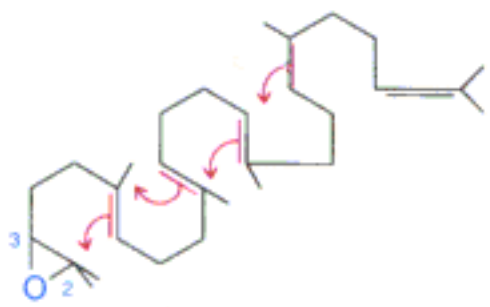
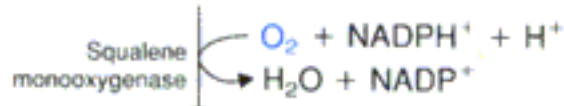

Squalene 2,3-epoxide

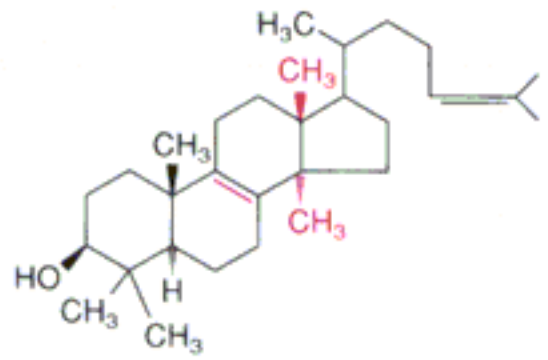
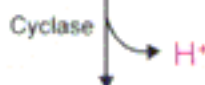
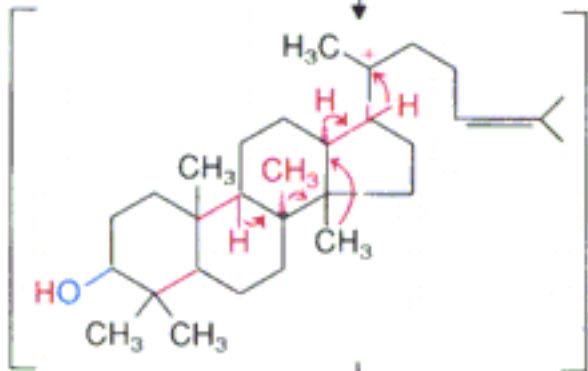

Lanosterol

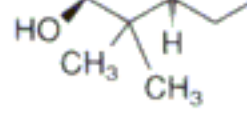

Lanosterol

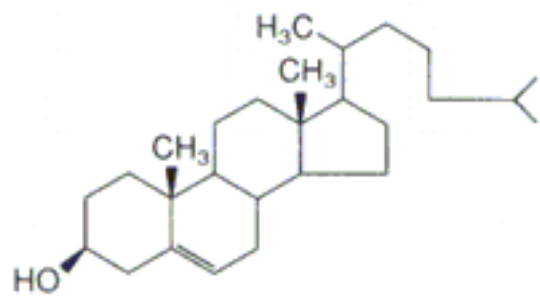
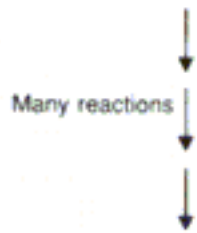

Cholesterol

Steroid Hormone Synthesis

Steroid hormones are extracellular messengers elaborated by the gonads and the adrenal cortex, plus the placenta in pregnant females. A general feature of **steroid hormones** is that they are not stored for release after synthesis. Levels of circulating hormones are controlled primarily by their rates of synthesis. This, in turn, is often controlled by signals from the brain.

Steroid hormones are classified into five major categories - progestins, mineralocorticoids, glucocorticoids, androgens, and estrogens.

Pregnenolone is derived from cholesterol and is the precursor of all other **steroid hormones**. For example, pregnenolone is converted to progesterone by oxidation of the hydroxyl group to a ketone and isomerization of a double bond (see here). Synthesis of other **steroid hormones** from progesterone is shown in Figure 19.24.

Note that 17-Hydroxyprogesterone is a branch point between synthesis of the glucocorticoids and the androgens. Thus, deficiency of 17-hydroxylase, the enzyme responsible for catalyzing the synthesis of 17-hydroxyprogesterone, leads to reduced amounts of cortisol (glucocorticoid), androgens, and estrogens.

Note also that the estrogens (e.g., estradiol) are derived from the androgens by aromatization of a ring. This reaction is catalyzed by an enzyme complex called aromatase. Reactions catalyzed by aromatase represent the only known route for synthesis of aromatic rings in animal cells.

Deficiency of 21-hydroxylase inhibits the synthesis of glucocorticoids (e.g., cortisol) and mineralocorticoids (e.g., aldosterone), leading to overproduction of testosterone in the adrenal glands and underproduction of cortisol. The latter effectively increases adrenocorticotropic hormone (ACTH), which stimulates the adrenals to grow and synthesize steroids, exacerbating the testosterone overproduction. This leads to masculinization of females.

Deficiency of 5 α -reductase, the enzyme that converts testosterone to dihydrotestosterone, decreases effective androgen levels and leads to feminization of males.

Synthetic steroid hormones include the following:

Diethylstilbestrol, a synthetic estrogen previously used to promote growth of beef cattle, until it was found to be potentially carcinogenic at the levels found in meat from treated cattle.

Oral contraceptives, such as [norethynodrel](#) and [mestranol](#).

Mammalian cells lack the ability to completely degrade steroid compounds. As a result, most become conjugated through their hydroxyl groups to [glucuronate](#) or sulfate and are eliminated in the urine. This is why the urine of athletes is used to test for illegal steroid hormone use.

See also: [Steroid Metabolism](#), [Steroid Hormones](#), [Cholesterol Biosynthesis](#), [Cholesterol](#)

INTERNET LINKS:

1. [Steroid Hormone Metabolism](#)
 2. [Androgen and Estrogen Metabolism](#)
-

Mineralocorticoids

Mineralocorticoids are a class of [steroid hormones](#) that includes the hormone [aldosterone](#) ([Figure 19.24](#)). **Mineralocorticoids** regulate ion balance by promoting reabsorption of sodium, chloride, and bicarbonate in the kidney.

See also: [Steroid Metabolism](#), [Steroid Hormone Synthesis](#), [Figure 23.8](#)

INTERNET LINKS:

1. [Steroid Hormone Metabolism](#)
 2. [Androgen and Estrogen Metabolism](#)
-

Aldosterone

Aldosterone is a steroid hormone classified as a mineralocorticoid ([Figure 19.24](#)).

Aldosterone is derived from corticosterone via a dehydrogenation reaction. **Aldosterone** is synthesized in the adrenal cortex under stimulation from corticotropin ([Figure 23.8](#)).

See also: [Steroid Hormone Synthesis](#), [Steroid Hormones](#), [Steroid Metabolism](#), [Mineralocorticoids](#)

INTERNET LINK: [Steroid Hormone Metabolism](#)

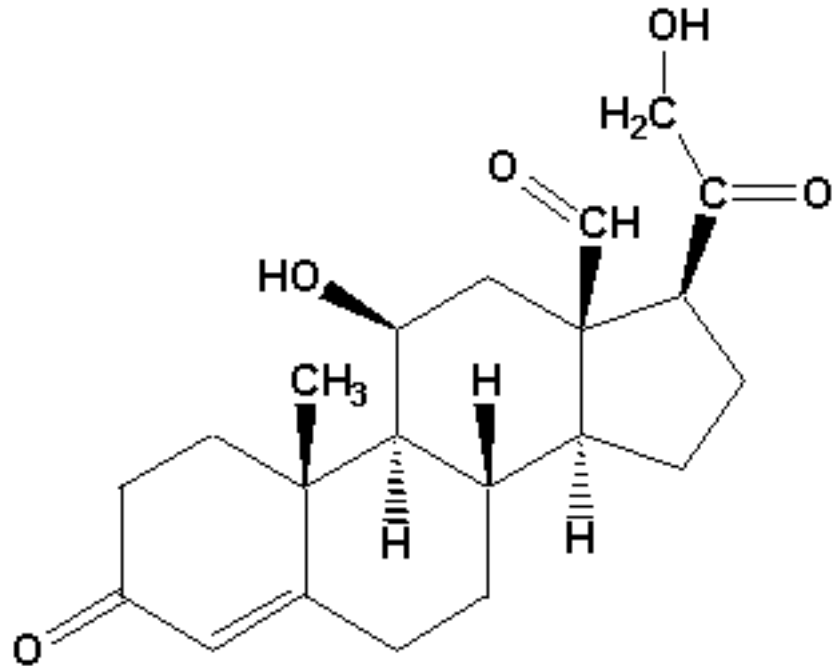

Aldosterone

Figure 23.8: Hierarchical nature of hormone action in vertebrates.

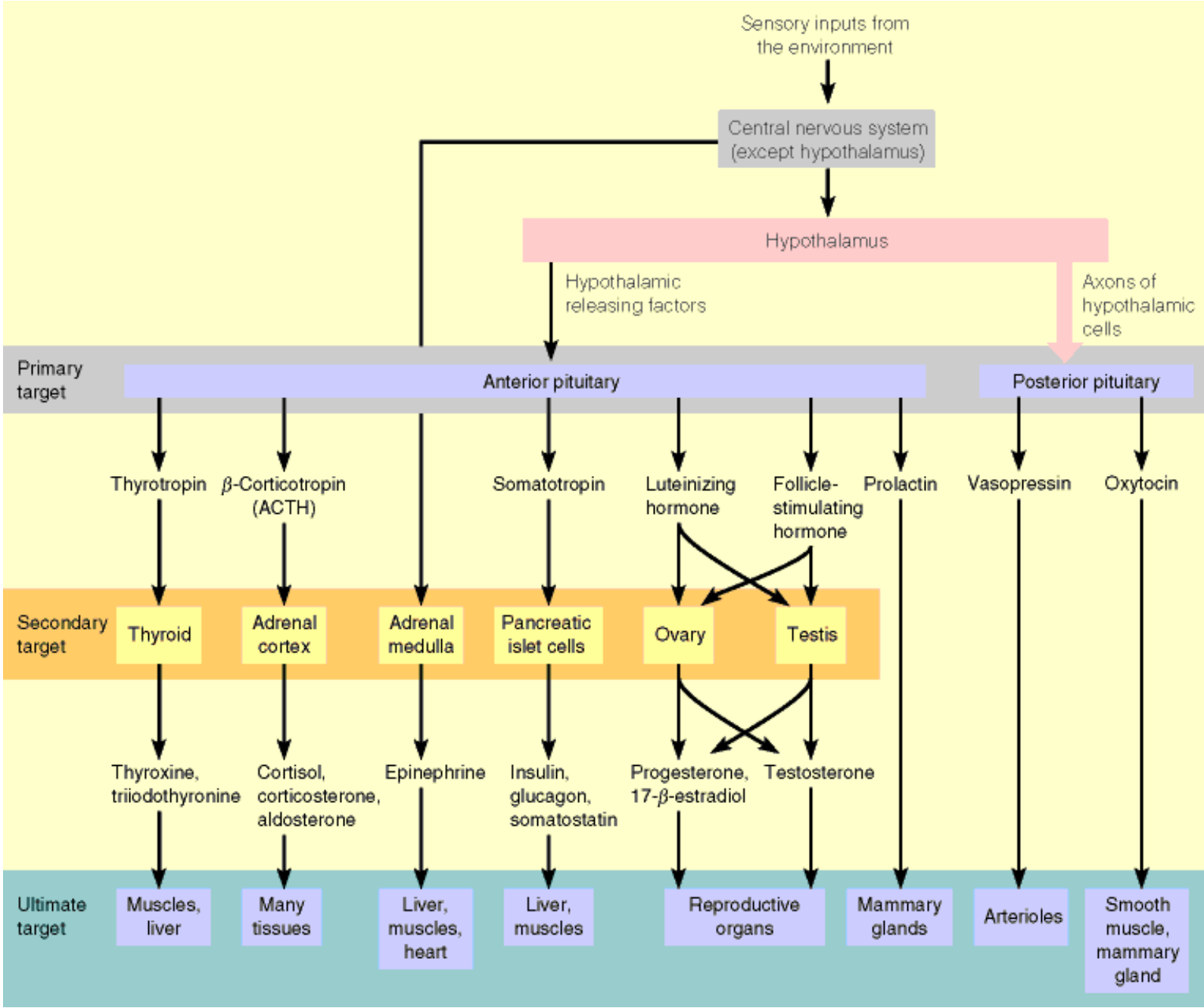

Glucocorticoid Hormones

Glucocorticoid hormones promote [gluconeogenesis](#) and, in pharmacological doses, suppresses inflammation reactions. β -corticotropin is secreted from the anterior pituitary, and it stimulates the adrenal cortex to produce **glucocorticoids** and mineralocorticoids, which in turn act on a number of tissues.

See also: [Figure 19.24](#), [Cortisol](#), [Figure 23.8](#), [Steroid Metabolism](#), [Steroid Hormone Synthesis](#), [Steroid Hormones](#), [Mineralocorticoids](#), [Steroid and Thyroid Hormones - Intracellular Receptors](#)

INTERNET LINKS:

1. [Steroid Hormone Metabolism](#)
 2. [Androgen and Estrogen Metabolism](#)
-

Cortisol

Cortisol is a glucocorticoid hormone secreted by the adrenal cortex ([Figure 23.8](#)). Glucocorticoid hormones promote gluconeogenesis and, in pharmacological doses, suppresses inflammation reactions.

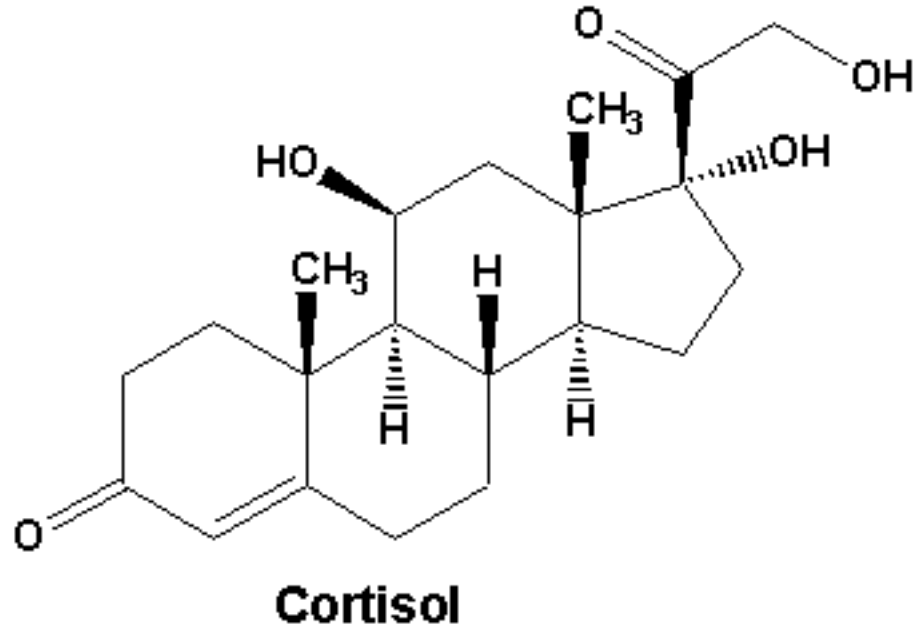

See also: [Figure 19.24](#), [Glucocorticoid Hormones](#), [Steroid Hormone Synthesis](#), [Steroid Hormones](#), [Steroid Metabolism](#), [Gluconeogenesis](#)

INTERNET LINK: [Steroid Hormone Metabolism](#)

Steroid and Thyroid Hormones--Intracellular Receptors

Hormonal effects occurring via membrane receptors tend to be of short duration because they represent responses to rapid and urgent physiological demands and involve activation or inhibition of preexisting enzymes.

The effects of **steroids** involve longer-term changes, such as the conversion of a resting cell to a growing cell. **Steroids** and related hormones (i.e., thyroid, vitamin D, and retinoic acid hormones) act intracellularly, within the nucleus, where they regulate transcription of specific genes (usually positively). **Table 23.6** lists several proteins whose synthesis is affected by these hormones.

Steroid and related hormones bind to specific receptor proteins in the cytosol. The receptor-hormone complexes dimerize and move into the nucleus, where they interact with specific DNA sequences called hormone-responsive elements (HREs).

cDNA sequence analysis of intracellular hormone receptors has revealed structural similarities among steroid receptors. Unambiguous identification of domains of function within the receptor molecule has also been performed. All of the known receptors in this family contain bound zinc, which is essential for DNA binding. Furthermore, the DNA-binding sequences show a completely conserved distribution of **cysteine** residues (**Figure 23.16**). Zinc atoms are probably complexed by the cysteine sulfurs in a pattern akin to the "zinc finger" structural motif of other eukaryotic transcriptional regulatory proteins (**Figure 28.23**, **Figure 23.17**).

The utility of a set of long-term-acting regulators is evident the **estrogens** and **progesterone** that regulate the female reproductive cycle. In humans these hormones interact over a 4-week cycle to prepare the uterus for implantation of a fertilized ovum.

The actions of **glucocorticoids** are comparable, in that control of the synthesis of particular proteins allows for long-term metabolic adaptation. Whereas estrogens exercise control of reproductive metabolism over a several-week period, the secretion of glucocorticoids is a means of adaptation to longer-term stress. This adaptation involves stimulation of **gluconeogenesis** and synthesis of a variety of proteins, including some that counteract the effects of inflammation. Unlike estrogens, which act chiefly in reproductive tissues, the glucocorticoids influence cells in a wide variety of target tissues. Glucocorticoids act to stimulate transcription of a protein called $\text{I}\kappa\text{B}\alpha$, which inactivates the transcriptional factor called NF- κB . NF- κB helps control transcription of the cytokines, which stimulate the immune response (**Figure 23.18**).

The growth of some breast tumor cells is activated by estrogen. The drug, **tamoxifen** binds to estrogen receptors without activating estrogen-responsive genes. Tamoxifen treatment of patients with such tumors after surgery or chemotherapy often antagonizes estrogen binding in residual tumor cells and

retards their growth. The drug, [RU486](#), binds to progesterone receptors and blocks the events essential to implantation of a fertilized ovum in the uterus. Hence, RU486 is an effective contraceptive agent, even when taken after intercourse.

See also: [Hormone Receptors](#), [Steroid Hormones](#)

INTERNET LINK:

1. [C2H2 Zinc Finger Proteins](#)
 2. [Zinc Finger-Like Domains](#)
-

Table 23.6

Hormone Class	Target Organ	Protein ^a
Glucocorticoids	Liver	Tyrosine aminotransferase
		Tryptophan oxygenase
		α -Fetoprotein (\downarrow)
		Metallothionein
	Liver, retina	Glutamine synthetase
Estrogens	Kidney	Phosphoenolpyruvate carboxykinase
	Oviduct	Ovalbumin
	Pituitary	Pro-opiomelanocortin
	Liver	Ovalbumin
		Vitellogenin
Progesterone	Oviduct	Lysozyme
		apo-VLDL
	Uterus	Uteroglobulin
Androgens	Prostate	Aldolase
	Kidney	β -Glucuronidase
	Oviduct	Albumin
1,25-Dihydroxyvitamin D ₃	Intestine	Calcium-binding protein
Thyroid hormones	Liver	Carbamoyl phosphate synthetase
		Malic enzyme
	Pituitary	Growth hormone
Ecdysone (in insects)	Epidermis	Prolactin (\downarrow)
		Dopa decarboxylase
	Fat body ^b	Vitellogenin

^aSynthesis of each indicated protein is increased by the hormone, except for the two identified by (\downarrow).

^bThe fat body is an organ in insects that plays some of the same roles as liver and adipose tissue.

Figure 23.16: The conserved DNA-binding domain in steroid receptors.

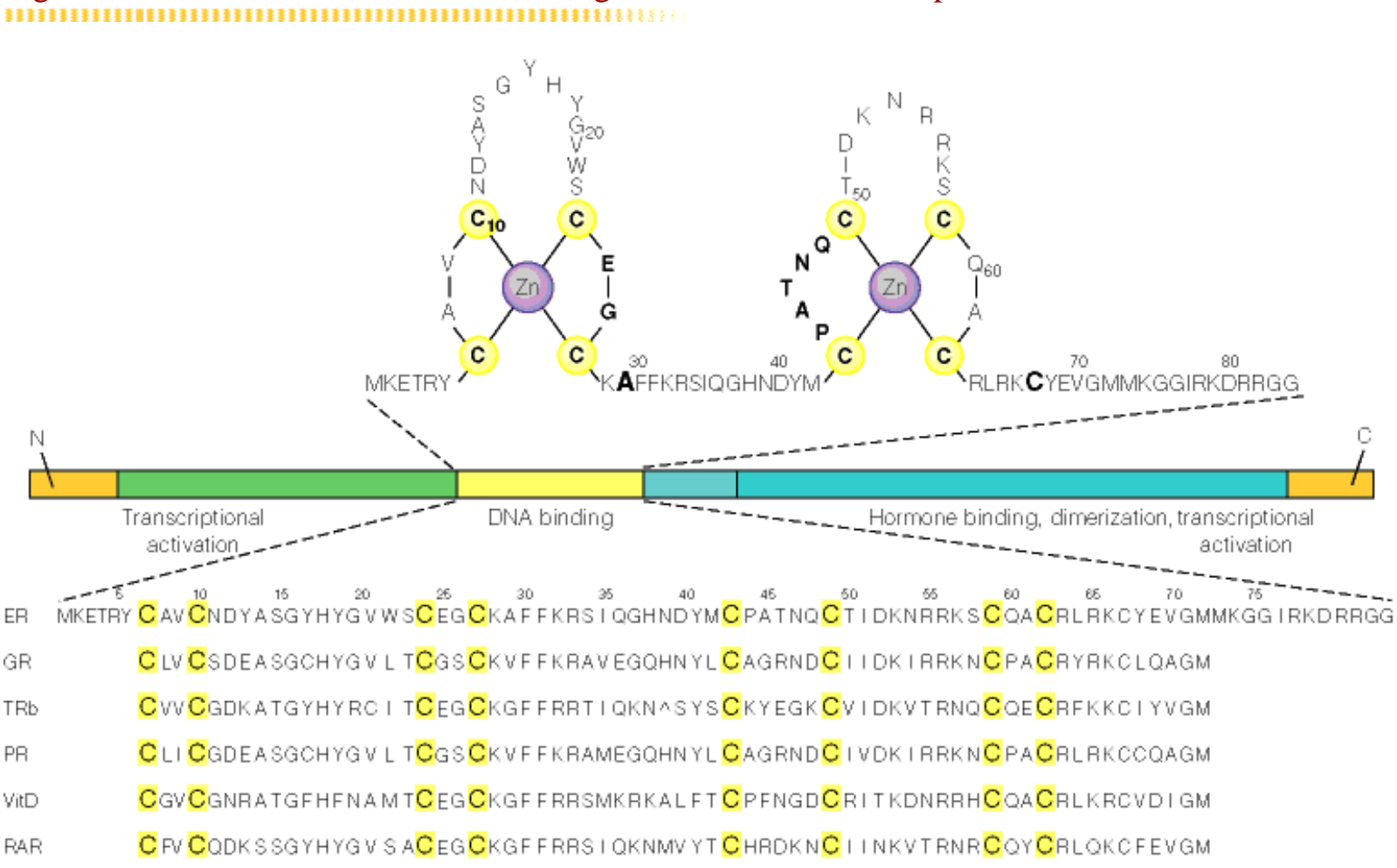

J. W. R. Schwabe and D. Rhodes, Trends Biochem. Sci. (1991) 16:292. © 1991 with permission of Elsevier Science.

Figure 23.17: Binding of the estrogen receptor to DNA, as inferred from solution NMR spectroscopy.

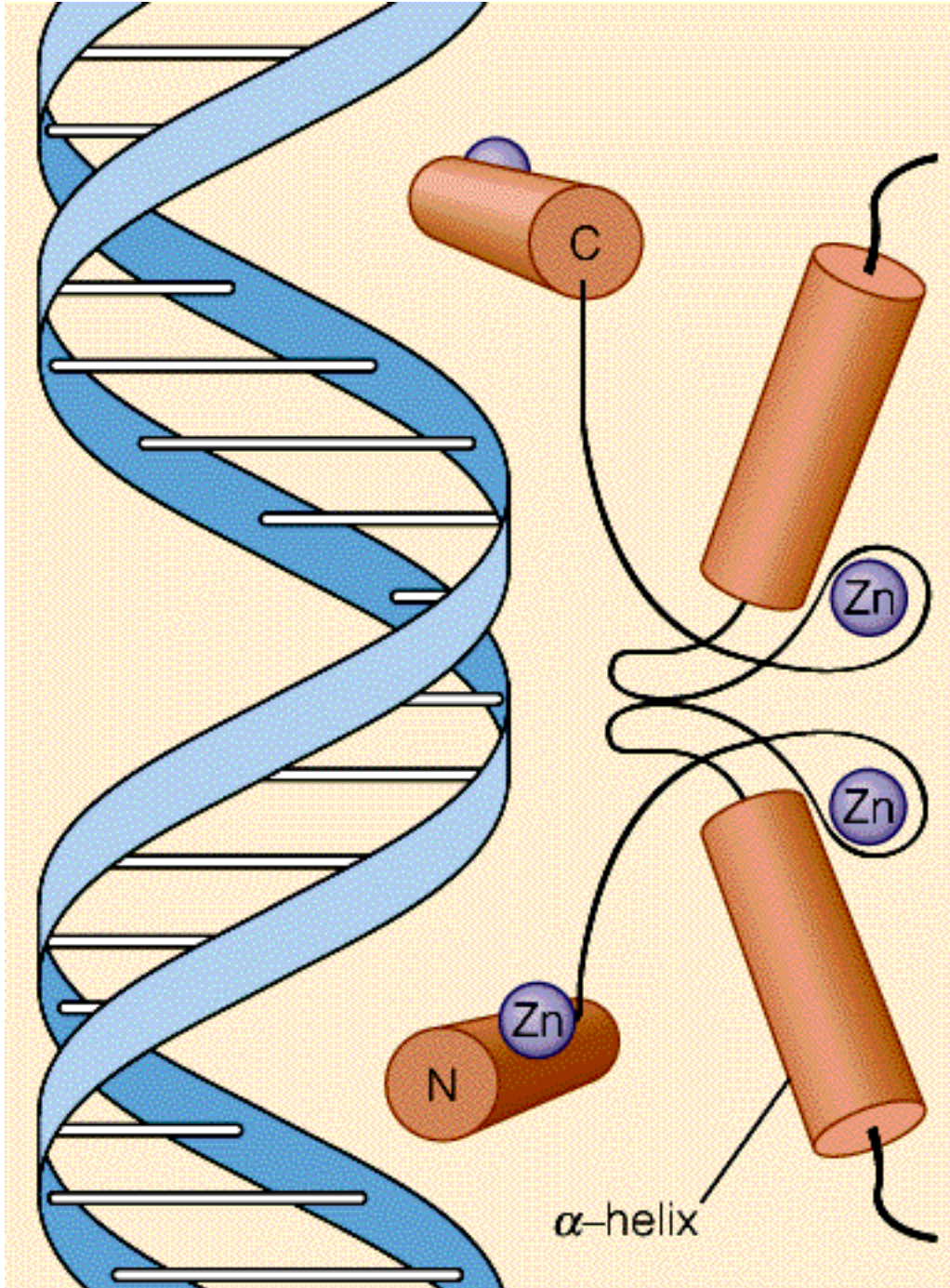

J. W. R. Schwabe and D. Rhodes, Trends Biochem. Sci. (1991) 16:292.

Estrogens

Estrogens are a class of female sex hormones that include estrone and estradiol. As shown in [Figure 19.24](#), estrogens are derived from the androgens (male sex hormones) by action of the enzyme aromatase.

See also: [Steroid Metabolism](#), [Steroid Hormone Synthesis](#), [Steroid Hormones](#), [Estradiol](#), [Androgens](#), [Steroid and Thyroid Hormones - Intracellular Receptors](#), [Tamoxifen](#)

INTERNET LINKS:

1. [Steroid Hormone Metabolism](#)
 2. [Androgen and Estrogen Metabolism](#)
-

Estradiol

Estradiol is a an estrogen hormone, which supports female sexual characteristics. As shown in [Figure 19.24](#), **estradiol** is derived from the male sex hormone, androstenedione by action of the enzyme aromatase.

See also: [Estrogens](#), [Steroid Hormone Synthesis](#), [Steroid Metabolism](#), [Steroid Hormones](#)

INTERNET LINKS:

1. [Steroid Hormone Metabolism](#)
 2. [Androgen and Estrogen Metabolism](#)
-

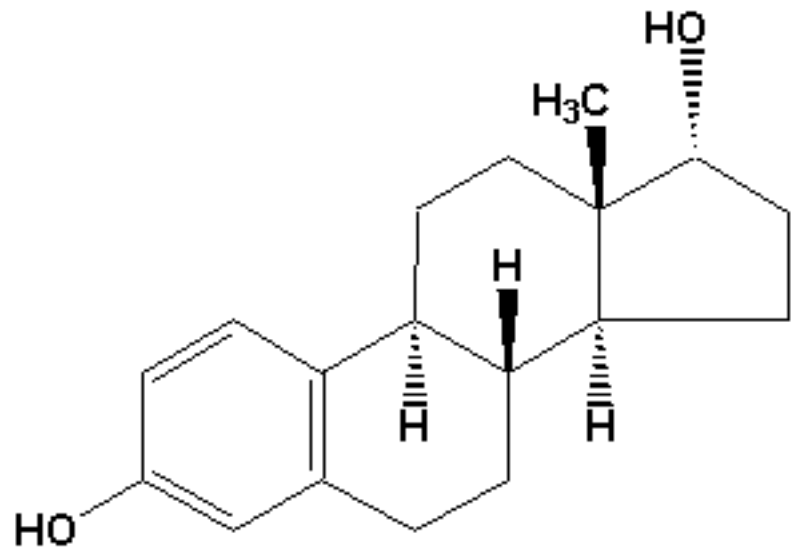

Estradiol(alpha)

Androgens

Androgens are a class of steroid hormones that include the male sex hormones [androstenedione](#), [testosterone](#), and dihydrotestosterone ([Figure 19.24](#)). The androgens are the precursors of the female sex hormones, the estrogens.

See also: [Steroid Metabolism](#), [Steroid Hormone Synthesis](#), [Steroid Hormones](#), [Testosterone](#), [Estrogens](#)

INTERNET LINKS:

1. [Steroid Hormone Metabolism](#)
 2. [Androgen and Estrogen Metabolism](#)
-

Androstenedione

Androstenedione is an androgen sex hormone.

See also: [Steroid Metabolism](#), [Steroid Hormone Synthesis](#), [Steroid Hormones](#), [Testosterone](#), [Estrogens](#)

INTERNET LINKS:

1. [Steroid Hormone Metabolism](#)
 2. [Androgen and Estrogen Metabolism](#)
-

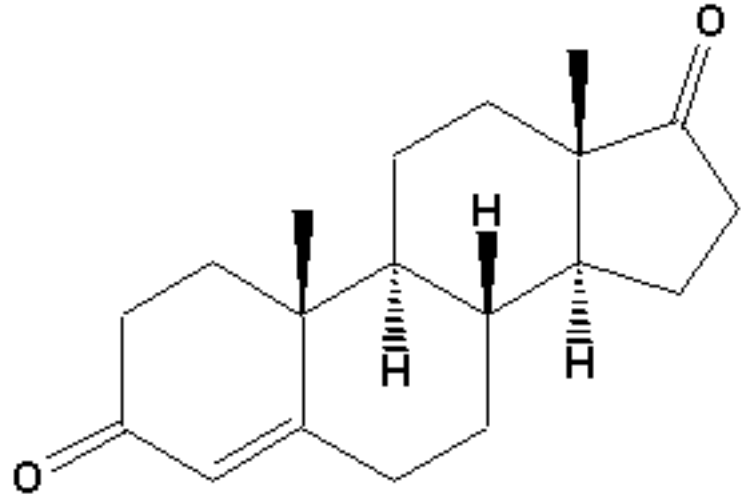

Androstenedione

Testosterone

Testosterone is an androgen, a hormone responsible for male sexual characteristics. **Testosterone** is a precursor of estrone, and estrogen ([Figure 19.24](#))

See also: [Androgens](#), [Steroid Metabolism](#), [Steroid Hormone Synthesis](#), [Steroid Hormones](#), [Estrogen](#)

INTERNET LINKS:

1. [Steroid Hormone Metabolism](#)
 2. [Androgen and Estrogen Metabolism](#)
-

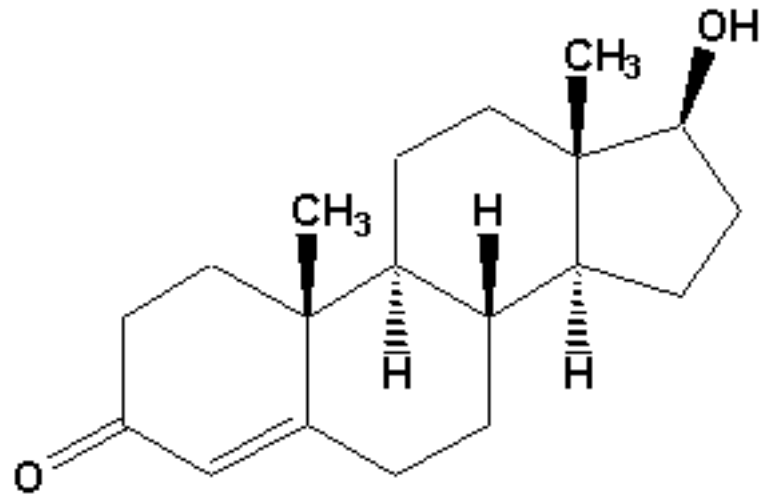

Testosterone

Figure 23.18: Action of glucocorticoids (GCs) in suppressing immune and inflammatory reactions mediated by cytokines.

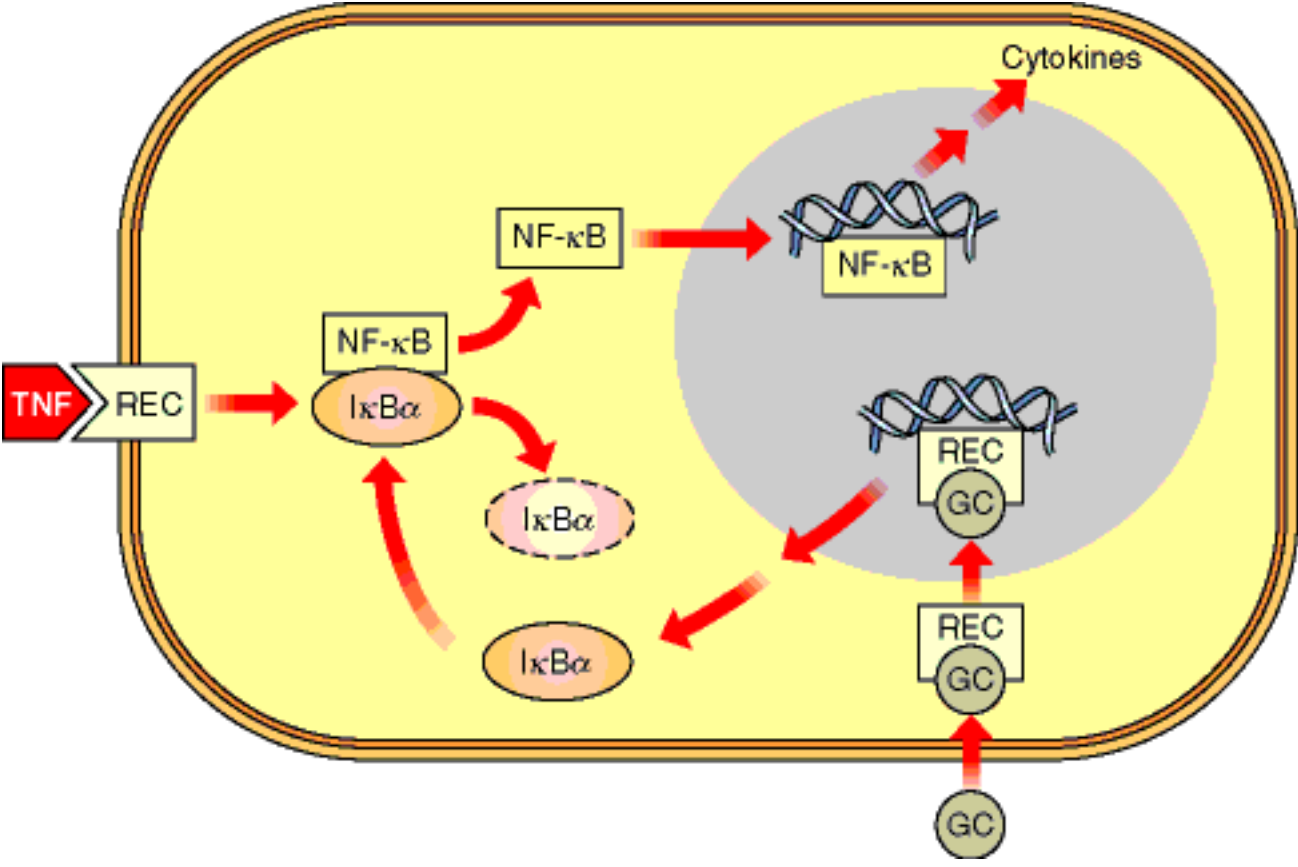

Courtesy of J. Marx, Science (1995) 270:232-233. © 1995 AAAS.

Tamoxifen

The growth of some breast tumor cells is activated by estrogen. The drug, **tamoxifen** binds to estrogen receptors without activating estrogen-responsive genes. **Tamoxifen** treatment of patients with such tumors after surgery or chemotherapy often antagonizes estrogen binding in residual tumor cells and retards their growth.

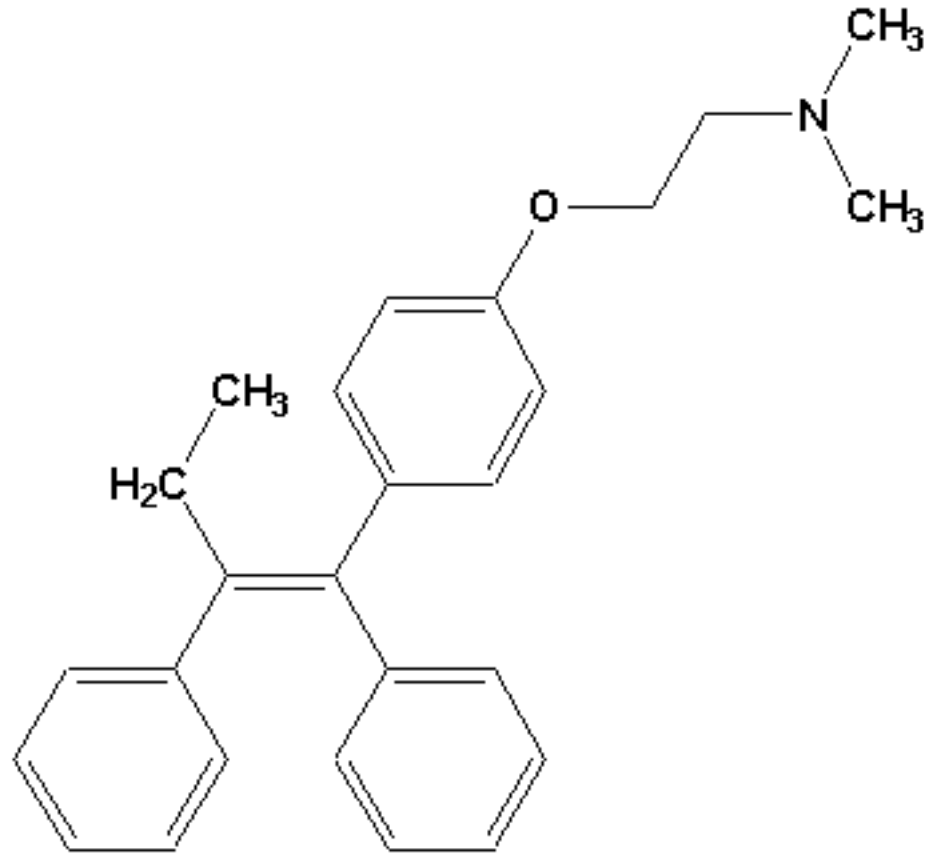

Tamoxifen

See also: [Estrogens](#), [Hormone Receptors](#), [Steroid Hormones](#), [Steroid and Thyroid Hormones - Intracellular Receptors](#)

Hormone Receptors

All known **hormones** interact with target cells by initially binding to a macromolecular receptor, located in either the plasma membrane or the interior of the cell. Because the receptor participates in transduction of the signal from the external messenger to some component of the metabolic machinery, it must have at least one additional functional site. The activity of this site is altered by hormone binding, just as the catalytic site of an allosteric enzyme is altered by the binding of effectors at remote sites. Most hormones bind tightly, with dissociation constants in the range of 0.1 μM to 1.0 pM. The ability of a tissue to respond to hormonal stimulation is a function of the receptor density of cells in that tissue.

There are three major classes of membrane-bound **hormone receptors** as follows:

1. Receptors that interact with G proteins and influence the synthesis of second messengers (See [Figure 12.13](#), and [here](#)). Peptide **hormones** and [epinephrine](#) interact with this type of **receptor**.
2. **Receptors** that form ion channels--comparable to the nicotinic acetylcholine receptor ([Figure 21.34](#)). Peptide hormones and epinephrine interact with this type of **receptor**.
3. **Receptors** that are a transmembrane protein with a ligand-binding site on the extracellular side and a catalytic domain on the cytosolic side. In the [insulin receptor](#), for example, the catalyst is a protein tyrosine kinase, which is stimulated by [insulin](#) binding to the extracellular domain of the receptor.

Mechanisms of hormones that act through membrane-bound receptors by the first and third mechanisms are summarized in [Figure 23.7](#).

The end result of most interactions between a **hormone** and a membrane receptor is activation of one or more protein kinases, whether or not a second messenger is involved. More than 100 different protein kinases have been described in vertebrate cells, and all of them are related, as determined by amino acid sequence homologies. More recent work is uncovering a host of specific protein phosphatases, also subject to control by cell signaling mechanisms.

See also: [Hormone Action](#), [Hormone Mechanisms of Action](#), [Hormone Hierarchy of Action](#), [Receptors with Protein Kinase Activity](#), [Steroid and Thyroid Hormones - Intracellular Receptors](#), [Action of Insulin](#), [Action of Glucagon](#), [Action of Epinephrine](#)

INTERNET LINKS:

1. [Thyroid Hormone Receptor Resource](#)
 2. [Nuclear Hormone Receptors](#)
-

Figure 12.13: Signal transduction pathway involving adenylate cyclase.

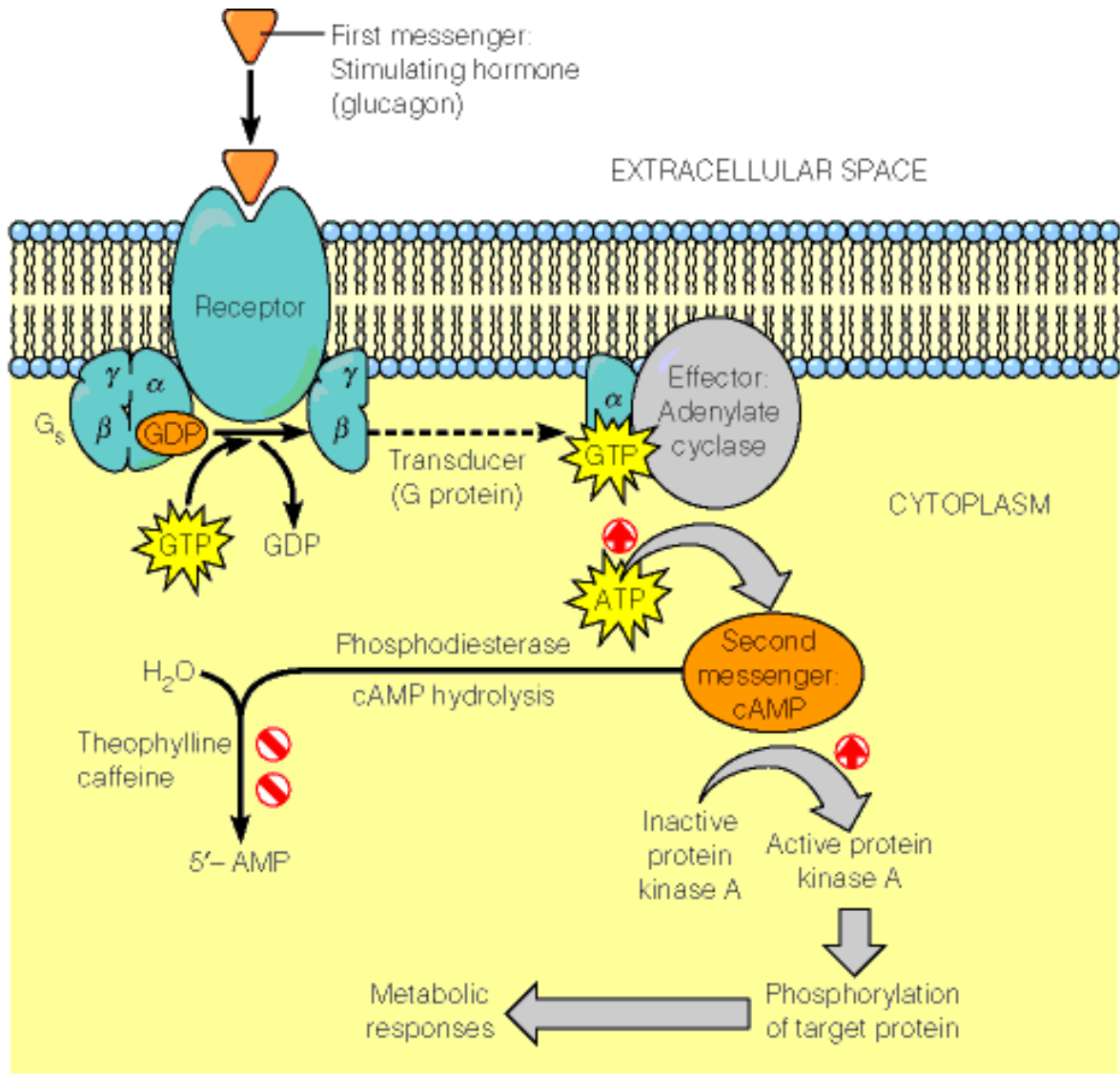
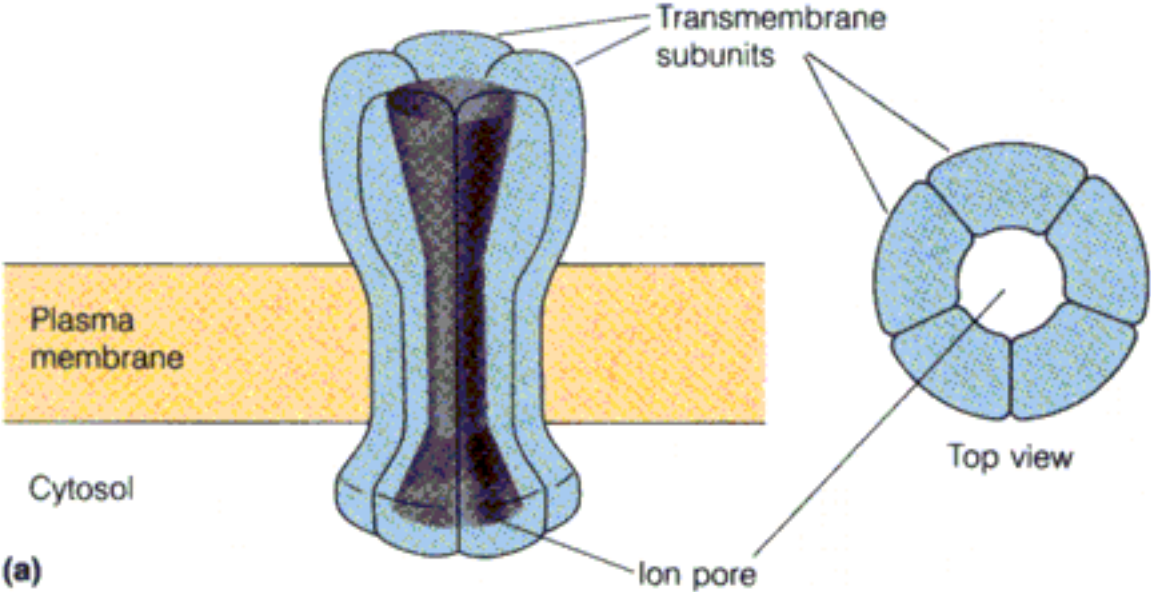
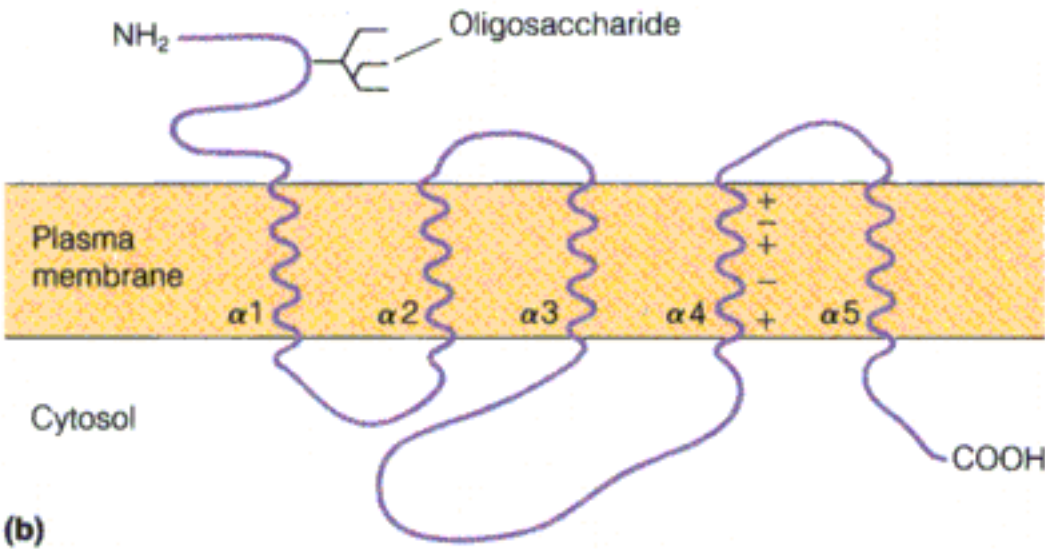

Figure 21.34: The nicotinic acetylcholine receptor.



(a)



(b)

Insulin Receptor

The **insulin receptor** ([Figure 23.15](#)) is a glycoprotein with an $\alpha_2\beta_2$ tetrameric structure, stabilized by disulfide bonds. Both the α chain (735 residues) and the β chain (620 residues) are translated from a single mRNA, giving a polypeptide chain that then undergoes proteolytic processing. The α chain, which is thought not to span the membrane, is believed to bind [insulin](#) near its C-terminus. The β chain has a transmembrane domain, with its C-terminus in the cell interior. The C-terminal region of the β chain is the site of a protein [tyrosine kinase](#) activity, which is stimulated by the binding of insulin to the extracellular part of the receptor.

The kinase activity of **insulin receptor** is essential to its biological activity, because some cases of non-insulin-dependent diabetes are associated with receptor mutations that abolish the kinase activity.

See also: [Diabetes](#), [Hormone Receptors](#), [Protein Kinase C](#)

INTERNET LINK: [Protein Kinase Classification](#)

Figure 23.15: The insulin receptor and its structural relationship to other transmembrane receptors with protein tyrosine kinase activity.

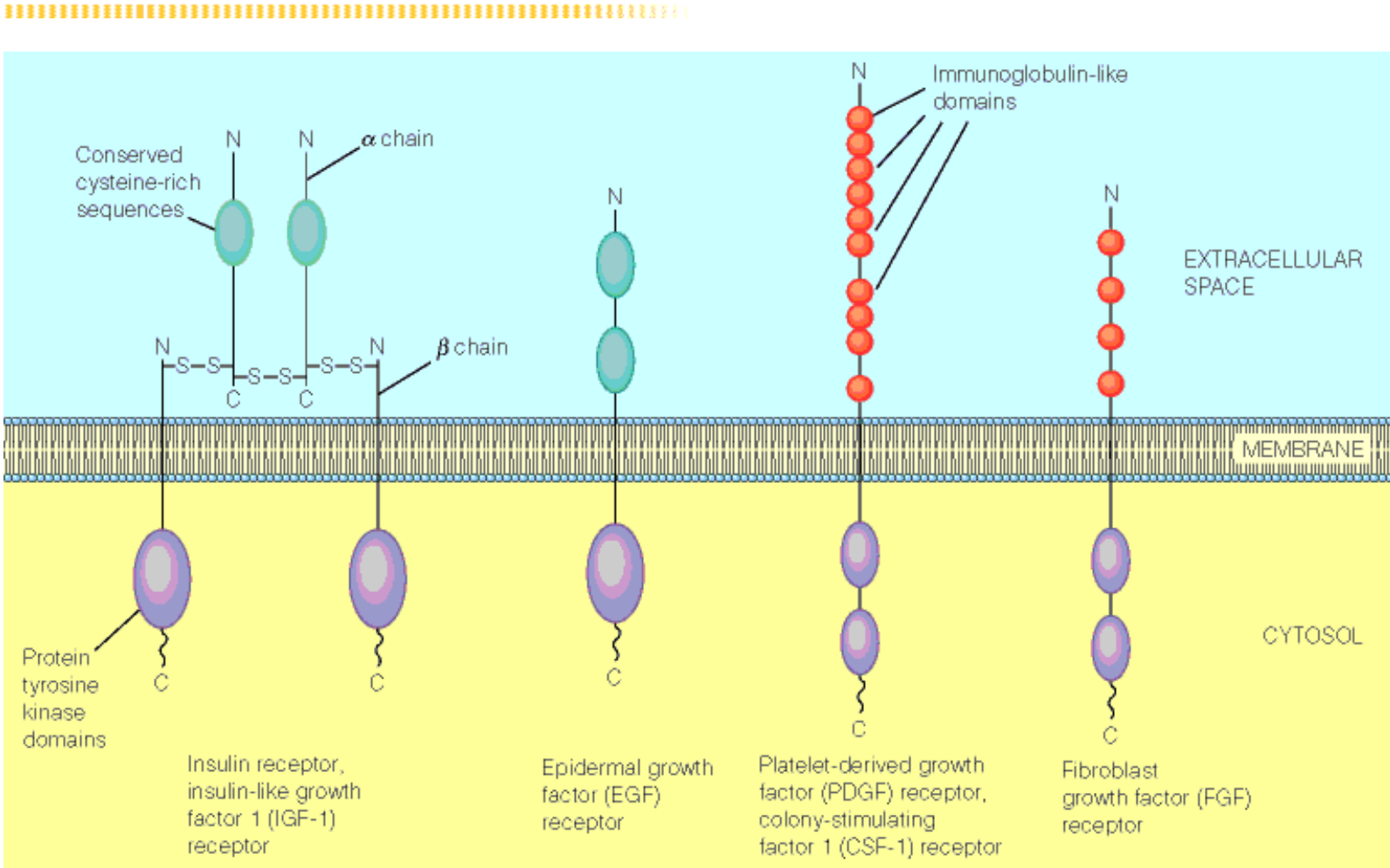

Adapted from A. Ullrich and J. Schlessinger, Cell (1990) 61:203. © 1990 Cell Press.

Tyrosine Kinase

A **tyrosine kinase** is an enzyme that phosphorylates **tyrosine**. Generally, **tyrosine kinases** act upon tyrosines in other proteins, making them **protein tyrosine kinases**. Such enzymes play important roles in cellular signalling. The **insulin receptor** (**Figure 23.15**), for example, is a **protein tyrosine kinase**.

See also: [Receptors with Protein Kinase Activity](#), [Viral and Cellular Oncogenes](#), [Oncogenes and Cell Signalling](#)

Receptors With Protein Kinase Activity

A number of hormone and growth factor receptors are distinctive in that they contain an intrinsic enzymatic activity and a single membrane-spanning domain. An example of this this class of receptors is the insulin receptor, for which no second messengers have yet been detected.

The **insulin receptor** (**Figure 23.15**) is a glycoprotein with an $\alpha_2\beta_2$ tetrameric structure, stabilized by disulfide bonds. Both the α chain (735 residues) and the β chain (620 residues) are translated from a single mRNA, giving a polypeptide chain that then undergoes proteolytic processing. The α chain, which is thought not to span the membrane, is believed to bind insulin near its C-terminus. The β chain has a transmembrane domain, with its C-terminus in the cell interior. The C-terminal region of the β chain is the site of a protein **tyrosine kinase** activity, which is stimulated by the binding of insulin to the extracellular part of the receptor.

The kinase activity is essential to the biological activity of the insulin receptor, because some cases of non-insulin-dependent diabetes are associated with receptor mutations that abolish the kinase activity.

Given that insulin can be considered a growth factor, it is of interest that protein tyrosine kinase activity is found in other growth factor receptors, too, including the following

1. Epidermal growth factor (EGF);
2. Platelet-derived growth factor (PDGF) (**Figure 23.24**);
3. Colony-stimulating factor 1 (CSF-1);
4. Fibroblast growth factor (FGF); and
5. Insulin-like growth factor 1 (IGF-1).

These receptors are a family of closely related proteins (see **Figure 23.15**), sharing amino acid sequence homology in the domains with tyrosine kinase activity. There is evidence that the action of **insulin** as a growth factor is mediated through its binding to one of these receptors, the IGF-1 receptor.

Other, more distantly related membrane receptors have other enzyme activities, such as the following:

1. Proteins of the **transforming growth factor β** (**TGF- β**) bind to a receptor that has a protein serine/threonine kinase activity (like **cAMP-dependent protein kinase**).
2. **Atrial natriuretic factor**, which controls blood volume, binds to a receptor that has

both a [guanylate cyclase](#) activity and a predicted protein serine/threonine kinase activity.

See also: [Second Messenger Systems](#), [Hormone Receptors](#), [Oncogenes and Cell Signalling](#), [Diabetes](#), [Action of Insulin](#)

INTERNET LINK: [Protein Kinase Classification](#)

Figure 23.24: The intracellular portion of the dimeric (activated) PDGF β receptor.

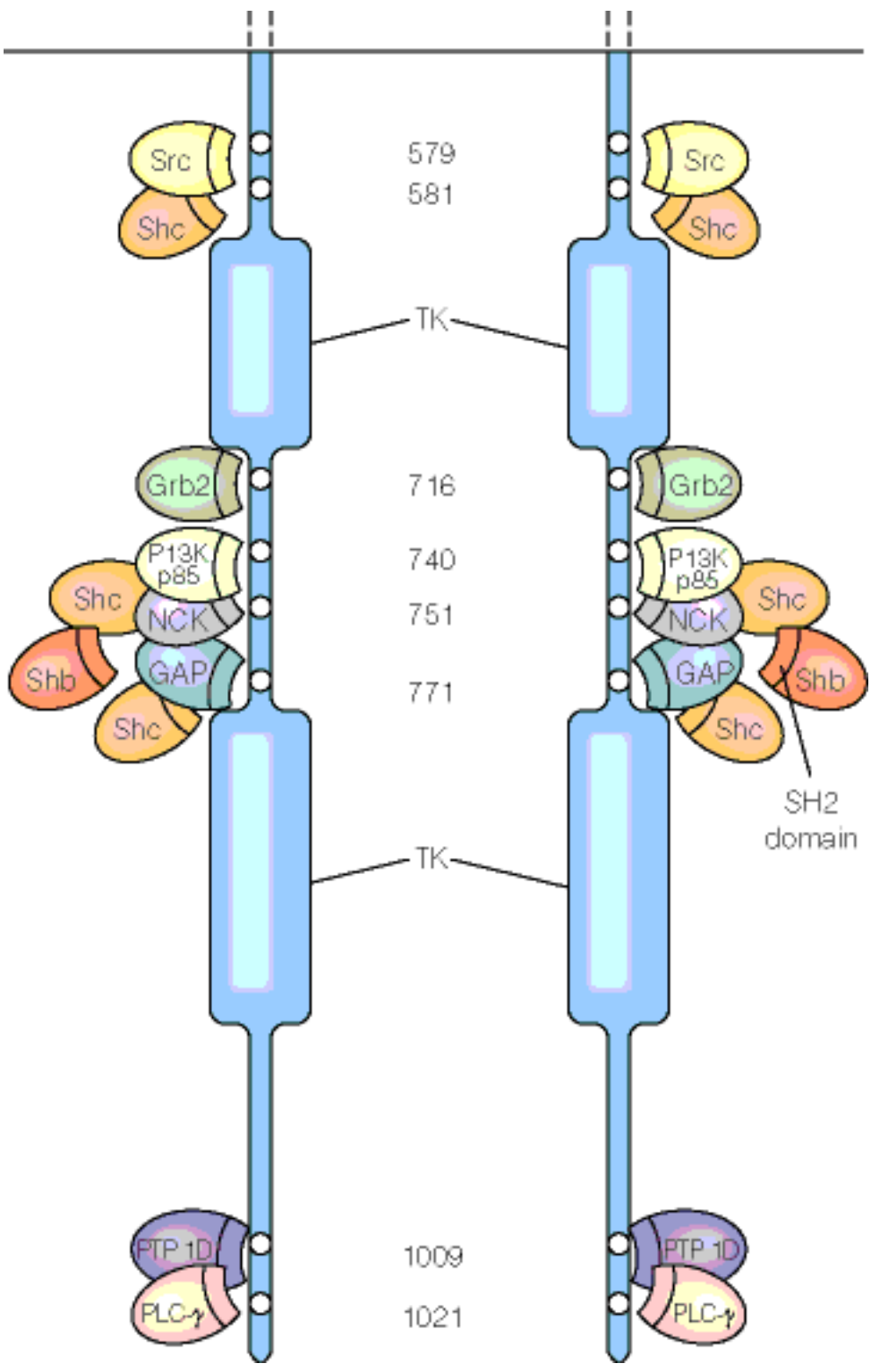

Actions of Nitric Oxide

The complex conversion of [arginine](#) to [citrulline](#) and **nitric oxide** is shown in [Figure 21.3](#). The enzyme catalyzing the reaction is [nitric oxide synthase](#).

Nitric oxide, is involved in many signaling processes in the body. For example, it is a signal-transducing agent in the vasodilation of endothelial vascular cells and underlying smooth muscle. It is also involved in signaling decreases in blood pressure, and inhibiting platelet aggregation. In the inflammatory and immune responses, an inducible form of **nitric oxide synthase** produces **nitric oxide** at levels sufficient to be toxic to pathogenic organisms. Finally, it can act in neurotransmission in the central nervous system and stimulate erection of the penis.

Nitric oxide is a gas so it can diffuse rapidly into neighboring cells and control their metabolism. It is also unstable, with a half-life of 1 to 5 seconds, so its effects are short-lived. In the cell, **nitric oxide** acts primarily by stimulating [cyclic GMP](#) synthesis. The drug, Viagra, acts by inhibiting cyclic GMP breakdown, thereby prolonging the effect of **nitric oxide**.

See also: [Glutamate as a Precursor of Other Amino Acids](#), [Nitric Oxide Synthase](#), [Arginine](#), [Citrulline](#), [Guanylate Cyclase](#)

INTERNET LINK: [The Nitric Oxide Home Page](#)

Phosphatidylinositol 4,5-Bisphosphate (PIP₂)

PIP₂ is a glycerophospholipid that is acted upon by the enzyme **phospholipase C** to yield sn-1,2-diacylglycerol (**DAG**) and inositol 1,4,5-trisphosphate (**InsP₃**). Both of these compounds act as second messengers in signal transduction.

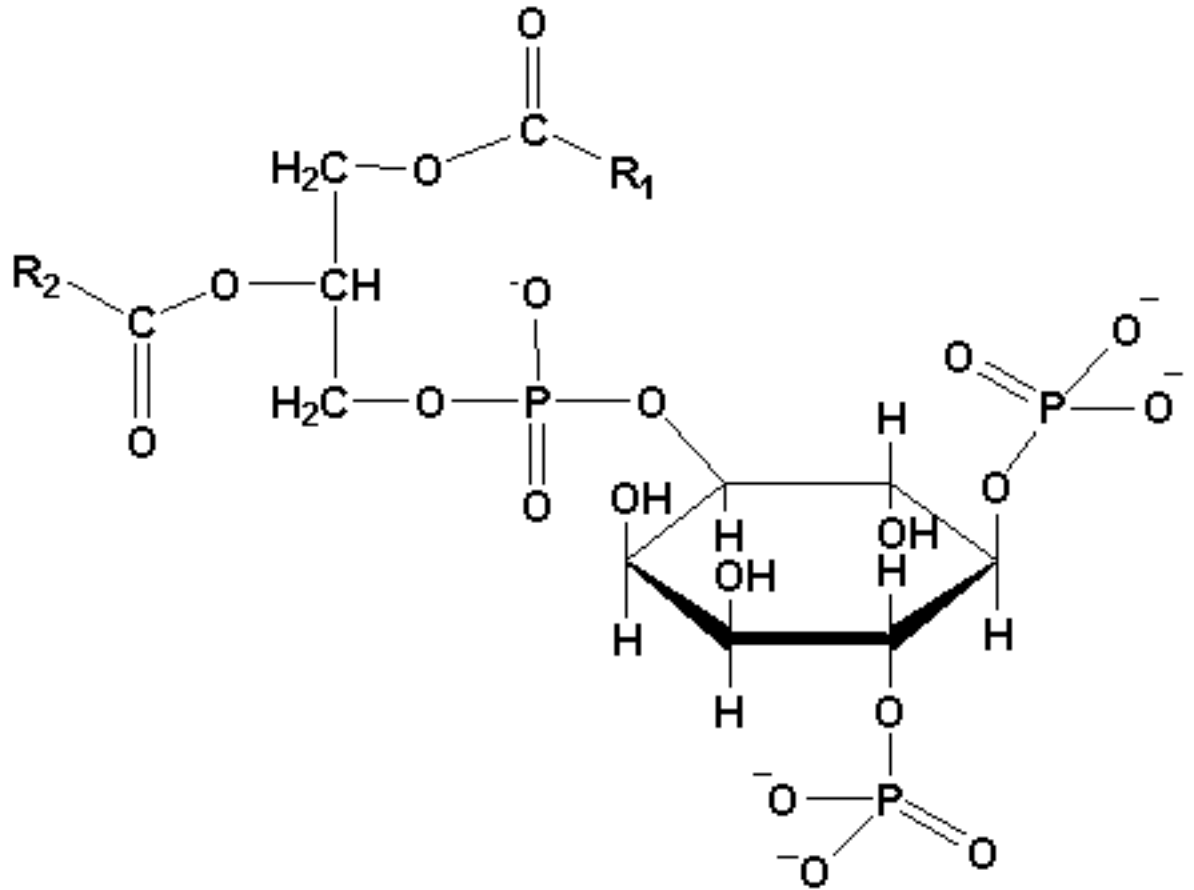

See also: [Figure 23.14, Second Messenger Systems](#)

INTERNET LINKS:

1. [Neurochemistry and Second Messenger Functions](#) **Phosphatidylinositol 4,5-bisphosphate (PIP₂)**
 2. [Second Messenger Cascades](#)
-

Phospholipase C

Phospholipase C is a phospholipase that generates two second messengers by catalyzing hydrolysis of **phosphatidylinositol 4,5-bisphosphate** (see [here](#)). The two products of the reaction, namely sn-1,2-diacylglycerol (**DAG**) and inositol 1,4,5-trisphosphate (**InsP3**), both act as second messengers in signal transduction. Therefore, the cleavage of PIP2 by phospholipase C is the functional equivalent of the synthesis of cyclic AMP by adenylate cyclase.

See also: [Second Messenger Systems](#)

INTERNET LINKS:

1. [Neurochemistry and Second Messenger Functions](#)
 2. [Second Messenger Cascades](#)
-

Inositol 1,4,5-Triphosphate (InsP₃)

InsP₃ is a second messenger in signal transduction made by cleaving **phosphatidylinositol 4,5-bisphosphate** with **phospholipase C** (see [here](#)). The two products of the reaction, **sn-1,2-diacylglycerol** and **InsP₃** both act as second messengers in signal transduction.

See also: [Figure 23.14, Second Messenger Systems, G Proteins and Signal Transduction](#)

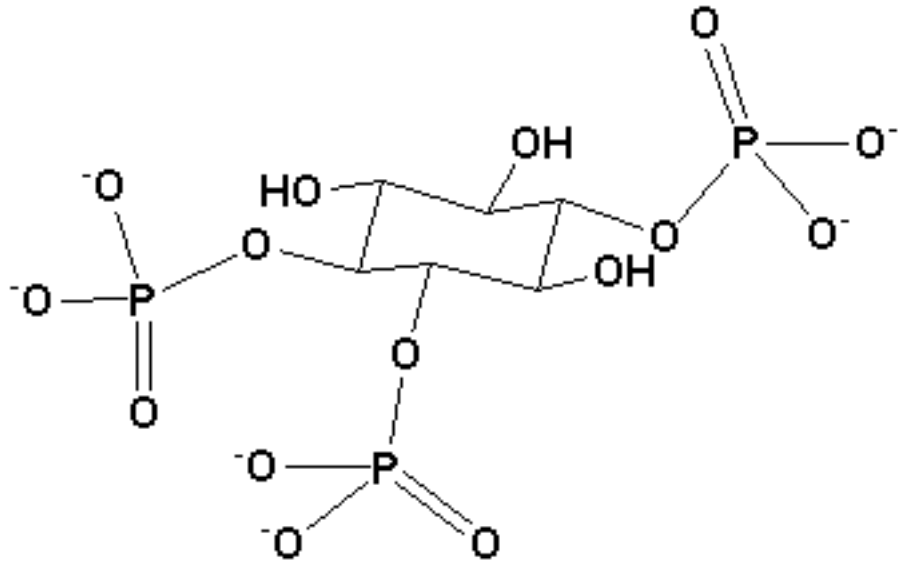

Inositol 1,4,5-triphosphate (InsP₃)

Figure 23.14: Signal transduction pathways involving phosphoinositide turnover.

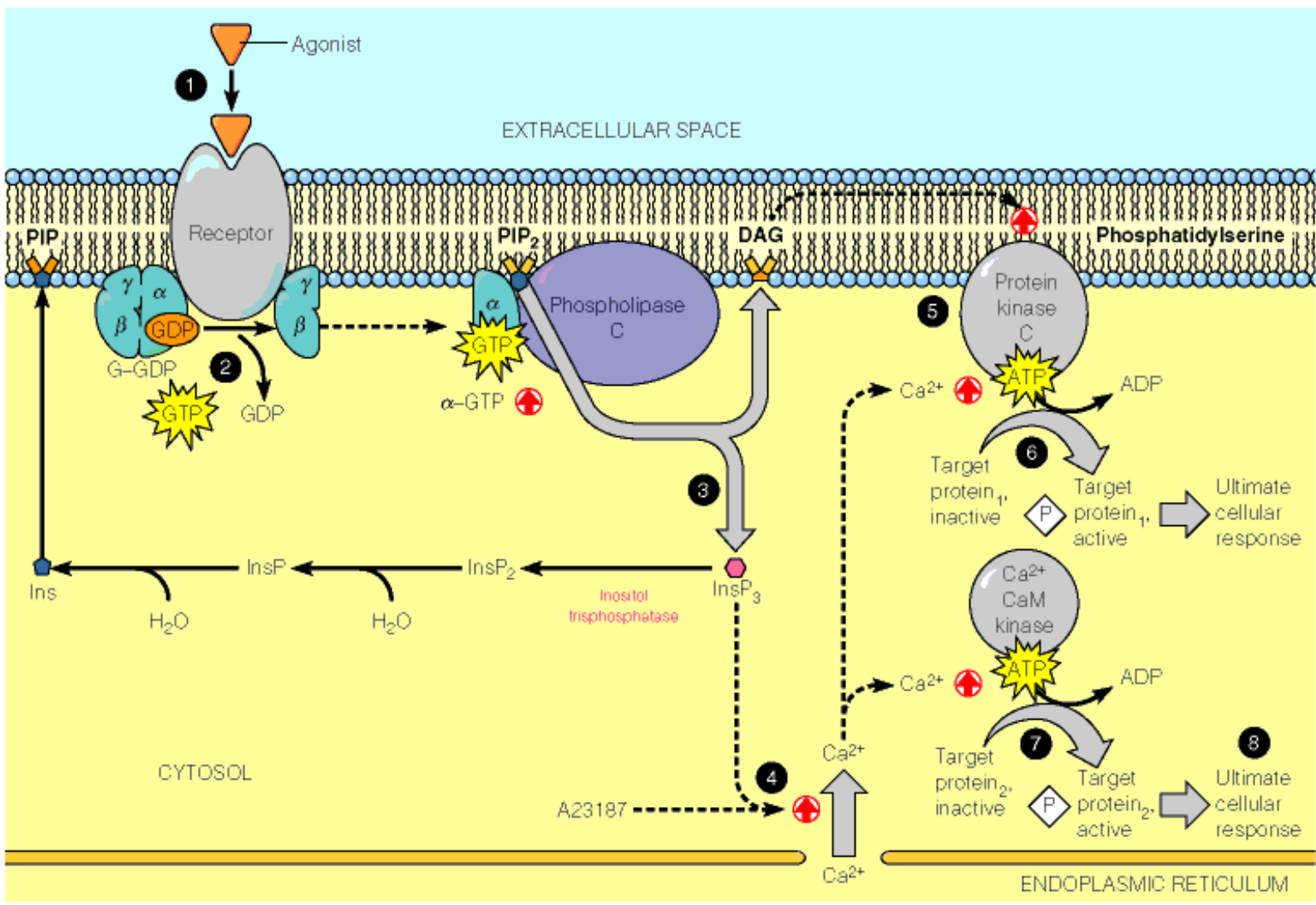

Protein Kinase C

Protein Kinase C functions in the signal transduction system involving sn-1,2-diacylglycerol (**DAG**). DAG stimulates membrane-bound **protein kinase C**, which requires calcium ion for its activity (hence the "C" designation) and a phospholipid (specifically, phosphatidylserine).

DAG, stimulates the activity of protein kinase C by greatly increasing the affinity the enzyme's affinity for calcium ions. The requirement is specific for the sn-1,2-DAG; neither the 1,3- nor the 2,3-isomer is active.

After activation, **protein kinase C** phosphorylates specific **serine** and **threonine** residues in target proteins. As with **cAMP-stimulated protein kinase**, the specific cellular responses to **protein kinase C** activation depend on the ensemble of target proteins that become phosphorylated in a given cell. Known target proteins include **calmodulin**, the **insulin receptor**, β -adrenergic receptor, glucose transporter, **HMG-CoA reductase**, **cytochrome P-450**, and tyrosine hydroxylase.

See also: [Second Messenger Systems](#)

INTERNET LINK: [Protein Kinase Classification](#)

Cytochrome P-450

Cytochrome P-450 is a name for a family of heme proteins that perform hydroxylation reactions, as well as epoxidation, peroxygenation, desulfuration, dealkylation, deamination, and dehalogenation reactions. Most vertebrate genomes contain more than 40 different structural genes for **cytochrome P-450**. The proteins resemble mitochondrial cytochrome oxidase in being able to bind both O₂ and carbon monoxide. **Cytochrome P-450** proteins are usually found in the endoplasmic reticulum of eukaryotic cells.

Cytochrome P-450 hydroxylate many compounds. These include the hydroxylations of steroid hormone synthesis and the hydroxylation of thousands of xenobiotics (foreign compounds), including drugs such as phenobarbital and environmental carcinogens such as benzpyrene, a constituent of the smoke from tobacco and backyard grills. Hydroxylation of foreign substances usually increases their solubility and is a step in their detoxification, or metabolism and excretion. In some cases, however, some of these reactions activate potentially carcinogenic substances to more reactive species. Aflatoxin B, for example, is converted to a more reactive species either by hydroxylation or epoxidation.

A key to the reactivity of **cytochrome P-450** is its ability to split O₂, with one oxygen atom binding to the cytochrome's heme iron. This bond forms a perferryl ion, which can be represented as FeO³⁺. This highly reactive group can abstract a hydrogen atom, even from an unreactive substrate such as a hydrocarbon. In such a hydroxylation, reducing equivalents are typically transferred to the cytochrome from NADPH. A general mechanism is shown in Figure 15.25. In this mechanism, substrate binding is followed by O₂ binding. Transfer of two electrons reduces one oxygen atom, such that splitting of the oxygen molecule generates water plus the perferryl ion, which then hydroxylates the substrate.

See also: Oxidases and Oxygenases, Reactive Oxygen, Heme, Second Messenger Systems

Endoplasmic Reticulum



The **endoplasmic reticulum** is a eukaryotic organelle with many functions. The outer surface of the structure is often coated with **ribosomes** undergoing protein synthesis. Proteins to be processed in other ways, such as addition of **sugars**, are synthesized and transported into the **endoplasmic reticulum**. Many biological reactions on nonpolar lipid molecules occur in the **endoplasmic reticulum**.

See also: [Figure 1.13](#), [Protein Targeting](#), [Programmed Destruction of Proteins](#), [Cholesterol Biosynthesis](#), [Biosynthesis of Glycoconjugates](#), [Cytochrome P-450](#)

Sugars

Sugars and polymers of them are known as carbohydrates because their general formulas can all be written in a simple form as $(\text{CH}_2\text{O})_x$, as if they were a hydrated form of carbon. Another term used to describe **sugar**-based molecules is rooted in the word "saccharide" (from the Latin, *saccharum*, meaning **sugar**).

Single units of **sugar**, such as [glucose](#), are called monosaccharides. **Sugars** can be readily linked together to form disaccharides (contains two **sugars**), [oligosaccharides](#) (contains several **sugars**) and [polysaccharides](#) (contains many **sugars**).

See also: [Saccharides](#), [Monosaccharide Nomenclature](#), [Derivatives of Monosaccharides](#)

Ouabain

Ouabain is a **glycoside** poison that binds to and inhibits the action of the Na^+/K^+ pump in the cell membrane (see [here](#)). The Na^+/K^+ pump is essential for maintaining the balance of these ions across cell walls.

Ouabain and **digitoxin** are used to stimulate the heart muscle. They work by binding to the Na^+/K^+ ATPase and inhibiting its action. The result of this is that Na^+ leaks back into the cell. When this happens, the cell tries to maintain the osmotic balance pumping the sodium out with the $\text{Na}^+/\text{Ca}^{2+}$ pump. This pumps Ca^{2+} into the cell, which triggers muscle contraction.

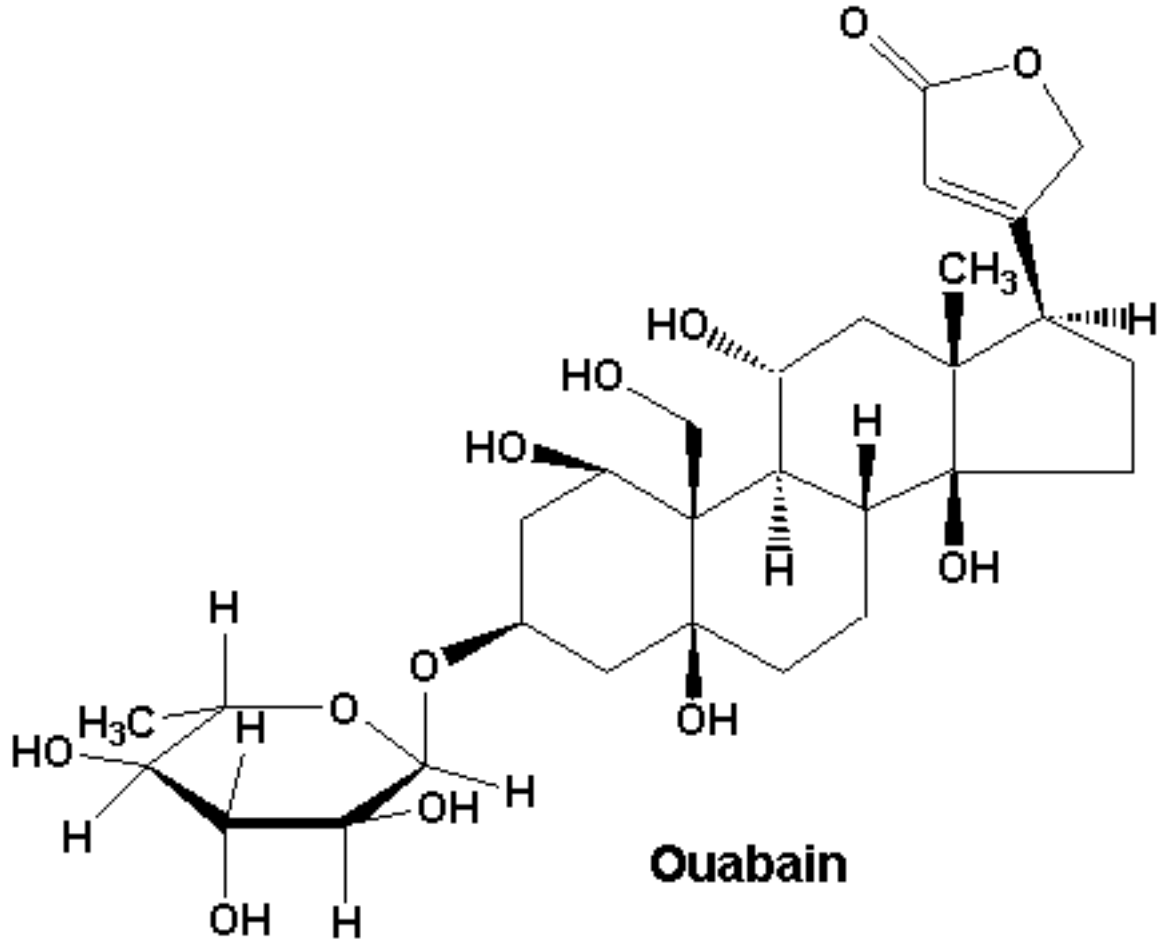

See also: [Figure 9.15](#) , [Sodium-Potassium Pump](#)

INTERNET LINK: [Sodium-Potassium Pump Animation](#) (requires Shockwave)

Sodium-Potassium Pump

The **sodium-potassium pump** (also called the **sodium-potassium ATPase**) is an ion pump in the membranes of cells that pumps sodium out as it pumps potassium into the cell ([Figure 10.25](#)). The energy source for the pumping action is the hydrolysis of ATP. The **sodium-potassium pump** is important in maintaining the osmotic balance of the cell. It can be inhibited by the **glycoside** called [ouabain](#).

See also: [Active Transport Mechanisms](#), [Digitoxin](#)

INTERNET LINK: [Sodium-Potassium Pump Animation](#) (requires Shockwave)

Figure 10.25: A model for a subunit of the Na⁺, K⁺-ATPase.

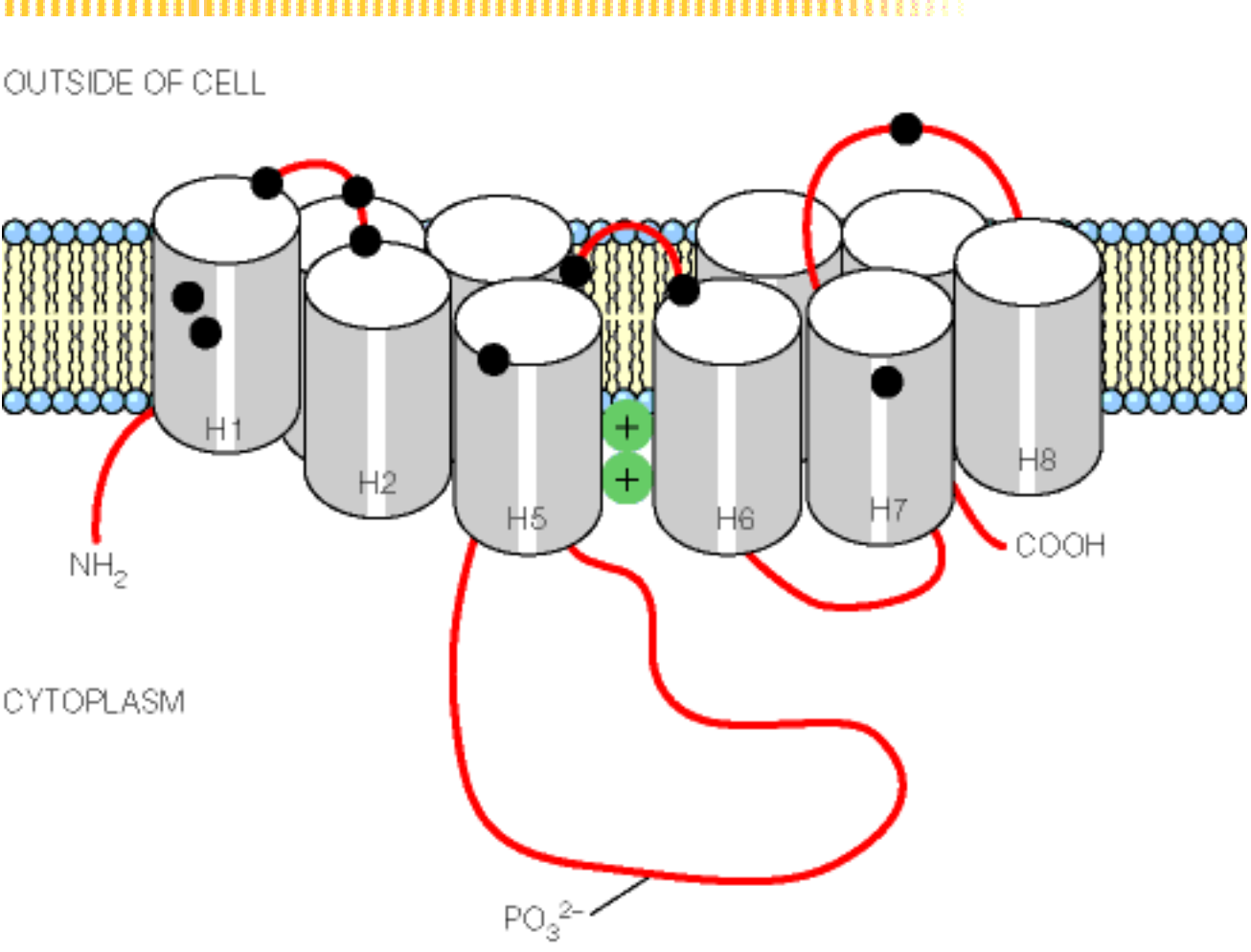

Adapted from J. B. Lingrel, J. Argüello, J. von Huisse, and J. A. Kuntzweiler, *Ann. N. Y. Acad. Sci.* (1997) 834:196–206.

Active Transport Mechanisms



Active transport mechanisms use energy sources to "pump" ions against concentration gradients. It is estimated that cells expend about 25% of their **ATP** just on **active transport**. Three common **active transport mechanisms** are described below.

Ion pumps - Directly couple ATP hydrolysis to transport. A well-studied example is the sodium-potassium pump of the plasma membrane (**Figure 10.26**). Note that in one turn of the multistep cycle, two potassiums are pumped in, three sodiums are pumped out, and one ATP is cleaved. The pump can be blocked by **ouabain** which, in the heart, stimulates contraction because sodium concentration increases and stimulates the sodium-calcium pump to remove sodium and import calcium. Increasing calcium leads to stronger muscular contraction.

Cotransport Systems - The sodium-glucose cotransport system relies on the concentration gradient built up by the sodium-potassium pump to drive the import of **glucose** into cells. In this case, sodium outside the cell binds to the receptor and, upon binding of a glucose molecule, the sodium concentration gradient drives the sodium inward and glucose is carried with it (**Figure 10.27**).

Transport by Modification - This system relies upon covalently modifying a molecule during (or shortly after) passive or facilitated transport so that it can no longer pass back through the membrane. For example, the phosphotransferase system of *E. coli* uses ATP to phosphorylate sugars as they are transported into the cell. The phosphorylated sugars cannot pass back out.

Important terminology for **active transport mechanisms**:

Antiport - moves one or more molecules in as it moves one or more molecules out

Synport - moves all molecules in same direction

Electrogenic - causes change in charge as a result of transport

Electroneutral - causes no change in charge as a result of transport

See also: [Thermodynamics of Transport Across Membranes](#), [Passive Versus Active Transport](#), [Transport Mechanisms](#), [Sodium-Potassium Pump](#)

INTERNET LINK: [Membrane Transport Mechanisms](#)

Figure 10.26: A schematic diagram of the functional cycle of the Na⁺-K⁺ pump.

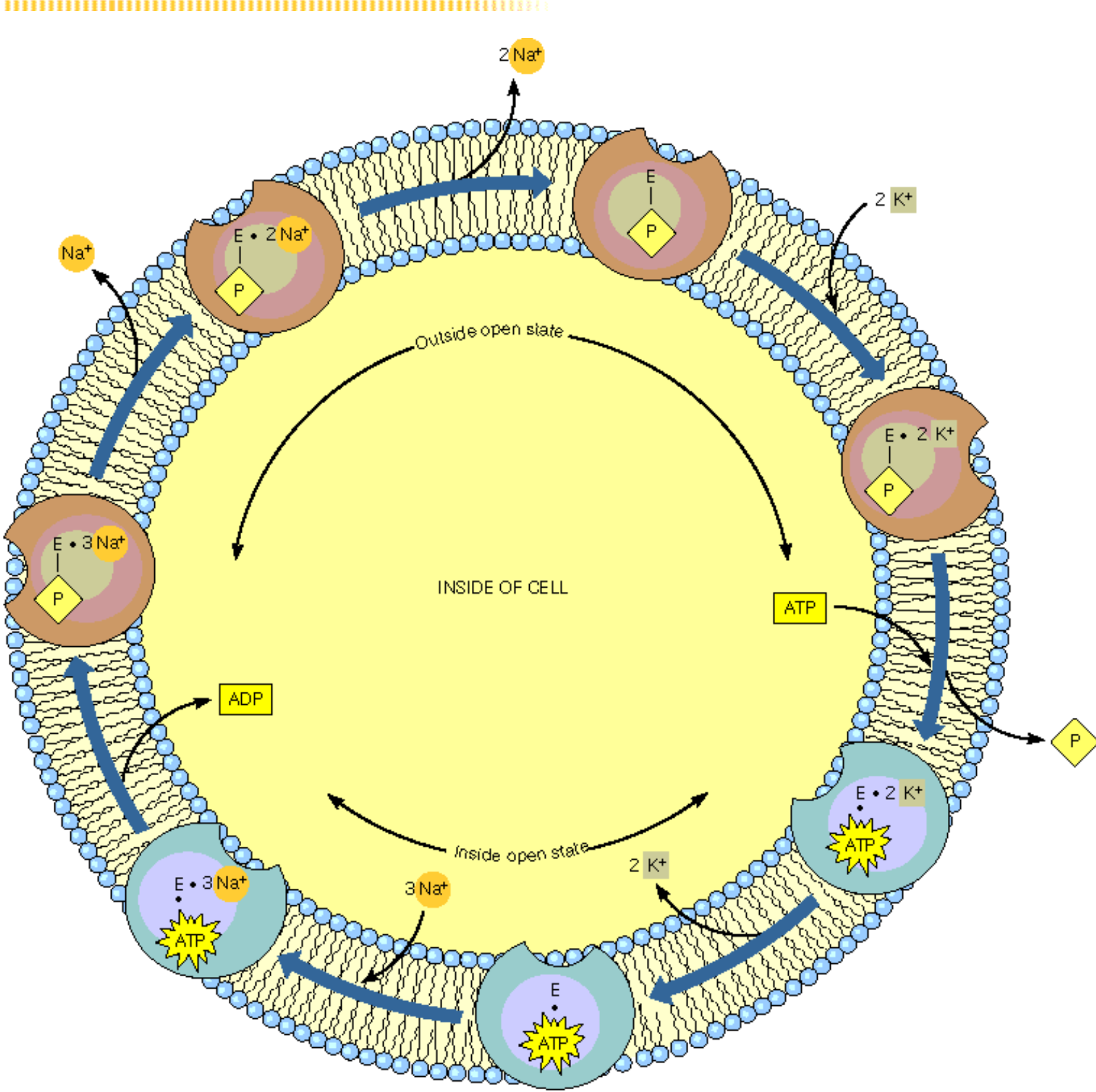
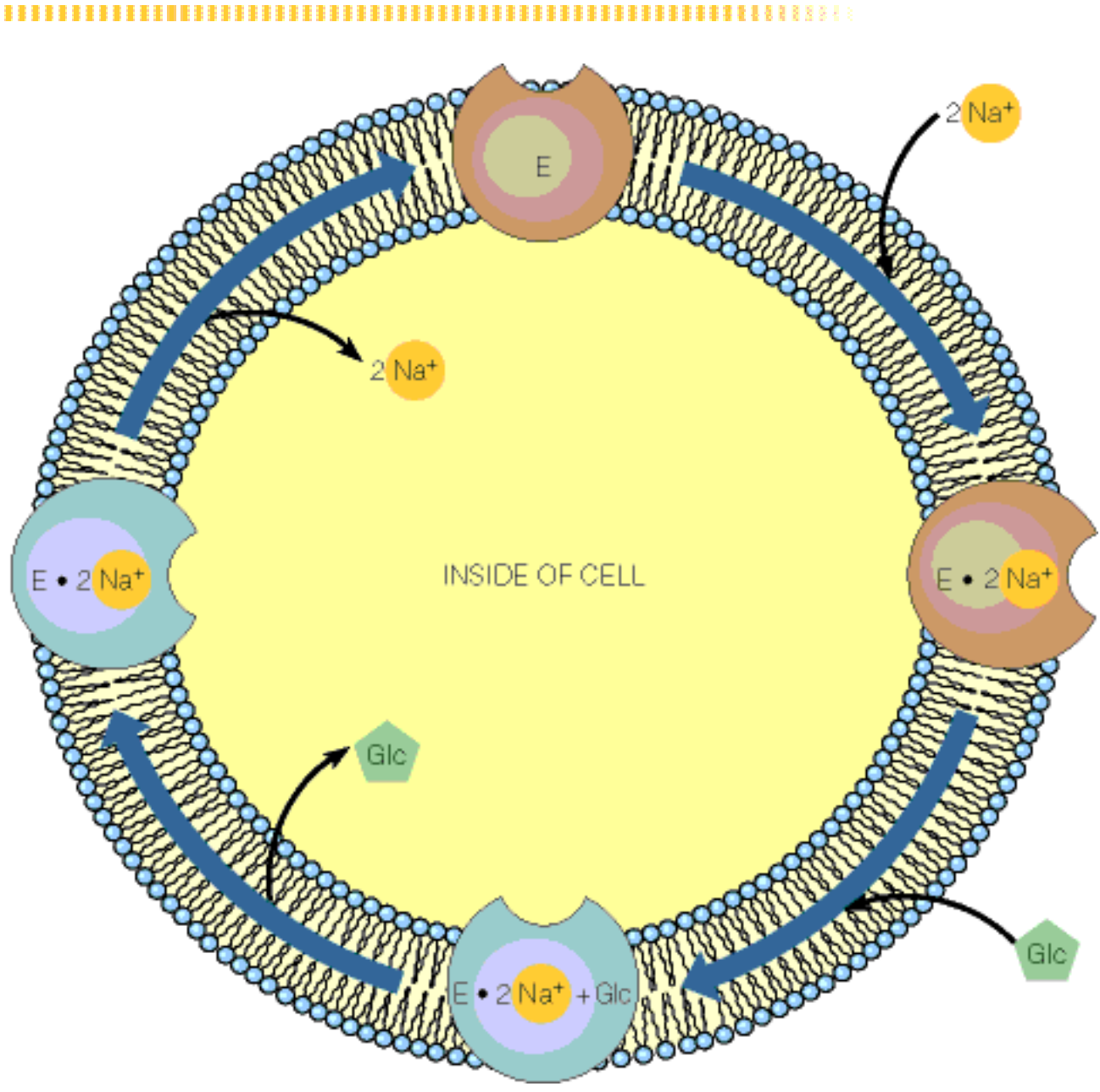

Figure 10.27: A schematic model for the sodium-glucose cotransport (symport) system.



Thermodynamics of Transport Across Membranes

Like other processes, the **Gibbs free energy** change determines the direction in which a transport process occurs. The free energy change associated with movement of compound(s) across a biological membrane is a function of 1) the relative concentration of the material on both sides of the membrane, 2) the change in charge brought about by the movement of ionic compound(s) across the membrane, and 3) other energy releasing processes coupled to the transfer, such as hydrolysis of ATP. The **Gibbs free energy** for a transfer process of compound C from outside the membrane to inside the membrane is given by

$$\Delta G = RT \ln(C_{in}/C_{out}) + \Delta G',$$

where $\Delta G'$ depends on the particular transport process as follows:

$\Delta G' = 0$ for a diffusion-based process;

$\Delta G' = ZF\Delta\Psi$ for processes where net charge differences occur. F is the Faraday constant (96.5 kJ/mol/V), $\Delta\Psi$ is the membrane potential in volts, and Z is the charge of the ion; and

$\Delta G' = \Delta G_{\text{process}}$ for processes coupled to the transport.

When ΔG for a transport is negative, movement of the compound(s) is favored in the direction for which it was calculated. If the ΔG is positive, movement is favored in the reverse direction. When $\Delta G = 0$, net movement is favored in neither direction. Note that at equilibrium for a diffusion-based process, $\Delta G = 0$, so $C_{in} = C_{out}$. Thus, a diffusion-based process results in equal concentrations of the transported molecule inside and out.

These three scenarios (differences in concentration and charge, as well as the input of chemical energy) provide forces to transport molecules across membranes and are all used in biology.

The first diffusion-based process is called a passive process, because it employs no additional input of energy ($\Delta G' = 0$) and cannot move substances against a concentration gradient (from low to high concentration). All movement of molecules in diffusion-based processes is with the gradient (from high to low concentrations).

The processes that use energy from changes in potential or from energetically favorable chemical processes are called active transport processes. They can move substances against a concentration gradient using the additional contribution from $\Delta G'$ which is not available in diffusion-driven processes. Students should be aware that both of these mechanisms can also be used to oppose transfer as well. Hence, electrical differences across a membrane may oppose a transfer instead of favor it and formation of **ATP** from ADP + Pi may be too energetically unfavorable of a barrier to allow a transfer to occur.

See also: [Transport Mechanisms](#), [Resting Potential](#), [Free Energy and Useful Work](#) (from Chapter 3), [Free Energy and Concentration](#) (from Chapter 3)

Transport Mechanisms

Transport systems for moving molecules across cell membranes are varied. Selected examples are described in the links below.

[Passive Transport Mechanisms](#)

[Active Transport Mechanisms](#)

Some of the numerous specific **transport systems** in cells are depicted in **[Figure 10.28](#)**.

See also: **[Thermodynamics of Transport Across Membranes](#)**, **[Passive Versus Active Transport](#)**

INTERNET LINK: **[Membrane Transport Mechanisms](#)**

Passive Transport Mechanisms

Passive transport mechanisms use no external energy source to bring about diffusion of a substance across a membrane. The most common **passive transport systems** are diffusion and facilitated transport.

Diffusion - Diffusion happens, and there is very little cells can do about it. [Table 10.6](#) lists permeability coefficients for selected ions and molecules through membranes. Because the driving force for diffusion is a concentration gradient, active transport pumps, such as the sodium-potassium pump, create gradients of these two ions that are continually (though slowly) degraded by diffusion. Note in [Table 10.6](#) that sodium and potassium ions do not have facilitated transport systems, so their permeability constants are very low.

Facilitated transport (or facilitated diffusion) - Includes **pore-facilitated transport** and **carrier-facilitated transport** systems. One notable feature of **facilitated transport systems** is that even though the driving force is also the process of diffusion and the end result is the same as diffusion, **facilitated transport systems** speed up diffusion by a factor of up to 10,000,000-fold.

Pore-facilitated transport - [Band 3 protein](#) of the erythrocyte is an example of a pore-facilitated transport system ([Figure 10.20a](#)). It contains a highly specific channel to transport bicarbonate ions out of cells as it transports chloride ions in. Note that the net charge difference in the transport is zero, so there is no electrical polarization of the membrane. Another kind of pore is gramicidin A, which is a simple 15-residue polypeptide that allows potassium and sodium ions to pass through it ([Figure 10.22](#)). Still another **pore-facilitated system** is that of the glucose transport protein of erythrocytes which strongly favors transport of [D-glucose](#) over other sugars.

Carrier-facilitated transport - [Valinomycin](#), an antibiotic, is an example of a **carrier-facilitated transport system**. It contains a hydrophobic exterior for interacting with the hydrophobic portion of the membrane's lipid bilayer and an interior designed specifically to accommodate a potassium ion. It transports by the mechanism depicted in [Figure 10.20b](#).

The different types of diffusion (facilitated versus simple diffusion) can be distinguished because **facilitated systems** have only a fixed number of sites through which transport occurs, but simple diffusion occurs across the entire surface of the cell. Thus, **facilitated transport** has a rate which is limited by the number of sites. Researchers attempting to increase the rate by increasing the concentration of transported molecule find that **facilitated systems** reach a maximum rate than cannot

be substantially increased with increasing concentration of molecule. **Facilitated diffusion systems** are therefore saturable. Simple **diffusion systems** do not behave in this way. They slowly increase transport simply as the concentration of transported molecule increases.

An ionophore is a system that transports ions. If the result of the transfer is a change in charge, the process is called electrogenic; if there is no charge difference, it is called electroneutral.

See also: [Thermodynamics of Transport Across Membranes](#), [Transport Mechanisms](#), [Erythrocyte Membrane](#)

INTERNET LINK: [Membrane Transport Mechanisms](#)

Table 10.6



Permeability Coefficient (cm/s) for	Synthetic Membrane (Phosphatidylserine)	Biological Membrane (Human Erythrocyte)
K ⁺	$<9 \times 10^{-13}$	2.4×10^{-10}
Na ⁺	$<1.6 \times 10^{-13}$	10^{-10}
Cl ⁻	1.5×10^{-11}	$1.4 \times 10^{-4*}$
Glucose	4×10^{-10}	$2 \times 10^{-5*}$
Water	5×10^{-3}	5×10^{-3}

Source: Data from M. K. Jain and R. C. Wagner, *Introduction to Biological Membranes* (New York: Wiley, 1980).

*Facilitated transport. Note that whenever facilitated transport is encountered, the permeability coefficient rises dramatically.

Anion Channel Protein

The anion channel protein (also called band 3 protein) is an integral membrane of the erythrocyte membrane ([Figure 10.17](#), [Figure 10.18](#)). **Anion channel protein** is an 89-kilodalton protein that appears to exist in the membrane as a dimeric structure. The polypeptide chain passes back and forth through the membrane six times. Its major function is to serve as an anion channel, allowing the passage of HCO_3^- and Cl^- through the membrane and thereby facilitate CO_2 transport by the [hemoglobin](#).

Band 3 protein does a number of additional interesting things. Its long N-terminal domain, which extends into the cytosol, may associate with a number of the [enzymes of glycolysis](#), the major energy-producing pathway in the erythrocyte. These enzymes are also involved in providing bisphosphoglycerate (see [here](#)) to regulate hemoglobin O_2 affinity. Finally, as mentioned above, the N-terminal domain of band 3 protein, which lies on the inner membrane surface, is associated with the peripheral protein ankyrin, which in turn anchors the band 3 complex to the membrane skeleton ([Figure 10.18](#)).

See also: [Membrane Proteins](#), [Erythrocyte Membrane](#), [Passive Transport Mechanisms](#), [Ankyrin](#), [Table 10.5](#)

INTERNET LINK: [Anion Channel Transmitters, Receptors, and Disease](#)

Figure 10.17: Gel electrophoretic analysis of erythrocyte membrane proteins.

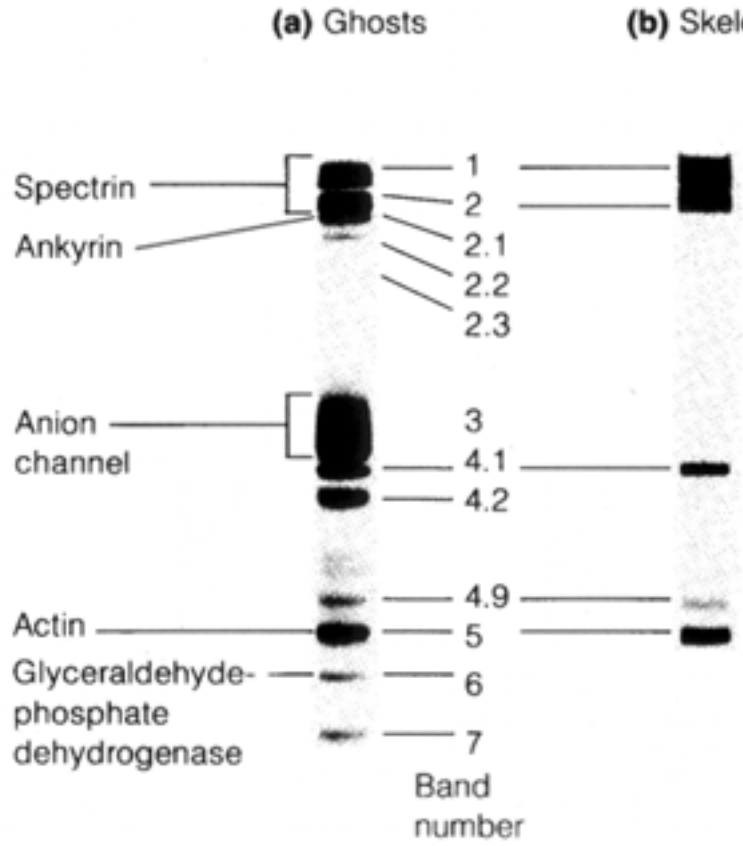

From D. Branton et al., Cell (1981) 24:24-32. © Cell Press.

Figure 10.18: Model of the postulated structure of the erythrocyte membrane skeleton.

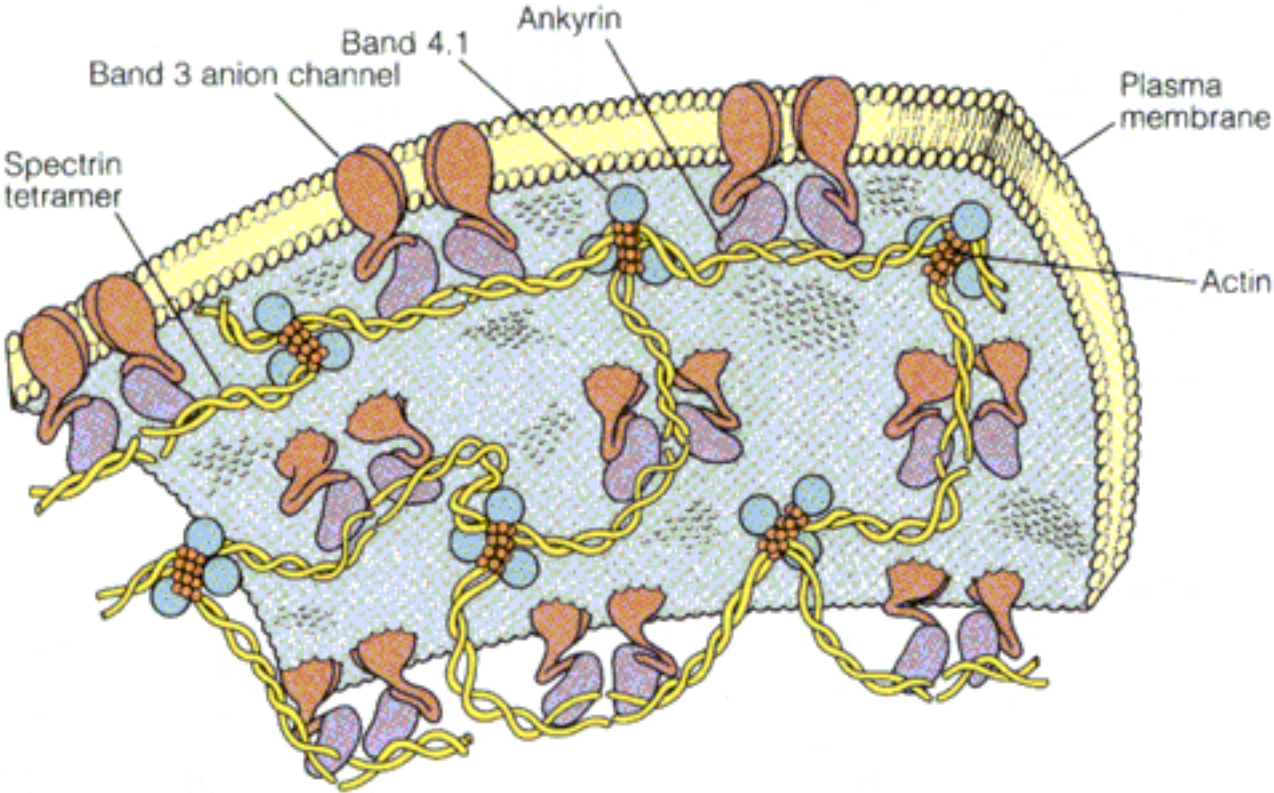

Bisphosphoglycerate and Hemoglobin

Mechanism of Action - H^+ and CO_2 function rapidly to facilitate the exchange of O_2 and CO_2 in the respiratory cycle. Like the effects of H^+ and CO_2 , binding of 2,3-bisphosphoglycerate (BPG) ([Figure 7.17](#)) acts to lower the oxygen affinity of hemoglobin. BPG binds in the cavity between the β chains ([Figure 7.18](#)), making electrostatic interactions with positively charged groups surrounding this opening. Comparison of the two hemoglobin conformations shown in [Figure 7.12b](#) reveals that this opening is much narrower in oxyhemoglobin than in deoxyhemoglobin. In fact, BPG cannot be accommodated in the oxy form. The higher the BPG content in red blood cells, the more stable the deoxy structure will be. A decrease in O_2 affinity (oxygen release) is explained by stabilization of the deoxy structure. Increased BPG levels are also found in the blood of smokers who, because of the carbon monoxide in smoke, also suffer from a limited oxygen supply.

Fetal Hemoglobin and BPG - A fetus must obtain oxygen from the mother's blood by exchange through the placenta. Fetal blood, therefore, must have a higher O_2 affinity than the mother's blood. The human fetus has a hemoglobin different from the adult form. In the fetus the β chains are replaced by similar, but distinctly different, polypeptides. These are called γ chains, so fetal hemoglobin (Hbf) has an $\alpha_2\gamma_2$ structure. The intrinsic oxygen affinity of Hbf is very similar to that of HbA, but Hbf has a much lower affinity for BPG than does HbA. This difference is largely due to the replacement of His 143 in the adult β chain by a serine in the fetal γ chain. The positively charged His 143 in adult β chains helps to bind the negatively charged BPG molecule, favoring the deoxy form ([Figure 7.18](#)). The concentration of BPG is about the same in the circulatory systems of mother and fetus. Under these conditions, Hbf will have less BPG bound than will HbA, and therefore Hbf will have a higher oxygen affinity at the same BPG concentration.

Other Effectors for Oxygen Release - The blood of birds contains inositol hexaphosphate ([Figure 7.17](#)), and fish use ATP for a similar purpose. All of these molecules have a strong negative charge and bind in the central cleft of deoxyhemoglobin. All of these allosteric effectors, including H^+ , CO_2 , and BPG, act in the same general manner-by biasing the conformational equilibrium in hemoglobin toward the deoxy form, favoring oxygen release. However, they interact at distinctly different sites, and therefore their effects can be additive, as illustrated for CO_2 and BPG in [Figure 7.19](#).

See also: [Carbon Dioxide and Hemoglobin](#), [The Bohr Effect](#)

Figure 7.17: Two anionic compounds that bind to deoxyhemoglobin.

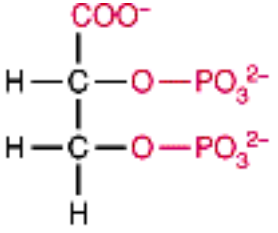

(a) 2,3-Bisphosphoglycerate

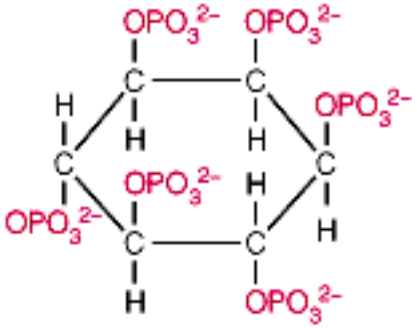

(b) Inositol hexaphosphate

Figure 7.18: Binding of 2, 3-bisphosphoglycerate to deoxyhemoglobin.

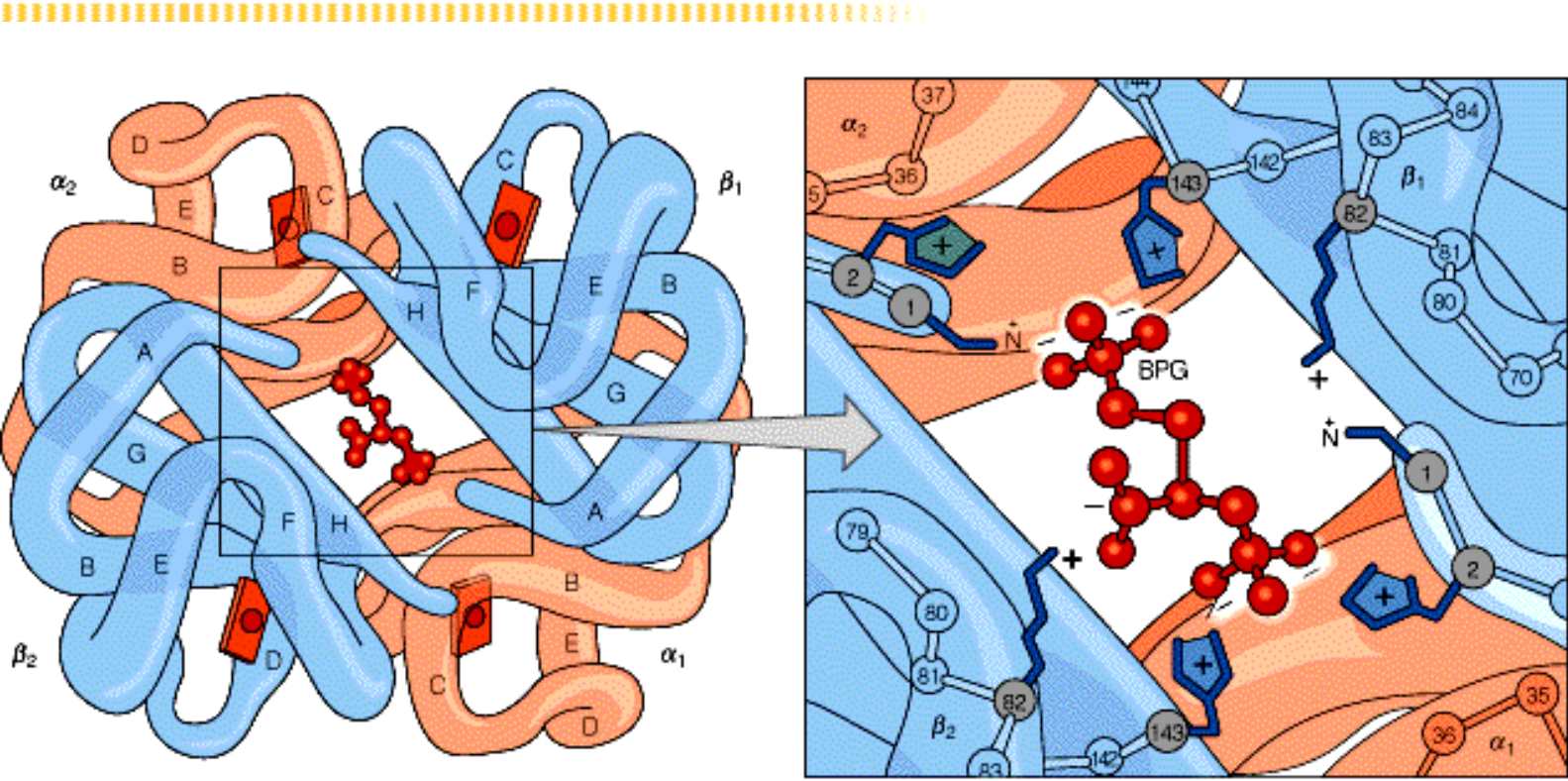

© Irving Geis.

Figure 7.12: The change in hemoglobin quaternary structure during oxygenation.

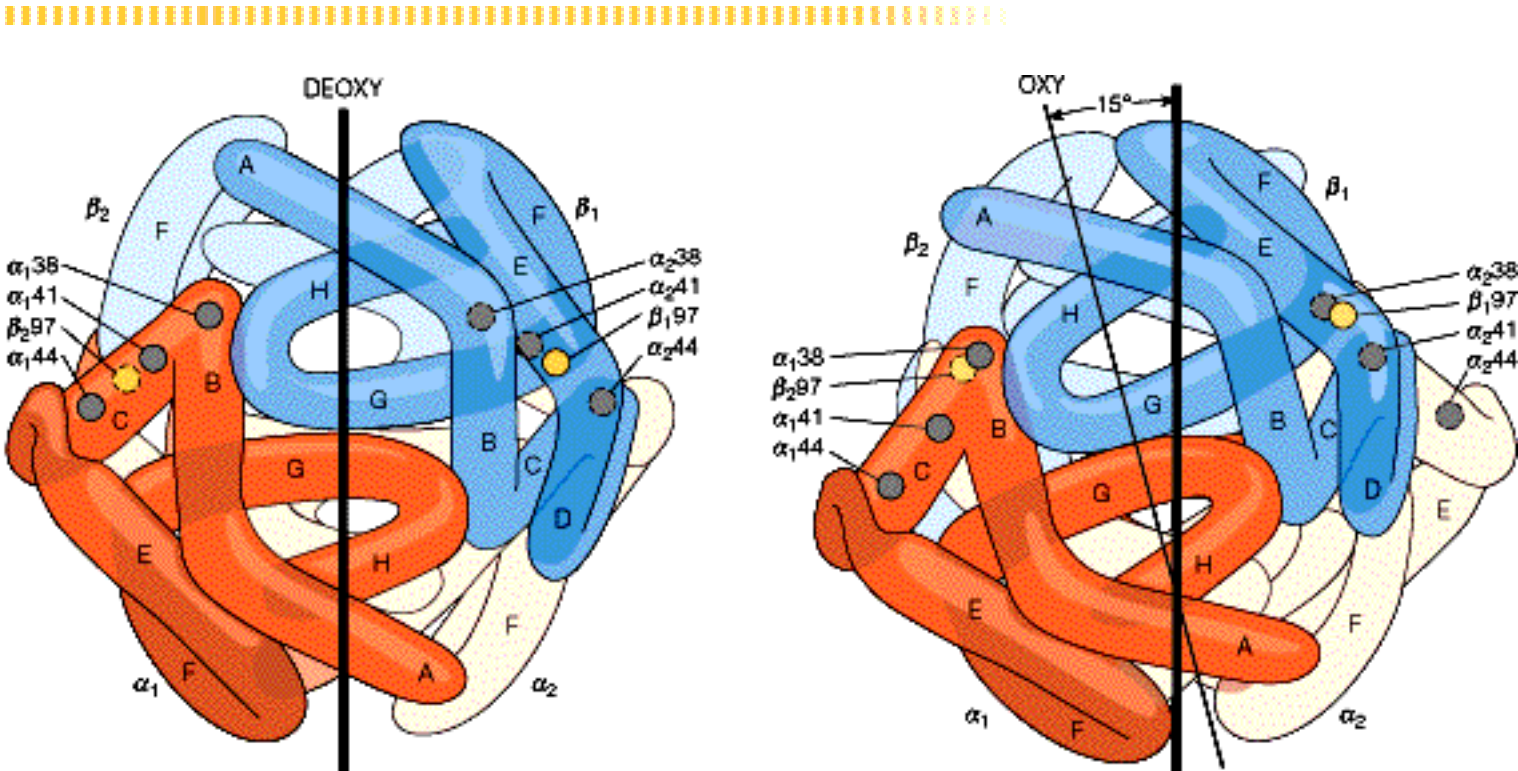

(a)

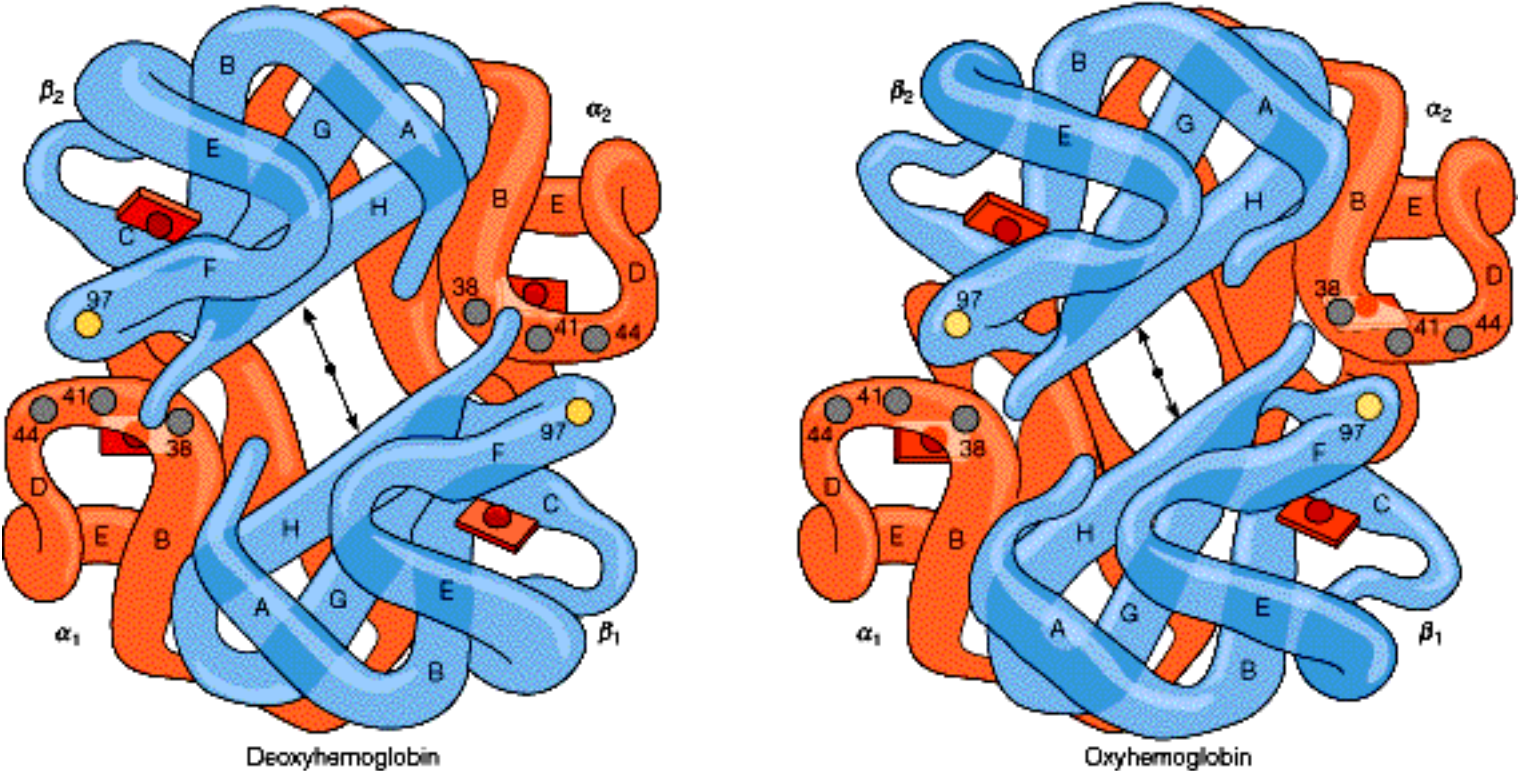

(b)

Inositol Hexaphosphate

Inositol hexaphosphate is a component of the blood of birds that favors the release of oxygen from hemoglobin by a mechanism similar to that of [2,3-bisphosphoglycerate](#) in other animals.

See also: [Bisphosphoglycerate and Hemoglobin](#)

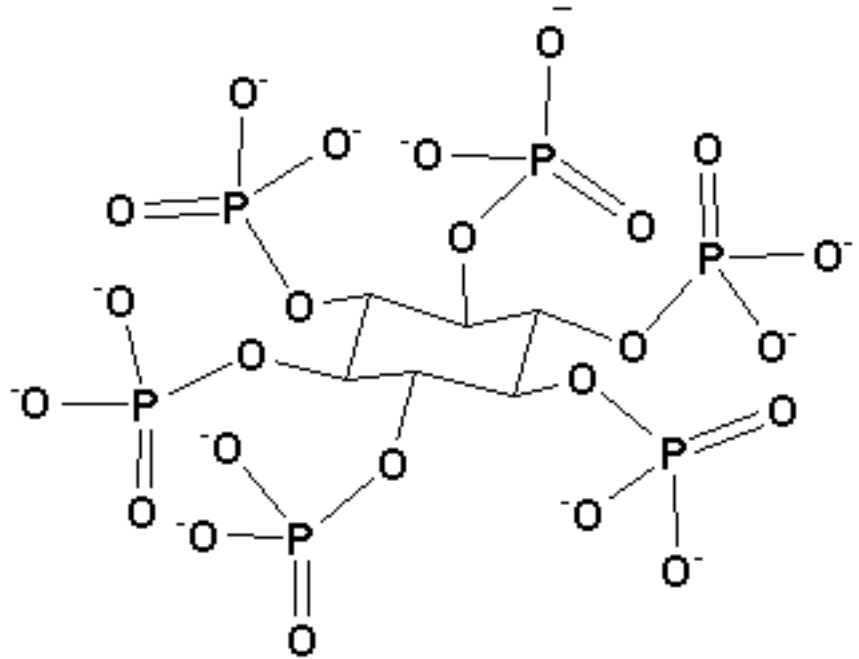

Inositol Hexaphosphate

Figure 7.19: Combined effects of CO₂ and BPG on oxygen binding by hemoglobin.

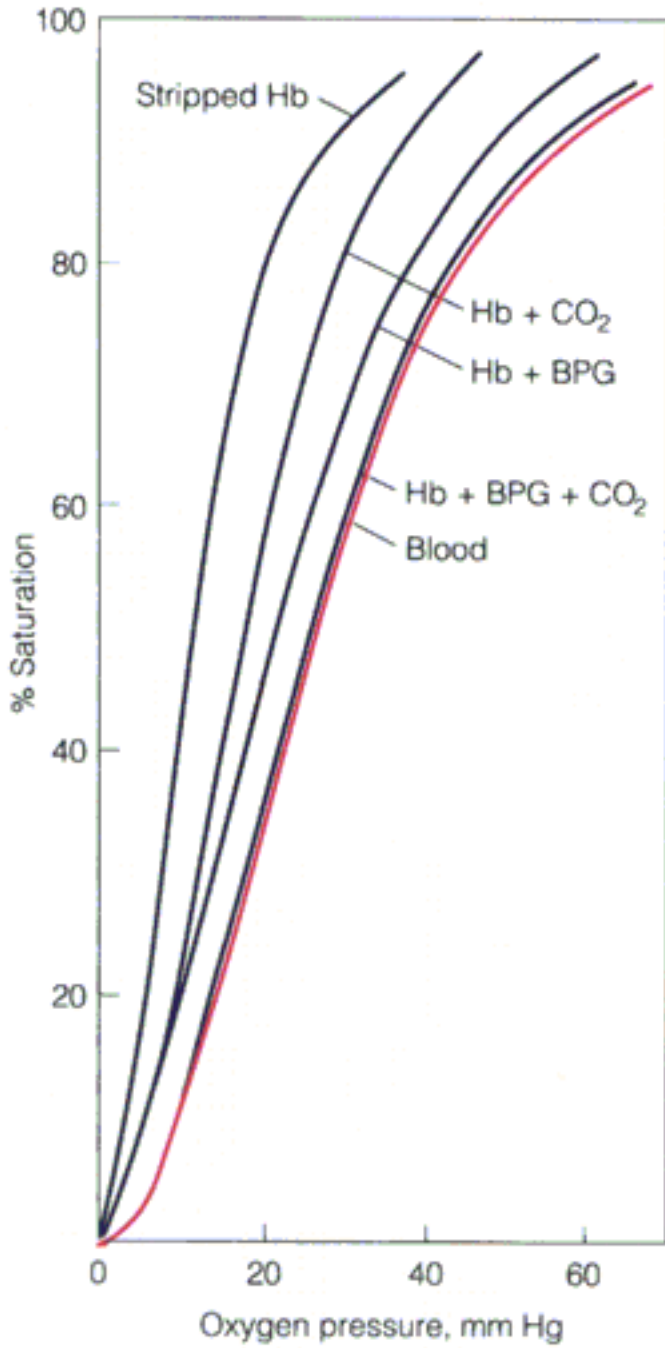

J. V. Kilmartin, Br. Med. Bull. (1976) 32:209-212.

Carbon Dioxide and Hemoglobin

Release of carbon dioxide from respiring tissues lowers the oxygen affinity of **hemoglobin** in two ways.

1. Some of the carbon dioxide becomes bicarbonate,

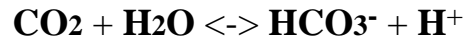

releasing protons that contribute to the **Bohr effect**.

2. Some of this bicarbonate is transported out of the erythrocytes and is carried dissolved in the blood serum. A portion reacts directly with hemoglobin, binding to the N-terminal amino groups of the chains to form carbamates, as follows:

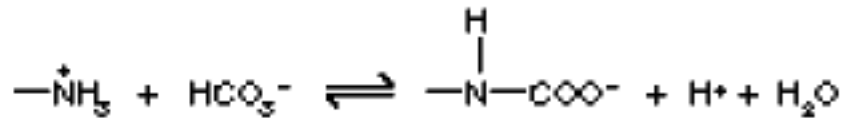

The formation of carbamates allows hemoglobin to aid in the transport of CO₂ from tissues to lungs or gills. It has two additional effects, too. First, protons released on binding of HCO₃⁻ contribute to the **Bohr effect**. Second, a negatively charged group is introduced at the N-terminus of the chains. The negatively charged group stabilizes salt bridge formation between α and β chains, which is characteristic of the deoxy state. Thus, both the latter effect and the lower pH promote oxygen release when CO₂ is abundant.

The reverse of the carbamation reaction, which occurs in lungs or gills (where O₂ concentration is high, is equally important. Here, the high O₂ concentration favors oxygenation and hence the oxy form of the molecule. When this switch occurs, stabilization of the carbamated N-termini is decreased, and CO₂ is expelled and expired.

Thus, from **Figure 7.1**, in the lungs or gills of an animal, O₂ is abundant. Oxygenation favors the oxy conformation of hemoglobin, which stimulates the release of CO₂. As the blood then travels via arteries into the tissue capillaries, the lower pH and high CO₂ concentration favor the deoxy form, promoting O₂ release and binding of CO₂. Carbon dioxide, both in forming bicarbonate and in reacting with hemoglobin, causes the release of more protons, further stimulating O₂ release and CO₂ binding.

See also: [The Bohr Effect](#), [Models of Allosteric Activity](#)

The Bohr Effect

Effect of pH Drop - A pH drop in the blood in the capillaries lowers the oxygen affinity of [hemoglobin](#), allowing even more efficient release of the last traces of oxygen. The response of hemoglobin to changes in pH is called the **Bohr effect**. The overall reaction may be written

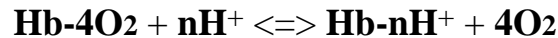

where n has a value somewhat greater than 2. Physiologically, this reaction has two consequences. First, in the capillaries, hydrogen ions promote the release of O_2 by driving the reaction to the right. Then, when the venous blood recirculates to the lungs or gills, the oxygenation has the effect of releasing the H^+ by shifting the equilibrium to the left. This, in turn, tends to release CO_2 from the bicarbonate dissolved in the blood by the reversal of the bicarbonate reaction:

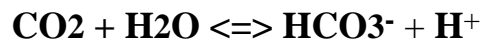

The free CO_2 can then be expired.

Mechanism of the Bohr Effect - Certain proton binding sites in hemoglobin have a higher affinity in the deoxy form than in the oxy form. A major contribution comes from [histidine](#) residue 146 at the C-terminus of each β chain. In the deoxy form, His 146 can make a salt bridge with [asp](#) 94 in the same chain, if His 146 is protonated. His 146 has an abnormally high pK_a because the salt bridge stabilizes the proton against dissociation. In the oxy form, however, this salt bridge simply cannot be formed, so the pK_a falls to its normal value of about 6.5. Consequently, at blood pH (~ 7.4), His 146 is largely unprotonated in oxyhemoglobin. Therefore, a high concentration of protons, which favors protonation, also favors the deoxy form and thus promotes the release of oxygen.

Other residues are also involved in the **Bohr effect**, including the N-terminal amino groups of the α chains. The basic mechanism is the same as for His 146. That is, protons associated with the residues are allosteric effectors favoring the deoxy conformation. The effect of lowering pH on the oxygen affinity of hemoglobin is illustrated in [Figure 7.16](#). Note that a decrease in pH of only 0.8 units shifts the P_{50} from less than 20 mm Hg to over 40 mm Hg, more than doubling the oxygen unloaded to myoglobin.

See also: [Models of Allosteric Activity](#), [Hemoglobin Allostery](#)

Figure 7.16: The Bohr effect in hemoglobin.

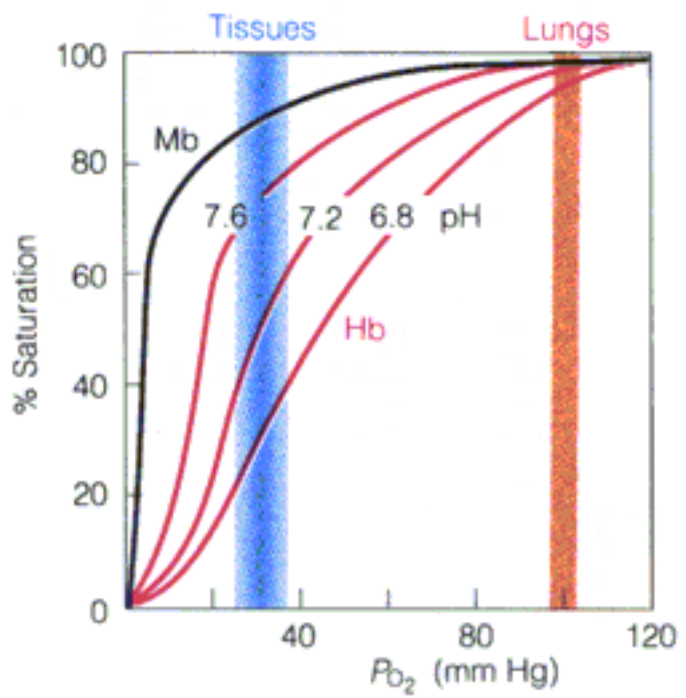

Models of Allosteric Activity

Several theories have been developed to describe allosteric transitions. They may be generally grouped into the following three classes:

- 1. Sequential models:** The prototype for the models that describe allosteric transitions is the sequential model of Koshland, Nemethy, and Filmer (KNF) ([Figure 7.10a](#)). The KNF model assumes that the subunits can change their tertiary conformation one at a time in response to binding of oxygen. Cooperativity arises because the presence of some subunits carrying oxygen favors the strong-binding state in adjacent subunits whose sites are not yet filled. Thus, as oxygenation progresses, almost all the sites become strong-binding. Such models are characterized by the existence of molecules with some subunits in the weak-binding state and some in the strong.
- 2. Concerted models:** According to the theory of Monod, Wyman, and Changeux (MWC) ([Figure 7.10b](#)), the entire [hemoglobin](#) tetramer exists in an equilibrium between two forms - the deoxy (T) state, in which all subunits in each molecule are in the weak-binding conformation, and the oxy (R) state, in which all subunits are in the strong-binding form. (The symbols "T" and "R" stand for "tense" and "relaxed"; the significance of this is explained in the next section.) An equilibrium between the T and R states is presumed to exist, and partial oxygenation shifts that equilibrium toward the R state. The shift is a concerted one (different from the sequential model above), so that mixed molecules with some subunits in the weak-binding state and some in the strong-binding state are specifically excluded.
- 3. Multistate models:** Neither the KNF nor the MWC model exactly explains the allosteric behavior of proteins, including hemoglobin. Consequently, more complex models have been devised. Most such models retain the MWC concept of a concerted switch in conformation but involve more than two states for the entire molecule.

Transitions and Subunit-Subunit Interaction - Transition from the deoxy to the oxy conformation involves major changes in the details of subunit-subunit interaction. Note the region in [Figure 7.12b](#), to the lower left, where the β_2 subunit interacts with the α_1 chain. In the deoxy form, the C-terminus of β_2 (residue 146) lies atop the C helix of α_1 (residues 36–42) and is held in this position by a network of hydrogen bonds and salt bridges. His 97 in the FG corner of β_2 is pushed against the CD corner of α_1 , between Thr 41 and Pro 44. In the oxy form, rotation and sliding of the subunits have pulled the C-termini of β chains away from α contacts ([Figure 7.12b](#)). The salt bridges and hydrogen bonds holding the C-terminus have been broken, and His 97 of β_2 now lies between Thr 38 and Thr 41 of α_1 . Because of the symmetry of the structure, an exactly equivalent set of changes occurs at the $\alpha_2\beta_1$ interface. The molecule has, as it were, "switched" and clicked into a new set of interactions. In the process, a number

of strong interactions (those involving the C-termini in particular) have been broken. The looser conformation is called relaxed (R). The energy price for the change from the T state to the R state is paid by the binding of O₂ to the molecule. Once the O₂ has departed, the molecule will naturally fall back into its lower-energy deoxy conformation. This tighter conformation is called tense (T).

O₂ Binding and Molecular Switching - [Figure 7.13](#) shows the relationship of His F8 and the neighboring Val (FG5) to the heme in deoxyhemoglobin. The iron atom in the deoxy conformation is a bit above the mean heme plane, but also the heme itself is not quite flat. Instead, it is distorted into a dome shape. Furthermore, in both deoxymyoglobin and deoxyhemoglobin, the axis of His F8 is not exactly perpendicular to the heme but is tilted by about 8°. When oxygen binds to the other side, it pulls the iron atom a short distance down into the heme and flattens the heme ([Figure 7.13b,c](#)). This change causes molecular rearrangement, for without it, both the ε-hydrogen of His F8 and the side chain of Val FG5 would be too close to the heme. Consequently, the histidine changes its orientation toward the perpendicular, shifting the F helix and the FG corner in the process. This movement in turn distorts and weakens the whole complex of H bonds and salt bridges that connect FG corners of one subunit with C helices of another. Consequently, the rearrangement shown in [Figure 7.12](#) occurs.

In the simplest terms, the binding of O₂ pulls the iron a fraction of a nanometer into the heme, producing a lever effect which results in a much larger shift in the surrounding structure, particularly at the critical α-β interfaces. These changes constitute a rearrangement of the tertiary structure of each subunit upon oxygen binding.

A major rearrangement of the quaternary structure also occurs between the fully deoxy and fully oxy (T and R) states of the entire tetramer. How are the tertiary and quaternary structural changes connected? [Figure 7.15](#) shows that the changes in tertiary structure that accompany oxygen binding can be tolerated up to a certain point before the T-R switch occurs. Specifically, whenever one site is occupied on each of the two α-β dimers, the molecule as a whole adopts the R quaternary structure.

Thus, hemoglobin obeys neither the KNF nor the MWC model completely but follows a novel path containing features of both models. This more recent model does not mean that the earlier models are generally incorrect. Allosteric proteins exist that appear to follow the MWC model almost exactly.

Other Allosteric Effectors - Cooperative binding and the transport of oxygen are only part of the allosteric behavior of hemoglobin. As oxygen is utilized in tissues, carbon dioxide is produced and must be transported back to the lungs or gills to be expelled from the organism. Accumulation of CO₂ lowers the pH in erythrocytes through the bicarbonate reaction,



This reaction in erythrocytes is catalyzed by the enzyme carbonic anhydrase. High demand for oxygen, especially in muscle involved in vigorous activity, can result in oxygen deficit. A consequence of oxygen deficit is the production of lactic acid, which also lowers the pH. The falling pH in tissue and







venous blood signals a demand for more oxygen.

Hemoglobin functions efficiently to meet these requirements. It does so through its allosteric transition between structurally different high-affinity and low-affinity states. Carbon dioxide, protons, and other substances all affect hemoglobin and promote allosteric changes.

See also: [Hemoglobin Allostery](#), [The Bohr Effect](#), [Carbon Dioxide and Hemoglobin](#), [Bisphosphoglycerate and Hemoglobin](#)

Figure 7.10: Two models for the cooperative transition of hemoglobin.

Key:

-  Hb subunits, weak-binding state
-  Hb subunits, strong-binding state
-  Hb tetramer, T state
-  Hb tetramer, R state
-  Oxygen
-  No oxygen bound
-  Oxygen bound

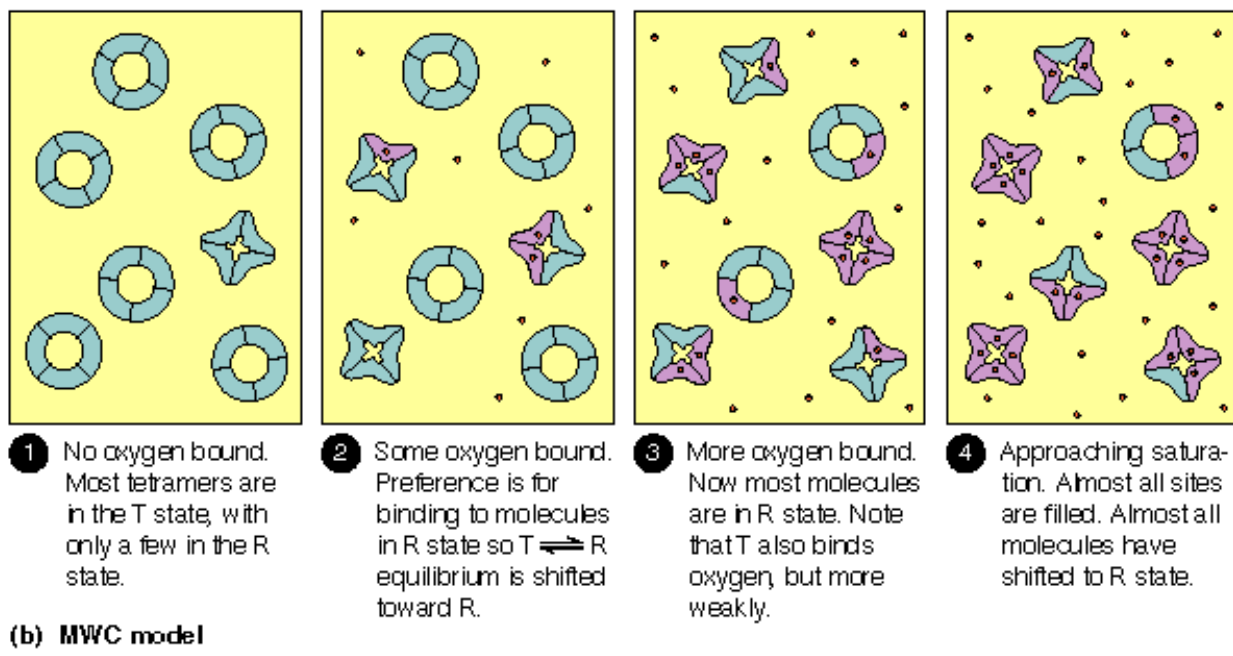
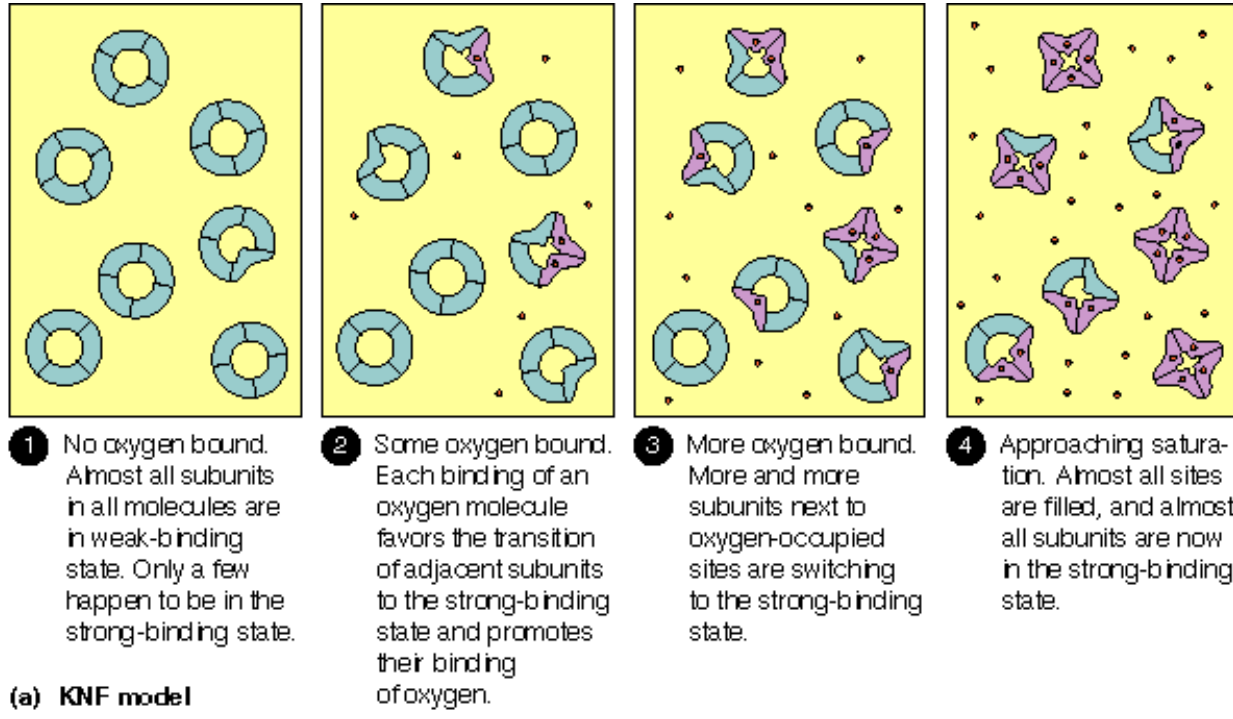

Figure 7.13: Mechanism of the T R transition in hemoglobin.

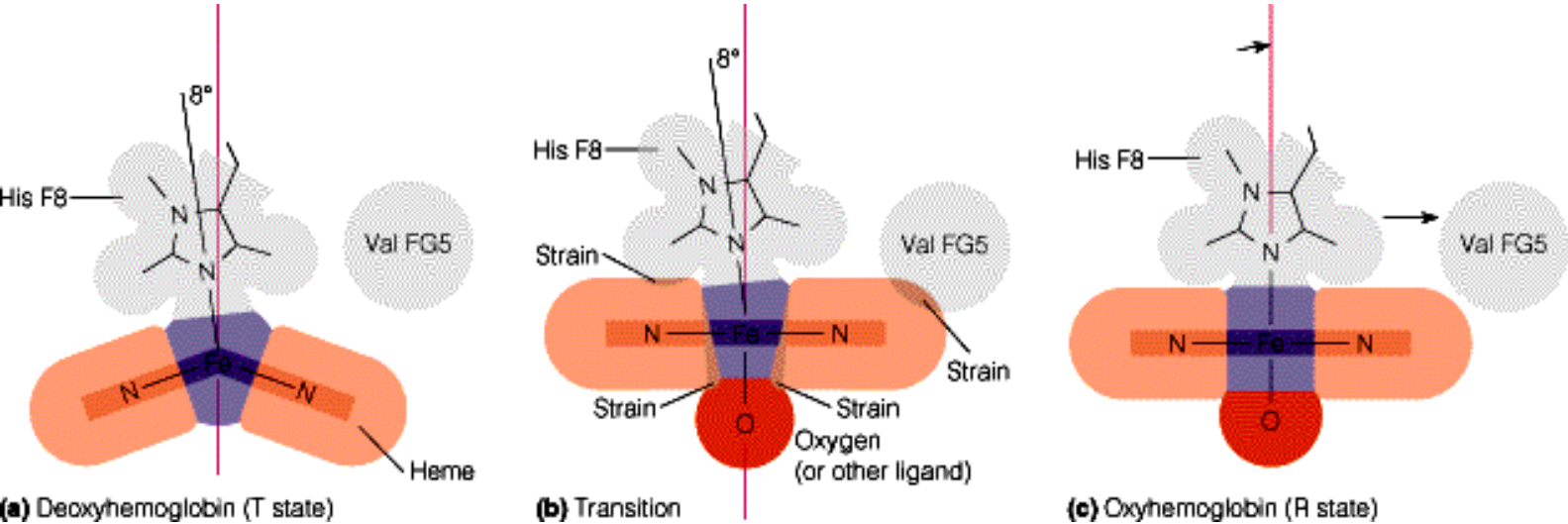
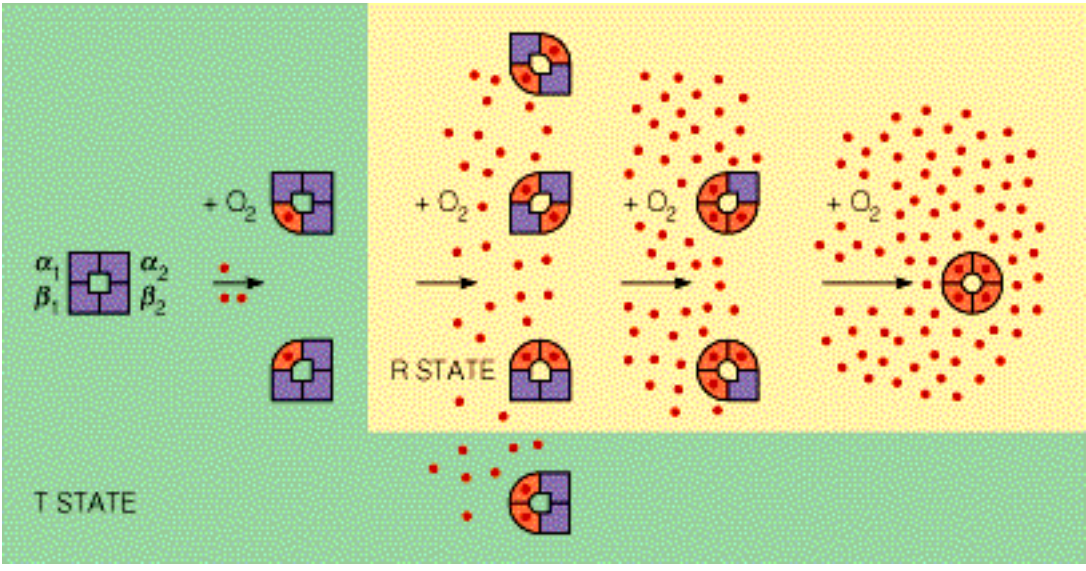

Figure 7.15: A recent model for the cooperative transition of hemoglobin.



Adapted from G. K. Ackers et al., Science (1992) 255:54-63. © 1992 American Association for the Advancement of Science.

Hemoglobin Allostery

Structure - Hemoglobin of higher vertebrates is made up of two types of chains, referred to as α and β . The **hemoglobin** molecule contains two of each kind of chain, so the whole molecule can be called an $\alpha_2\beta_2$ tetramer. The chains are placed in a roughly tetrahedral arrangement as shown schematically in [Figure 7.3](#). Their primary structures (amino acid sequences) are compared with that of myoglobin in [Figure 7.11](#). The α and β sequences have considerable similarity to one another and some similarity to that of myoglobin. Essential residues, like the proximal and distal **histidine** (F8 and E7, respectively), are conserved, and apparently those critical to the tertiary structure are conserved as well, for the **myoglobin** and **hemoglobin** chains have very similar tertiary structures.

Chain Interactions - In hemoglobin, the closest and strongest contacts appear to be between α and β chains, rather than $\alpha - \alpha$ or $\beta - \beta$. [Figure 7.3](#) also shows that the **heme** groups, with their O₂ binding sites, are all close to the surface but not close to one another. Therefore, we cannot seek the source of cooperative binding in anything so unsubtle as direct heme-heme interaction.

Changes on Binding Oxygen - A key to what is happening during oxygenation of hemoglobin can be seen in [Figure 7.12](#). What occurs is mostly a change in the quaternary structure, accompanied by much smaller tertiary structure changes. One α/β pair rotates and slides with respect to the other, bringing the β chains closer together and narrowing a central cavity in the molecule ([Figure 7.12b](#)). To a first approximation, the hemoglobin molecule has two states of quaternary structure, one characteristic of the deoxy form and the other favored by the oxy form. The oxy structure has the higher affinity for O₂, and the switch to this state is what accounts for the cooperativity in binding.

Relation to Hill Plot - The Hill plot ([Figure 7.9](#)) can be explained in terms of an allosteric shift between two molecular conformations. Wholly deoxygenated hemoglobin molecules are in the deoxy conformation, so addition of oxygen to a solution of such molecules starts the binding along the line corresponding to the weak-binding state. Partial oxygenation favors transition to the strong-binding oxy state. As oxygen is bound, more and more of the remaining available sites are in hemoglobin molecules that have this conformation. Therefore, the binding curve passes over to that for the strong-binding state.

See also: [Hill Plots and Cooperativity](#), [Models of Allosteric Activity](#), [Oxygen Binding by Hemoglobin](#)

INTERNET LINK: [Hemoglobin Allostery](#)

Figure 7.11: Comparison of sequences of myoglobin and the α and β chains of hemoglobin.



	Myo	Hb α	Hb β		Myo	Hb α	Hb β		Myo	Hb α	Hb β
1	VVV				52	EP-			103	YNN	
	-H-					AD-				LFF	
	LLL					EA-				ERK	
	STS					MV-				FLL	
	EPP					KM-				ILL	
	GEA					AGG				SGS	
	EED					SNS				ENH	
	WKK					EPA				AVC	
	QST					DKQ				ILL	
	LAN					LVV				IVL	
	VVV					KKK				HCV	
	LTK					KAG				VVT	
	HAA					HHH	E7			LLL	
	VLA					GGG				HAA	
	WWW					VKK				SHA	
	AGG					TKK				RHH	
	KKK					VVV				HFL	
	VVV					LLA			120	PGP	
	E-G					TGD				GKA	
	A-A					AAA				DEE	
	DNH					LFL				FFF	
	VVA					GST				GTT	
	ADG					ADN				APP	
	GEE					IGA				DPA	
	HVY					LLV				AVV	
	GGG					KAA				QQH	
	QGA					KHH				GAA	
	DEE					KLV				AAS	
	IAA				80	GDD				MYL	
	LLL					HND				NQD	
	IGG					HLM				KKK	
	RRR					EKP				AVF	
	LLM					AGN				LVL	
	FLF					ETA				EAA	
	KVL					LFL				LGS	
	SVS					KAS				FVV	
	HYF					PTA				RAS	
	PPP					LLL				KNT	
	EWT					ASS				DAV	
	TTT					QED				ILL	
40	LQK					SLL				AAT	
	ERT					HHH	F8			AHS	
	KFY					ACA				KKK	
	FFF					TDH				YYY	
	DEP					KKK				KHR	
	RSH					HLL				E	
	FFF					KHR				L	
	KG-					IVV	FG5			G	
	HDD					PDD				Y	
	LLL					IPP				Q	

FG corner



RSH
FFF
KG-
HDD
LLL
KSS
TTH

FG cc
HLL
KHR
IVV **FG5**
PDD
IPP
KEV

153

E
L
G
Y
Q
G

Figure 7.9: Hill plots of oxygen binding for myoglobin and hemoglobin.

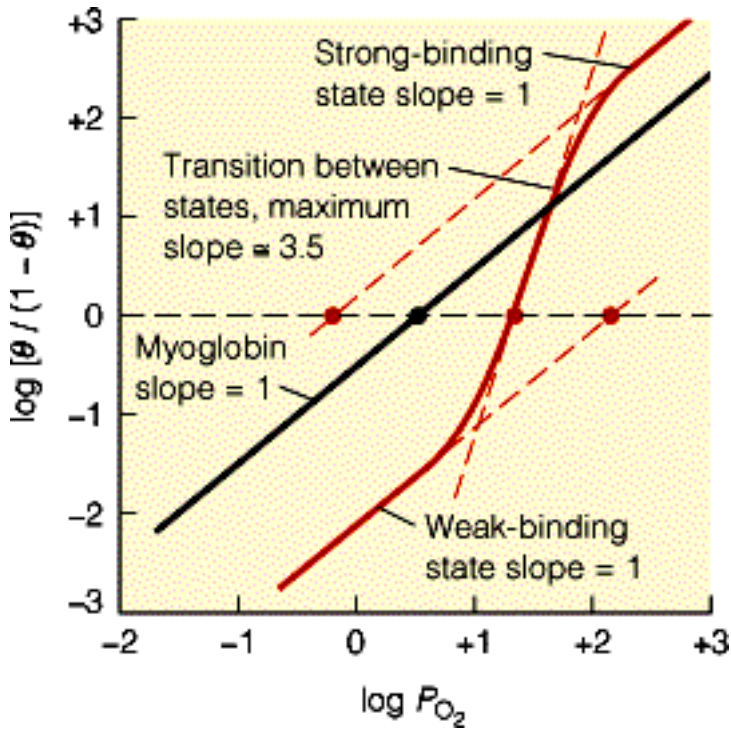

Interpretation: Wholly deoxygenated hemoglobin molecules are in the deoxy conformation, so as oxygen is added to a solution of such molecules, the binding initially occurs along the line corresponding to the weak-binding state. But partial oxygenation favors transition to the strong-binding oxy state. As oxygen is bound, more and more of the remaining available sites are in hemoglobin molecules that have this conformation. Therefore, the binding curve passes over to that for the strong-binding state. As the last few sites are filled, all the molecules have adopted the strong-binding form.

Hill Plots and Cooperativity

Derivation - Cooperativity results from a conformational "switch" from a weak-binding state to a strong-binding state. This switching is not easily visualized when binding curves are represented as in [Figure 7.8c or d](#), nor do such curves give an easy way to measure the degree of cooperativity. Rearranging [Equation 7.6](#), yields

$$\theta / (1 - \theta) = PO_2 / P_{50},$$

where θ is the fraction of oxygen-binding sites that are occupied, PO_2 is the partial pressure of oxygen, and P_{50} is the oxygen partial pressure for half-saturation.

Taking logarithms of both sides,

$$\log \frac{\theta}{1 - \theta} = \log P_{O_2} - \log P_{50} \quad (7.9)$$

Graphing $\log [\theta / (1 - \theta)]$ versus $\log PO_2$ produces what is called a **Hill plot** ([Figure 7.9](#)). The **Hill plot** for noncooperative binding will, according to equation (7.9), be a straight line with slope = 1. In such a plot, the abscissa value (the value of $\log PO_2$) corresponding to $\log [\theta / (1 - \theta)] = 0$ will equal $\log P_{50}$. When [hemoglobin](#) first begins binding (at low PO_2), its **Hill plot** has a slope >1 , corresponding to the weak-binding state (large P_{50}). As binding progresses, the curve switches over to approach another, parallel line that describes the strong-binding state (small P_{50}).

Advantages of Hill Plots - **Hill plots** readily identify the transition between binding states in cooperativity, and the binding behavior is unmistakably different for cooperative and noncooperative systems. Furthermore, the **Hill plot** gives a direct numerical measure of the degree of cooperativity from its maximum slope, n_H , which is called the Hill coefficient.

Interpreting Plots - Three cases may be considered for a molecule with n binding sites:

1. $n_H = 1$: The molecule binds noncooperatively. This situation can happen even with a multisite protein if the sites do not communicate with one another.
2. $1 < n_H < n$: This situation is the usual one for a cooperatively binding protein, as depicted in [Figure 7.9](#). The Hill coefficient must be greater than unity in order for the Hill plot to switch over from the weak-binding line to the strong-binding line.

3. $n_H = n$: In this hypothetical situation the molecule is wholly cooperative. In such a situation, one hemoglobin molecule would fill up its four oxygen-binding sites before any others had taken oxygen, so that only wholly unliganded and wholly liganded molecules would be present at any point in the binding process. If this were the case, the binding curve would have the form

$$\theta = \frac{P_{O_2}^n}{P_{50}^n + P_{O_2}^n} \quad (7.10)$$

and the Hill equation would become

$$\log \frac{\theta}{1 - \theta} = n \log P_{O_2} - n \log P_{50} \quad (7.11)$$

which is a straight line with slope = n . This case is never seen in reality. For example, the Hill coefficient of hemoglobin ($n = 4$) never exceeds about 3.5.

Allosteric Effects - The cooperative binding of oxygen by hemoglobin is one example of what is referred to as **allosteric effects**. In **allosteric** binding, the uptake of one ligand by a protein influences the affinities of remaining unfilled binding sites. The ligands may be of the same kind (as in hemoglobin), or they may be different as in the way binding of [2,3-bisphosphoglycerate](#) to hemoglobin affects the protein's affinity for oxygen (see [here](#)). **Allostery** is also an important mechanism for regulating the activity of enzymes. For example, both the enzymatic activity and the substrate preferences of the nucleotide metabolism enzyme, [ribonucleotide reductase](#), are controlled by small effector molecules, such as [ATP](#) (see [here](#)). In that case, **allostery** allows one kind of small molecule to regulate the action of a protein on another kind of molecule. The ability of multisubunit proteins to be regulated **allosterically** may be one of the reasons these proteins are so common.

See also: [Oxygen Binding by Hemoglobin](#), [Oxygen Binding by Myoglobin](#), [Hemoglobin Allostery](#), [Oxygen Binding by Heme Proteins](#), [Bisphosphoglycerate and Hemoglobin](#), [Regulation of Ribonucleotide Reductase](#) (from Chapter 22)

Figure 7.8: The binding curve required for a transport protein.

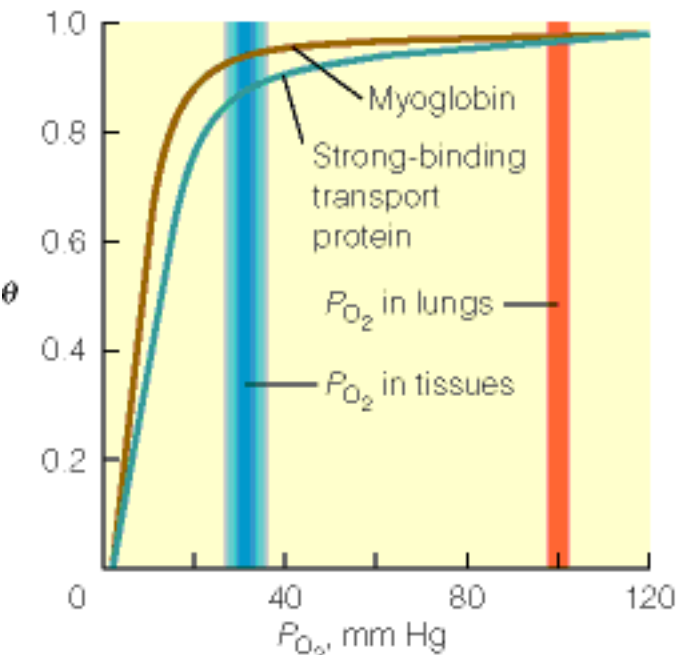

(a) Transport protein efficient in binding but inefficient in unloading (hyperbolic binding curves)

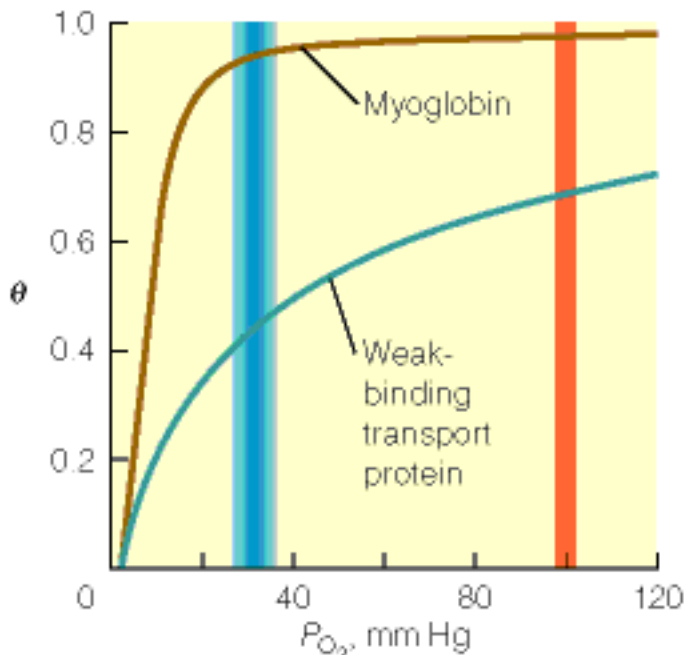

(b) Transport protein efficient in unloading but inefficient in binding (hyperbolic binding curves)

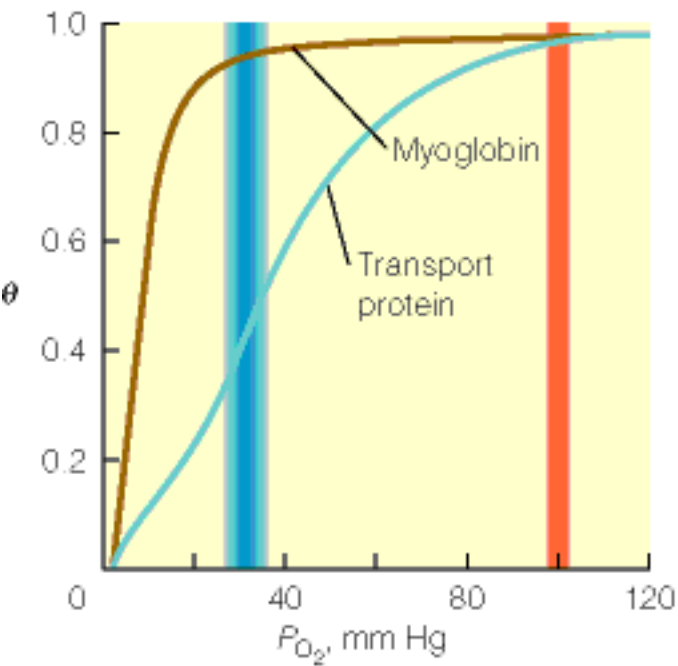

(c) Transport protein efficient in both binding and unloading, because it has a sigmoidal binding curve.

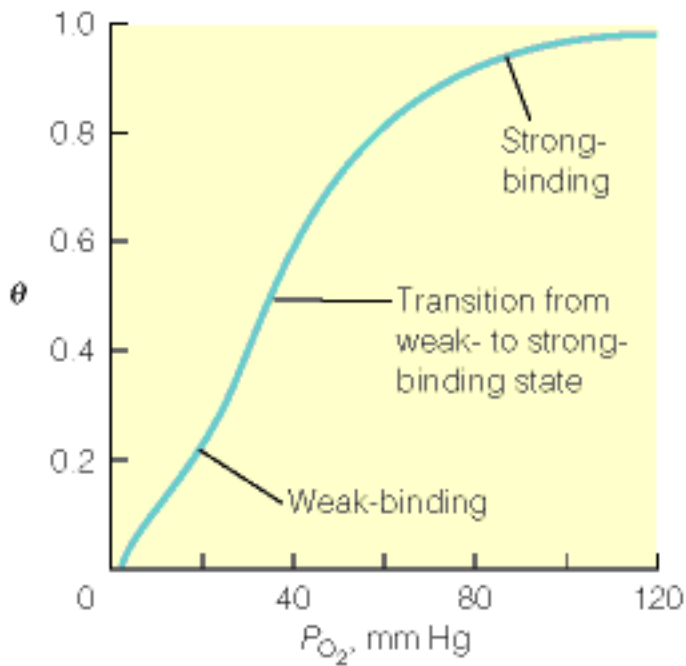

(d) Switch from weak- to strong-binding state explains the sigmoidal curve

Equation 7.6



$$\theta = \frac{P_{O_2}}{P_{50} + P_{O_2}} \quad (7.6)$$

Regulation of Ribonucleotide Reductase

Regulation of both the activity and the specificity of [ribonucleotide reductase](#) is essential to maintain balanced quantities of DNA precursors. The large R1 subunit contains two classes of regulatory sites (two of each site per molecule in the *E. coli* enzyme).

Activity Sites - These bind either [ATP](#) or [dATP](#) with relatively low affinity.

Specificity Sites - These bind [ATP](#), [dATP](#), [dGTP](#), or [dTTP](#) with relatively high affinity.

The binding of ATP at the activity sites enhances the catalytic efficiency of the enzyme for all substrates, whereas dATP binding at the activity sites acts as a general inhibitor of all four reactions.

Binding of nucleotides at the specificity sites modulates the activities of the enzyme toward different substrates, so as to maintain balanced rates of production of the four dNTPs. [Table 22.2](#) summarizes the complex regulatory effects of binding at both the activity and specificity binding sites.

Mutations in **ribonucleotide reductase** that affect either the activity or specificity sites can render the enzyme less susceptible to inhibition by dNTP effectors. Cells carrying these kinds of mutations display both abnormalities in the quantities of dNTPs they contain and so-called [mutator phenotypes](#). That is, cells with mutator phenotypes show increased rates of spontaneous mutation at all genetic loci tested. These findings suggest that when dNTP concentrations are altered at DNA replication sites, the likelihood is increased for replication errors, which lead to mutations.

See also: [Ribonucleotide Reductase and Deoxyribonucleotide Biosynthesis](#), [DNA Replication Overview](#) (from Chapter 24), [Adenosine Deaminase](#)

INTERNET LINK: [Mutation](#)

Deoxyguanosine Triphosphate (dGTP)

dGTP

is a

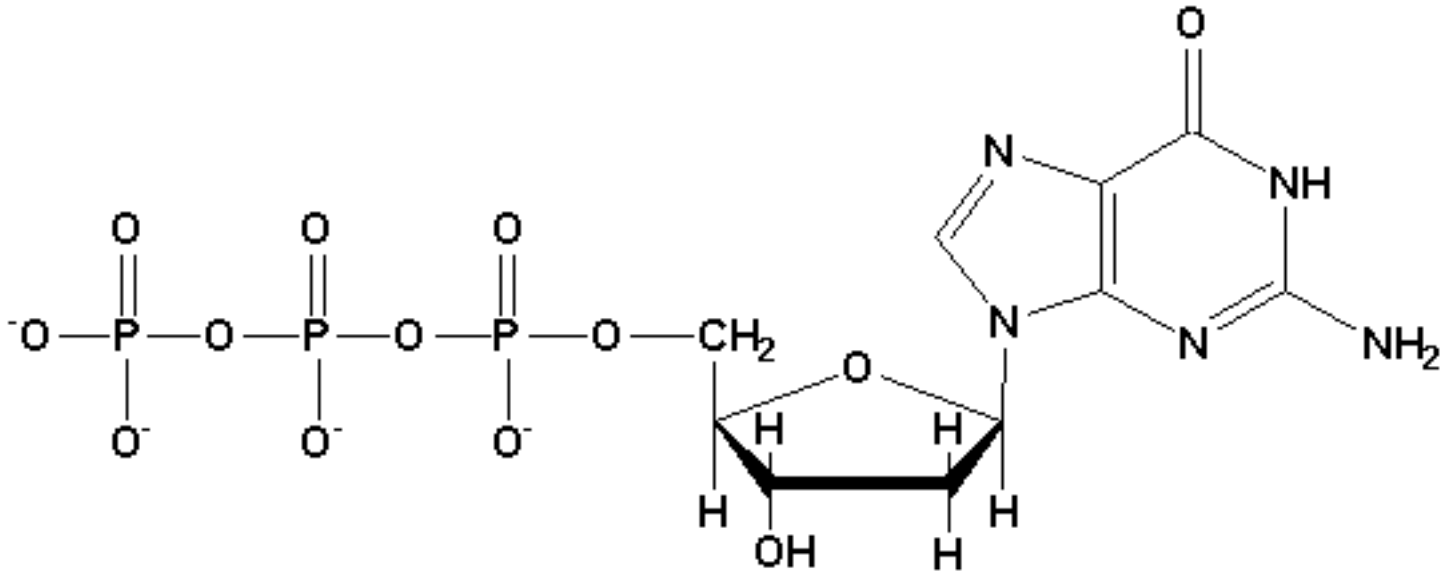

Deoxyguanosine triphosphate (dGTP)

substrate for DNA polymerase in synthesis of DNA. It is produced from dGDP by nucleoside diphosphokinase catalysis as follows:

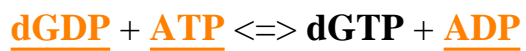

See also: Nucleotides

Deoxyguanosine Diphosphate (dGDP)

dGDP is a deoxyribonucleotide made from GDP in the reaction catalyzed by **ribonucleotide reductase**, as follows:

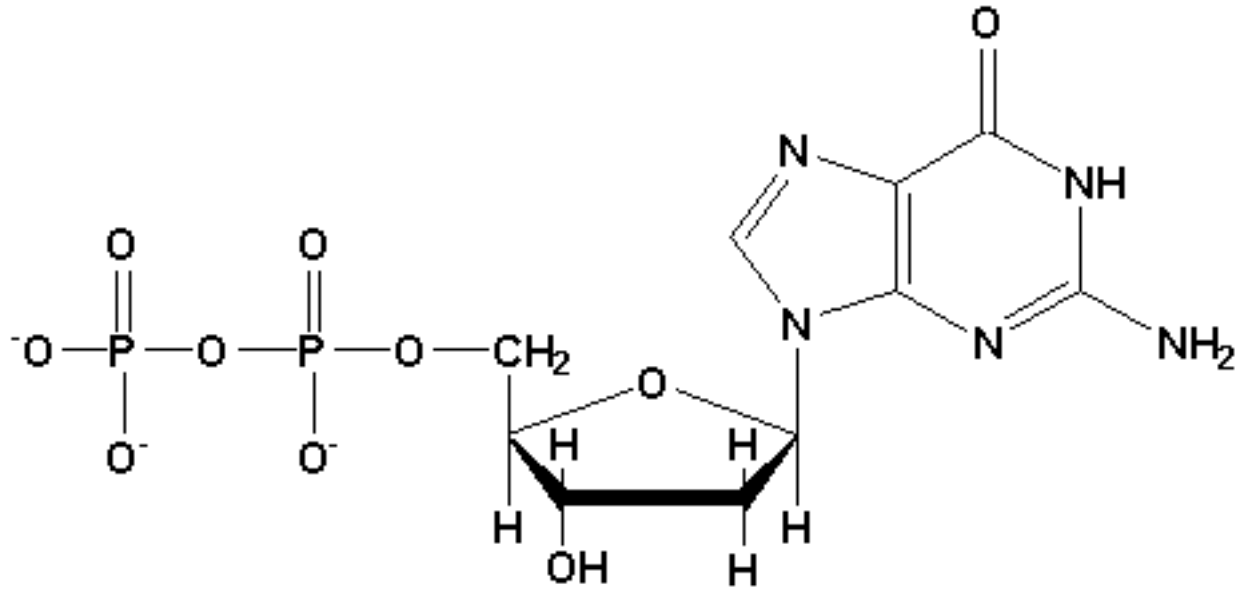

Deoxyguanosine diphosphate (dGDP)

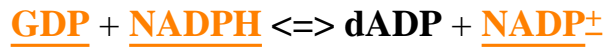

Phosphorylation of **dGDP** yields **dGTP**, a substrate for DNA polymerase in synthesis of **DNA**.

See also: [Nucleotides](#)

Table 22.2



Nucleotide Bound in			
Activity Site	Specificity Site	Activates Reduction of	Inhibits Reduction of
ATP	ATP or dATP	CDP, UDP	
ATP	dTTP	GDP	CDP, UDP
ATP	dGTP	ADP	CDP, UDP ^a
dATP	Any effector		ADP, GDP, CDP, UDP

^adGTP binding inhibits the reduction of pyrimidine nucleotides by the mammalian enzyme but not by the *E. coli* enzyme.

Terminology



De novo Pathway - A term used to describe biochemical synthetic reactions where products are made completely from raw materials, as opposed to the situation where products are made by "rebuilding" a substrate resulting from breakdown of the product. The latter are called salvage pathways. [Figure 22.1.](#)

HAT Medium - A cell culture medium augmented by hypoxanthine, aminopterin, and thymidine, which selects for cells that have a functional purine salvage pathway.

Hyperuricemia - A condition in about 0.3% of the human population involving chronic elevation of blood uric acid levels, well beyond normal limits.

Mutator Phenotypes - Cell lines that show increased rates of spontaneous mutation at all genetic loci tested.

Nucleoside - A molecule that, upon complete hydrolysis, yields at least 1 mole per mole of a purine or pyrimidine base and a sugar.

Nucleoside Diphosphate - A nucleoside with two phosphates attached to it.

Nucleoside Monophosphate - A nucleoside with one phosphate attached to it.

Nucleoside Triphosphate - A nucleoside with three phosphates attached to it.

Nucleotide - A molecule that, upon complete hydrolysis, yields at least 1 mole per mole of a purine or pyrimidine base, a sugar, and inorganic phosphate.

purR - An *E. coli* repressor protein controlling expression of genes in de novo purine biosynthesis. It binds either hypoxanthine or guanine. The resulting complex binds to DNA sites near several genes of purine (and pyrimidine) synthesis, inhibiting their transcription.

Salvage Pathway - A term used to describe biochemical synthetic reactions where products are made by rebuilding a substrate resulting from breakdown of the product (or a related product).

Synchronizing Cell Cultures - Laboratory procedure of manipulating cells to bring all of them to the same phase of the cell cycle. It is accomplished by a thymidine block.

Thymidine Block - Mechanism for synchronizing cells in which thymidine is added to cells to inhibit DNA synthesis. This prevents passage of the cells from the G1 to S phase of the cell cycle. Subsequent transfer of cells to a medium lacking thymidine reverses the inhibition and allows them to initiate DNA synthesis synchronously.

The Immune Response

When a foreign substance - a virus, a bacterium, or even a foreign protein-invades the tissues of a higher vertebrate (like a human), the organism defends itself by what is called the **immune response**. The **immune response** is a first line of defense against infection and probably against cancer cells as well. Crippling of the immune system by the HIV virus makes AIDS (acquired immune deficiency syndrome) a disease that has so far proved to be almost invariably fatal. The **immune response** has two facets:

1. **Humoral immune response** - Lymphatic cells called B lymphocytes synthesize specific immunoglobulin molecules that are excreted from the cell and bind to the invading substance. Binding either precipitates the foreign substance or marks it for destruction by cells called macrophages.

2. **Cellular immune response** - Lymphatic cells called T lymphocytes, bearing immunoglobulin-like molecules on their surfaces, recognize and kill foreign or aberrant cells.

Antigens and Antibodies - The foreign substance that elicits an **immune response** is called the **antigen**. A specific immunoglobulin that binds to the antigen is called the **antibody**. If the invading particle is large, like a cell, a virus, or a protein, many different **antibodies** may be elicited, each type binding specifically to an **antigenic** determinant (or **epitope**) on the surface of the particle ([Figure 7.29a](#)).

The **immune response** is incredibly versatile:

1. It can respond to an enormous number of different foreign substances.
2. The immune response has a so-called memory: After an initial exposure to a given antigen, a second exposure at a later date results in rapid and much more massive production of the antibodies specific to the antigen.

Clonal Selection Theory - The **clonal selection theory** explains how the body has an inherent ability to produce an immense diversity of antibodies with different amino acid sequences that are able to bind an enormous range of antigens. The basic postulates are illustrated in [Figure 7.30](#).

See also: [Clonal Selection Theory](#), [Antibody Structure](#), [Generation of Antibody Diversity](#), [Antibody Diversity](#) (from Chapter 25) [T Cells and the Cellular Response](#), [AIDS and the Immune Response](#)

INTERNET LINKS:

- 1. [The Latest in Antibody News](#)**
 - 2. [Antibody Resource Page](#)**
-

Figure 7.29: Antigenic determinants.

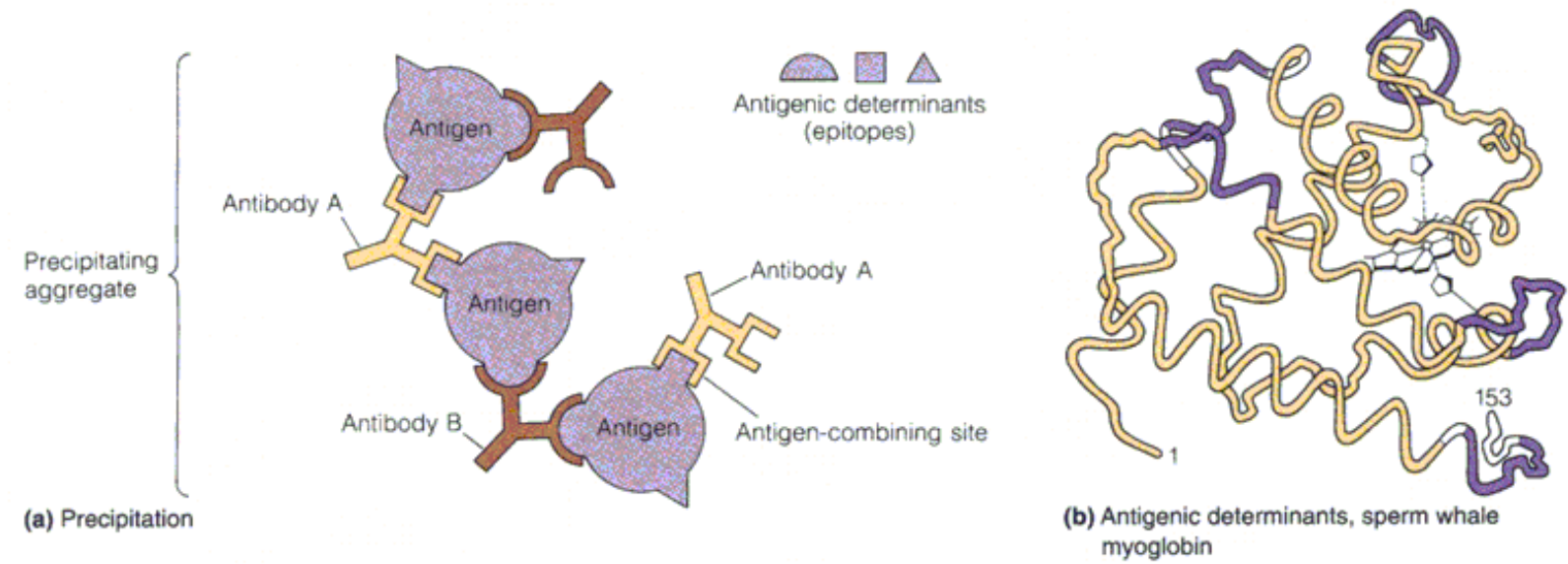

(b) M. Z. Atassi, *Immunochem.* (1975) 12:435. © 1975 with permission of Elsevier Science.

Figure 7.30: The clonal selection theory of the immune response.

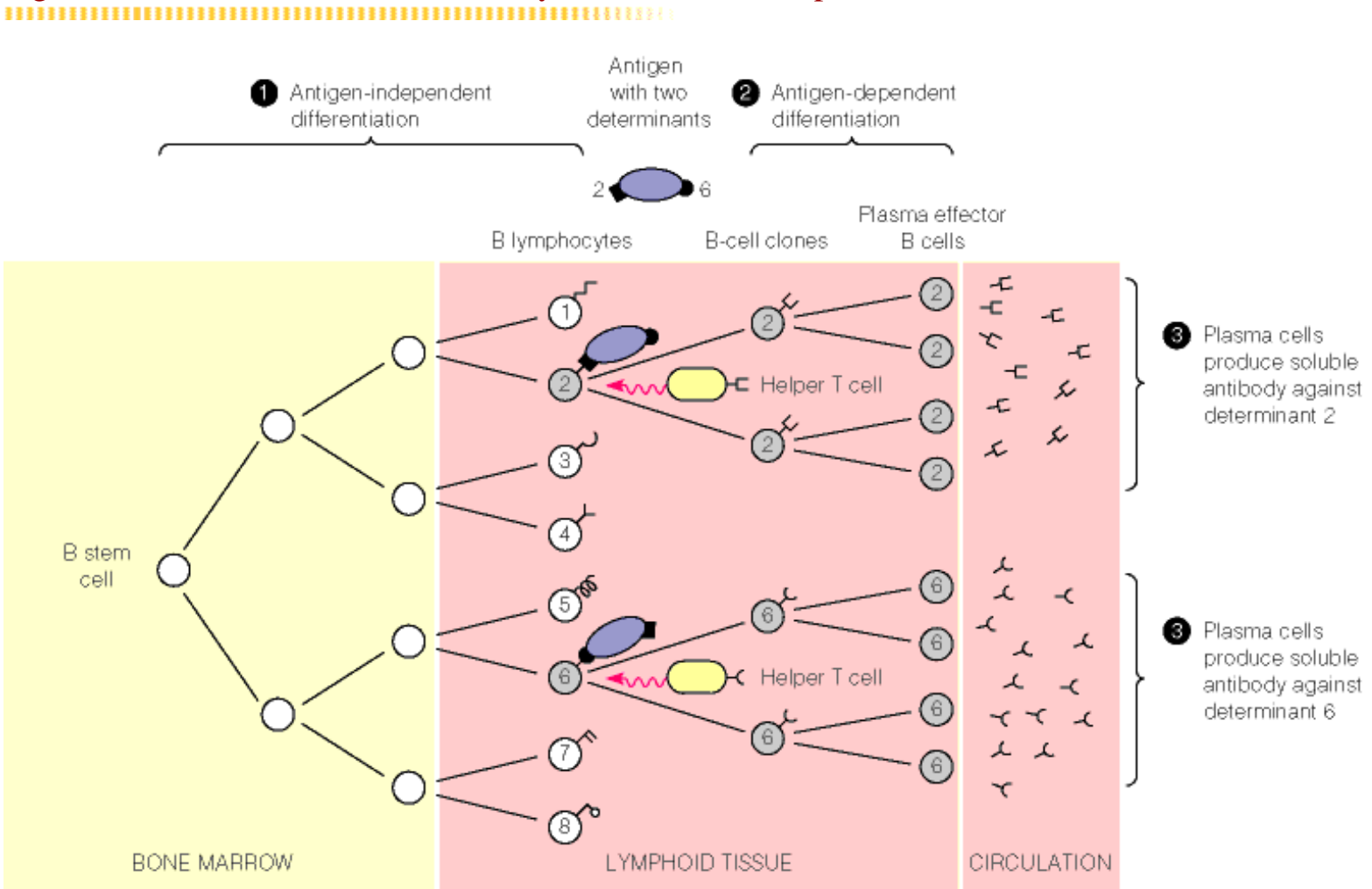

Adapted with permission from J. Darnell, H. Lodish, and D. Baltimore, Molecular Cell Biology; ©1986 Scientific American Books, Inc.

Clonal Selection Theory



Antibody Diversity - The **clonal selection theory** explains how the body has an inherent ability to produce an immense diversity of antibodies with different amino acid sequences that are able to bind an enormous range of antigens. The basic postulates, illustrated in [Figure 7.30](#), are the following:

1. B stem cells in the bone marrow differentiate to become B lymphocytes, each producing a slightly different type of immunoglobulin molecule, each type with a binding site that will recognize specific molecular shapes. These immunoglobulins, or antibodies, are attached to the cell membrane and exposed on the outer surfaces of the B lymphocytes.
2. Binding of an antigen to one of these antibodies stimulates the cell carrying it to replicate, generating a clone (a collection of cells with identical genetic information). This primary response is aided by a special class of T cells called helper T cells. If a helper T cell recognizes a bound antigen, it binds to the appropriate B lymphocyte and transmits to it a signal protein (interleukin-2) that stimulates B-cell reproduction. Thus, those clones of B cells that recognize antigens are stimulated to continued cell division.
3. Two classes of cloned B cells are produced ([Figure 7.30](#) and [Figure 7.31](#)). Effector B cells, or plasma cells, produce soluble antibodies, which are excreted into the circulatory system. These antibodies have the same antigen binding sites as the surface antibodies of the B lymphocyte from which the effector cells arose, but they lack the hydrophobic tail that bound the surface antibodies to the lymphocyte membrane. The other class of cells in the clone-memory cells - will persist for some time, even after antigen is no longer present. This persistence constitutes the immune memory. That is it allows a rapid secondary response to a second stimulation by the same antigen, as shown in [Figure 7.31](#).

Lack of Immunity to Self - We do not find clones producing antibodies against our own proteins and tissues because when immature B cells in the fetus encounter substances that bind to their surface antibodies, they are not stimulated to replicate. Rather, these cells are destroyed. Thus, cells producing antibodies against all of the potential "self" antigens to which we might react are eliminated before birth. The only B cells that mature are those that produce antibodies against "nonself" substances.

Autoimmunity - Occasionally, the immune system goes awry and produces antibodies against the normal tissues of an adult. The reasons for such autoimmunity are not wholly understood, but the resulting diseases can be devastating. In lupus erythematosus, for example, the individual's own [nucleic acids](#) become the object of attack.

See also: [The Immune Response](#), [Antibody Structure](#), [Generation of Antibody Diversity](#), [T Cells and the Cellular Response](#), [Interleukin-2](#)

Figure 7.31: Two developmental paths for stimulated B lymphocytes.

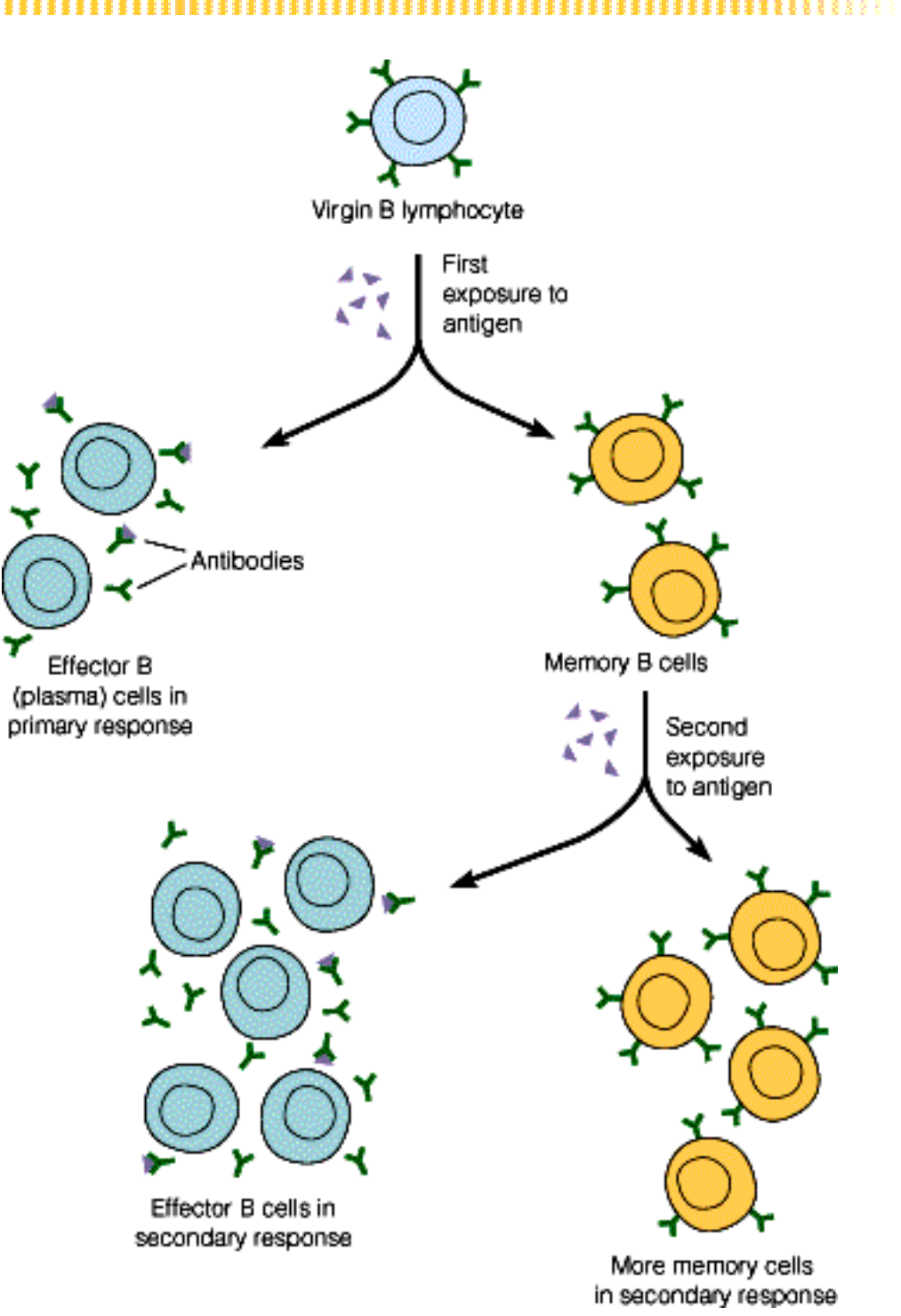

Antibody Structure

Immunoglobulin Molecules - There are five classes of immunoglobulin molecules, which carry out various functions in the immune system ([Table 7.3](#)). All are built from the same basic immunoglobulin pattern ([Figure 7.32](#)). Different kinds of antibodies may contain from one to five immunoglobulin molecules. When more than one is present, the monomers are linked by a second type of polypeptide, called a J chain (see [Table 7.3](#)).

Immunoglobulin Structure - Each immunoglobulin monomer consists of four chains, two heavy chains (M = 53,000 each) and two light chains (M = 23,000 each), held together by disulfide bonds. In each chain are constant domains (identical in all antibodies of a given class) and a variable domain ([Figure 7.33](#)). Variations in the amino acid sequence (and therefore the tertiary structure) of the variable domains of the light and heavy chains confer the multitudinous specificities of antigens to different determinants.

Precipitating Antigens - A large protein, a virus, or a bacterial cell has many different potential antigenic determinants on its surface that antibody molecules can bind, thereby precipitating the antigen (see [Figure 7.29a](#)). Antigens with only one determinant, will bind to an antibody, but not precipitate. Precipitation also requires the antibody to be bivalent (to have two binding sites). By careful proteolysis, it is possible to cleave antibodies at the hinge region (see [Figure 7.32](#)) to produce Fab fragments with only one binding site each. Such fragments will bind, but not precipitate antigen.

Antigen Binding Sites - The antigen binding site lies at the extreme end of the variable domains and involves amino acid residues from the variable regions of both heavy and light chains. The antigen and antibody surfaces fit together in a highly complementary fashion.

Signaling Macrophages - The constant domains of the heavy chains in the base of the Y-shaped immunoglobulin molecule hold the chains together and function as effectors, to signal macrophages in the circulatory system to attack particles or cells that have been labeled by antibody binding. Macrophages are large white blood cells that are specially adapted to engulf and digest foreign particles. Differences in heavy chains identify immunoglobulin types for delivery to different tissues or for secretion (see [Table 7.3](#)).

See also: [The Immune Response](#), [Generation of Antibody Diversity](#), [Immunoglobulins](#), [Antigens](#)

INTERNET LINKS:

1. [The Latest in Antibody News](#)

2. [Antibody Resource Page](#)

Table 7.3

IgM is produced during the early response to an invading microorganism. It is the largest immunoglobulin, containing five Y-shaped units of two light and two heavy chains each. The units are held together by a component called a J chain. The relatively large size of IgM restricts it to the bloodstream. It is also effective in triggering an important mechanism for foreign cell destruction, called the complement system.

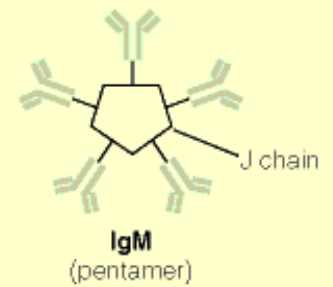

IgG molecules, also known as γ -globulin, are the most abundant of circulating antibodies. A variant is attached to B-cell surfaces. IgG molecules consist of a single Y-shaped unit and can traverse blood vessel walls rather readily; they also cross the placenta to carry some of the mother's immune protection to the developing fetus. Specific receptors allow such passage. IgG also triggers the complement system.



IgA is found in body secretions, including saliva, sweat, and tears, and along the walls of the intestines. It is the major antibody of colostrum, the initial secretion from a mother's breasts after birth, and of milk. IgA occurs as a monomer or as double-unit aggregates of the Y-shaped protein molecule. IgA molecules tend to be arranged along the surface of body cells and to combine there with antigens, such as those on a bacterium, thus preventing the foreign substance from directly attaching to the body cell. The invading substance can then be swept out of the body together with the IgA molecule.

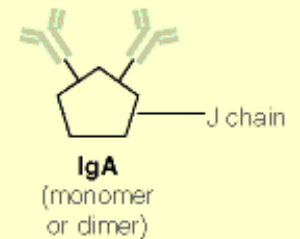

Less is known about the IgD and IgE immunoglobulins. IgD molecules are found on the surface of B cells, though little is known about their function. IgE is associated with some of the body's allergic responses, and its levels are elevated in individuals who have allergies. The constant regions of IgE molecules can bind tightly to mast cells, a type of epithelial and connective tissue cell that releases histamines as part of the allergic response. Both IgD and IgE consist of single Y-shaped units.

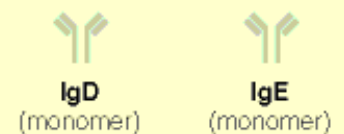

Figure 7.32: Schematic models of an antibody molecule and a Fab fragment.

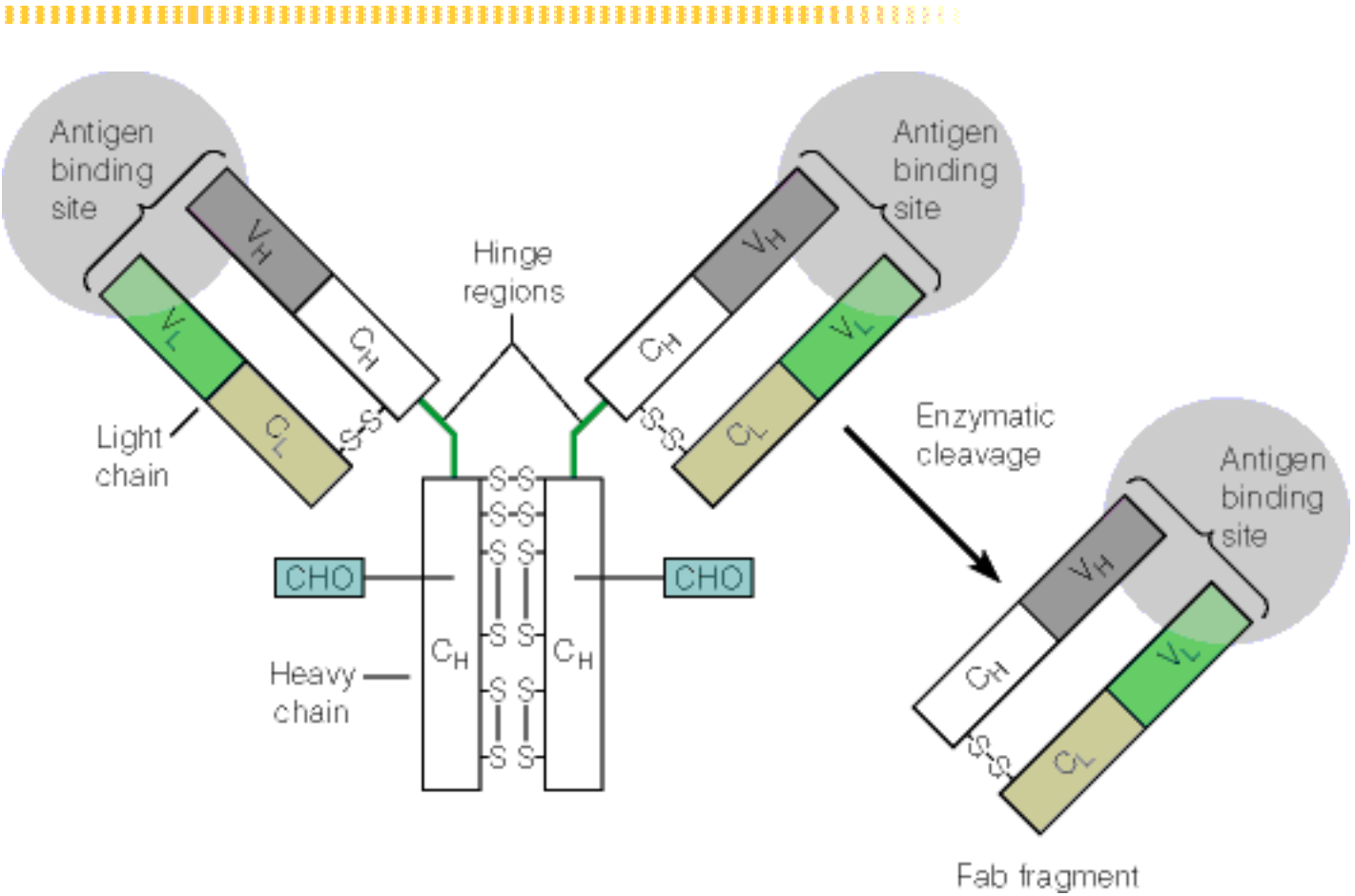
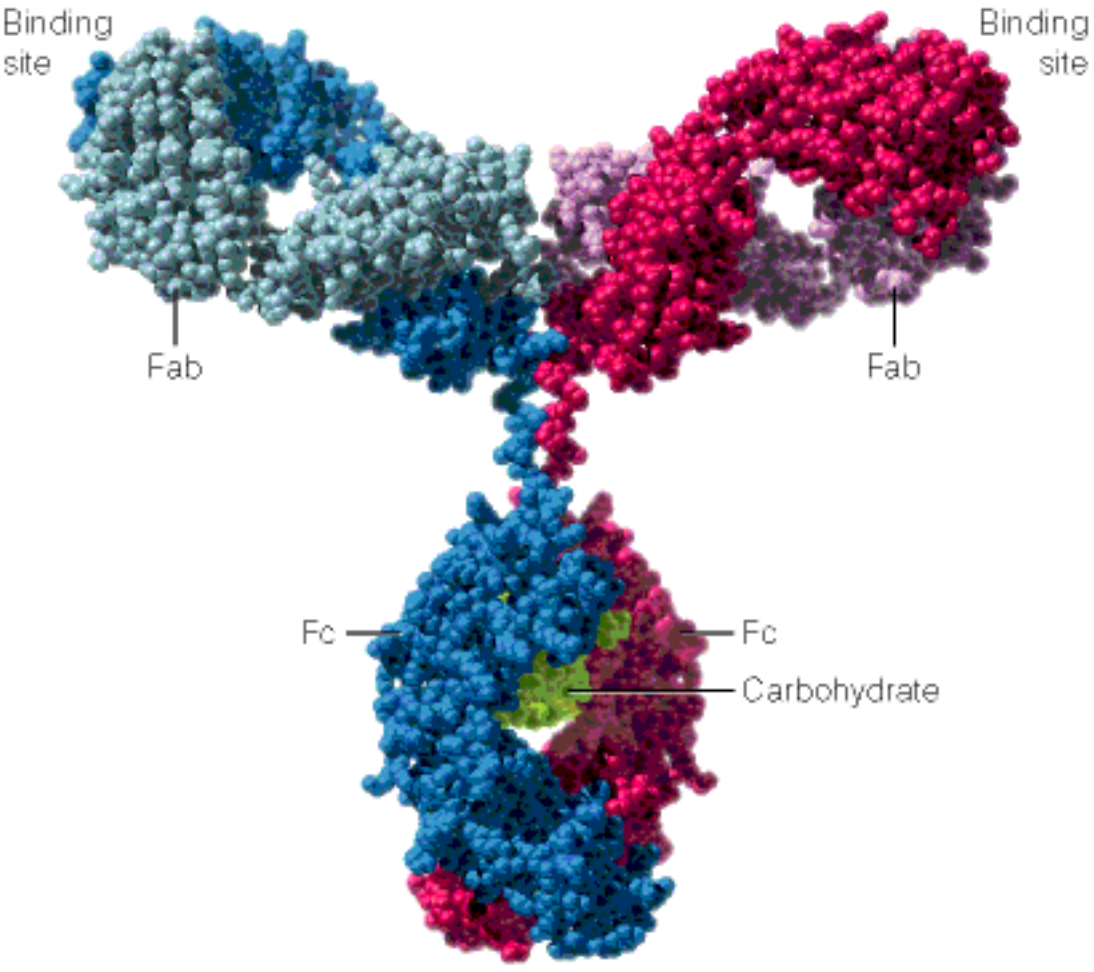

Figure 7.33: A model of the IgG molecule from x-ray diffraction studies.



Adapted from E. A. Padlan, Mol. Immunol. (1994) 31:169-217. © 1975 with permission of Elsevier Science.

Generation of Antibody Diversity

Sequence Shuffling/Changes - The human genome simply does not have enough room to encode a separate gene for each of the millions of different immunoglobulin molecules occurring in B stem cells. Instead, the following two special processes occur in these cells.

1. **Recombination of Exons** - The major source of antibody diversity is recombination of exons. The genomes of higher vertebrates contain "libraries" of exons corresponding to different portions of the immunoglobulin molecule and mechanisms for rearranging these exons to create different combinations in both the heavy and light chains. Shuffling of these exons occurs in B cells and creates new immunoglobulins in individual cells. The details and mechanism of this process are described [here](#).

2. **Somatic Mutations** - An additional source of antibody diversity is somatic mutations (non-germline mutations). In the cells that generate antibodies, certain portions of the variable regions in the immunoglobulin genes mutate at an unusually high rate. The reason for these localized high rates of mutation is still obscure, but this process, together with recombination of gene fragments, can account for the generation of an immense diversity of immunoglobulin molecules. About 100 million combinations can theoretically be made from the library of immunoglobulin gene fragments available in the human genome.

See also: [Mechanisms of Protein Mutation](#), [Antibody Structure](#), [Clonal Selection Theory](#), [Gene Rearrangements](#) (from Chapter 25), [Generating Antibody Diversity](#) (from Chapter 25)

INTERNET LINKS:

1. [The Latest in Antibody News](#)
 2. [Antibody Resource Page](#)
-

Generating Antibody Diversity

Antibodies are proteins manufactured by vertebrate immune systems that aid in defense against infectious agents and other substances foreign to the animal. It is estimated that a human is capable of synthesizing more than 10 million distinct antibodies. Most of this great diversity is generated through the action of precisely controlled gene rearrangements which occur during differentiation of many individual clones of cells, each clone specialized for the synthesis of one and only one antibody. The immune response involves proliferation of clones of cells that produce antibodies reacting with a specific antigen, or immunogen. This clonal expansion allows large-scale production of the specific antibodies needed to combat infection or other challenges to the immune system.

The immunoglobulin G, or IgG, class of proteins consists of two heavy chains and two light chains (**Figure 25.32**). Each chain comprises two distinct segments--a domain of variable polypeptide sequences and a constant domain, which is virtually invariant among different IgG light or heavy chains.

Figure 25.32 shows the organization of the precursor genes to **K** chains in germ-line cells, undifferentiated for antibody formation, and the rearrangements leading to one such gene in a differentiated antibody-producing cell.

Each light chain is encoded by DNA sequences that are noncontiguous in the genome of undifferentiated cells but are all in the same chromosome. These sequences are called V (variable), C (constant), and J (joining). The human genome contains about 300 different V sequences, each of which encodes the first 95 amino acids of the variable region; 4 different J sequences, each of which encodes the last 12 residues of the variable region and joins it to the constant region; and one C sequence, which encodes the constant region. In an embryonic cell the V sequences, each preceded by a leader sequence containing a transcriptional activator that is not expressed, form a tight cluster; the J sequences form another cluster some distance away; and the C sequence follows shortly after the J cluster. Each J sequence is flanked by nonexpressed spacer sequences.

In differentiation of one antibody-forming clone of cells, a gene rearrangement links one of the approximately 300 V sequences with one of the 4 J sequences. All of the DNA that lies between these two spliced sequences is deleted in this rearrangement and disappears from all progeny of this cell line. Any upstream V sequences (on the 5' side, to the left in **Figure 25.32**) and downstream J sequences (on the 3' side, to the right) remain in these cells but are not used in antibody synthesis.

Additional diversity is provided by the way in which the V and J sequences recombine. The cutting and splicing can occur within the terminal trinucleotide sequences of V and J in any way that yields one trinucleotide sequence in the spliced product (**Figure 25.33**). This increases the total number of different light chain sequences by about 2.5 (the average number of different amino acids encoded by four random triplets). Thus, the total number of possible light chain sequences that can be formed from 300 V sequences and 4 J sequences is about 3000 (300 X 4 X 2.5).

Related DNA sequences are found to the 3' side of each V sequence and to the 5' side of each J sequence, and they represent recognition sites for the enzymes involved in the joining reaction. Those sequences, which are called recognition signal sequences, are as follows:

$$5' \dots V \dots \text{CACAGTG} \dots 12 \text{ bases} \dots \text{ACAAAAAC} \dots 3'$$
$$3' \dots J \dots \text{GTGTCAC} \dots 23 \text{ bases} \dots \text{TGTTTTTG} \dots 5'$$

Note the presence of nearly identical seven-base palindromic sequences and nearly complementary eight-base AT-rich regions in these segments. These features allow the alignment of distant regions of the chromosome, with a process akin to that in phage λ integration, recombining the sequences and excising the intervening DNA. In addition, the DNA joining reactions are imprecise, with nucleotides removed from one or both ends, creating additional diversity.

The final step in producing a light chain polypeptide involves the joining of the C and J segments (see [Figure 25.32](#)). This occurs not at the DNA level but at the level of splicing of messenger RNA (see [here](#)). In this case, transcription yields an RNA molecule extending from the 5' side of the V gene that is spliced to J to the 3' side of C. Depending on which J region has been spliced to V in this cell, the RNA excised during splicing may contain sequences corresponding to other J regions.

Heavy chains are formed similarly—from V sequences, J sequences, and a class of sequences called D. In addition, there are eight different C sequences, which are also involved in the synthesis of other antibody classes. The total number of possible IgG heavy chains is about 5000. Because any light chain can combine with any heavy chain to form a complete IgG, the total number of IgG molecules possible is 3000×5000 , or 1.5×10^7 . In this way, enormous diversity can be generated from a very small fraction of the total DNA in germ-line cells. Even further diversity arises from the high rate of V sequence mutation during development of the antibody-producing cell. By this somatic mutation process (mutation not involving germ-line cells), cells that undergo the same V-J joining event may still differentiate to produce different IgGs.

It is not clear whether both of the homologous chromosomes in a diploid antibody-forming cell undergo identical rearrangements. However, given that each cell produces only one type of antibody, that must occur or one chromosome must be silenced after the other has completed its rearrangement.

See also: [Gene Rearrangements](#), [Site-Specific Recombination](#), [Homologous Recombination](#), [Recombination](#), [Antibody Structure](#) (from Chapter 7), [The Immune Response](#) (from Chapter 7), [Generation of Antibody Diversity](#) (from Chapter 7)

INTERNET LINKS:

1. [The Latest in Antibody News](#)

2. [Antibody Resource Page](#)

Figure 25.32: Gene rearrangements in antibody gene maturation.

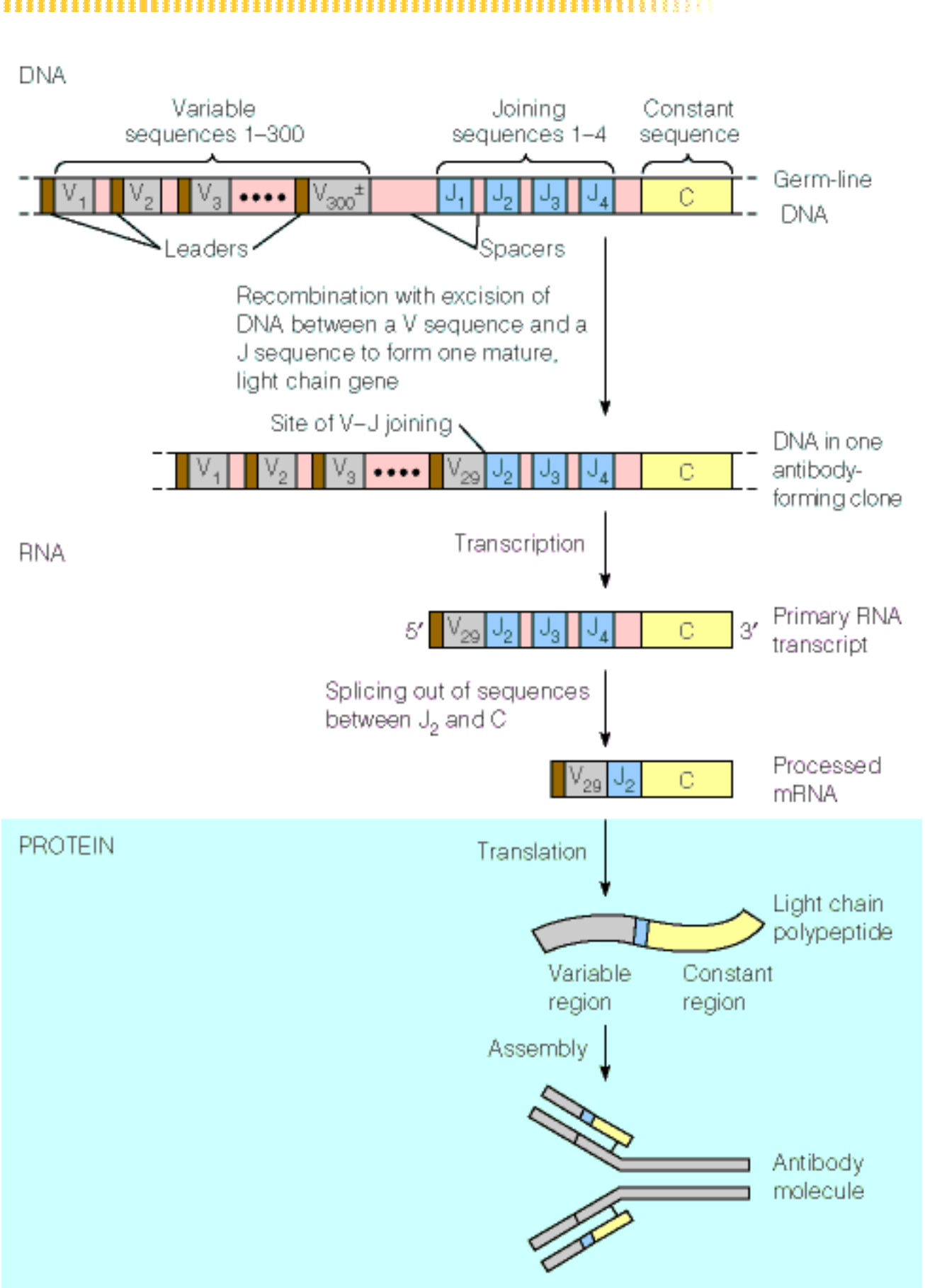
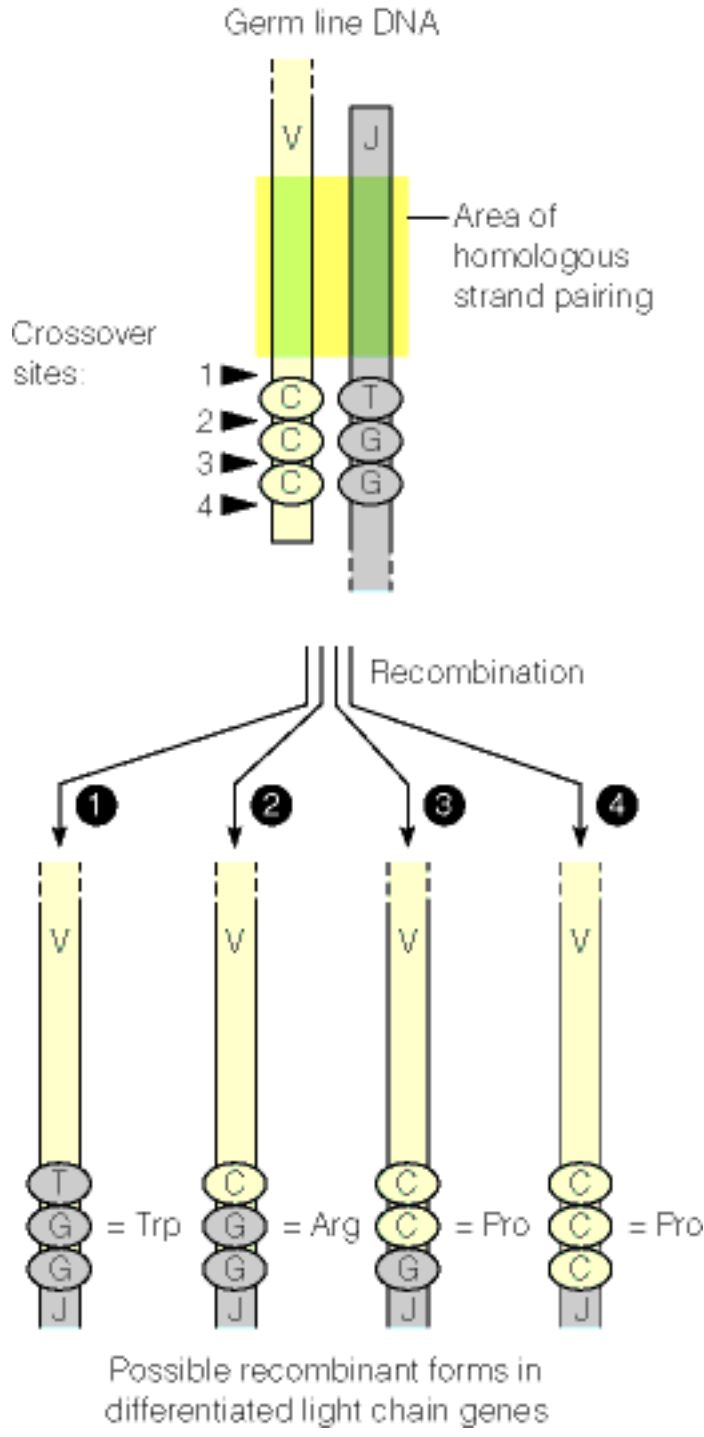

Figure 25.33: Generation of diversity by variable V-J joining mechanisms.



Gene Rearrangements



In normal eukaryotic development, segments of DNA can do the following:

1. Be deleted from the genome,
2. Move from one site to another within a genome, and
3. Duplicate themselves manyfold.

In addition, mobile genetic elements have been described in both prokaryotes and eukaryotes. These segments of DNA can move from one chromosomal integration site to another, apparently unrelated to developmental processes. These processes represent a specialized form of recombination.

Three widely studied aspects of genome plasticity include the following:

1. [Antibody variability in vertebrates](#)
2. [Gene transposition](#)
3. [Gene amplification](#).

See also: [Retrovirus Transposition](#), [Recombination](#)

Transposable Genetic Elements

Transposable genetic elements are DNA fragments containing genes that do not have a fixed location in a genome but can move from place to place within the genome, albeit with low frequency.

Transposition occurs without benefit of DNA sequence homology, but the enzymes catalyzing **transposition** recognize short sequences of about a half dozen nucleotides.

Transposable elements have been demonstrated in many eukaryotes, including maize, *Drosophila*, yeast, and bacteria. Gene transposition in eukaryotic systems presents some strong similarities to and some distinct differences from transposition in bacteria. The first major distinction is that integration and excision are distinct processes in eukaryotes. Thus, the **transposable element** can be isolated in free form, often as a double-strand circular DNA. Second, replication of that DNA often involves the synthesis of an RNA intermediate. Both of these properties are seen in the retroviruses of vertebrates, perhaps the most widely studied class of eukaryotic **transposable elements**.

There are several distinctions between bacterial **transposition** and other recombinational mechanisms. They include the following

1. Transposition does not require extensive DNA sequence homology. Transposition occurs normally when **RecA** is absent from a host, suggesting that **homologous recombination** events are not involved.

2. DNA synthesis is involved in bacterial **transposition**. **Transposition** always involves duplication of the target site, the short sequence (3-12 base pairs) at which the transposable element is inserted. In many instances the **transposable element** is itself replicated, with one copy being deposited in the new sequence and one remaining in the donor sequence.

3. **Transposable elements** can restructure a host chromosome. A **transposable element** can move from one site to another within the same chromosome, producing two homologous sequences resident in the same chromosome. Depending on whether these sequences are oriented identically or in reverse, homologous recombination between them can yield a deletion or an inversion, as shown in **Figure 25.34**.

4. **Transposable elements** can inactivate any gene into which they move (where insertion interrupts the coding sequence). Alternatively, **transposable elements** can activate adjacent genes (where a promoter, or transcriptional activator, might be created next to the gene). Abortive **transpositional** events can cause deletions or inversions in the chromosome. Insertional inactivation of genes is useful for isolating mutants defective in specific functions and for mapping genes.

Three different classes of transposable elements in bacteria, with general structures are shown in [Figure 25.35](#).

1. [Class I elements](#); and
2. [Class II elements](#); and
3. [Class III elements](#).

[Table 25.4](#) summarizes the properties of a number of transposons and insertion sequences. Each transposon (conventionally referred to with the abbreviation Tn) and IS inserts at a specific target sequence of five or nine base pairs in the examples shown. Insertion involves a duplication of that site, and it results in two copies of the target sequence, one on each side of the integrated element ([Figure 25.36](#)). It seems likely that this results from the action of **transposase**, which generates a staggered cut that brackets the target sequence. Attachment of the mobile element to each end results in gaps, which are then filled and ligated to generate the flanking direct repeats.

The **transposable element** never exists as free linear DNA. The currently favored model to explain how the ends of the element are generated to join with the ends of the staggered cut of the target sequence is shown in [Figure 25.37](#). It involves the following steps:

1. The **transposase** introduces both the staggered cuts in the target site and a nick at each of the 3' ends of the element, precisely between the transposon sequence and the flanking direct repeat.
2. The free 5' ends in the recipient DNA target sequence are joined to the 3' ends of the element. Two outcomes are then possible.
 - 3a. In simple **transposition** the joining is followed by cutting of the 5' ends of the transposon, also immediately adjacent to the flanking sequences. This gives a gapped structure like that shown in [Figure 25.36](#), which can be filled and closed by DNA polymerase and ligase. In this form of transposition, only the target sequence is copied; the donor chromosome suffers a lethal double-strand break. Tn10 **transposes** by a conservative mechanism, with both original strands somehow transferred to the new location.
 - 3b. The other process, replicative **transposition**, requires the enzyme resolvase, so it occurs only with [class II](#) and [class III](#) elements. The 3' ends of the target chromosome, after the first cutting and splicing, serve as replicative primers for copying both the gaps ([Figure 25.37](#)) and the two strands of the **transposable element** itself. Ligase action

generates a cointegrate, a large circular structure containing both donor and target chromosomes with two freshly replicated copies of the transposable element. The other enzyme, resolvase, catalyzes site-specific recombination between the two elements, resulting in one copy of the transposable element inserted into each of the two chromosomes.

See also: [Recombination](#), [site-specific recombination](#), [gene rearrangements](#)

INTERNET LINK: [Transposon and Transposase Tagging](#)

RecA



RecA is a protein in *E. coli* involved in recombinational repair of damaged DNA and in SOS repair (also called error prone repair). **RecA** catalyzes strand pairing, or strand assimilation—the joining of two different DNAs by homologous base pairing with each other. **RecA** is also a genetic regulator, activating the synthesis of many proteins, including DNA repair proteins, that help a bacterium adapt to a variety of metabolic stresses. Bacteria carrying mutations in *recA* are defective in general recombination and DNA repair.

RecA is a multifunctional protein with Mr of about 38,000. In recombination it promotes the pairing of homologous strands, in connection with recombinational repair. Several strand-pairing reactions can be demonstrated *in vitro*, as summarized in [Figure 25.23](#). For example, a circular, single-strand DNA can invade a homologous linear duplex (such as the linearized replicative form of phage Φ X174 DNA). **RecA**-catalyzed strand invasion and assimilation reactions *in vitro* have three requirements: (1) sequence homology (at least 40-60 base pairs) between the reacting DNAs, (2) a free end on one or both of the reactants, and (3) a single-strand region on one or both of the partners.

In vitro studies of these reactions reveal five distinct steps in **RecA**-promoted strand assimilation ([Figure 25.24](#)). In step 1, **RecA** coats the single-strand DNA to form a nucleoprotein filament of regular structure, in which the DNA length is extended by about 50% relative to its length in a duplex. In step 2, known as synapsis, the coated single-strand DNA reacts with a duplex, not necessarily at a homologous sequence. In step 3, homologous alignment, the two DNAs move with respect to each other until homologous sequences come into contact. This process requires ATP, but that ATP need not be cleaved, because **ATP^γS**, a noncleavable analog of ATP, can substitute. In step 4, a joint molecule is formed by base pairing between the two reacting molecules. **RecA** catalyzes local denaturation of the duplex partner and strand exchange with the single-strand partner. Finally (step 5), branch migration, occurs, essentially a continuation of joint molecule formation. The incoming strand pairs with its homolog, using the energy of ATP cleavage to advance (in a 5' → 3' direction relative to the single-strand DNA) and displacing the other strand as it moves. In this respect, **RecA** acts as a helicase.

LexA is a repressor that binds to at least 15 different operators scattered about the *E. coli* genome. Each operator controls the transcription of one or more proteins that help the cell respond after environmental damage that might harm the genetic apparatus. These proteins include the gene products of *uvrA* and *uvrB*, involved in excision repair; *umuC,D*, involved in error-prone mutagenesis; *sulA*, involved in cell division control; *recA* itself; *lexA* itself; and several genes of unknown function, including *dinA*, *dinB*, and *dinF*. In a healthy cell, *lexA* and *recA* are expressed at low levels, with sufficient LexA protein to turn off the synthesis of the other SOS genes completely. LexA protein does not completely abolish either *lexA* transcription or that of *recA*. The trigger that activates the SOS system after damage is thought to be single-strand DNA. **RecA** binding within a gapped DNA activates a proteolytic activity of **RecA** (by a mechanism not yet clear) that results in cleavage of LexA. Intracellular levels of LexA thus decrease, removing the LexA barrier to *recA* transcription, as well as other DNA repair genes. **RecA**

protein and DNA repair gene products accumulates in large amounts.

See also: [Recombination Repair](#), [RecA/SOS Response](#), [SOS Regulon](#)

Figure 25.23: RecA protein-mediated DNA strand exchange reactions.

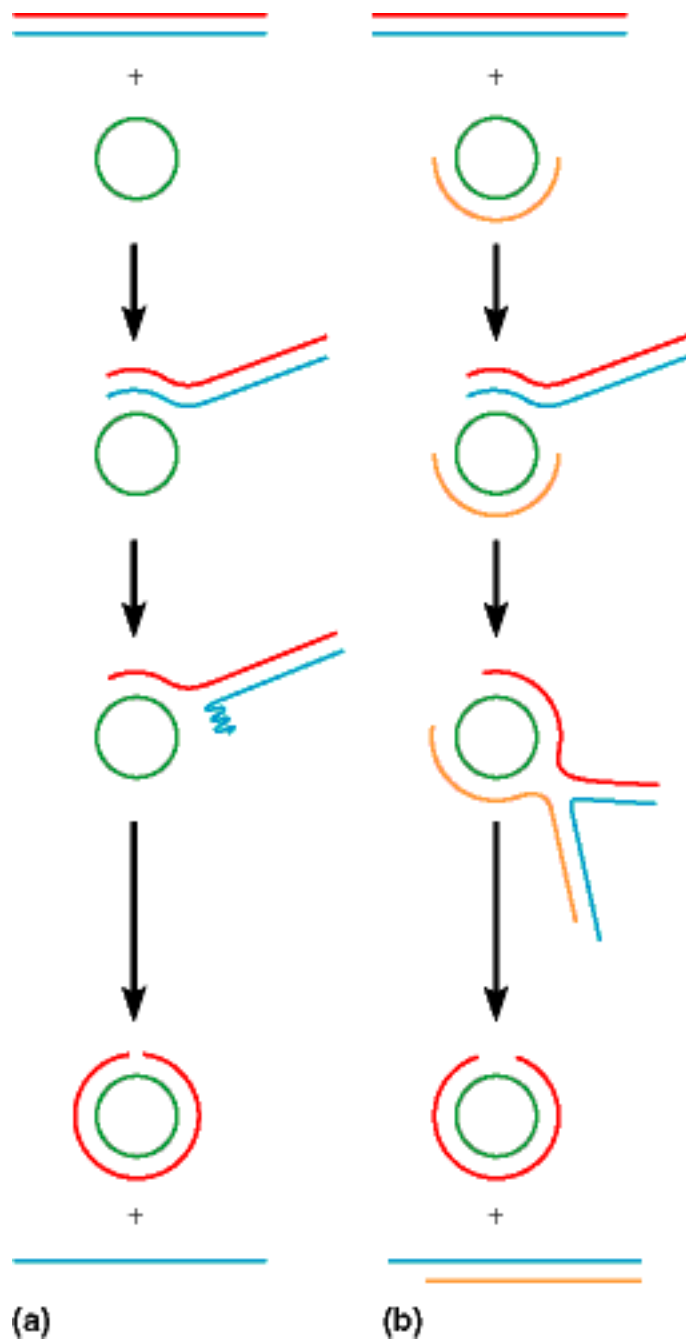
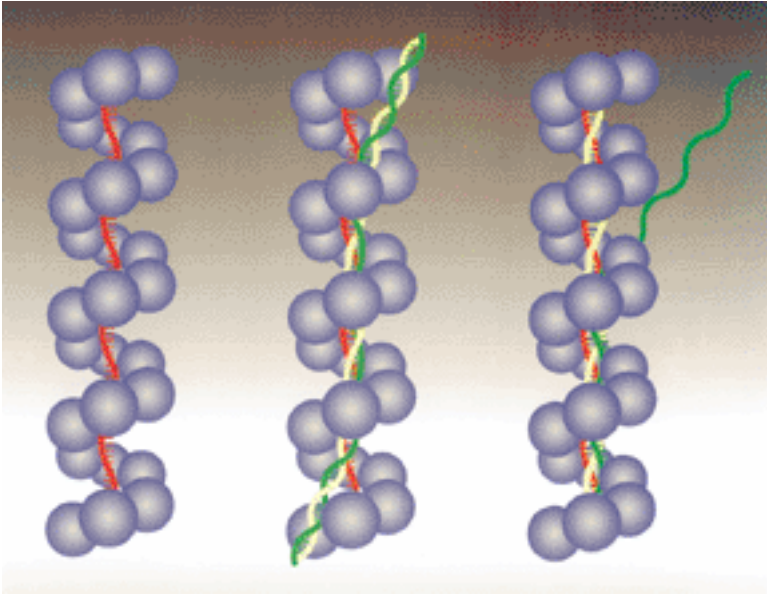

Figure 25.24: A model for RecA-mediated strand exchange.



Courtesy of M. Kubista et al., *Biological Structure and Dynamics*, R. H. Sarma and M. H. Sarma, eds. (Schenectady, New York: Adenine Press, 1996), pp. 49-59. © 1996 Adenine Press, Inc.

ATP- γ

ATP- γ -S is a derivative of [ATP](#) containing sulfate in place of one of the phosphates. The molecule has the same shape as ATP, but cannot be cleaved by enzymes to release energy.

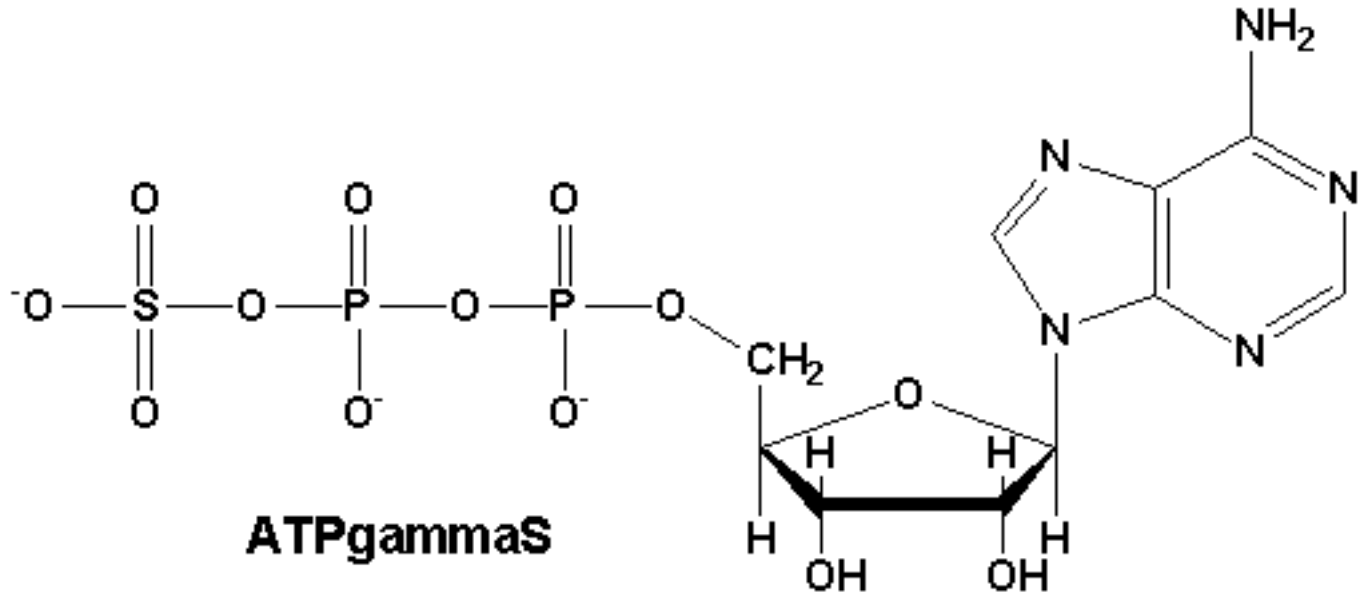

See also: [RecA](#)

Recombinational Repair

When replicative DNA polymerase encounters a thymine dimer, it cannot replicate past the site. Deoxyadenylate is incorporated opposite the first [thymine](#) base in the template, but the double helix distortion induced by the [thymine dimer](#) causes the structure to be recognized as a mismatch, and the polymerase "idles" at the damage site, converting [dATP](#) to [dAMP](#) by a continual process of insertion and exonucleolytic cleavage (due to proofreading).

Synthesis of an Okazaki fragment (see [here](#)) can commence on the other side of the damaged site, leaving a gap opposite the thymine dimer. The gap would be lethal if unrepaired, however, because it would generate a double-strand break in the next round of replication.

Because the gap that is generated opposite a thymine dimer is created by faulty replication, the gap is close to the replication fork. Therefore, it is also close to the corresponding region on the other daughter duplex ([Figure 25.15](#)). If that region has itself not sustained damage, the [RecA protein](#) (*E. coli*) can initiate **recombination** between two homologous duplexes.

1. The uninvolved parental strand, which is complementary to the damaged parental strand, recombines into the gap, opposite the damaged site.
2. A gap now exists in the previously undamaged arm, but because it lies opposite an undamaged template, it can be filled by action of [DNA polymerase](#) and [DNA ligase](#).
3. The [thymine dimer](#) itself is not repaired in this process, but the process allows time for the excision system to come in later and repair this damage.

[RecA](#) protein is required for daughter-strand gap repair, particularly in the first reaction, where the undamaged parental strand undergoes pairing with the parental strand opposite the gap.

See also: [RecA / SOS Response](#), [Postreplication Repair](#)

INTERNET LINKS:

1. [DNA Repair](#)
 2. [The Recombination Pages](#)
-

Thymine Dimer

A **thymine dimer** is a covalent linked between adjacent two **thymine** bases within a strand of DNA. **Thymine dimers** arise from ultraviolet-light induced formation of covalent bonds, as shown in [Figure 25.9](#). Cells take several approaches to repairing thymine dimers, including [photoreactivation](#) ([Figure 25.10](#)), [nucleotide excision repair](#) ([Figure 25.12](#)), [base excision repair](#) ([Figure 25.13](#)), and [recombinational repair](#) ([Figure 25.15](#)).

See also: [Pyrimidine Dimers](#), [RecA/SOS Response](#)

Nucleotide Excision Repair

Nucleotide excision repair is a process whereby a damaged section of a DNA chain is cut out, or excised, followed by the action of first DNA polymerase and then DNA ligase to regenerate a covalently closed duplex at the site of the original damage.

The enzyme system involved, which in *E. coli* includes the products of the *uvrA*, *uvrB*, and *uvrC* genes, acts upon a number of DNA-damaged sites containing lesions that may be quite bulky. Very similar systems exist in mammalian cells and in yeast.

As shown in [Figure 25.12](#), the three-subunit UvrABC enzyme recognizes a lesion and, with the help of ATP hydrolysis, forces DNA to bend, leading to cleavage of the damaged strand at two sites--eight nucleotides to the 5' side of the damaged site and four or five nucleotides to the 3' side. The end result is a gap 12 or 13 nucleotides in length, with a 3' hydroxyl group and a 5' phosphate at the ends. Polymerase and ligase action then replaces the damaged 12-mer or 13-mer with undamaged DNA.

Helicase II, the product of the *uvrD* gene, is also required, presumably to unwind and remove the excised oligonucleotide, which is ultimately broken down by other enzymes. The UvrABC enzyme is not a classical endonuclease, because it cuts at two distinct sites, so the term **excinuclease** has been proposed for it, denoting its role in **excision repair**. This system also repairs DNA damage that results when two strands covalently crosslink to each other. In this case, the two strands are repaired sequentially (one after the other) in order to preserve an intact template strand.

A human **excinuclease** cleaves at positions -22 and +6 relative to a [thymine dimer](#). A significant difference between this and the UvrABC enzyme is the involvement of two different endonucleases--one for cutting on the 5' side and one on the 3' side. The disease, xeroderma pigmentosum (XP), is actually a family of diseases, in which one or more enzymes of the **excision** pathway are deficient. The biological consequences of XP include extreme sensitivity to sunlight and a high incidence of skin cancers. In affected humans, there is at present no known way to treat the condition.

Recent studies of **excision repair** show that active genes (those undergoing transcription) are preferred substrates for **excision repair**, and within these genes the template DNA strand is preferentially repaired. Thus, the repair machinery is somehow directed toward sites where repair of DNA damage will do the most good. Transcription-coupled repair may initiate when a transcribing RNA polymerase stalls at the site of a DNA lesion. BRCA 1, a gene associated with increased risk of breast and ovarian cancer, has been implicated in transcription-coupled excision repair.

See also: [Types and Consequences of DNA Damage](#), [DNA-N-Glycosylases](#)

INTERNET LINKS:

1. [Nucleotide Excision Repair](#)
 2. [Xeroderma Pigmentosum](#)
 3. [Xeroderma Pigmentaosum Technical Notes](#)
 4. [DNA Repair](#)
-
-

Figure 25.12: Excision repair of thymine dimers by the UvrABC excinuclease of *E. coli*.

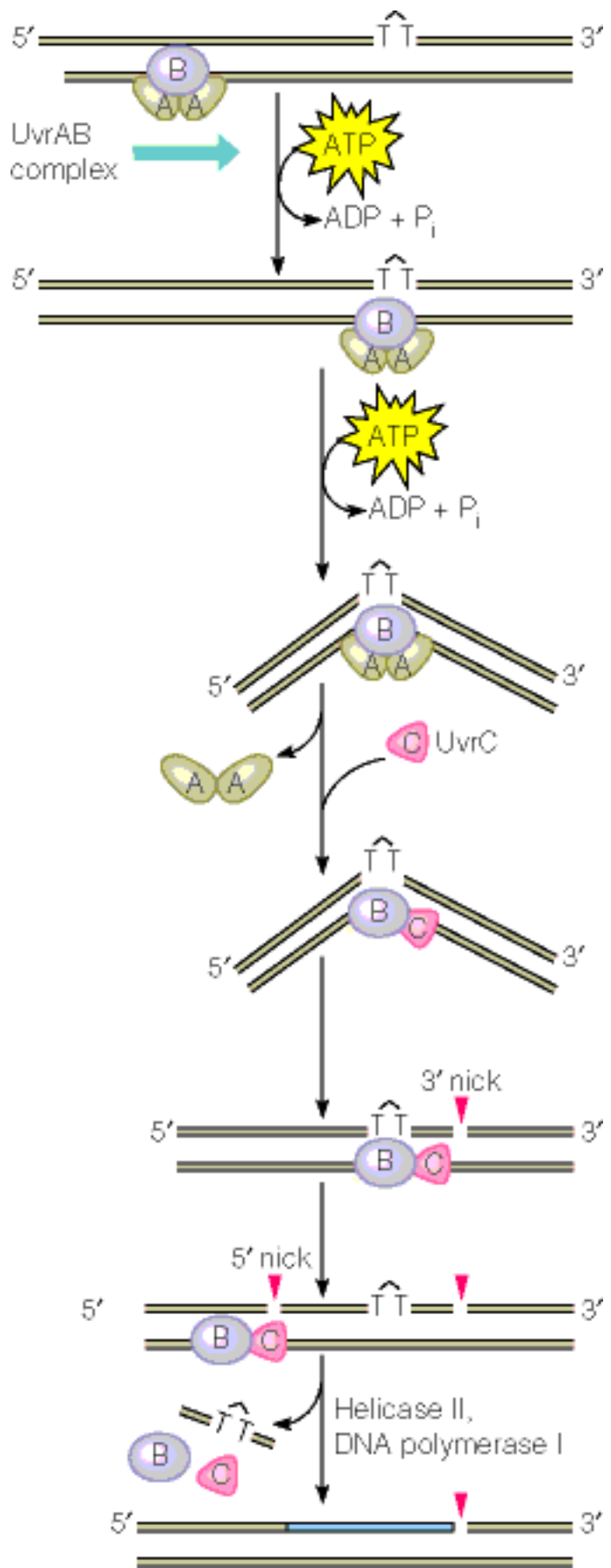

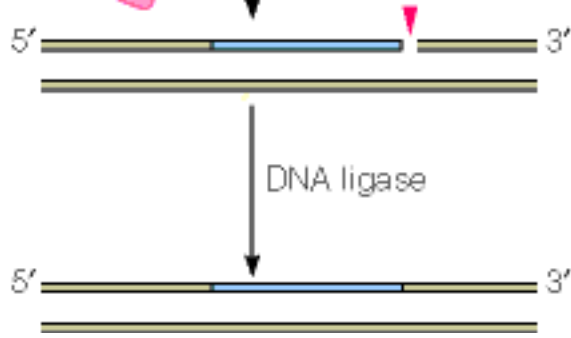

Adapted from A. Sancar and J. E. Hearst, *Science* (1993) 259:1415-1420. © 1993 AAAS.

Figure 25.15: Recombinational repair.

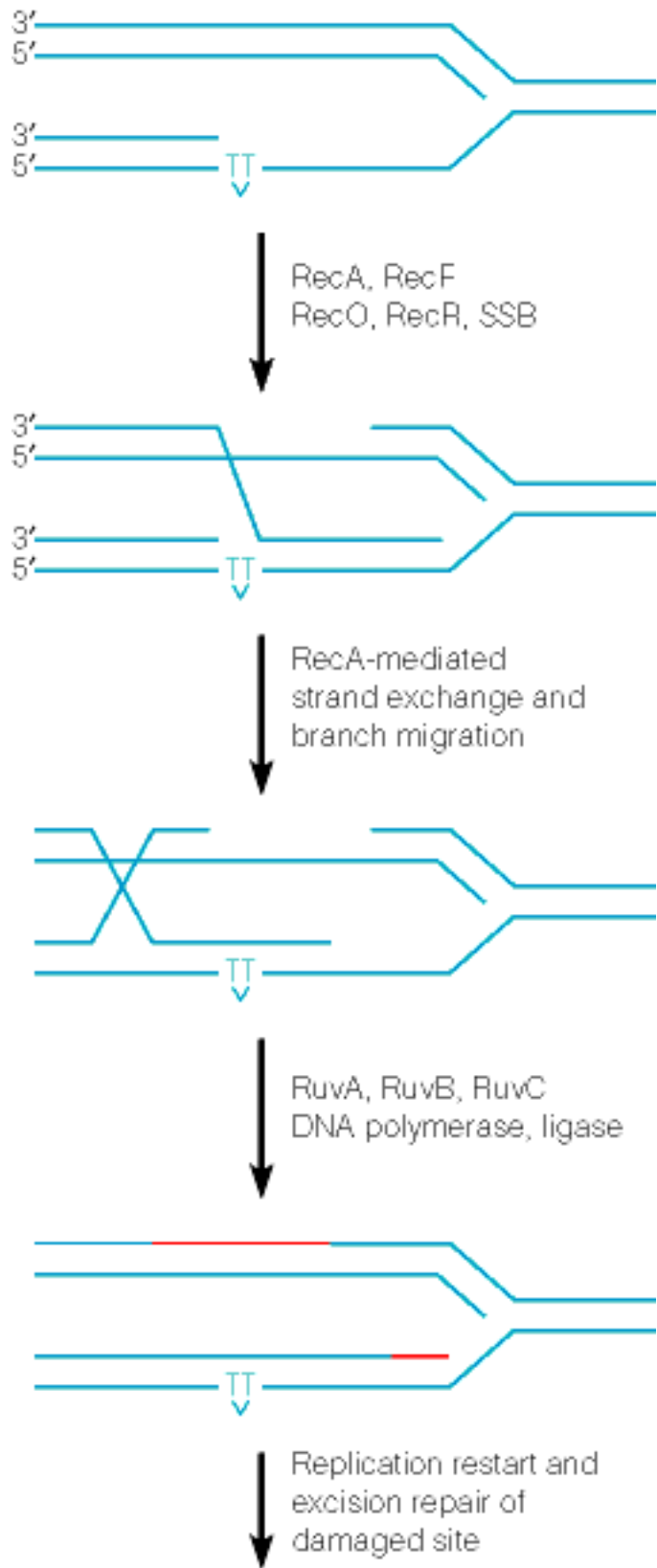

RecA/SOS Response

Bacteria carrying mutations in the *recA* gene are defective in general recombination and DNA repair. Bacteria deficient in **RecA** protein have a complex phenotype, including defective DNA repair. Two important properties of RecA are as follows:

1. **RecA** catalyzes strand pairing, or strand assimilation-the joining of two different DNAs by homologous base pairing with each other.
2. **RecA** is a genetic regulator, activating the synthesis of many proteins (including DNA repair proteins) that help a bacterium adapt to a variety of metabolic stresses. This adaptation is called the **SOS response**. The transcriptional activations and a fuller description of the **SOS response** are presented [here](#)

The bacterial **SOS response** helps the cell to save itself in the presence of potentially lethal stresses, such as ultraviolet irradiation, [thymine](#) starvation, DNA-modifying reagents, and inactivation of genes essential to DNA replication.

The effects of the **SOS response** are confusing. They include mutagenesis, filamentation (in which cells elongate by growth but don't divide), and activated excision repair. Mutagenesis occurs because, under **SOS** conditions, the gaps that are formed opposite [thymine dimers](#) can be filled by replication rather than by recombination (see [here](#)), and this replication is extremely inaccurate. In fact, error prone replication is the principal pathway by which ultraviolet light stimulates mutagenesis in bacteria.

A pair of bacterial genes, called *umuC* and *umuD* have been implicated in error prone repair. After expression of the two genes, the *umuD* gene product undergoes proteolytic cleavage to give the UmuD' protein. Two of these combine with UmuC (the protein product of *umuC*) to yield trimeric UmuD'2C. This trimeric complex may be the error prone polymerase.

Why do cells have such a mechanism for accumulating mutations? It is not known for sure, but it probably represents a last gasp chance for the cell to survive a harsh treatment.

It is not known whether eukaryotic cells have a comparable **SOS process**.

See also: [Postreplication Repair](#), [Recombinational Repair](#), [Prokaryotic Mismatch Repair](#), [Eukaryotic Mismatch Repair](#), [SOS Regulon](#) (from Chapter 26)

INTERNET LINK: [The Recombination Pages](#)

SOS Regulon

cI Inactivation - In order for λ phage to convert from lysogeny to lytic growth, the cI repressor must be inactivated. Under conditions of DNA damage, the cI repressor is inactivated by proteolytic cleavage of the *E. coli* **SOS system**, one of the elements in error-prone DNA repair, in which the genes are controlled by a single repressor-operator system. Such a set of unlinked genes, regulated by a common mechanism, is called a **regulon**.

SOS regulon controls - The control elements in the *E. coli* **SOS regulon** are the products of genes *lexA* and *recA*. **RecA** protein stimulates DNA strand pairing during recombination. Remarkably, this small protein has an enzymatic activity in addition to the activities involved in recombination. When bound to single-strand DNA, RecA can stimulate proteolytic cleavage of the proteins encoded by *cI*, *lexA*, and *umuD*. LexA is a repressor that binds to at least 15 different operators scattered about the *E. coli* genome (**Figure 26.32**). Each operator controls the transcription of one or more proteins that help the cell respond after environmental damage that might harm the genetic apparatus. These proteins include the gene products of *uvrA* and *uvrB*, involved in nucleotide excision repair; *umuC,D*, involved in error-prone mutagenesis; *sulA*, involved in cell division control; *dnaA*, the structural gene for DNA polymerase II; *recA* itself; *lexA* itself; and several genes of unknown function, including *dinA*, *dinB*, and *dinF*.

Single-strand DNA trigger - In a healthy cell, *lexA* and *recA* are expressed at low levels, with sufficient LexA protein to turn off the synthesis of the other **SOS genes** completely. LexA protein does not completely abolish the transcription of either *lexA* or *recA*. The trigger that activates the **SOS system** after damage is thought to be single-strand DNA. UV irradiation and other conditions generate gapped DNA structures that induce the SOS system. RecA binding within a gap activates proteolysis by a mechanism not yet clear. Intracellular levels of LexA decrease, removing the LexA barrier to *recA* transcription. RecA protein accumulates in large amounts. Cleavage of the LexA protein activates transcription of all genes under *lexA* control. In a λ lysogen, cleavage of λ cI repressor is stimulated, as well, activating prophage excision and replication.

Sequence Similarities - DNA sequence analysis of operators that respond to LexA has yielded a consensus sequence, with 7 highly conserved bases in a 20-base-pair region. Different LexA-sensitive genes have this sequence located quite differently with respect to the transcriptional start site. Therefore, it appears that the exact location of bound repressor is not critical to ensure that transcription will be inhibited.

See also: [SOS Response](#) (from Chapter 25)

INTERNET LINK: [Regulon DB, A Database of Transcriptional Regulation in *E. coli*](#)



Figure 26.32: The SOS regulon.

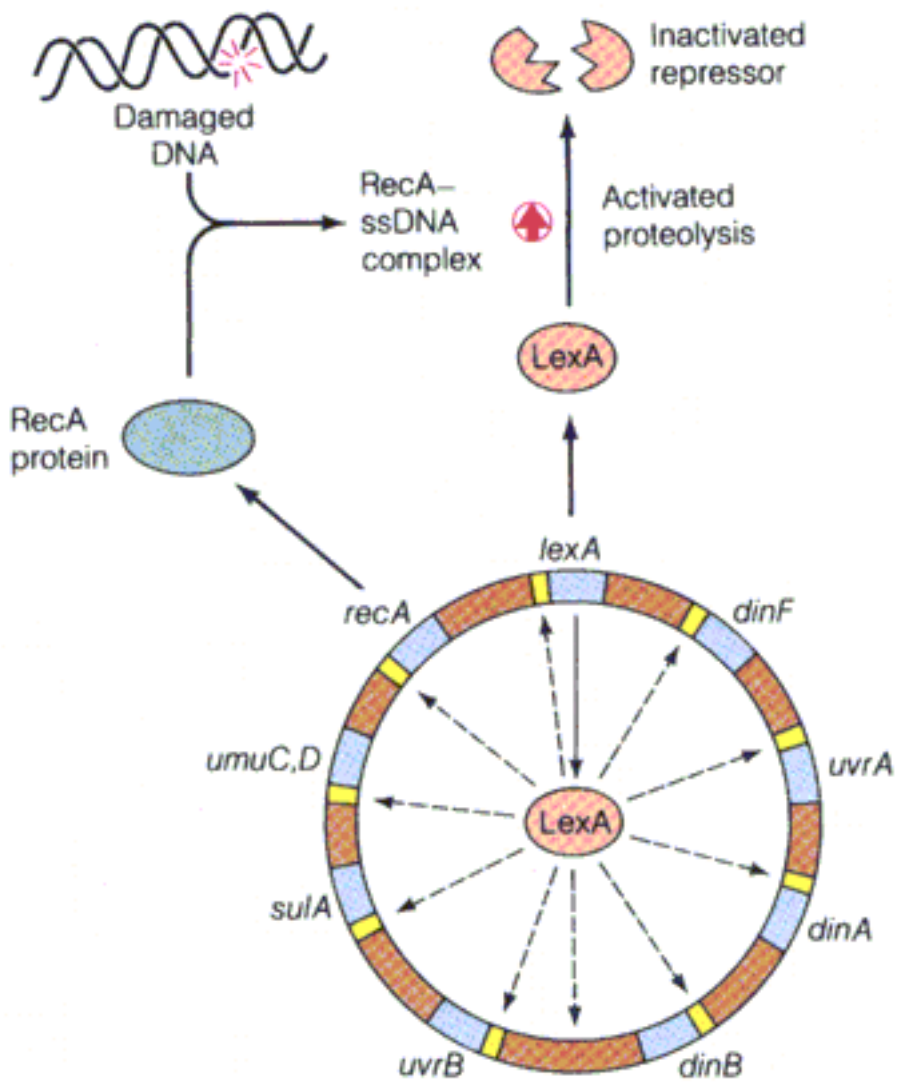

Postreplication Repair

Postreplication repair refers to processes that attempt to fix mismatches, gaps, or damage to DNA that escape the repair processes that occur during replication (such as proofreading--see [here](#)).

When a replicative polymerase encounters a thymine dimer, it cannot replicate past the site.

Deoxyadenylate can be incorporated opposite the first **thymine** base in the template, but the double helix distortion induced by the thymine dimer, causes the structure to be recognized as a mismatch, and the polymerase "idles" at the damage site, converting **dATP** to **dAMP** by a continual process of insertion and exonucleolytic cleavage (due to proofreading).

Synthesis of an Okazaki fragment (see [here](#)) can commence opposite the damaged site, leaving a gap opposite the thymine dimer. The gap would be lethal if unrepaired, however, because it would generate a double-strand break in the next round of replication.

Two distinct processes can repair the gap:

1. **Recombinational repair**, or daughter-strand gap repair
2. **SOS response**, or error-prone repair

Both processes depend critically (in *E. coli*) on a protein called **RecA**.

Another postreplication repair system is that of mismatch repair, which can repair replication mistakes that escape proofreading or which arise from chemical alteration of bases, such as deamination of **cytosine** to form **uracil**.

See also: [Mismatch Repair](#)

INTERNET LINK: [DNA Repair](#)

Prokaryotic Mismatch Repair

Mismatches, or non-Watson–Crick base pairs in a DNA duplex, can arise through the following processes:

1. Replication Errors;
2. Deamination of **5-methylcytosine** in DNA to yield **thymine**; and
3. Recombination between DNA strands that are not completely homologous.

The repair of replication errors is the best understood system. If DNA polymerase introduces an incorrect nucleotide and it is not corrected by 3' exonucleolytic proofreading activity of the enzyme (see [here](#)), the fully replicated DNA will contain a **mismatch** at that site. The error can be corrected by the process called **mismatch repair**.

In *E. coli* the proteins that participate in **mismatch repair** include the products of genes *mutH*, *mutL*, and *mutS*. Another required gene product has been identified as DNA helicase II. The *E. coli* single-stranded binding protein also appears to be involved.

The prokaryotic **mismatch correction system** works by "scanning" newly replicated DNA, looking for both **mismatched** bases and single-base insertions or deletions. When it finds a problem, part of one strand containing the **mismatched** region is cut out and replaced ([Figure 25.16](#)).

The **mismatch repair system** must reliably recognize the proper strand to repair, for if it chose randomly, it would be incorrect half the time and there would be no gain in replication accuracy. **Mismatch repair** enzymes can identify the newly replicated strand because it is unmethylated for a short period of time after replication. Only later, after the replication fork passes, is the DNA methylation completed. Thus, the parental strand is the methylated one. *E. coli* methylates primarily at the 'A' of the sequence GATC. As a result, recognition of an unmethylated GATC as far as 1 kbp or more away from the GATC site, in either direction, can help a cell identify which one is the newly replicated strand. After the methylation system has acted on all GATC sites in the daughter strand, it is too late for the **mismatch repair system** to recognize the more recently synthesized DNA strand, and thus cannot improve total DNA replication fidelity. However, by operating before methylation, the **mismatch repair system** increases overall replication fidelity by about 100-fold—from about 1 error in 10^8 base pairs replicated to about 1 in 10^{10} .

See also: [Eukaryotic Mismatch Repair](#), [Postreplication Repair](#)

INTERNET LINKS:

1. [DNA Repair](#)

2. [Mutations](#)

5-Methylcytosine

5-Methylcytosine (mC) is the sole methylated base found in eukaryotic DNA. In animals, methylation is found primarily in C residues that are immediately 5' to G residues (that is, in a sequence CpG). When such a C is methylated, so is the corresponding C in the complementary strand. In plant DNA, the methylated sequence is CpNpGp, where N can be any base.

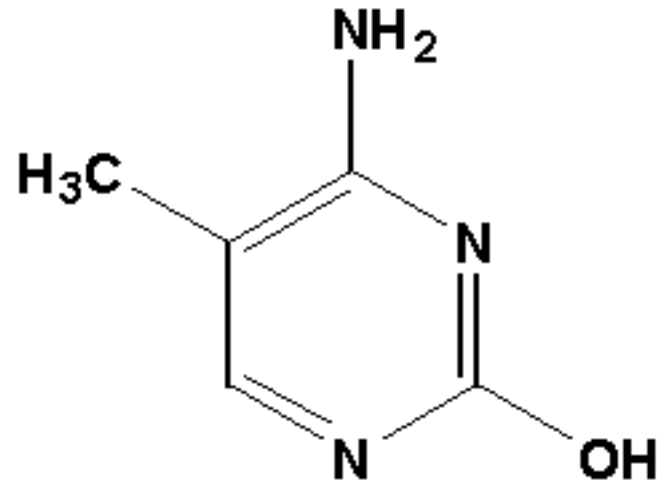

5-Methylcytosine

See also: [DNA Methylation](#), [Cytosine](#), [Prokaryotic Mismatch Repair](#)

DNA Methylation

Methylation underlies several important biological processes, including restriction and modification, mismatch error correction (a DNA repair process), and the control of eukaryotic gene expression. S-Adenosylmethionine (**AdoMet**) is the substrate for **methylation** of both **RNA** and **DNA**. **Methylation** occurs at the polynucleotide level, with transfer of a methyl group from AdoMet to a nucleotide residue.

The sole **methylated** base found in eukaryotic DNA is **5-methylcytosine (mC)**. In animals, **methylation** is found primarily in C residues that are immediately 5' to G residues (that is, in a sequence CpG). When such a C is **methylated**, so is the corresponding C in the complementary strand. In plant DNA, the methylated sequence is CpNpGp, where N can be any base.

In prokaryotic DNA the major **methylated** bases are **N⁶-methyladenine** (mA) and to a lesser extent **N⁴-methylcytosine**. **Methylation** in bacteria occurs at specific sites. In *E. coli*, **methylation** of A residues in the sequence 5'-GATC-3' is involved in mismatch error correction, and it plays a role in controlling initiation of DNA replication. **Methylation** at other sites protects DNA against cleavage by restriction endonucleases (described [here](#)). Structural studies on a bacterial **DNA methylase** have shown that the bases undergoing **methylation** rotate completely out of the DNA duplex and into a catalytic pocket within the enzyme structure. Other enzymes that work on bases, such as **uracil-N-glycosylase**, operate similarly.

The biological significance of **DNA methylation** in prokaryotes is now fairly clear, but its importance in eukaryotes has not yet been defined. What is known, however, is that **methylation** at a particular site is a heritable phenomenon. That is, when eukaryotic DNA replicates, a maintenance **methylase** ensures that all of the sites that were **methylated** in parental DNA are **methylated** in daughter DNA. The process is shown in [Figure 25.3a](#).

Methylation occurs after replication and **unmethylated** sites in parental DNA remain **unmethylated** in daughter DNA. **5-Azacytidine**, a cytidine analog that is metabolized like **cytidine** to the analog of **dCTP** (but cannot be **methylated**), can be incorporated into DNA. After replication replaces the modified C with a real C, it too remains **unmethylated** (see [Figure 25.3b](#)).

Changes in **methylation** can have effects on transcription. For example, azacytidine treatment can cause adult bone marrow cells to reactivate the synthesis of fetal hemoglobin, which is normally turned off during development.

Methylation may be involved in carcinogenesis. Deamination of an mC residue in DNA creates a G-T base pair, an event that could create a GC ---> AT mutation. Most sequence alterations in tumor cell DNAs involve GC --->AT transitions.

See also: [Mismatch repair](#)

INTERNET LINK: [The Effect of Site-Specific Methylation on Promega Restriction Enzymes](#)

N⁶-Methyladenine (mA)

N⁶-Methyladenine is a methylated base found in prokaryotic DNA. In *E. coli*, methylation of A residues in the sequence 5'-GATC-3' is involved in mismatch error correction, and it plays a role in controlling initiation of DNA replication. Methylation at other sites protects DNA against cleavage by restriction endonucleases (described [here](#)).

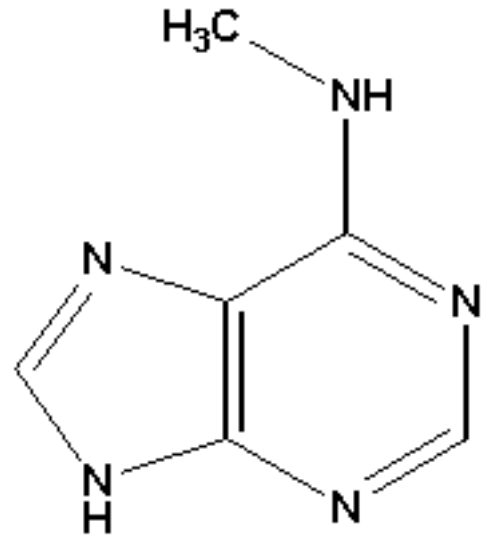

N6-methyladenine (mA)

See also: [DNA Methylation](#), [Prokaryotic Mismatch Repair](#), [Initiation of DNA Replication](#), [N⁴-Methylcytosine](#)

INTERNET LINK: [The Effect of Site-Specific Methylation on Promega Restriction Enzymes](#)

Restriction-Modification

One of the most important developments in the recent history of biochemistry is the discovery of **restriction endonucleases** (also called restriction enzymes). **Restriction endonucleases** are enzymes that catalyze the double-strand cleavage of DNA at specific base sequences. That is, **restriction enzymes** cut DNA strands at specific DNA sequences, generating fragments of specific sizes that can be separated and visualized on gel electrophoresis ([Figure 25.6](#)).

Restriction enzymes are widespread among bacteria as part of a defense system called **restriction-modification**. Typically these systems are composed of a gene that encodes a **methylase** that methylates a specific, short DNA sequence. This same sequence is recognized by the **restriction enzyme**, but the enzyme is inhibited from cutting by the methyl group. Invading viruses, however, have no such methyl group and are cut by the restriction enzyme. Thus, **restriction-modification** cleaves only invading DNA from outside, not the cell's own DNA. Occasionally, however, a virus manages to invade and be modified by the **methylase** before the **restriction enzyme** can act. When this happens, the virus is not blocked by the **restriction-modification system** of the host bacterium and can infect with a much higher frequency ([Figure 25.5](#)).

See also: [Restriction Enzyme Types](#), [DNA Methylation](#)

INTERNET LINK: [REBASE, The Restriction Enzyme Database](#)

Figure 25.6: Fragmentation of phage λ DNA with EcoRI or BamHI.

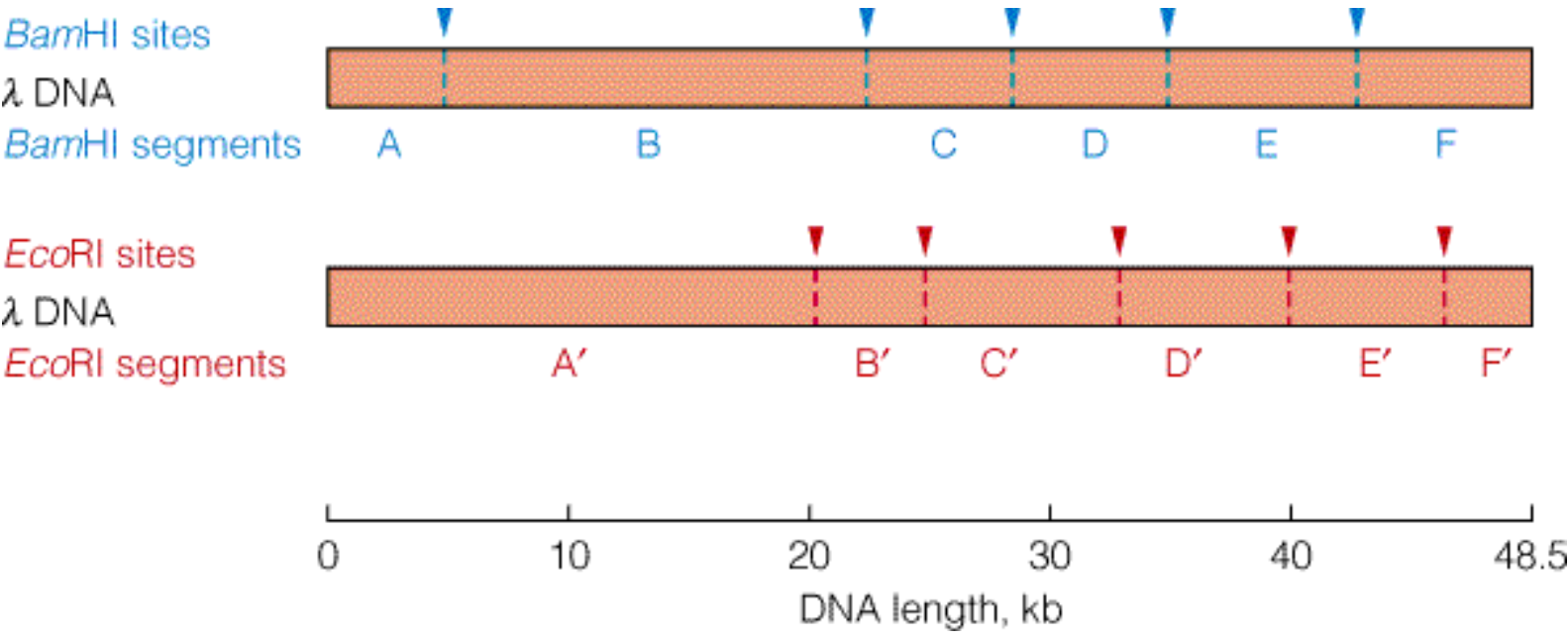
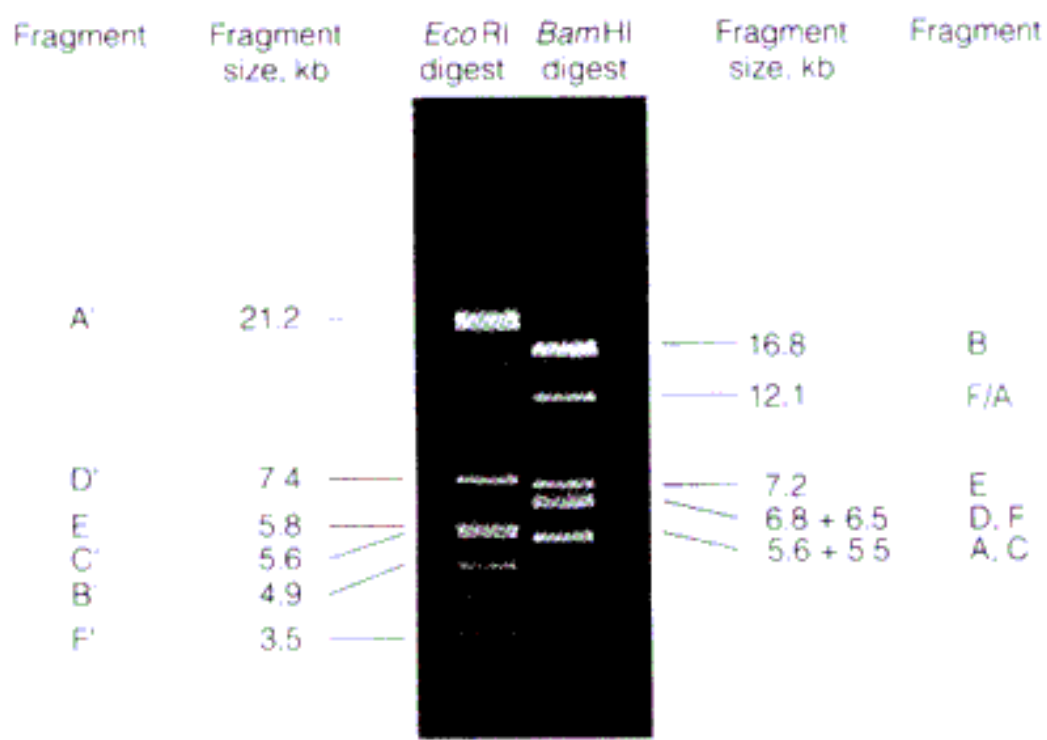

(a) Courtesy of Catherine Z. Mathews.

Restriction Enzyme Types

At present, three different types of **restriction-modification systems** are known—types I, II, and III. Each system consists of two distinct enzyme activities: a DNA methylase and an endonuclease that catalyzes a double-strand DNA break. The type II sequence-specific **endonucleases** are the most widely used ones in molecular biology.

Properties of each of the three types of **restriction systems** are discussed in the links below and are summarized in [Table 25.1](#):

[Type I](#)

[Type II](#)

[Type III](#)

See also: [DNA Methylation](#), [Restriction-Modification](#)

INTERNET LINK: [REBASE, The Restriction Enzyme Database](#)

Table 25.1



	Type I	Type II	Type III
Example	<i>EcoB</i>	<i>EcoRI</i>	<i>EcoPI</i>
Recognition site	TGAN ₈ TGCT	GAATTC	AGACC
Cleavage site	Up to 10 kbp away from recognition site	Between G and A (both strands)	24–26 base pairs 3' to recognition site
Methylation site	^m TGAN ₈ TGCT ACTN ₈ ACGA _m	^m GAATTC CTTAAG _m	^m AGACC (only one strand methylated)
Nuclease and methylase in one enzyme?	Yes	No	Yes
Requirements for cleavage	ATP, Mg ²⁺ , AdoMet	Mg ²⁺ or Mn ²⁺	Mg ²⁺ , AdoMet
Requirements for methylation	ATP, Mg ²⁺ , AdoMet	AdoMet	Mg ²⁺ , AdoMet

Note: Each methylated base is identified with the letter m. All sequences read 5' to 3', left to right.

Type I Restriction Endonucleases

Restriction-modification is a term for bacterial enzyme systems that cleave DNA sequences. Each system consists of two distinct enzyme activities: a DNA methylase and an endonuclease that catalyzes the double-strand DNA break. **Type I restriction endonuclease** systems have both methylase and nuclease activities in one protein molecule, which contains three subunits. One subunit contains the nuclease, one the methylase, and one a sequence recognition determinant. The recognition site is not symmetrical, and cleavage occurs some distance (up to 10 kbp) away from the recognition site, although methylation occurs within the recognition site.

For cleavage, the enzyme remains bound to the recognition site, and DNA is looped out around it, with concomitant supercoiling. About 10^5 **ATP** molecules are hydrolyzed per cleavage event. Energy is probably needed for both translocation of the enzyme and supercoiling of the DNA. Both ATP and **AdoMet** are required for the cleavage activity. AdoMet may be an allosteric activator, because it is not broken down during the reaction.

See also: [DNA Methylation](#), [Restriction-Modification](#), [Restriction Enzyme Types](#)

INTERNET LINK: [REBASE, The Restriction Enzyme Database](#)

Type II Restriction Endonucleases

Restriction-modification is a term for bacterial enzyme systems that cleave DNA sequences. Each system consists of two distinct enzyme activities: a DNA methylase and an endonuclease that catalyzes the double-strand DNA break. **Type II restriction endonucleases** have been of great value to research because most of them cut within the recognition sequence, making cleavage absolutely sequence specific. A divalent cation is required for cleavage, but **ATP** is not required. Each **type II nuclease** has a counterpart methylase, which binds to the same recognition sequence and methylates one nucleotide within that sequence. A hemimethylated DNA (i.e., DNA with a methyl group on one strand only) is a preferred substrate for the methylase but not for the nuclease, which generally cleaves only when the recognition site is unmethylated on both strands. Cleavage almost always creates 3' hydroxyl and 5' phosphate termini. Cleavage sites on the two strands may be offset by as much as four nucleotides (as in *EcoRI*), giving cuts with short, self-complementary, single-strand termini. Some enzymes cleave to give a 5'-terminated single-strand end ("overhang"), whereas others generate a 3' overhang. Other **type II nucleases**, including *SmaI* and *HindII*, generate blunt-ended fragments, in which the cutting sites are not offset. Most recognition sites are four, five, or six nucleotides in length, although a few **type II enzymes** recognize an eight-nucleotide sequence. Most show 2-fold rotational sequence symmetry, suggesting that the two enzyme subunits are also arranged symmetrically. **Table 25.2** shows the recognition sites for several widely used **type II nucleases**. Several hundred enzymes of this type have now been isolated. Some **type II nucleases**, such as *HindIII*, recognize multiple specific sequences, and some enzymes (such as *HgaI*) cleave at a site outside the recognition sequence.

Figure 25.7 shows one polypeptide subunit of the dimeric *EcoRI* restriction enzyme in contact with its DNA recognition sequence. The DNA is bound in a cleft of the enzyme, and the protein has an N-terminal "arm" that wraps about the DNA. Sequence specificity is maintained by 12 hydrogen bonds, which link the purine residues in the site to a glutamate and two arginine residues (not shown in the figure). The other subunit (not shown in the figure) contacts the substrate identically, accounting for the ability of the enzyme to catalyze symmetrical cleavages within the cutting site.

See also: [DNA Methylation](#), [Restriction-Modification](#), [Restriction Enzyme Types](#)

INTERNET LINK: [REBASE, The Restriction Enzyme Database](#)

Table 25.2

Enzyme	Bacterial Source	Restriction and Modification Site ^a
<i>Bam</i> HI	<i>Bacillus amyloliquefaciens</i> H	G↓GATCC
<i>Bgl</i> II	<i>B. globiggi</i>	A↓GATCT
<i>Eco</i> RI	<i>Escherichia coli</i> RY13	G↓A ^m ATTC
<i>Eco</i> RII	<i>E. coli</i> R245	CC ^m ↓GG
<i>Ha</i> ellI	<i>Haemophilus aegyptius</i>	GG↓C ^m C
<i>Hga</i> I	<i>H. gallinarum</i>	GACGCNNNNN↓ CTGCGNNNNNNNNNN↑
<i>Hha</i> I	<i>H. haemolyticus</i>	G ^m CG↓C
<i>Hind</i> II	<i>H. influenzae</i> Rd	GTPy↓PuA ^m C
<i>Hind</i> III	<i>H. influenzae</i> Rd	A ^m ↓AGCTT
<i>Hinf</i> I	<i>H. influenzae</i> Rf	G↓ANTC
<i>Hpa</i> I	<i>H. parainfluenzae</i>	GTT↓AAC
<i>Hpa</i> II	<i>H. parainfluenzae</i>	C↓C ^m GG
<i>Msp</i> I	<i>Moraxella</i> sp.	C↓CGG
<i>Not</i> I	<i>Nocardia rubra</i>	GC↓GGCCGC
<i>Ple</i> I	<i>Pseudomonas lemoignei</i>	GAGTCNNNN↓ CTCAGNNNNNN↑
<i>Pst</i> I	<i>Providencia stuartii</i>	CTGCA↓G
<i>Sal</i> I	<i>Streptomyces albus</i> G	G↓TCGAC
<i>Sma</i> I	<i>Serratia marcescens</i> Sb	CCC ^m ↓GGG
<i>Xba</i> I	<i>Xanthomonas badrii</i>	T↓CTAGA

^aThe methylated base in each site, where known, is identified with the letter m. All sequences read 5' to 3', left to right. The cleavage on the opposite strand in each case can be inferred from the symmetry of the site (except for *Hga*I and *Ple*I, each of which has an asymmetric site). Pu = purine, Py = pyrimidine, N = any base.

Figure 25.7: Structure of the EcoRI nuclease complexed with its DNA substrate.

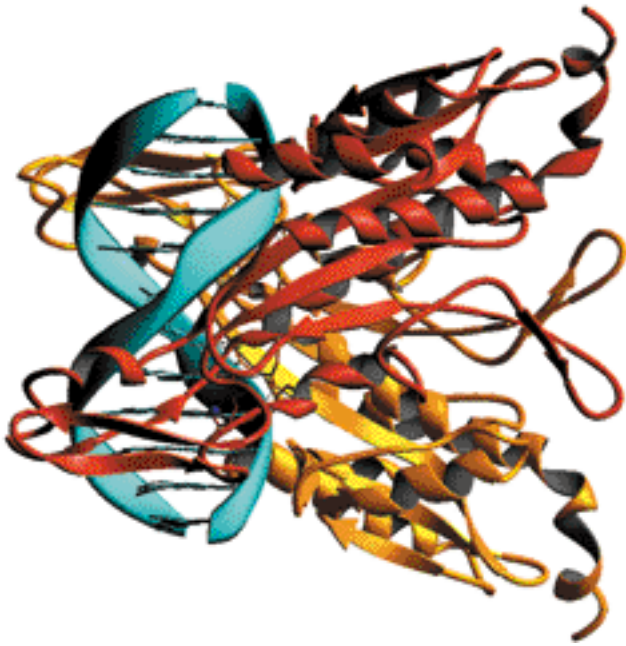

Reprinted with permission from J. A. McClarin et al., *Science* (1986) 234:1526-1541, ©1986 by the AAAS, provided by J. M. Rosenberg.

Type III Restriction Endonucleases

Restriction-modification is a term for bacterial enzyme systems that cleave DNA sequences. Each system consists of two distinct enzyme activities: a DNA methylase and an endonuclease that catalyzes the double-strand DNA break. **Type III** restriction endonuclease system resemble more closely the [type I](#) systems than the [type II](#) systems. **Type III** enzymes contain both nuclease and methylase activities in a two-subunit enzyme. They differ from type I enzymes in that they do not require [ATP](#), they modify just one DNA strand, and the cleavage site is fairly close to the recognition site.

See also: [DNA Methylation](#), [Restriction-Modification](#), [Restriction Enzyme Types](#)

INTERNET LINK: [REBASE, The Restriction Enzyme Database](#)

Figure 25.16: Methyl-directed mismatch repair in *E. coli*.

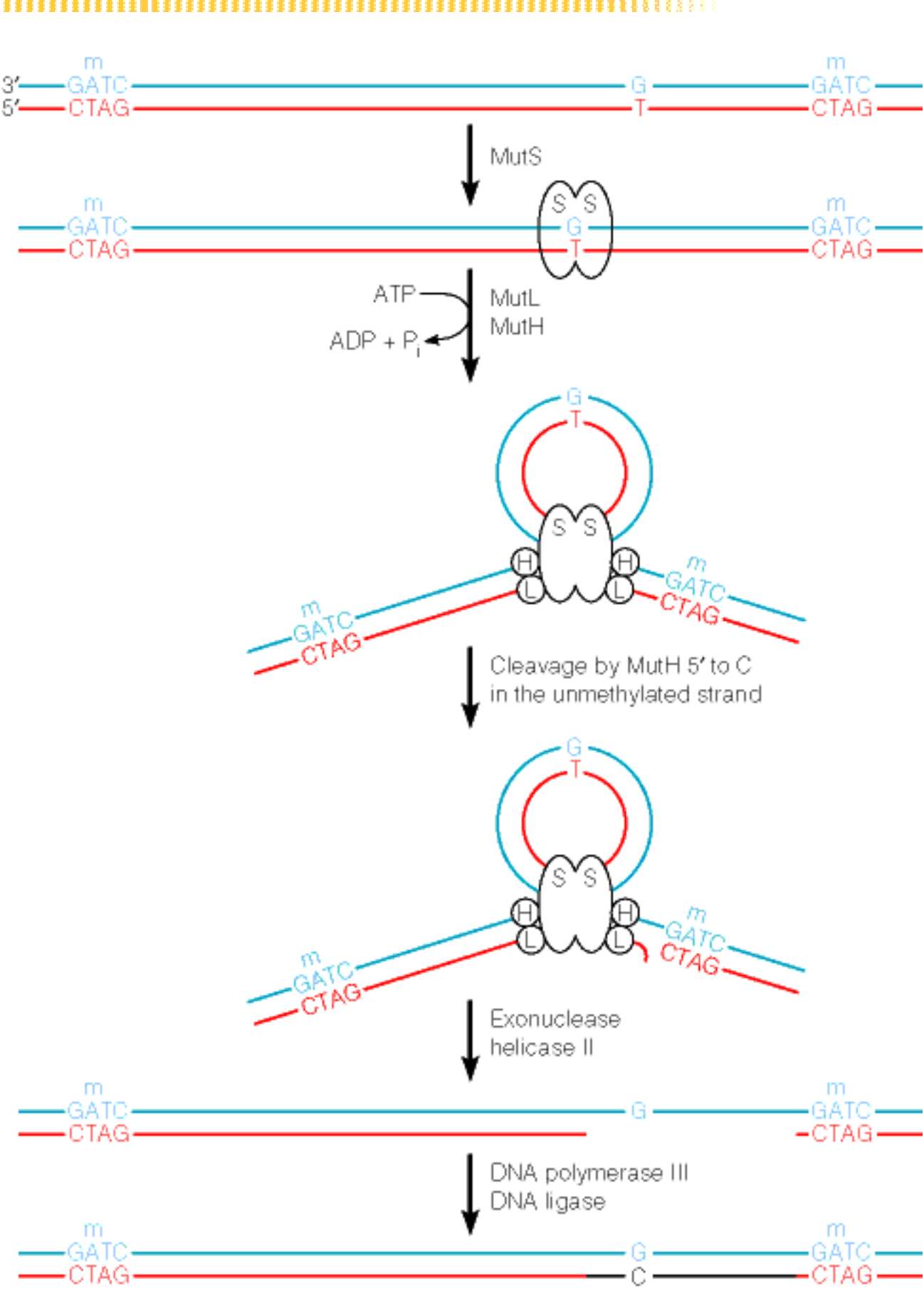

Eukaryotic Mismatch Repair

Mismatches, or non-Watson–Crick base pairs in a DNA duplex, can arise through the following processes:

1. Replication errors;
2. Deamination of 5-methylcytosine in DNA to yield thymine; and
3. Recombination between DNA segments that are not completely homologous.

If DNA polymerase introduces an incorrect nucleotide and it is not corrected by 3' exonucleolytic proofreading (see [here](#)), the fully replicated DNA will contain a mismatch at that site. The error can be corrected by the process called **mismatch repair**.

E. coli proteins that participate in mismatch repair include the products of genes *mutH*, *mutL*, and *mutS*.

A similar repair system operates in eukaryotic cells involving three proteins related to MutS (called MSH2, MSH3, and MSH6). Combinations of the proteins dimerize and work on specific mismatches. Several homologs of MutL are known in eukaryotic cells, but no analog is known for MutH. It is not known in eukaryotic systems how the newly replicated strand is recognized because selective methylation does not appear to be involved. Mutations in the genes that control mismatch repair cause cells to have a higher than normal mutation rate (mutator phenotype) and are associated with a greater tendency to form tumors.

Mutations in mismatch repair genes have been identified in individuals with an inherited cancer predisposition called HNPCC (hereditary non-polyposis colon cancer). Tumor cells from HNPCC patients exhibit a phenomenon called microsatellite instability. DNA in these cells contain a large number of mutations in regions of the genome containing repeats of single-, double-, and triple-nucleotide sequences. The mutations usually create large increases in the number of repeating units in such sequences. These data suggest that the product and template strands normally "slip" at such sites so that DNA polymerase copies a short repeating sequence more than once, or else skips a segment. The heteroduplex arising from such a slippage would normally be corrected by mismatch repair, but cells from these individuals are unable to do so.

See also: [Prokaryotic Mismatch Repair](#), [Postreplication Repair](#)

INTERNET LINKS:

1. DNA Repair

2. Mutations

Figure 24.39: Replication of mitochondrial DNA.

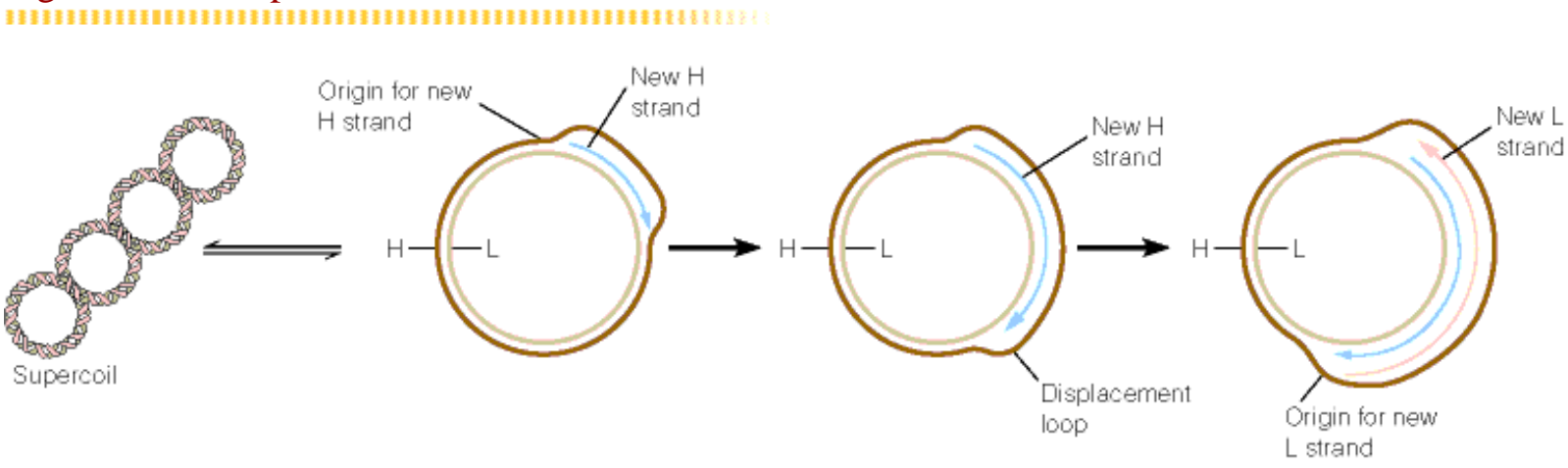

Replication of Linear Genomes

All known DNA polymerases are unable to initiate synthesis of a DNA strand without a preexisting "primer" sequence. Circular genomes overcome this limitation fairly easily, either by nicking one strand and using the exposed 3' end as a primer or by opening the duplex at an origin, starting with an RNA primer, and then replicating around the circle back to the starting point. The original RNA can be removed by DNA polymerase I via nick translation because the newly replicated strand returns back to the origin.

Not all genomes, however, are circular. Numerous linear genomes exist, including eukaryotic chromosomes, some bacteriophages, and some viruses. Full replication of **linear genomes** is a logistical problem ([Figure 24.40](#)), however, because a primer is needed for DNA polymerase. With circular chromosomes, RNA primers can be easily removed and replaced because the newly synthesized strand returns to the origin and can serve as a primer for DNA polymerase I to replace the ribonucleotides of the RNA primer with deoxyribonucleotides. There is no loss of nucleotides in this process.

If **linear chromosomes** employ RNA to initiate replication at the chromosomal termini, either they must have some mechanism for replacing the RNA with DNA or they must lose a bit of DNA with each round of replication. In reality, eukaryotic chromosomes opt for the latter scheme, losing a bit of the end of each chromosome (called a telomere) with each round of replication. Telomeres contain many repeats of a small oligonucleotide sequence and do not appear to code for any genes. The enzyme called telomerase can rebuild telomeres that have been shortened, to some extent, but it does not appear to be active in most cells. Fortunately, telomeric sequences are fairly long, so our cells can undergo a considerable amount of replication without loss of important coding sequences.

Viruses with linear DNA sequences have come up with a variety of mechanisms for fully replicating the ends of their chromosome. Two of these are depicted in [Figure 24.41](#).

Bacteriophages T4 and T7 contain terminally redundant DNA sequences that, in single-stranded form, can create concatemers ([Figure 24.41a, Step3](#)) that regenerate full terminal repeat sequences by recombination.

Bacteriophage ϕ 29 and the adenoviruses employ a completely different strategy ([Figure 24.41b](#)). They solve the problem by using a novel priming system that employs a protein covalently attached to the 5'-most nucleotide of each strand. In this case, there is no RNA that has to be removed because the terminal nucleotide that initiates the replication is a deoxyribonucleotide.

Poxviruses solve the problem in yet another way ([Figure 24.41c](#)). The two strands of their linear genome are covalently linked together. Bidirectional replication generates the duplex intermediate (step 3) and dual strand cutting and rearrangement regenerates the original structure.

See also: [Eukaryotic DNA Replication](#) (from Chapter 28)

INTERNET LINK: [Mammalian Telomere C-strand Synthesis](#)

Figure 24.40: The problem of completing the 5' end in copying a linear DNA molecule.

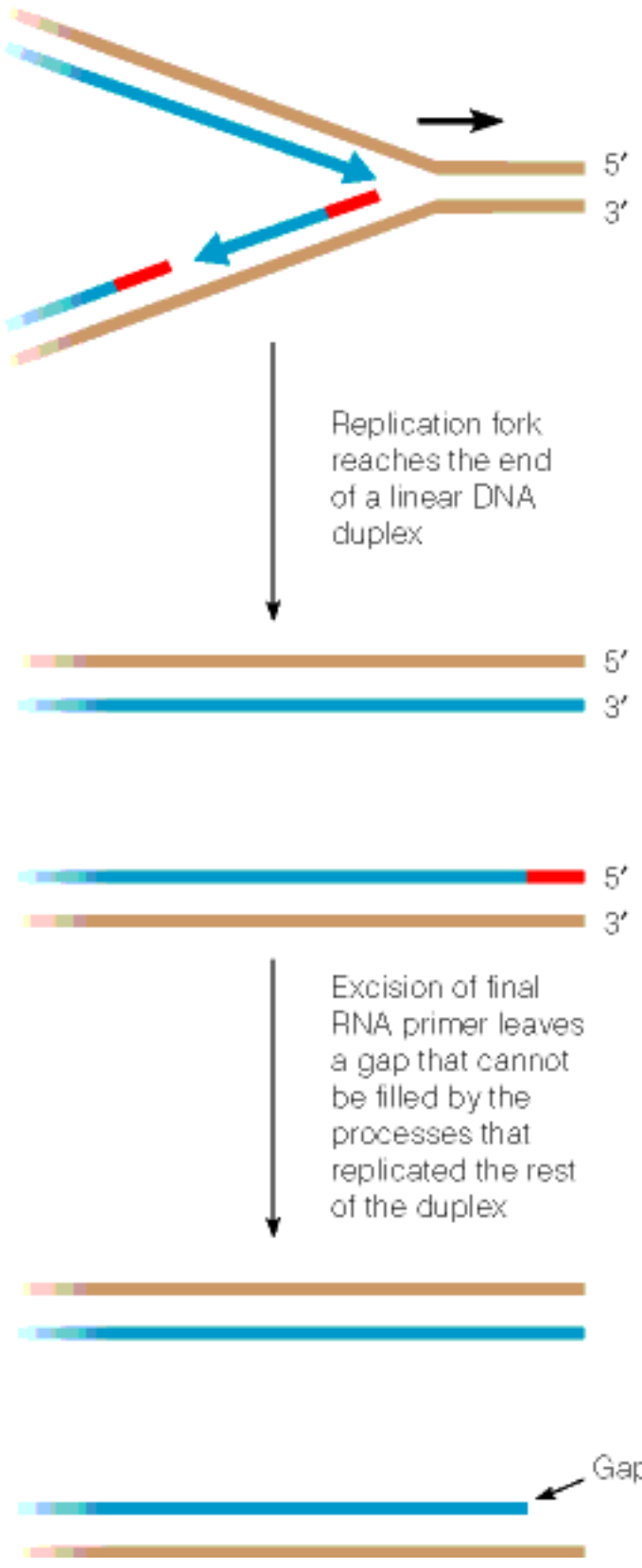
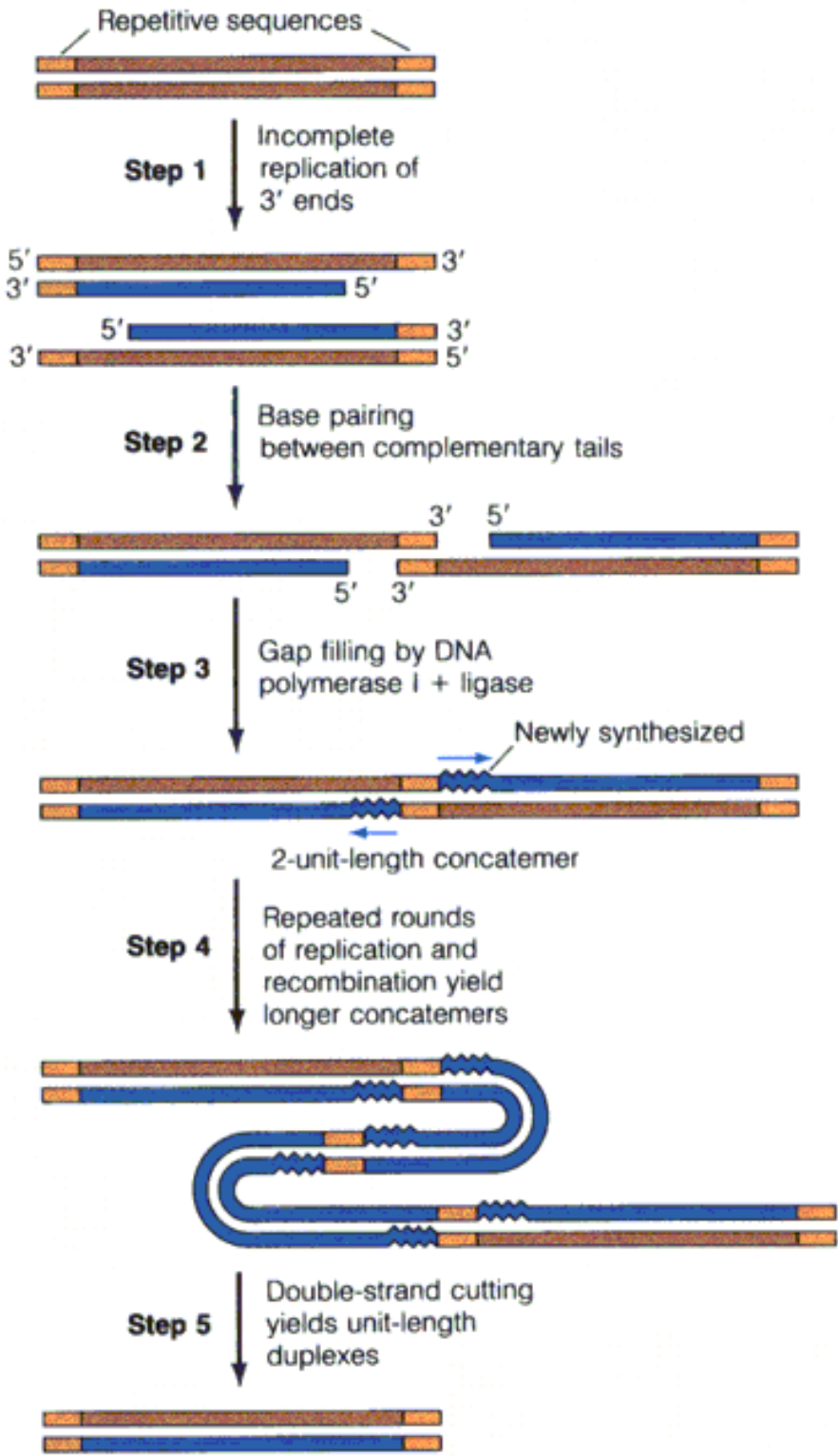
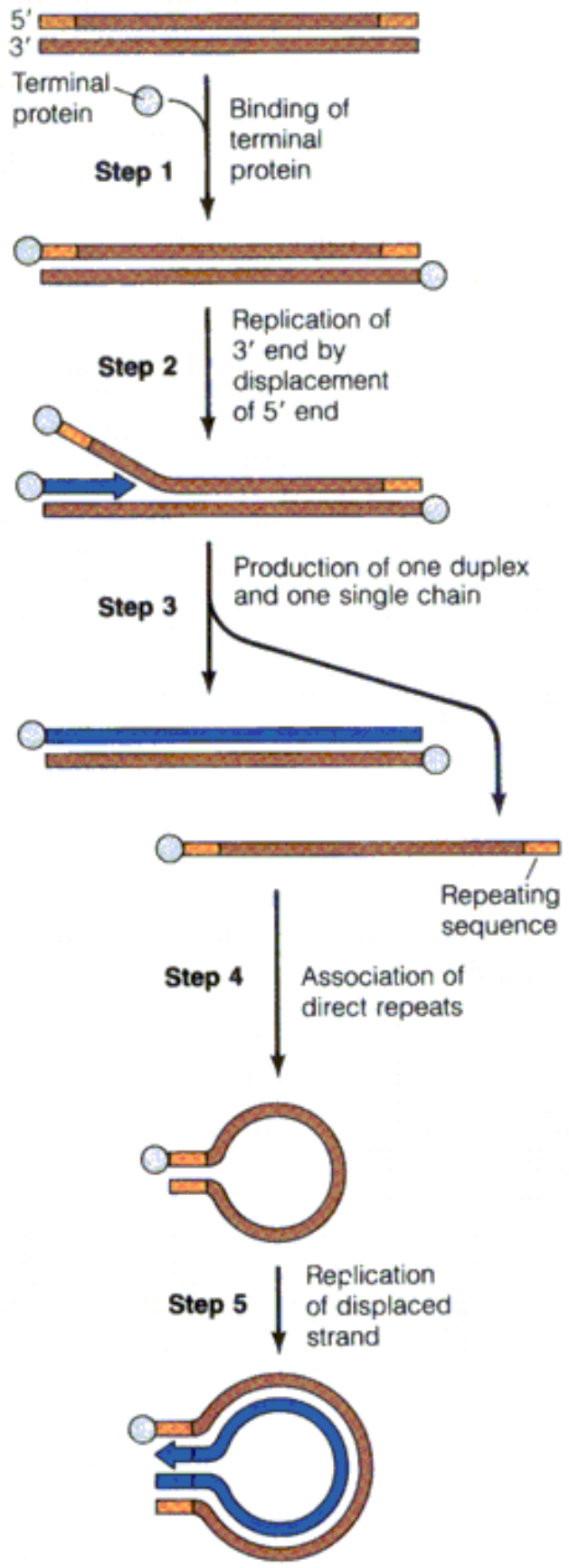

Figure 24.41a and 24.41b: Mechanisms for replication of linear DNAs.



(a)



(b)

Eukaryotic DNA Replication

Mechanisms - The basic mechanisms of **DNA replication** are quite similar in eukaryotes and prokaryotes. **DNA replication** is semiconservative and is continuous on one strand and discontinuous on the other. As in prokaryotes, eukaryotic replication entails the assembly of short RNA primer molecules, elongation from the primers by a **DNA polymerase**, and (on the discontinuous strand) ligation of Okazaki fragments. A significant difference in eukaryotic and prokaryotic DNA replication is in the smaller size of the Okazaki fragments in eukaryotic cells - about 135 bases long, or about the size of the DNA on a **nucleosome**.

Enzymes - Eukaryotic cells contain five DNA polymerases. Three of them (polymerases α , Δ , and ϵ) are used during S phase replication. **Table 24.2** and **Table 24.3** describe the properties of eukaryotic and prokaryotic DNA polymerases. As in prokaryotes, the replication complex also contains other proteins, including **helicases** and a number of accessory proteins called replication factors.

Assembly of Nucleosomes - Replication of the nuclear genome in eukaryotes presents some special problems. For example, the replication machinery must proceed through the complex nucleosomal structure of chromatin, which must apparently be dismantled and then reconstructed on the daughter DNA molecules as the replication machinery proceeds. Thus, not only must the DNA be faithfully copied, but also highly organized chromatin structure must be regenerated. It seems likely that nucleosomes from the parental chromatin strand are disassembled ahead of the replication fork and are then reassembled on one or the other of the daughter strands (**Figure 28.17**). Both preexisting and newly synthesized histones are used in the new nucleosomes. (H3/H4)₂ tetramers and H2A/H2B dimers tend to remain intact, but other mixing is random.

Origins of Replication - Complications in dealing with the protein component in chromatin may explain why the rate of motion of a replication fork is about 10-fold slower in eukaryotes than in prokaryotes (compare with **Table 24.1**). The slow rate of fork motion (about 75 nucleotides/second) combined with the enormous size of eukaryotic genomes (roughly 10^8 base pairs), requires eukaryotic chromosomes to have many **origins of replication**--as many as several thousand on each chromosome. Replication proceeds bidirectionally from these origins, creating the replication "bubbles" shown in **Figure 28.18**. These bubbles grow independently until they finally merge and the whole chromosome has been copied. There is a tendency for transcriptionally active regions to begin replication early, whereas inactive regions replicate later.

In yeast, sequences called autonomously replicating sequences (ARSs) have been recognized as essential for the replication of plasmids. ARS sequences are typically several hundred base pairs in length with subsequences carrying copies of an 11 bp consensus sequence, called ACS (5' TTTTATATTTT 3'), which is absolutely required for function. ARSs have binding sites for the six-polypeptide origin binding factor as well as a strong affinity for the nuclear matrix.

Telomeres - Eukaryotic cells deal with the problem of completing the lagging strand of their linear chromosomes by the addition of telomeres at the ends of each chromosome. **Telomeric** DNA consists of simple tandemly repeated sequences like those shown in [Table 28.2](#). Typically, one strand is G-rich, the other C-rich. These sequences are repeatedly added to the termini of chromosomal DNAs by enzymes called telomerases ([Figure 28.19](#)). This elongation allows room for a primer to bind and initiate synthesis on the other strand, maintaining the approximate length of the chromosome and preventing the loss of coding sequences. Telomerase must add nucleotides without the use of a DNA primer. This is probably accomplished through the existence, in each telomerase, of an essential RNA oligonucleotide that is complementary to the telomeric sequence being synthesized. **Telomeres** may have other important functions, too. For example, there is a strong correlation between aging, cell senescence, and low levels of telomerase. Conversely, cells in culture can be "immortalized" by introduction of active telomerase genes.

See also: [Molecular Control of the Cell Cycle](#), [The Cell Cycle](#), [Eukaryotic DNA Polymerases](#) (from Chapter 24)

INTERNET LINKS:

1. [The Telomere Club](#)
 2. [What are Telomeres?](#)
-

Figure 28.17: Model for chromatin replication.

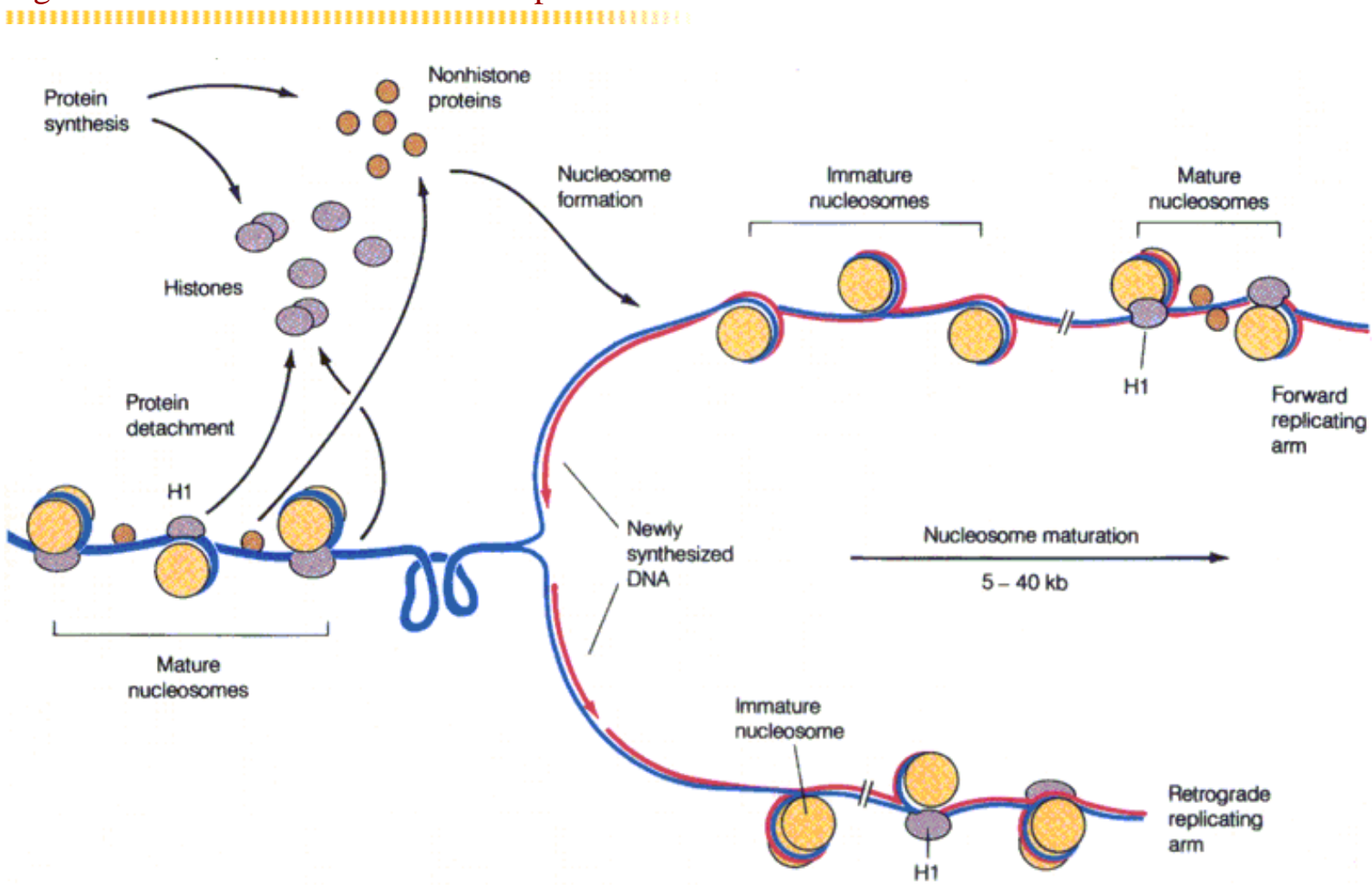

Table 24.1



	Replication Process	
	<i>E. coli</i>	Human
DNA content, number of nucleotide pairs per cell	3.9×10^6	ca. 10^9
Rate of replication fork progression, $\mu\text{m}/\text{minute}$	30	3
DNA replication rate, nucleotides/second per replication fork	850	60–90
Number of replication origins per cell	1	10^3 – 10^4
Hours required for complete genome replication	0.67	8
Hours required for one complete cell division	0.33	24

Note: The data are for an *E. coli* cell optimally nourished and cultured at 37°C. The values for human cells represent data from HeLa cells, which were originally derived from a tumor and have been maintained in culture for many years.

Figure 28.18: DNA replication in eukaryotes.

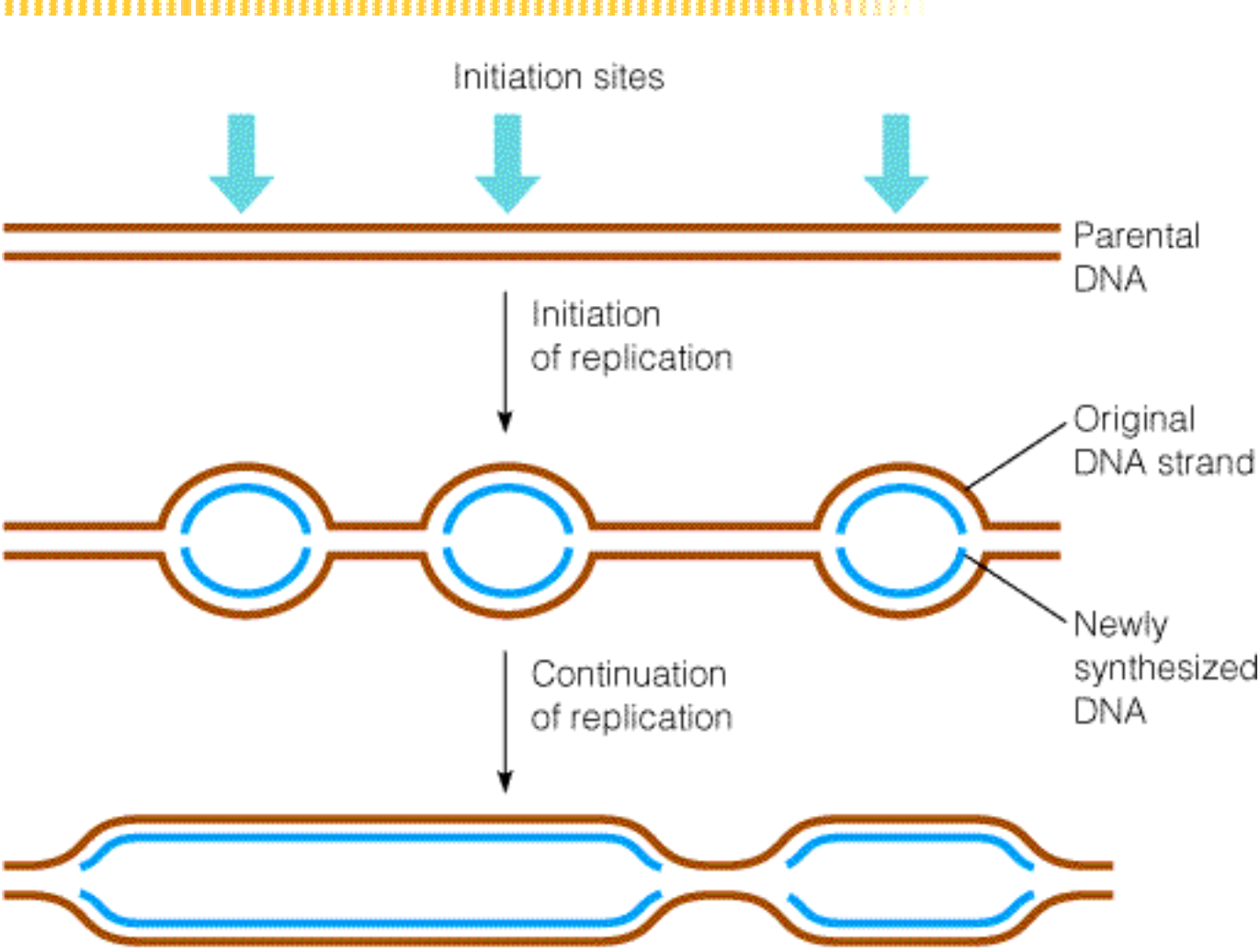

(b)

(a) Courtesy of S. L. McKnight and O. L. Miller, Jr.

Table 28.2

Organism	Repeat ^a
<i>Tetrahymena thermophila</i> (protist)	TTGGGG
<i>Saccharomyces cerevisiae</i> (yeast)	T(G) ₂₋₃ (TG) ₁₋₆ ^b
<i>Arabidopsis thaliana</i> (plant)	TTTAGGG
<i>Bombyx mori</i> (silkworm)	TTAGG
Human	TTAGGG

^a Written in 5'→3' direction.

^b Yeasts are unusual in having somewhat variable telomeric repeats.

Figure 28.19: Extension of telomeric DNA by telomerase.

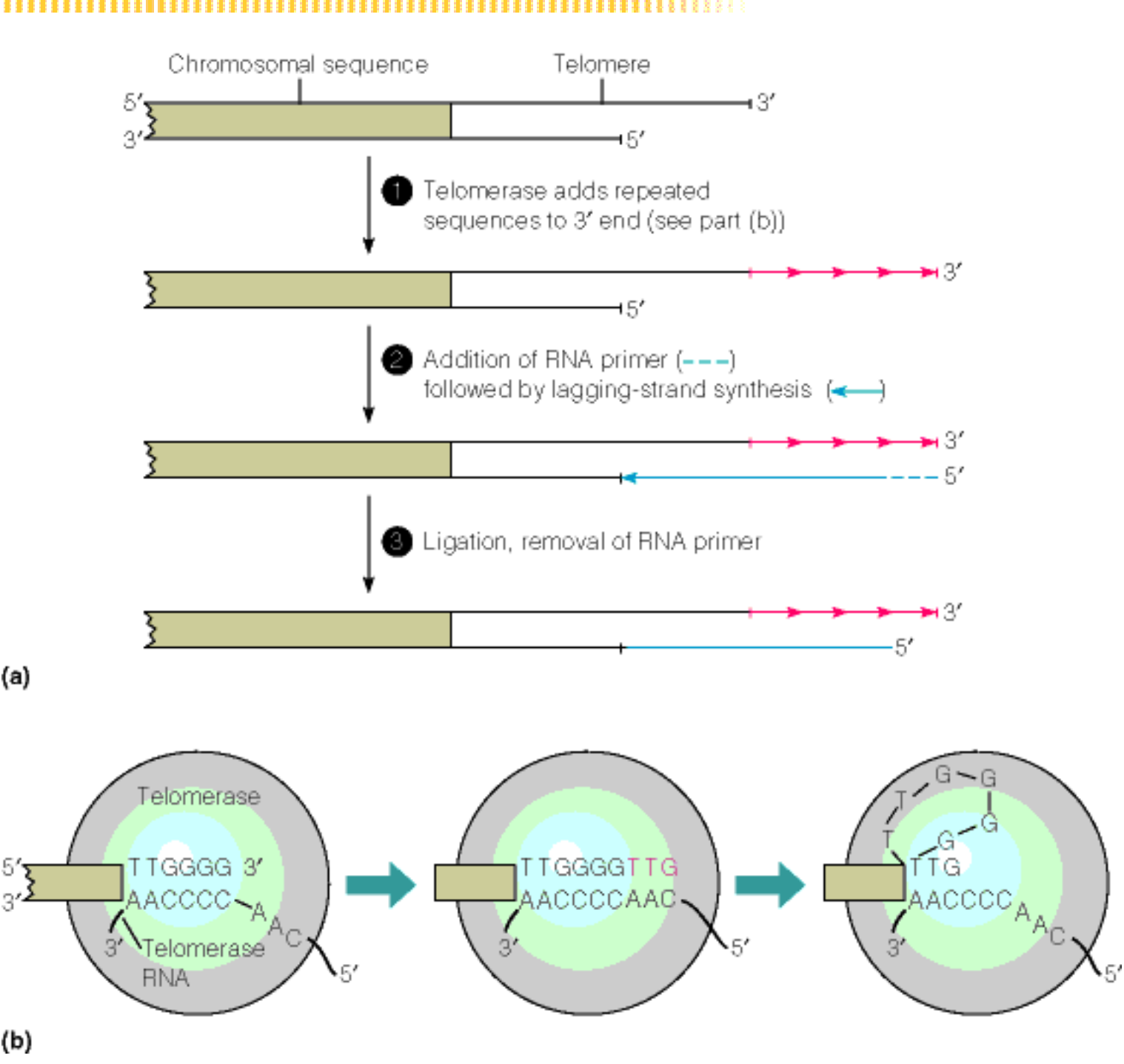

Molecular Control of the Cell Cycle

Phosphorylation control - The key process among the chemical events that trigger the successive stages of the cell cycle is the phosphorylation of a number of nuclear proteins (including histone H1). The key enzymes are a set of kinases.

Yeast control - cdc2 (from yeast) is a serine/threonine kinase whose activation requires association with specific small proteins called cyclins. In yeast, one cyclin activates cdc2 at the start of S phase, another reactivates it at the beginning of mitosis.

Cyclins/cyclin-dependent kinases in higher eukaryotes - In higher eukaryotes, there are several "cyclin-dependent kinases" and a number of cyclins to associate with them. Each transition in the cell cycle appears to have a unique cyclin/kinase complex as its trigger. A simplified view of the roles of these proteins in mammalian cells is shown in [Figure 28.16](#). The cyclin-dependent kinase CDK2 is involved in the entrance to S-phase, and cdc2, with cyclins A and B, regulates mitosis.

Control of the cell cycle triggers - The cell cycle triggers themselves are under strict control. Synthesis of cyclins is determined, at least in part, by growth hormones. cdc2 is phosphorylated at entry to the G2 phase, but must be dephosphorylated for mitosis to continue. If DNA is damaged or replication forks are stalled, dephosphorylation of cdc2 is prevented and this stops mitosis. This is a so-called checkpoint for the cell cycle.

Second checkpoint - Another checkpoint occurs when the protein [p53](#) detects DNA damage. When damage is detected, p53 activates transcription of the gene *PicI*, the product of which binds to CDCKs, blocking the cell in the G1 phase and frequently leading to apoptosis. If p53 is unable to function, potentially cancerous cells with damaged DNA will be able to replicate.

See also: [The Cell Cycle](#), [Apoptosis](#)

INTERNET LINK: [Regulation of the Cell Cycle](#)

Figure 28.16: The roles of kinases and cyclins in regulating the cell cycle.

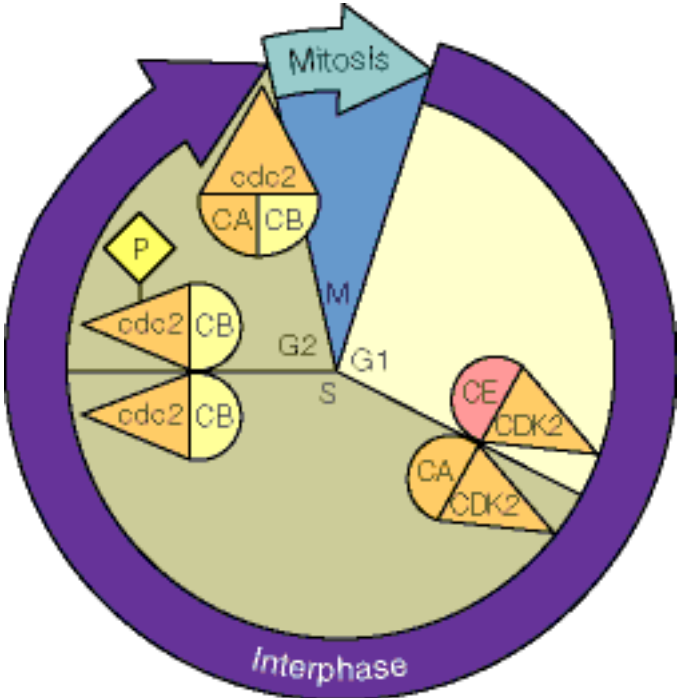

p53

Tumor suppressors are genes that result in tumor formation after suffering a mutation that destroys their normal function. **p53** (a protein of 53 kilodaltons) is an important tumor suppressor gene.

Loss of **p53** function leads to tumorigenesis, and a large fraction of human tumors examined display **p53** gene mutations. Although its biochemical actions are not yet clear, **p53** is a DNA-binding protein that plays a role in regulating the [cell cycle](#), preventing inappropriate movement of G1 cells into S phase. Loss of such a checkpoint could lead to the loss of cell growth control associated with cancer.

Binding to specific DNA sequences is essential for the proper functioning of p53. This was revealed in 1994 when the structure of the DNA-binding domain in contact with an oligonucleotide containing the binding sequence was determined by x-ray crystallography. Of great interest is that the amino acid residues in closest contact with DNA are those that have been shown most often to be changed in **p53** mutant genes isolated from human tumors.

See also: [Viral and cellular oncogenes](#), [oncogenes and cell signalling](#), [Oncogenes](#), [Oncogenes in Human Tumors](#)

INTERNET LINKS:

1. [p53 Tumor Suppressor Protein](#)
 2. [Tumor Suppressor Genes](#)
 3. [Tumor Suppressor Genes and Cancer Treatment](#)
-

The Cell Cycle

Eukaryotic cell cycle - The processes by which cells divide and DNA is replicated (see [here](#)) are somewhat more complicated in eukaryotes than in prokaryotes. DNA replication in bacteria is an almost continuous process, at least during exponential growth. The somatic cells of eukaryotes, on the other hand, typically divide much less frequently, and some, in certain types of mature tissue, do not divide at all. Eukaryotic cells that are dividing in growing tissues exhibit a well-defined cell cycle, which is almost always separated into several distinct phases, as shown in [Figure 28.14](#), [Figure 28.15](#), and [Figure 28.16](#).

The **eukaryotic cell cycle** proceeds as follows:

1. The G1 phase (or first gap phase), follows cell division. In the G1 phase, the cell contains two copies of each chromosome ("2C" in [Figure 28.14](#)); that is, the cell is in the diploid state.
2. Late in the G1 phase, the commitment to divide is triggered in an as yet unknown fashion. Because division first requires doubling of the DNA content, and the new DNA needs new [histones](#) to make [chromatin](#), synthesis of histones is one of the first indications of incipient DNA replication (see [Figure 28.14](#)).
3. The cell then enters synthesis, or S phase. During this stage, the DNA is replicated and the histones and nonhistone proteins are deposited on the daughter DNA molecules to reproduce the chromatin structures.
4. When replication is complete, the cell enters the G2 phase. It has a DNA content four times the haploid amount (4C). In most eukaryotic cells, the total time required for G1, S, and G2 phases will be many hours. During this whole period, which is termed **interphase**, the chromatin is dispersed throughout the nucleus and is actively engaged in transcription.
5. At the end of G2, the cell is ready to begin to divide (mitosis). Mitosis has been subdivided for descriptive purposes into the phases depicted in [Figure 28.15](#).

Prophase - In prophase, the replicated chromosomes condense into the typical metaphase chromosome structures so often pictured. The nuclear membrane disintegrates, and the mitotic spindle forms. The spindle consists of contractile microtubules that pull pairs of chromatids apart so that the daughter cells will each receive identical sets of chromosomes.

Metaphase - Each chromosome aligns independently at the metaphase plate.

Anaphase - Sister chromatids separate to opposite poles of the cell in anticipation of cell division.

Telophase - The nuclear membrane then re-forms about each daughter nucleus.

Cytokinesis - The cell divides. After division, the chromosomes of the daughter cells disperse, and a new G1 phase begins.

In many tissues of higher organisms, the G1 phase becomes very prolonged after growth and tissue differentiation are complete. The most extreme examples are fully differentiated nerve cells, most of which never divide again in mature organisms. Nondividing cells in a permanently arrested G1 phase are said to be in G0 phase. On the other hand, some specialized stem cells, such as those found in the bone marrow and intestinal epithelium, undergo continuous division throughout the life of the organism.

See also: [Molecular Control of the Cell Cycle](#), [Eukaryotic DNA Replication](#), [Apoptosis](#)

INTERNET LINK: [Regulation of the Cell Cycle](#)

Figure 28.14: The eukaryotic cell cycle.

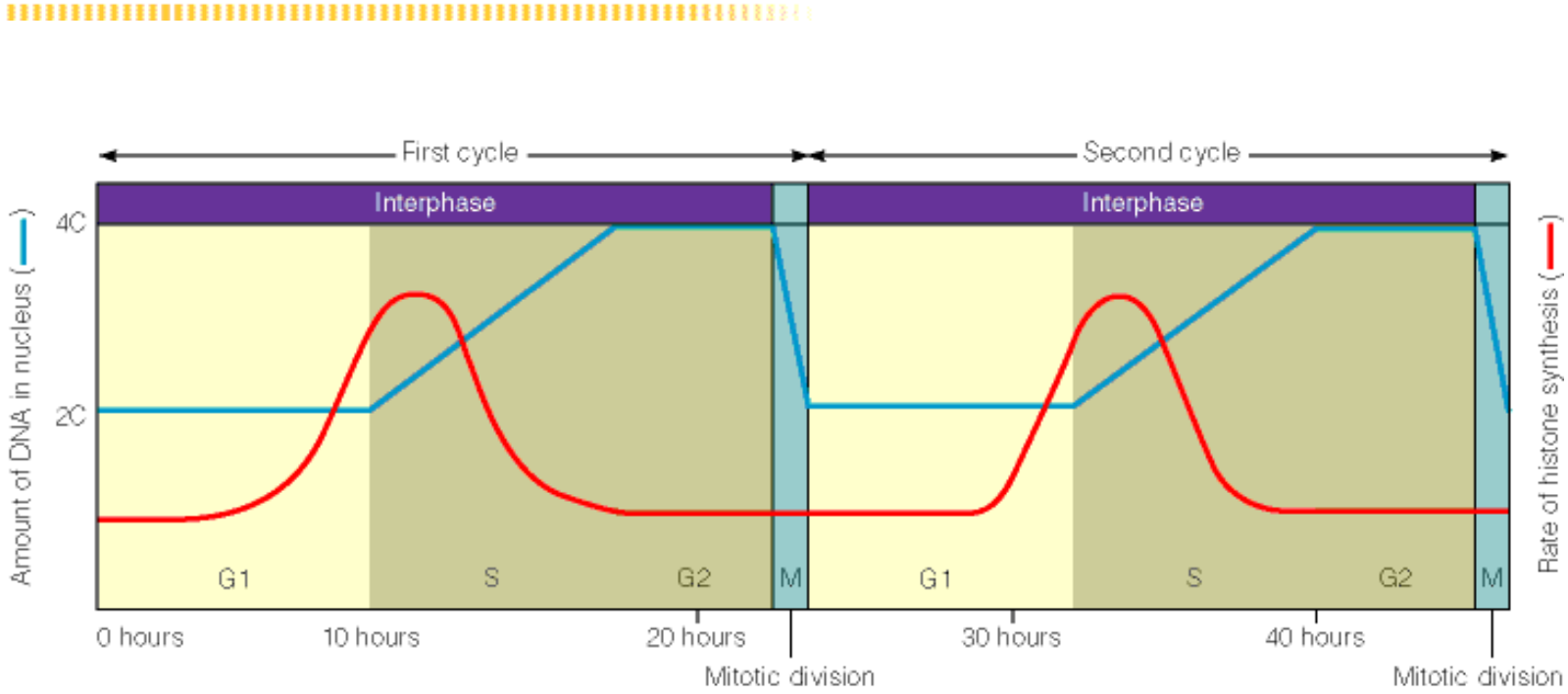
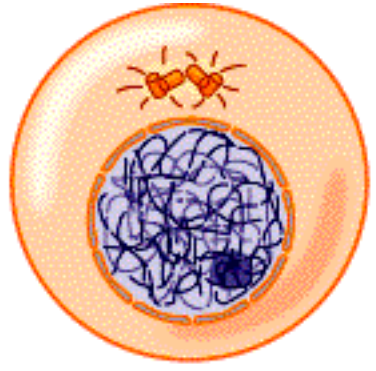
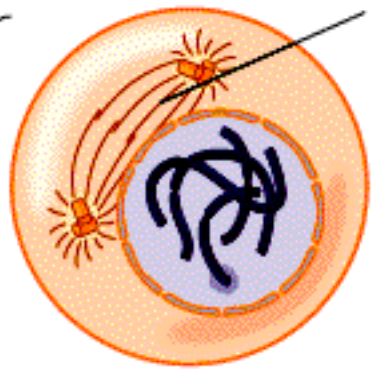

Figure 28.15: Mitosis.

Interphase:
DNA replicates



Prophase:
Chromosomes condense, the spindle forms, and the nuclear envelope disintegrates



Mitotic spindle

Each chromosome has two chromatids

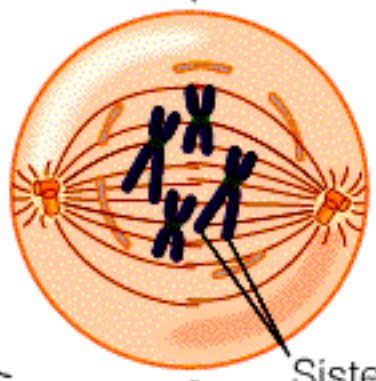

Sister chromatids

Metaphase:
Each chromosome aligns independently at the metaphase plate

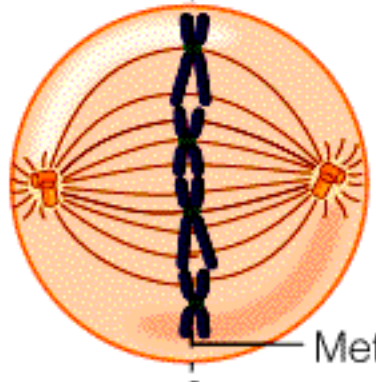

Metaphase plate



plate

Anaphase:
Chromatids separate

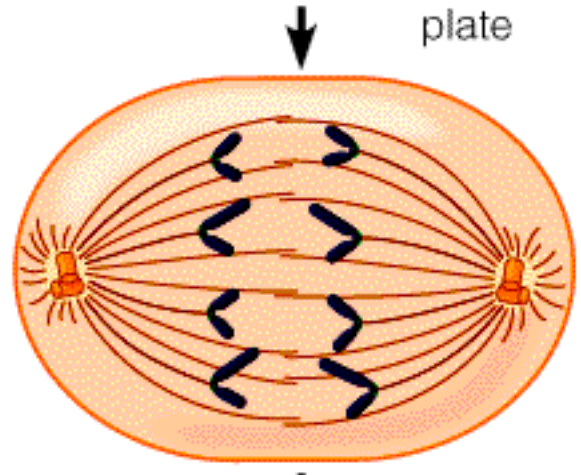

Telophase and cytokinesis:
The nuclear envelope reforms and the cell now divides (cytokinesis)

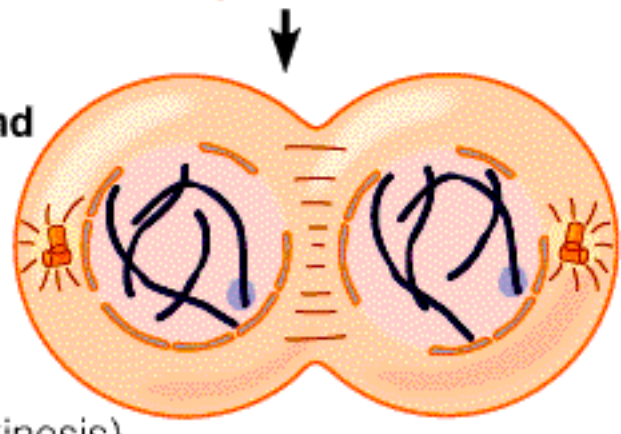

Apoptosis

Need for apoptosis - Many organisms exhibit a process of programmed cell death called **apoptosis**. There are many needs for this process. During development in the growing embryo, tissues present at one stage must be removed as development proceeds - for example, the "webbing" that humans have between fingers at a certain point in fetal life. Also, in adults, damaged, imperfect, or infected cells need to be removed for the health of the organism.

Caspase cascade - The **caspases** are proteases that all cleave to the carboxyl side of aspartate (c-asp-ase) and are all synthesized as inactive precursors that can be activated by just such a cleavage. Thus, there is the possibility of a **caspase cascade**, once activation is triggered. There are a large number of potential cytoplasmic, mitochondrial, and extracellular triggers of **caspases**. These include interferon and tumor necrosis factor, a protein long known to inhibit tumor growth by interaction with cell surface receptors. The latter have been implicated in **caspase** activation. Once the **caspase cascade** has started, destruction is wholesale. The proteins known to be cleaved by **caspases** cover a wide range, from structural proteins (like actin and nuclear lamin) to **transcription factors** and splicing factors (see [here](#)). Nucleases are activated to digest the cell's DNA. The cell disintegrates into fragments that are recognized by phagocytes and fully destroyed.

See also: [Eukaryotic DNA and Development](#), [Oncogenes in Human Tumors](#) (from Chapter 23), [p53](#)

INTERNET LINKS:

1. [Apoptosis Resource Guide](#)
 2. [Apoptosis](#)
-

Eukaryotic DNA and Development

DNA information - The life of the eukaryotic organism is carefully programmed in its DNA, but eukaryotic DNA is more than simply the recipes for proteins and special nucleic acids. Special signals hidden within the genes determine how transcripts will be cut and spliced, where gene products will go, and even how long they will last. In addition, a vast amount of information, usually coded in the sequences surrounding certain genes, specifies when, either in the course of development or in response to environmental stresses, certain genes are to be transcribed.

Elaborate programming - At a higher level, further genetic instructions coordinating these transcriptional instructions must exist, because the development of an organism requires the programmed differentiation of some cells, the proliferation of certain tissues, and the death of selected cells.

Developmental changes - Much of what is known about development comes from study of the fruit fly *Drosophila melanogaster*. As the larva of this insect develops, groups of cells are set apart as disklike structures called imaginal disks ([Figure 28.45](#)). These groups of cells will form specific parts of the adult fly. As the larva metamorphoses, larval cells are destroyed by autolysis, and each imaginal disk develops into a different portion of the adult.

Homeotic gene control - Geneticists working with *Drosophila* have long recognized classes of **homeotic** mutations-mutations that scramble the whole developmental pattern in defined ways. One, called the *Antennapedia* mutation, causes perfectly formed legs to grow in the places near the eye where antennae are normally formed. Another group, called *bithorax* mutations, leads to abnormal development of thoracic segments, producing, for example, extra pairs of wings. Large clusters of **homeotic** genes control these developmental processes and are the sites of **homeotic** mutations. A common sequence element, called the **homeo box**, has about 180 bp and is repeated many times in these gene clusters. The **homeo box** codes for a 60-residue polypeptide sequence called the **homeo domain**. Proteins containing this domain are nuclear, DNA-binding proteins of the helix--loop--helix class (see [here](#)). It seems likely that each acts as a regulator of transcription for a coordinated group of proteins.

Other Homeo Boxes - The **homeo box** is found in many other organisms, including amphibians and mammals, with sequences remarkably conserved over this phylogenetic range.

See also: [Apoptosis](#)

Figure 28.45: Imaginal disks in the development of *Drosophila*

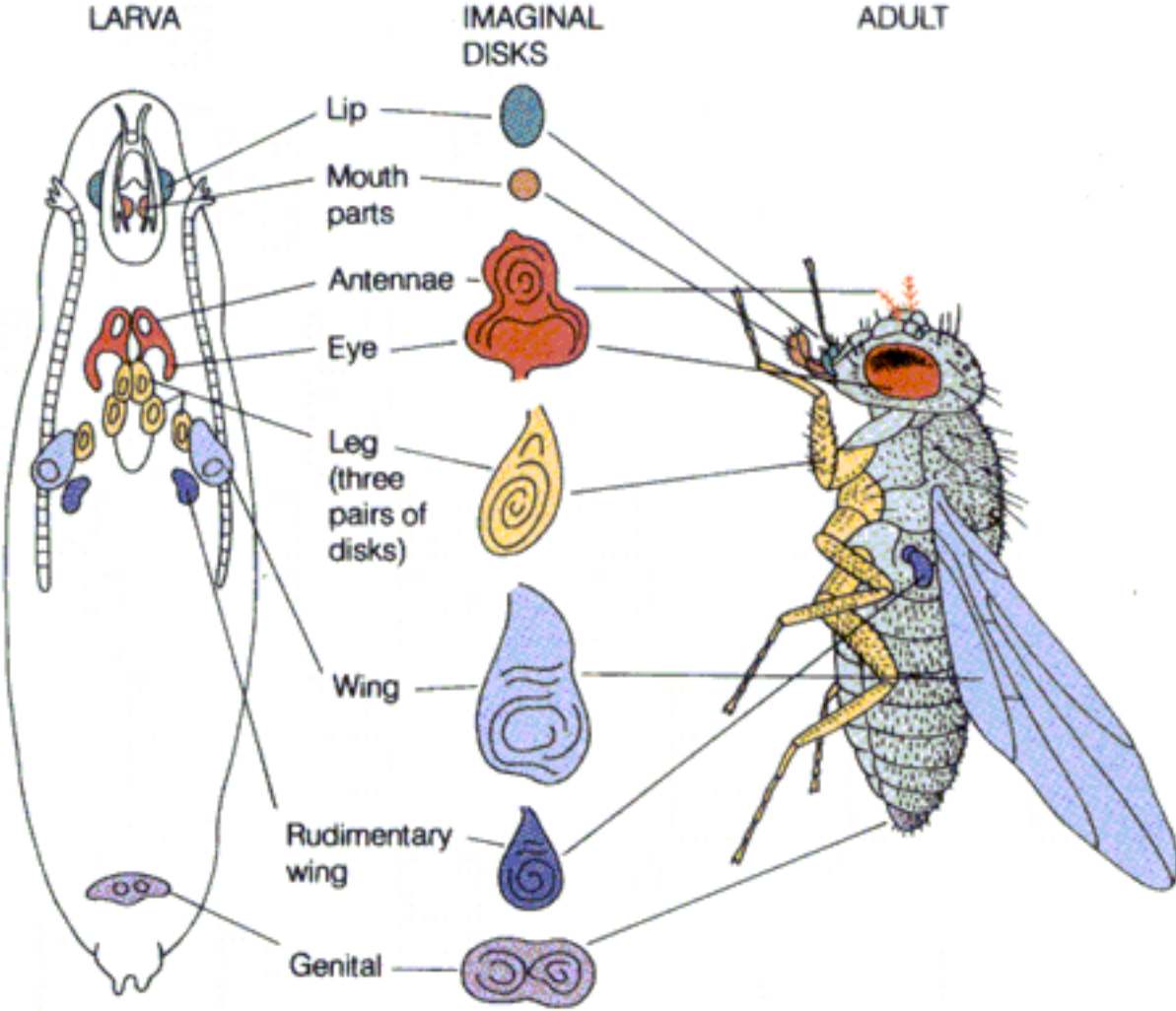

Imaginal disks in the development of *Drosophila*.

Oncogenes in Human Tumors

Ras genes encode a family of proteins (all of about 21 kilodaltons) with regions homologous to sequences in the α subunit of G proteins (see [here](#)). Like the α subunit, the Ras proteins bind guanine nucleotides. Normal Ras proteins possess a GTPase activity, as do G proteins, whereas most *ras* oncogene proteins lack this activity (by convention, the name of the gene is italicized, and the corresponding protein is not). The GTPase activity suggested that normal Ras proteins function like G proteins in regulating metabolism. A mutation in the twelfth codon of the human *ras* **oncogene** that changes a [glycine](#) codon to a [valine](#) codon eliminates the protein's ability to hydrolyze [GTP](#) to [GDP](#). In 1988, the three-dimensional structure of a Ras protein, crystallized with GDP was determined. Amino acid residues known to be changed in mutations that generate *ras* **oncogenes** are positioned close to the bound guanine nucleotide. This positioning supports the idea that interactions between the proto-oncogene Ras protein and guanine nucleotides are important to metabolic control and that this control is lost when a normal cell is transformed to a cancer cell.

A major difference between Ras-type proteins and the related G_{α} proteins is the far higher GTPase activity of the G_{α} proteins. A set of Ras-activating proteins is required to stimulate the GTPase activity of Ras. G_{α} , but not Ras, proteins contain a conserved arginine residue (R178), which stabilizes the negative charge on the α phosphate of bound GTP.

Research on **oncogenes** has led to unifying theories of carcinogenesis. The great majority of chemical carcinogens are also mutagens. Chemical carcinogenesis involves mutagenesis of cellular **proto-oncogenes**, events that can occur in the absence of exogenous viruses (mechanism 2 in [Figure 23.19](#)). Indeed, *ras* genes altered in codon 12 have been detected in a variety of spontaneous and chemically induced tumors, in both animals and humans.

Other genetic alterations that lead to tumors involve **antioncogenes**, or tumor suppressor genes. Unlike **proto-oncogenes**, these are genes that in the normal form suppress cell division. Loss of normal gene function leads to tumor formation. One of these genes is called the retinoblastoma gene. Mutations in the two alleles of this gene cause a type of eye tumor.

The other most prominent tumor suppressor gene encodes a protein called [p53](#) (a protein of 53 kilodaltons). Loss of p53 function leads to tumorigenesis, and a large fraction of human tumors examined display p53 gene mutations. Although all its biochemical actions are not yet clear, p53 is a DNA-binding protein that plays a role in regulating the [cell cycle](#), preventing inappropriate movement of G1 cells into S phase. Loss of such a checkpoint could result in the loss of cell growth control associated with cancer.

Binding to specific DNA sequences is essential for the proper functioning of p53. This was revealed in 1994 when the structure of the DNA-binding domain in contact with an oligonucleotide containing the binding sequence was determined by x-ray crystallography. Of great interest is that the amino acid

residues in closest contact with DNA are those that have been shown most often to be changed in p53 mutant genes isolated from human tumors.

About a dozen **antioncogenes** had been identified. Mutations affecting most of these genes have been detected in the germ line of human cells and have been correlated with the predisposition to become afflicted with certain forms of cancer.

See also: [Viral and Cellular Oncogenes](#), [Oncogenes and Cell Signalling](#), [G Proteins and Signal Transduction](#), [G Protein Families and Subunits](#)

INTERNET LINKS:

1. [p53 Tumor Suppressor Protein](#)
 2. [Tumor Suppressor Genes](#)
 3. [Tumor Suppressor Genes and Cancer Treatment](#)
-

Ras

Ras genes encode a family of proteins (all of about 21 kilodaltons) with regions homologous to sequences in the α subunit of G proteins (see [here](#)). Like the α subunit, the **Ras** proteins bind guanine nucleotides. Normal **Ras** proteins possess a GTPase activity, as do G proteins, whereas most *ras* oncogene proteins lack this activity (by convention, the name of the gene is italicized, and the corresponding protein is not). The GTPase activity suggested that normal **Ras** proteins function like G proteins in regulating metabolism. A mutation in the twelfth codon of the human *ras* oncogene that changes a [glycine](#) codon to a [valine](#) codon eliminates the protein's ability to hydrolyze [GTP](#) to [GDP](#). In 1988, the three-dimensional structure of a **Ras** protein, crystallized with GDP was determined. Amino acid residues known to be changed in mutations that generate *ras* **oncogenes** are positioned close to the bound guanine nucleotide. This positioning supports the idea that interactions between the proto-oncogene **Ras** protein and guanine nucleotides are important to metabolic control and that this control is lost when a normal cell is transformed to a cancer cell.

A major difference between **Ras**-type proteins and the related G_{α} proteins is the far higher GTPase activity of the G_{α} proteins. A set of **Ras**-activating proteins is required to stimulate the GTPase activity of **Ras**. G_{α} , but not **Ras**, proteins contain a conserved arginine residue (R178), which stabilizes the negative charge on the α phosphate of bound GTP.

The **Ras** protein occupies a central role in directing extracellular signals to the nucleus, where specific genes are activated for cell growth, division, and differentiation. **Ras**-related proteins have been discovered in such diverse organisms as yeast, nematode worms, and *Drosophila*, in which they control aspects of mitotic and meiotic growth and embryonic development. Research on these organisms has illuminated a central control pathway in mammalian cells ([Figure 23.23](#)), in the process richly justifying the use of simple biological model systems for cancer research.

Many growth factor receptors with [tyrosine kinase](#) activity phosphorylate themselves (steps 1 and 2 in [Figure 23.23](#)). In the phosphorylated state, each receptor interacts with one or more protein exchange factors, which in turn activate **Ras** by stimulating the [GDP-GTP](#) exchange (step 3). Also interacting with **Ras**, and limiting its activity, are proteins called LGAPs (GTPase-activating proteins). **Ras** activates a cascade of further protein phosphorylations (step 4), which ultimately activates transcription factors (step 5). These factors interact with the genome and stimulate the expression of particular genes (see [here](#) and [here](#)).

See also: [Viral and Cellular Oncogenes](#), [Oncogenes in Human Tumors](#), [Oncogenes and Cell Signalling](#)

INTERNET LINKS:

1. [Tumor Gene Database](#)
 2. [Ras](#)
-

G Protein Families and Subunits

Figure 23.12 depicts the subunit structure of **G proteins** and their interactions, as affected by **GTP** and **GDP**. Several different forms of each **G protein** are known. In most forms, the γ subunit is prenylated (covalently bound to a 20 carbon isoprenoid moiety at the C-terminal cysteine). The α subunit is covalently linked to **myristic acid** and is the subunit that contains both the guanine nucleotide-binding site and the GTPase activity.

Binding of GTP by the α subunit causes it to dissociate from the other subunits and bind to **adenylate cyclase**. When GTP is hydrolyzed in the α subunit, however, it dissociates from adenylate cyclase and reassociates with the other subunits.

Cholera and pertussis toxins catalyze the covalent addition of ADP-ribose to specific sites in the α subunits of **Gs** and **Gi**, respectively. This modification inhibits GTPase action in the α subunits and converts them to irreversible activators of adenylate cyclase. As a result, cAMP accumulates. In the intestine, the response to this is an uncontrollable secretion of water and sodium--causing severe diarrhea and dehydration.

At least four different α subunits, five β subunits, and 6 γ subunits are known, allowing for a large number of **G proteins** to be made from these combinations. **Table 23.4** summarizes some of the properties of different **G proteins**.

The α subunits of G proteins are part of a family of small GTP-binding proteins that are active when GTP is bound and inactive in the presence of GDP. This includes the Ras oncogene proteins (see [here](#)) and the GTP-binding elongation factors in protein synthesis (see [here](#)).

See also: [G Proteins and Signal Transduction](#), [G proteins in vision](#), [Signal Transduction Agonists and Antagonists](#)

INTERNET LINKS:

1. [G Protein Receptor Coupled Database](#)
 2. [G Protein Coupled Receptors Point Mutation Database](#)
-

Myristic Acid (Myristate)

Myristic acid is a saturated fatty acid containing fourteen carbons.

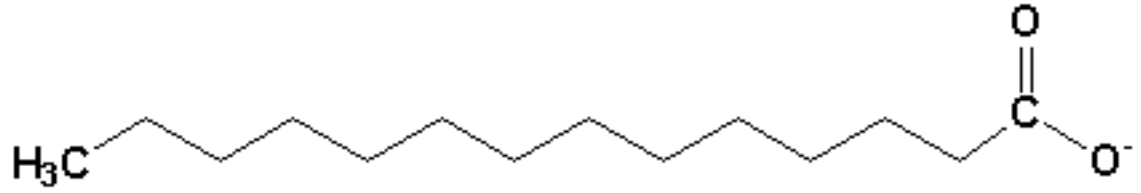

Myristate

See also: [G Protein Families and Subunits](#)

Table 23.4



Family	Toxin Sensitivity	Tissue Distribution	Receptors	Effectors
G _s	Cholera	Ubiquitous	β-adrenergic Glucagon Thyrotropin-releasing hormone	Adenylate cyclase Ca ²⁺ channels Na ⁺ channels
G _{olf}	Cholera	Olfactory epithelium	Odorant	Adenylate cyclase
G _i	Pertussis	Ubiquitous	M ₂ -cholinergic α ₂ -adrenergic	K ⁺ channels Ca ⁺ channels Adenylate cyclase Phospholipase C
Transducin (G _t)	Cholera, pertussis	Retinal rods	Rhodopsin	cGMP phosphodiesterase
G _q	?	Nearly ubiquitous	M ₁ -cholinergic α ₁ -adrenergic	Phospholipase C
G ₁₂	?	Ubiquitous	?	?
G _o	?	?	M ₂ -cholinergic	Ca ²⁺ channels

Source: Adapted from J. R. Hepler and A. G. Gilman, *Trends Biochem. Sci.* (1992) 17:384. © 1992 with permission of Elsevier Science.

Figure 23.23: Role of Ras protein in a central growth factor activation pathway.

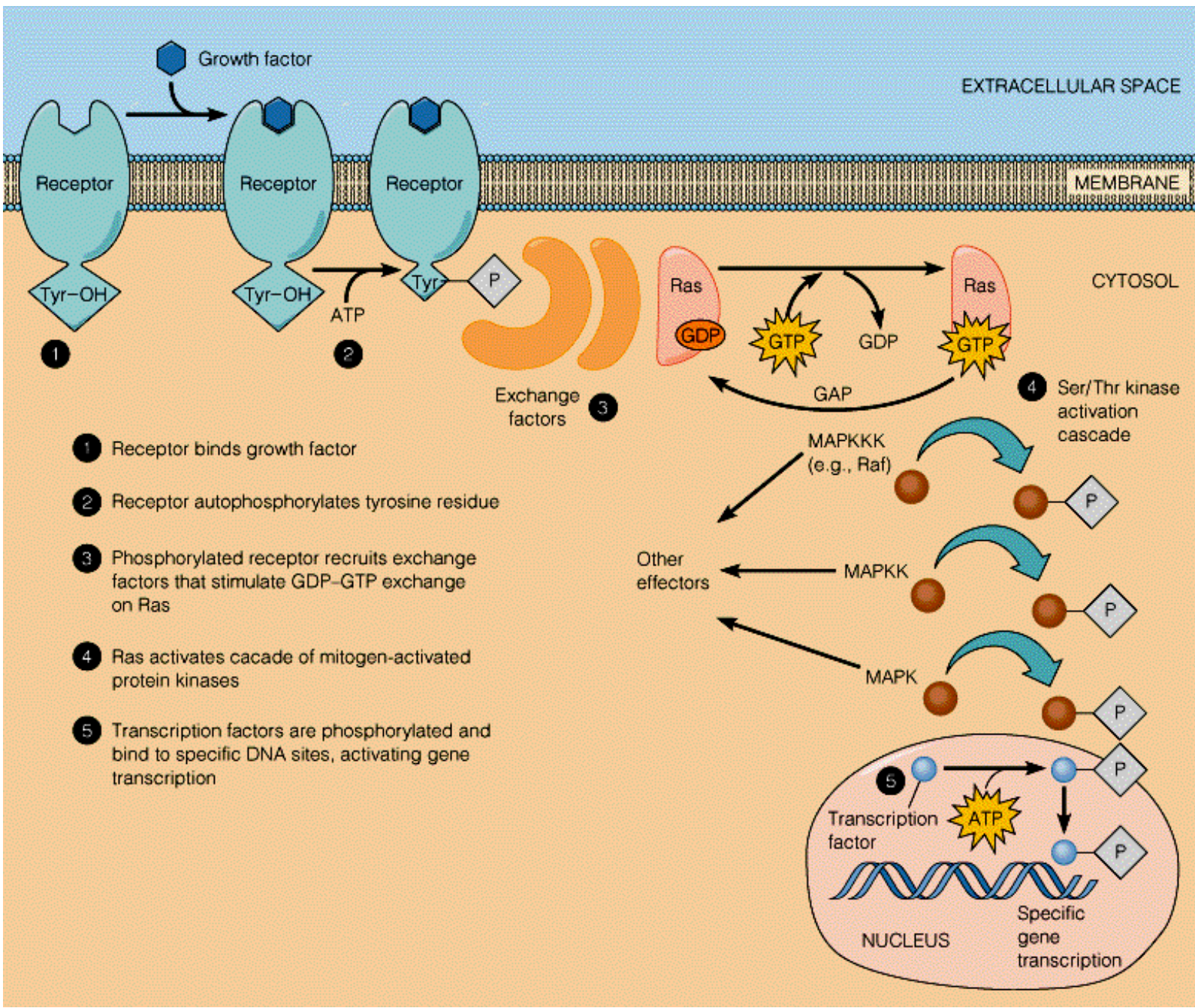

Adapted from S. E. Egan and R. A. Weinberg, Nature (1993) 365:782. © 1993 Macmillan Magazines, Ltd.

Viral and Cellular Oncogenes

In a wide variety of tumor cells, mutation alters forms of proteins involved in signal transduction. These include the following:

- Protein kinases;
- G proteins;
- Nuclear receptors;
- Growth factors; and
- Growth factor receptors.

Some tumor cells contain normal signal transduction proteins, but in excessive amounts. Genes responsible for altering cells to a cancerous state are called **oncogenes**. Investigations of protein products of **oncogenes** (**oncoproteins**) have shown how the normal forms of these genes (**proto-oncogenes**) regulate cell metabolism and growth and have shown how normal control mechanisms go awry in a cancer cell.

The following features are common in viral infections leading to cancer:

1. Cells become transformed. That is, they lose normal growth control mechanisms, and in cell culture they continue to proliferate under conditions that arrest the growth of normal cells.
2. The transformed cells are themselves tumorigenic; injecting them into animals causes tumors.
3. Part or all of the viral genome becomes linearly inserted into chromosomes of transformed cells. For RNA viruses like Rous sarcoma virus, the viral genome must be converted to double-strand DNA before this insertion can occur. The viral enzyme that synthesizes DNA from a single-strand RNA template is called **reverse transcriptase**, and viruses containing reverse transcriptase are called retroviruses (see [here](#)).

The viral **oncogene** in Rous sarcoma virus responsible for transforming infected cells from nontumorigenic to tumorigenic is called *src*. The cellular, unmutated form of *src* is a protein with a protein **tyrosine kinase** activity. Thus, a specific enzyme activity, which might be associated with signal transduction, was also associated with the **oncogene** product. Viral **oncogenes** most likely have their origins in normal cellular genes. One way to explain the transfer of an oncogene, or **oncogene** precursor, from cells to viruses, is to postulate a rare genome excision event, as depicted in [Figure 23.19](#). If an infection had caused insertion of the viral genome next to an **oncogene** precursor (or **proto-oncogene**), and if a subsequent excision event removed part or all of the **proto-oncogene**, as well as the viral genome, then this faulty excision would have created a novel viral genome containing a cellular gene.

Subsequent evolution of the virus could change the cellular gene, creating an **oncogene**.

Sequence analysis of the *src* gene from viruses and cells revealed small differences between the two. Thus, *v-src*, refers to the viral form of the gene and *c-src* to the cellular form. Analysis of many other tumor viruses yielded more than two dozen additional **oncogenes**. The corresponding **proto-oncogenes** encode a variety of proteins involved in cell signaling, some of which are identified in [Table 23.7](#).

Further analysis of infections leading to tumorigenesis showed that mutational alteration of the **proto-oncogene** is not always necessary. In some cases the viral genome is inserted adjacent to a **proto-oncogene**. Elements of the viral genome stimulate transcription of the DNA sequences flanking the integration site. Thus, tumorigenesis can result from overexpression of normal genes encoding signal transduction machinery.

See also: [Oncogenes in Human Tumors](#), [Oncogenes and Cell Signalling](#)

INTERNET LINK: [Tumor Gene Database](#)

Oncogenes

Oncogenes are altered (mutated) cellular genes associated with cellular transformation and cancer ([Table 23.7](#)). The unmutated cellular form of an oncogene is called a **proto-oncogene**. **Proto-oncogenes** can act as **oncogenes** too if a mutation controlling the expression of that particular gene affects either the amount or timing of the gene's expression. **Oncogenes** transferred to a cell by a virus are called viral **oncogenes**. Viral **oncogenes** are usually mutated forms of normal cellular genes that probably arise from rare genome excision events ([Figure 23.19](#)).

Oncogenes can be placed into several categories, as follows:

1. Protein kinases;
2. G proteins;
3. Nuclear receptors;
4. Growth factors;
5. Growth factor receptors; and
6. Tumor Suppressors.

See also: [Oncogenes in Human Tumors](#), [Oncogenes and Cell Signalling](#)

INTERNET LINK: [Tumor Gene Database](#)

Table 23.7



Signal Transduction Element	Oncogene	Isolated from	Gene Product
Growth factors	<i>sis</i>	Retrovirus	Platelet-derived growth factor
Growth factor receptors	<i>erbB</i> , <i>neu</i>	Retrovirus	Epidermal growth factor receptor
	<i>fms</i>	Retrovirus	Colony-stimulating factor 1 receptor
	<i>trk</i>	Tumor	Nerve growth factor receptor
	<i>ros</i>	Retrovirus	Insulin receptor
	<i>kit</i>	Retrovirus	PDGF receptor
Intracellular transducers	<i>flg</i>	Retrovirus	Fibroblast growth factor receptor
	<i>src</i>	Retrovirus	Protein tyrosine kinase
	<i>abl</i>	Retrovirus	Protein tyrosine kinase
	<i>raf</i>	Retrovirus	Protein serine kinase
	<i>gsp</i>	Tumor	G protein α subunit
Nuclear transcription factors	<i>ras</i>	Tumor, retrovirus	GTP/GDP-binding protein
	<i>jun</i>	Retrovirus	Transcription factor (AP-1)
	<i>fos</i>	Retrovirus	Transcription factor (AP-1)
	<i>myc</i>	Tumor, retrovirus	DNA-binding protein
	<i>erbA</i>	Retrovirus	Thyroid receptor

Source: Adapted from J. D. Watson, M. Gilman, J. Witkowski, and M. Zoller, *Recombinant DNA*, 2nd ed. (New York: Scientific American Books, 1992), p. 339. © 1992 James D. Watson.

Figure 23.19: Pathways by which proto-oncogenes can become oncogenes.

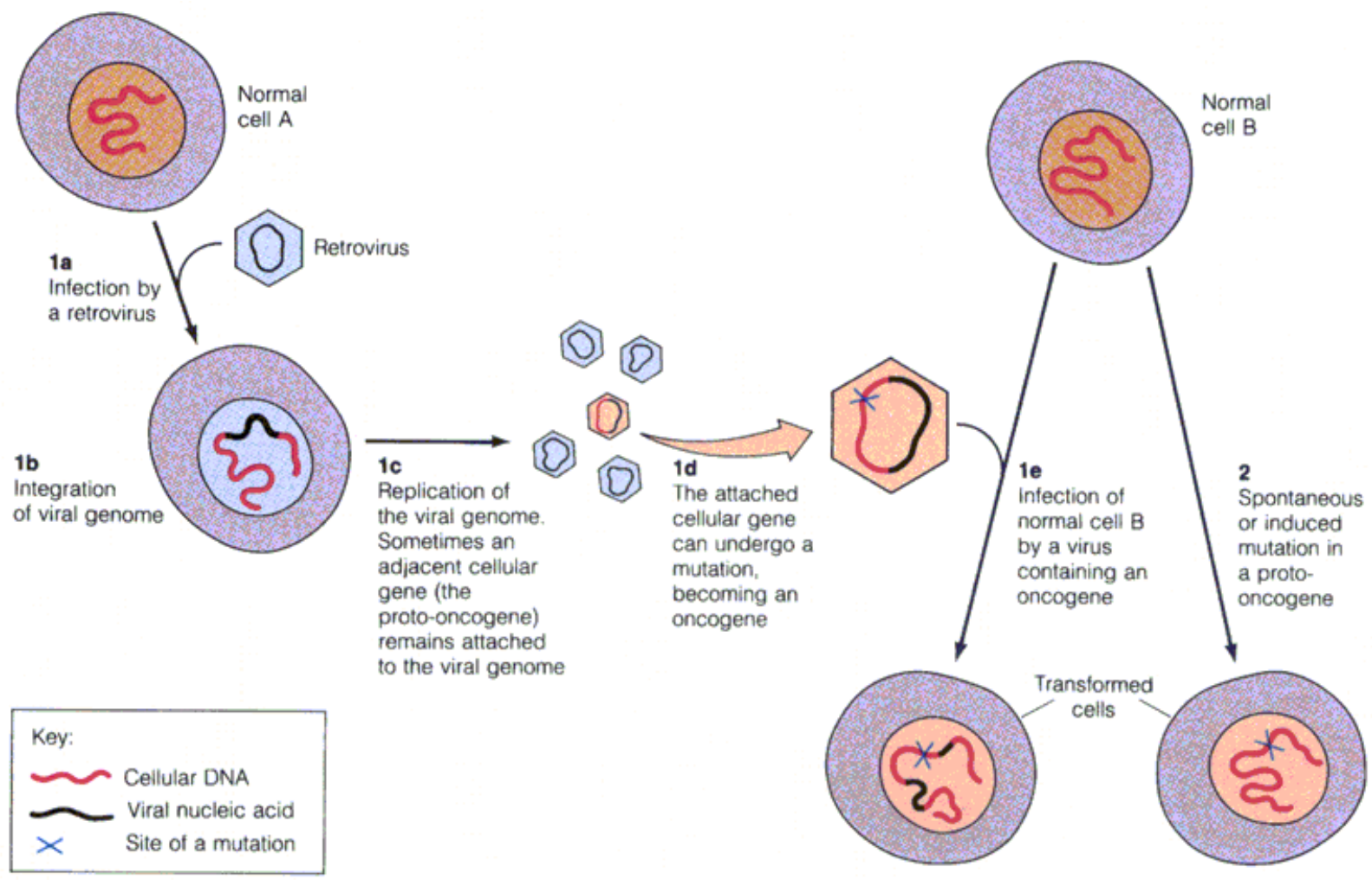

Oncogenes and Cell Signalling

The **Ras** protein occupies a central role in directing extracellular signals to the nucleus, where specific genes are activated for cell growth, division, and differentiation. Ras-related proteins have been discovered in such diverse organisms as yeast, nematode worms, and *Drosophila*, in which they control aspects of mitotic and meiotic growth and embryonic development. Research on these organisms has illuminated a central control pathway in mammalian cells (**Figure 23.23**), in the process richly justifying the use of simple biological model systems for cancer research.

Many growth factor receptors with **tyrosine kinase** activity phosphorylate themselves (steps 1 and 2 in **Figure 23.23**). In the phosphorylated state, each receptor interacts with one or more protein exchange factors, which in turn activate Ras by stimulating the **GDP-GTP** exchange (step 3). Also interacting with Ras, and limiting its activity, are proteins called GAPs (GTPase-activating proteins). Ras activates a cascade of further protein phosphorylations (step 4), which ultimately activates transcription factors (step 5). These factors interact with the genome and stimulate the expression of particular genes (see **here** and **here**).

As noted in **Figure 23.23**, one class of downstream kinases is called MAP kinase (MAPK). The acronym MAP stands for mitogen-activated protein. (A mitogen is a factor that stimulates mitosis.) Upstream of MAP kinases are another family of proteins, MAPKK (MAP kinase kinase), and still further upstream are the MAPKKK proteins (MAP kinase kinase kinase). One member of MAPKKK class of proteins is the product of the *raf* **proto-oncogene** (see **Table 23.7**). Mammalian cells contain seven known MAPKKKs, seven MAPKKs, and six MAPKs.

Thus, growth factor response is a cascade of protein phosphorylations, analogous to the cascade that controls glycogen breakdown. Blocking the Ras GTPase activity can lead to uncontrolled cell growth and cancer, by keeping the **signalling** pathway turned on and flooding the cell with growth-stimulatory signals. It is not yet clear how this pathway can explain the distinct responses of cells to different growth factors.

See also: [Viral and Cellular Oncogenes](#), [Oncogenes in Human Tumors](#), [G Proteins and Signal Transduction](#), [G Protein Families and Subunits](#), [Receptors with Protein Kinase Activity](#), [Hormone Action](#)

Figure 23.7: Eukaryotic signal transduction systems involving membrane receptors (1-5) and/or second messengers (1-4).

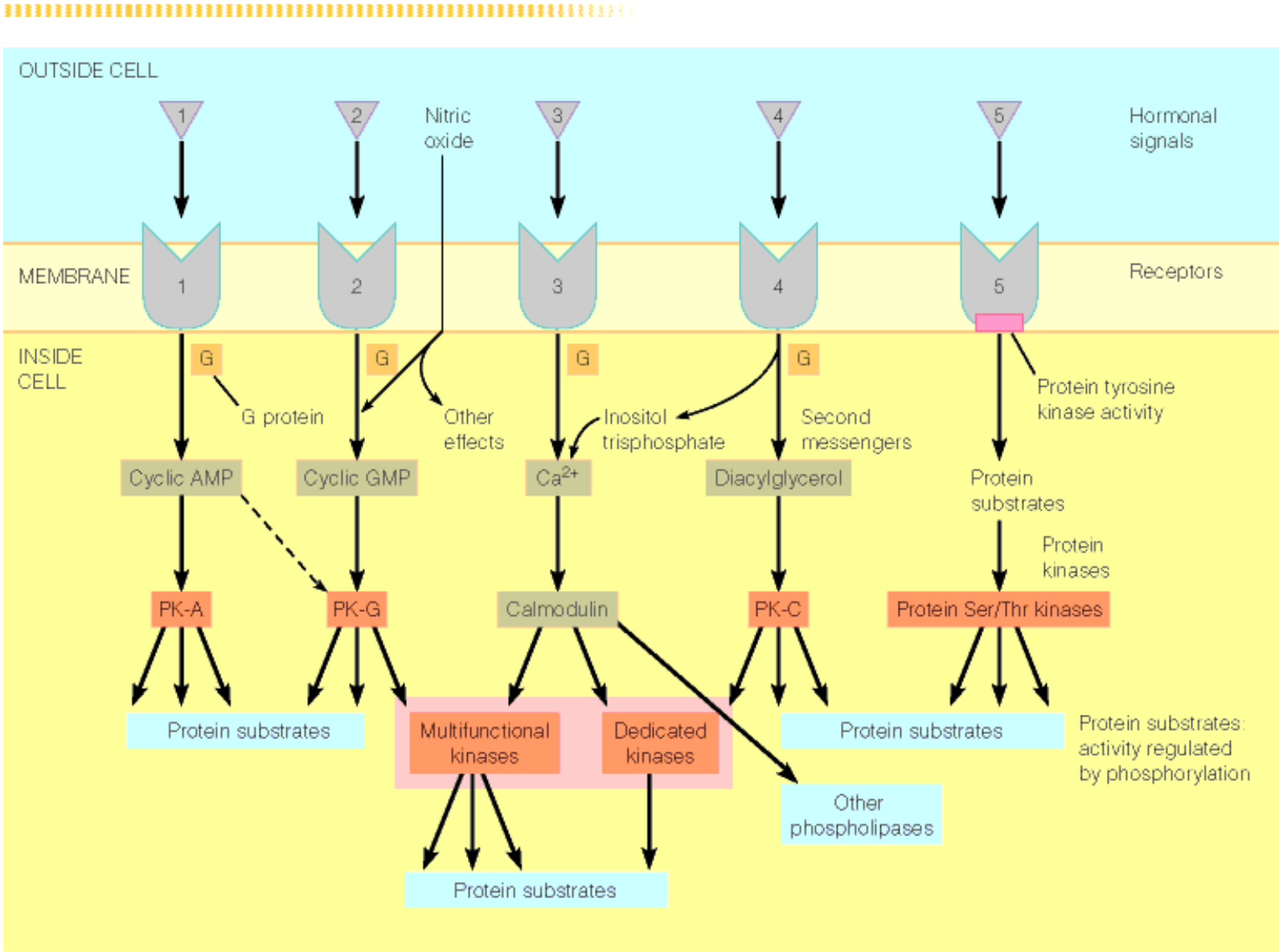

Hormone Action



Hormones are compounds secreted by specific tissues, called endocrine glands, directly into the bloodstream, rather than being excreted through ducts or stored in bladders. The response to a hormonal signal comes as a direct and rapid result of its secretion. [Figure 23.6](#) shows the locations of the major endocrine organs in the human body.

Hormones usually stimulate metabolic activities in tissues remote from the secretory organ. They are active at exceedingly low concentrations, too. Furthermore, most **hormones** are metabolized rapidly, so their effects are often short-lived, allowing rapid adaptations to metabolic changes.

A special class of **hormones** includes the eicosanoids-prostaglandins, thromboxanes, and leukotrienes (see [here](#)). These mediators act like **hormones** but are distinctive in their extreme metabolic lability, their synthesis in many cell types instead of just one endocrine gland, and their actions primarily on cells close to those that secreted them.

Hormones differ from other intercellular mediators, such as the following:

1. **Pheromones**, which are transmitted between cells of different individuals;
2. **Neurotransmitters**, which act immediately across a synaptic junction from their sites of release (see [here](#)); and
3. **Growth factors**, whose growth-stimulating activities are continuous, rather than being short-lived in response to a burst of secretion.

Distinctions among these classes of regulators are somewhat indefinite. [Catecholamines](#), such as [epinephrine](#) and [norepinephrine](#), function both as neurotransmitters and as **hormones**, depending upon their sites of synthesis and release.

The effect of epinephrine in stimulating glycogen mobilization illustrates a typical mechanism of **hormone** action. [Figures 12.13](#) and [13.18](#) show that epinephrine binds to a macromolecular receptor at the cell surface and stimulates the formation of [cyclic AMP](#), which acts as a second messenger inside the cell and in turn stimulates the phosphorylation of target enzymes. The **hormone** itself is the first messenger. All **hormones** so far investigated act through binding to specific receptors, whether the receptors are located inside the target cell or on the cell surface. The presence of specific receptors on the specific cell types determines how **hormones**, secreted into the bloodstream, affect only certain tissues. Second messengers are often used to transmit the message to the target metabolic pathway, though not all **hormone** actions involve a second messenger.

Chemically, the hormones in vertebrate metabolism include the following:

1. Peptides or polypeptides, such as [insulin](#) or [glucagon](#);
2. [Steroids](#), including [glucocorticoids](#) and the sex hormones ([androgens](#) and [estrogens](#)); and
3. Amino acid derivatives, including the [catecholamines](#) and [thyroxine](#).

See also: [Action of Insulin](#), [Action of Glucagon](#), [Action of Epinephrine](#), [Hormone Mechanisms of Action](#), [Hormone Receptors](#), [Hormone Hierarchy of Action](#)

Figure 23.6: The major human endocrine glands and their central nervous system control centers.

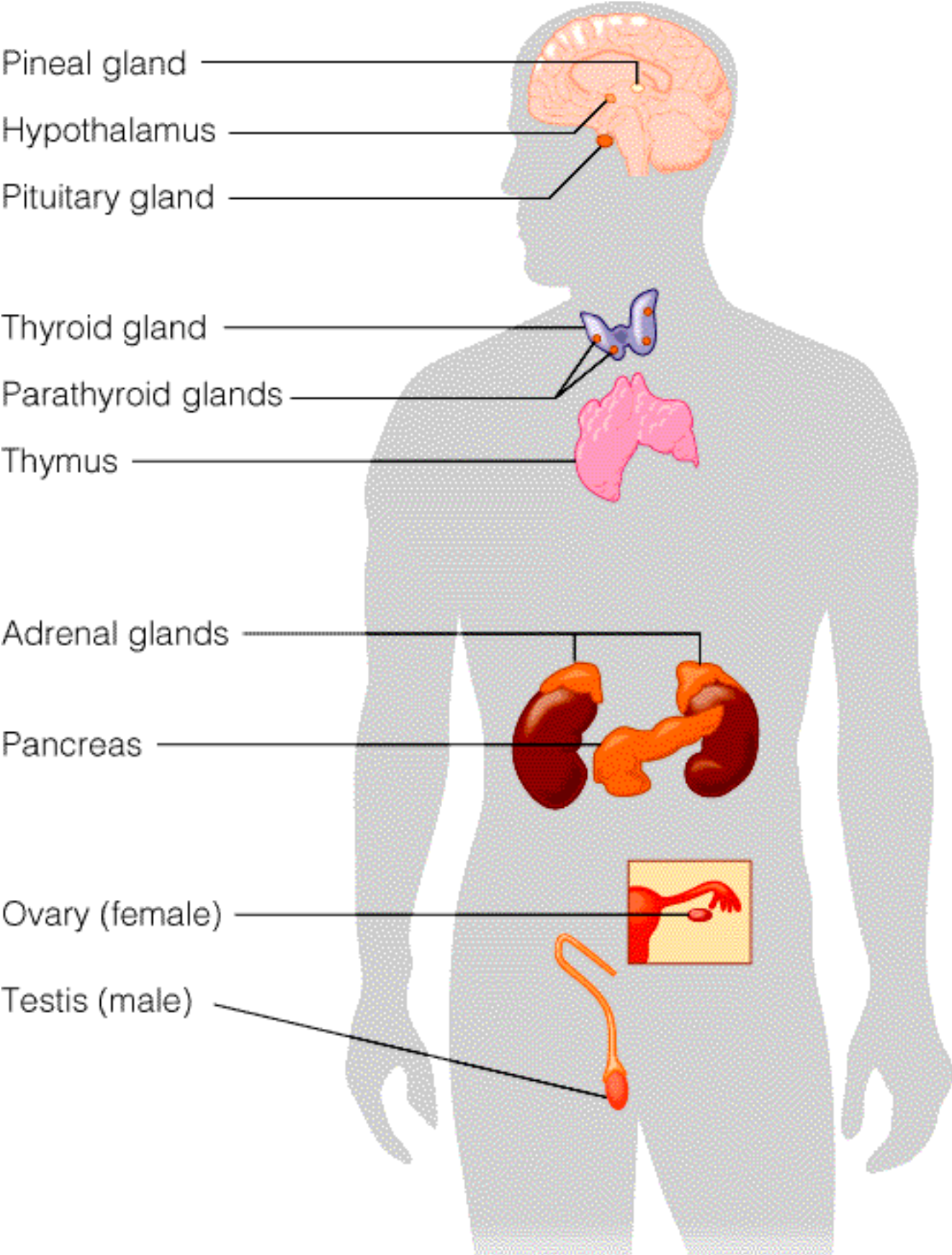

Eicosanoids

Eicosanoids are a class of lipids that include the [prostaglandins](#), [thromboxanes](#), and [leukotrienes](#).

Eicosanoids derive their name from their common origin, that is, from C20 polyunsaturated fatty acids, the eicosaenoic acids, particularly [arachidonic acid](#) (all-*cis*-5,8,11,14-eicosatetraenoic acid). Related trienoic and pentaenoic acids are minor precursors to some of these compounds.

Prostaglandins and thromboxanes are derived from a common pathway (See [Figure 19.30](#)), whereas leukotrienes are derived from arachidonic acid via a different pathway.

Structures of the major prostaglandins and thromboxane A₂ are shown in [Figure 19.29](#). In the names of prostaglandins, such as PGF₂ α , PGE₂, or PGF₂ β , the subscripted number refers to the number of double bonds in the molecule and the α/β designation indicates whether the hydroxyl group at position 9 is *cis* to the 11-hydroxyl (α) or *trans* to the 11-hydroxyl (β).

Eicosanoids exert specific physiological effects on target cells, like hormones. However, **eicosanoids** are distinct from most hormones in that they act locally, near their sites of synthesis, and they are catabolized extremely rapidly. Thus, **eicosanoids** are considered to be locally acting hormones.

See also: [Prostaglandin Biosynthesis](#), [NSAIDs](#), [Eicosanoid Functions](#)

INTERNET LINKS:

1. [Eicosanoids](#)
 2. [Prostaglandin and Leukotriene Metabolism](#)
-

Prostaglandins

Prostaglandins and **thromboxanes** are eicosanoids that are derived from a common pathway ([Figure 19.30](#)), whereas the related leukotrienes are derived from arachidonic acid via a different pathway.

Structures of the major prostaglandins and thromboxane A₂ are shown in [Figure 19.29](#). In the names of **prostaglandins**, such as PGF₂ α , PGE₂, or PGF₂ β , the subscripted number refers to the number of double bonds in the molecule and the α/β designation indicates whether the hydroxyl group at position 9 is *cis* to the 11-hydroxyl (α) or *trans* to the 11-hydroxyl (β).

Eicosanoids (like **prostaglandin**) exert specific physiological effects on target cells, like hormones. However, eicosanoids are distinct from most hormones in that they act locally, near their sites of synthesis, and they are catabolized extremely rapidly. Thus, eicosanoids are considered to be locally acting hormones.

Common **prostaglandins** include [PGA](#), [PGE](#), [PGF](#), [PGF₂](#), [PGH](#), [PGH₂](#), [PGE₂](#), and [PGI₂](#).

See also: [Prostaglandin Biosynthesis](#), [NSAIDs](#), [Eicosanoid Functions](#)

INTERNET LINKS:

1. [Eicosanoids](#)
 2. [Prostaglandin and Leukotriene Metabolism](#)
 3. [COX-2 Inhibitors](#)
-

Thromboxanes

Thromboxanes and **prostaglandins** are eicosanoids that are derived from a common pathway ([Figure 19.30](#)), whereas the related leukotrienes are derived from arachidonic acid via a different pathway.

Structures of the major prostaglandins and **thromboxane A₂** are shown in [Figure 19.29](#). **Thromboxane A₂** and, to a lesser extent, prostaglandins, induce platelet aggregation, an early step in blood clot formation.

Eicosanoids (like **prostaglandin**) exert specific physiological effects on target cells, like hormones. However, eicosanoids are distinct from most hormones in that they act locally, near their sites of synthesis, and they are catabolized extremely rapidly. Thus, eicosanoids are considered to be locally acting hormones.

See also: [Prostaglandin Biosynthesis](#), [NSAIDs](#), [Eicosanoid Functions](#), [Thromboxane B₂](#)

INTERNET LINKS:

1. [Eicosanoids](#)
 2. [Prostaglandin and Leukotriene Metabolism](#)
 3. [COX-2 Inhibitors](#)
-

Figure 19.30: Summary of biosynthetic routes to the major prostaglandins and thromboxane A₂.

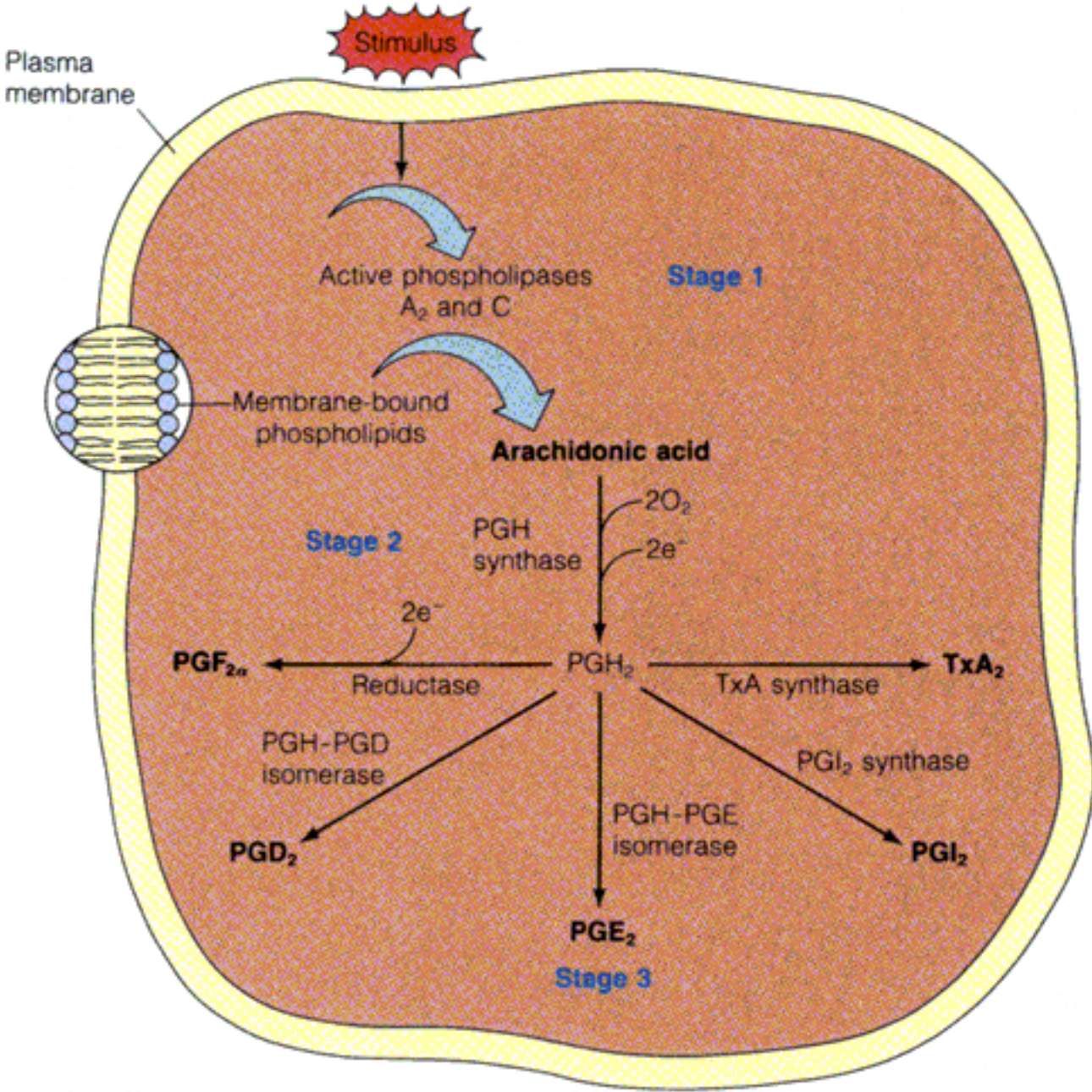
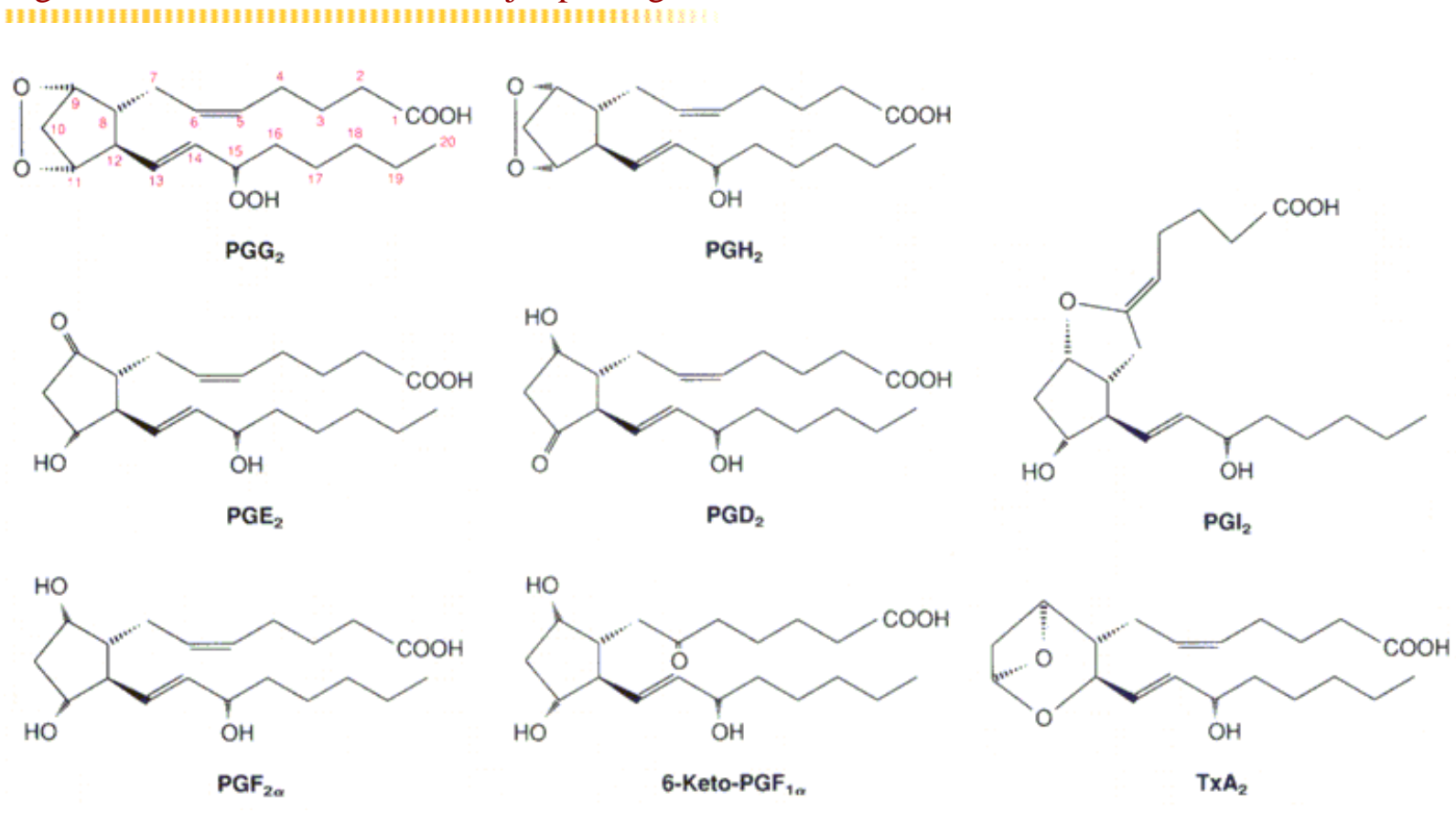

Figure 19.29: Structures of the major prostaglandins and thromboxane



Thromboxane A2

Thromboxane A2 induces platelet aggregation, an early step in blood clot formation.

See also: [Eicosanoid Functions](#),
[Eicosanoids](#), [Prostaglandin Biosynthesis](#), [NSAIDs](#),
[Thromboxane B2](#)

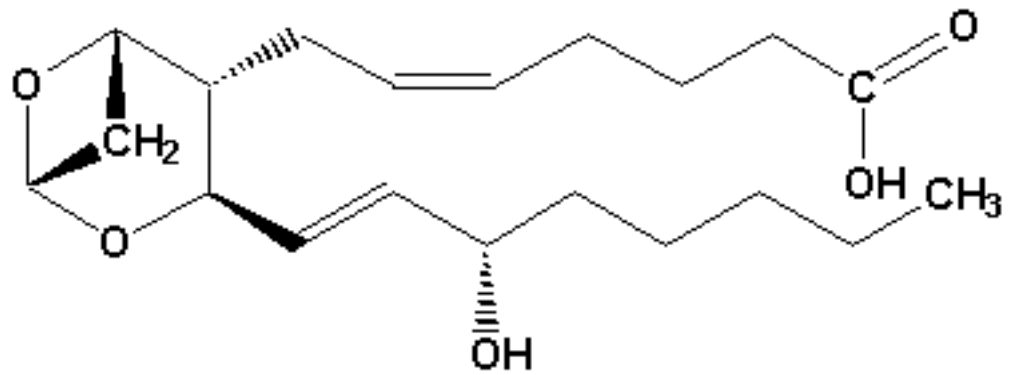

Thromboxane A2 (TxA2)

INTERNET LINKS:

1. [Eicosanoids](#)
 2. [Prostaglandin and Leukotriene Metabolism](#)
-

Eicosanoid Functions

The **eicosanoids** ([prostaglandins](#), [thromboxanes](#), and [leukotrienes](#)) have numerous effects on the body.

Prostaglandins and **Thromboxanes** act like local hormones

- [PGE](#) stimulates adenylate cyclase in some cells.
- [PGF2](#) has been reported to elevate levels of cGMP in target cells.
- Inhibition of the cyclooxygenase of [PGH synthase](#) by aspirin reduces inflammation, implicating prostaglandins in inflammation.
- [Thromboxane A2](#) and, to a lesser extent, prostaglandins, induce platelet aggregation, an early step in blood clot formation.
- Prostaglandin release is involved in uterine muscle contraction-PGF2 α is used to induce labor.
- PGF2 α inhibits progesterone secretion and regression of the corpus luteum.
- PGF2 α and [PGE2](#) are used to induce abortion in the second trimester or to induce delivery in case of the death of a fetus.
- [PGI2](#) is used to reduce the risk of blood clotting during cardiopulmonary bypass operations.
- PGE1 is a vasodilator.
- Forms of [PGE](#) inhibit gastric secretion.

Leukotrienes

- Receptors for leukotriene B4 may be involved in inflammation.
- Leukotrienes may play a role in asthma attacks.

See also: [Eicosanoids](#), [Prostaglandin Biosynthesis](#), [NSAIDs](#),

INTERNET LINKS:

1. [Eicosanoids](#)
 2. [Prostaglandin and Leukotriene Metabolism](#)
-

Leukotrienes

Leukotrienes are eicosanoids that were originally isolated from leukocytes and contain three double bonds, which explains how they were named. As shown in [Figure 19.32](#), **leukotrienes** are formed by a pathway independent of that of forming the prostaglandins and thromboxanes.

The pathway to **leukotrienes** starts by attack on arachidonate of a lipoxygenase, which adds O₂ to C-5, giving 5-hydroperoxyeicosatetraenoic acid (5-HPETE). A dehydration to give the epoxide coupled with isomerization of double bonds gives **leukotriene A₄**. Hydrolysis of the epoxide ring yields **leukotriene B₄**. Transfer of the thiol group of glutathione yields **leukotriene C₄**. Subsequent modifications of the peptide chain (not shown) yield related compounds, **leukotrienes D and E**.

See also: [Eicosanoids](#), [Prostaglandins](#), [Thromboxanes](#), [Eicosanoid Functions](#)

INTERNET LINKS:

1. [Eicosanoids](#)
 2. [Prostaglandin and Leukotriene Metabolism](#)
-

Figure 19.32: Biosynthesis of leukotrienes.

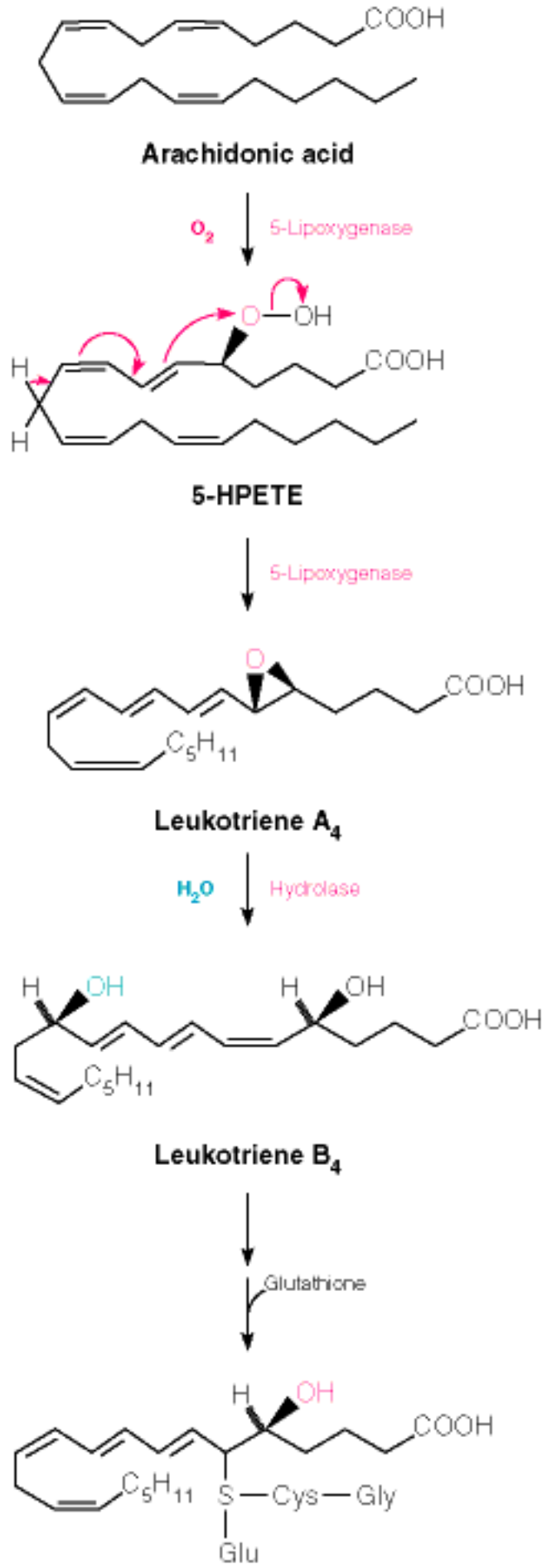

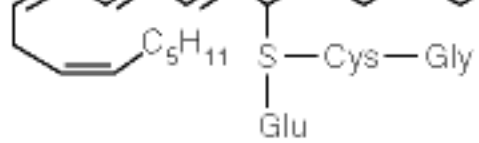

Leukotriene C₄

Prostaglandin E (PGE)

Forms of **PGE** inhibit gastric secretion.

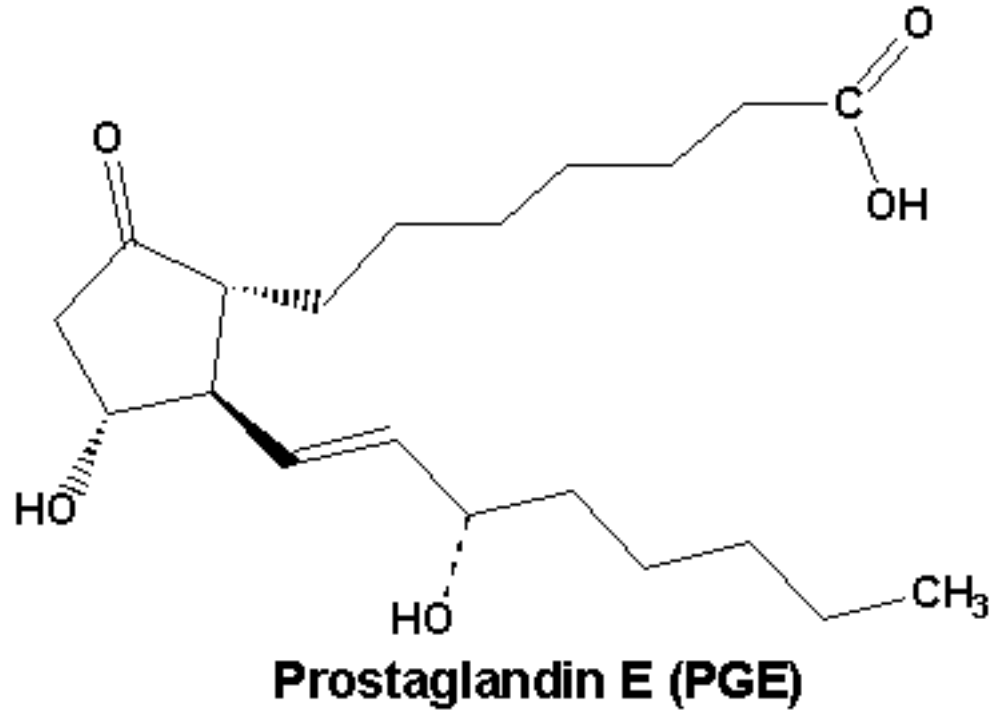

See also: [Eicosanoids](#), [Prostaglandin Biosynthesis](#), [Prostaglandins](#)

INTERNET LINK: [Prostaglandin and Leukotriene Metabolism](#)

Prostaglandin Biosynthesis

Figure 19.30 outlines the biosynthesis of the 2-series (containing 2 double bonds) of **prostaglandins**. These reactions occur in the endoplasmic reticulum.

1. **Arachidonic acid** is released from membrane-bound phospholipids. This can occur in response to stimuli by hormones (such as bradykinin or **epinephrine**) or by proteases (such as **thrombin**). The bee venom protein melittin can also stimulate arachidonate release. The following phospholipase enzymes may be involved

Phospholipase A2 may act on **phosphatidylcholine** or **phosphatidylethanolamine** to yield arachidonate.

Phospholipase C may act on **phosphatidylinositol** to yield a **diacylglycerol**, which is in turn cleaved to yield free arachidonate.

2. Arachidonate is acted on by **PGH synthase**, a bifunctional enzyme containing activities for a cyclooxygenase (introduces two molecules of O₂-see **Figure 19.31**) and another activity which involves a two-electron reduction of the peroxide formed by cyclooxygenase to give a hydroxyl group (bottom reaction in **Figure 19.31**).

3. Specific enzymes convert PGH₂ to other prostaglandins and thromboxane A₂. Some of these enzymes and the products arising from their catalysis are summarized below:

Reductase	PGF₂α
PGH-PGD Isomerase	PGD₂
PGH-PGE Isomerase	PGE₂
PGI₂ synthase	PGI₂
TxA synthase	Thromboxane A₂ (TxA₂)

See also: [Eicosanoids](#), [NSAIDs](#), [Phospholipases](#)

INTERNET LINK: [Prostaglandin and Leukotriene Metabolism](#)

Arachidonic Acid (all-*cis*-5,8,11,14-Eicosatetraenoic acid)

Arachidonic acid is a polyunsaturated fatty acid that is an important precursor of the **eicosanoids**, which include the **prostaglandins**, the **leukotrienes** and the **thromboxanes**.

Arachidonic acid is formed as **arachidonyl-CoA** from 8,11,14 eicosatrienoyl-CoA (**Figure 18.33**). The essential fatty acid **linoleic acid** is an important precursor of arachidonic acid.

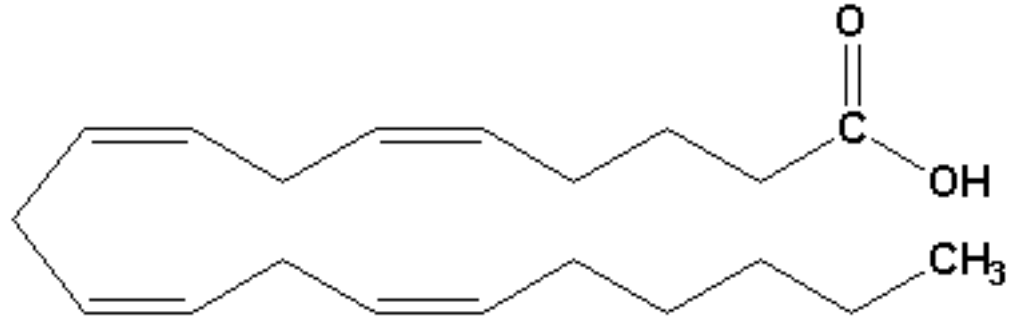

Arachidonic Acid
(all-*cis*-5,8,11,14-eicosatetraenoic acid)

See also: **Prostaglandin Biosynthesis**

INTERNET LINKS:

1. **3D Structure**
 2. **Prostaglandin and Leukotriene Metabolism**
-

Arachidonyl-CoA

Arachidonyl-CoA is formed from 8,11,14 eicosatrienoyl-CoA (**Figure 18.33**) and is a precursor of **arachidonic acid**.



See also: [Eicosanoids](#), [Prostaglandin Biosynthesis](#)

INTERNET LINKS:

1. [3D Structure](#)
 2. [Prostaglandin and Leukotriene Metabolism](#)
-

Figure 18.33: Pathway for conversion of linoleic acid to arachidonic acid in mammals.

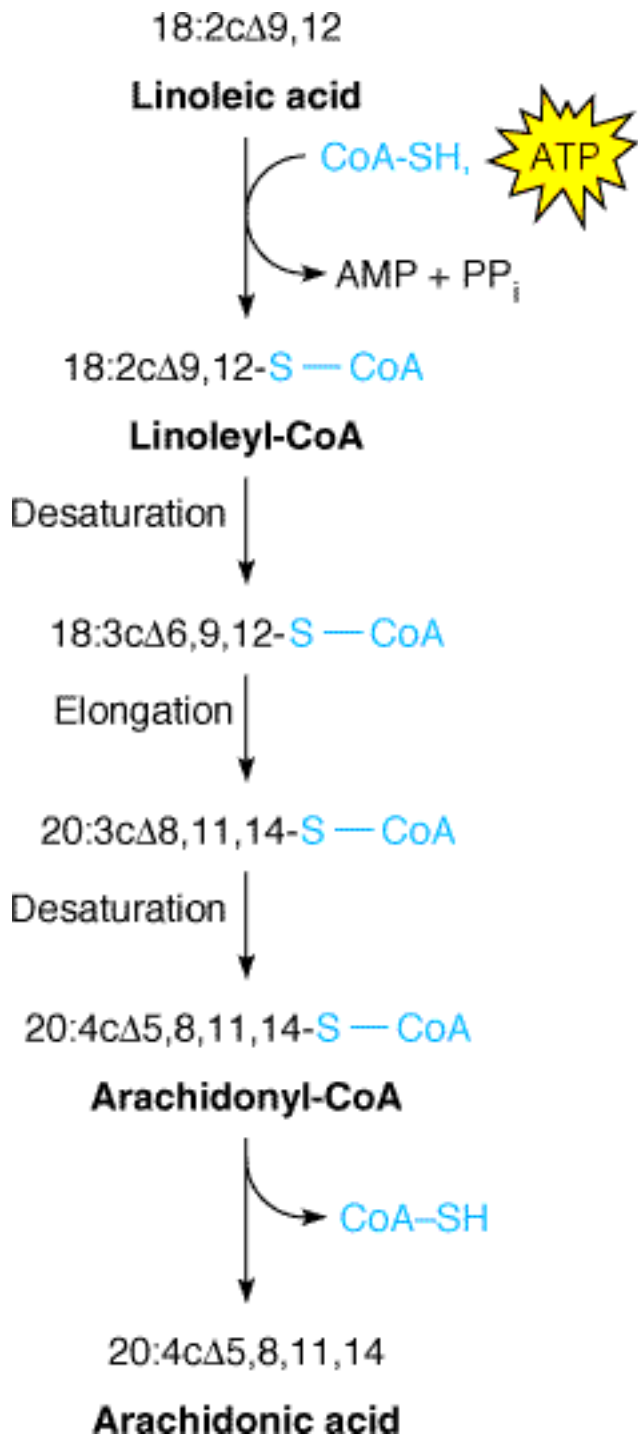

Thrombin

Thrombin is the enzyme that catalyzes the proteolytic cleavage of the inactive fibrinogen to form fibrin (the clotting material) in the blood clotting process. **Thrombin** itself is made by proteolytic cleavage of an inactive precursor, called prothrombin ([Figure 11.42](#)).

See also: [Blood Clotting](#), [Fibrin](#), [Prostaglandin Biosynthesis](#)

INTERNET LINKS:

1. [Clotting](#)
-

Figure 11.42: The cascade process in blood clotting.

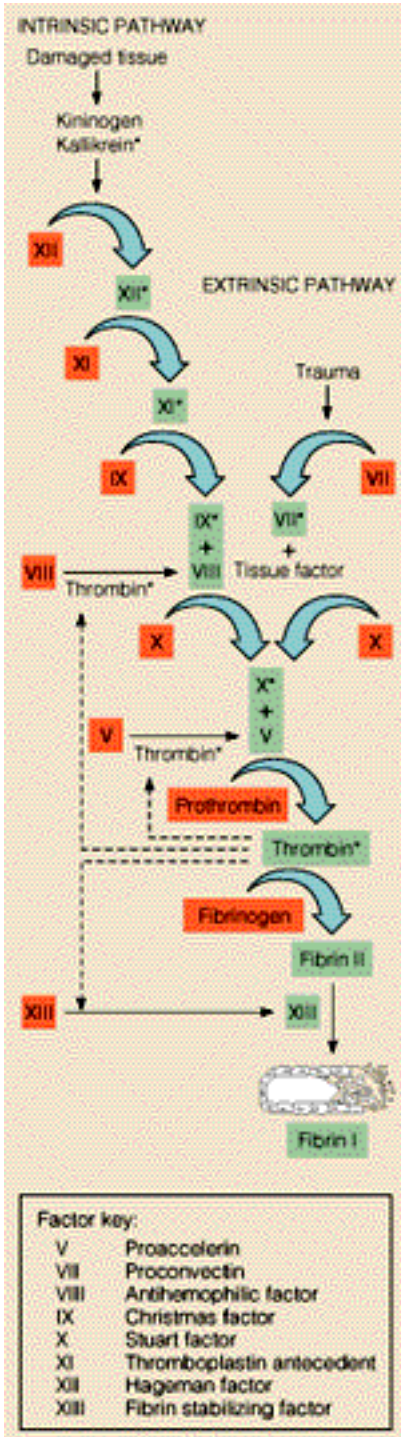

Blood Clotting



Blood clots are composed of striated fibers of a protein called fibrin. **Fibrin** fibers stick together in a staggered array. Before fibrin fibers can stick together, however, they must be derived from a **zymogen** precursor, called fibrinogen, by proteolytic cleavages that release fibrinopeptides A and B from the molecule. Removal of these small fibrinopeptides exposes sites in the fibrin molecules that allows them to stick together. Covalent cross-links between glutamine and lysine residues also form to help stabilize the structure. Thus, activation of zymogens is a key aspect to clotting of blood in vertebrates.

As can be seen in **Figure 11.42**, production of fibrin is the product of action of a cascade of proteases. These are summarized as follows:

In damaged tissue, the proteins kininogen and kallikrein activate factor XII (part of the intrinsic pathway).

Factor XII activates factor XI (part of the intrinsic pathway).

Alternatively, damage to blood vessels leads to release of tissue factor and activation of factor VII (start of the extrinsic pathway).

The extrinsic and intrinsic pathways merge with activation of factor X. Activation of factor X by factor IX of the intrinsic pathway requires factor VIII (antihemophilic factor).

Factor X activates prothrombin to thrombin.

Thrombin removes small fibrinopeptides from fibrinogen to form fibrin.

Note that the absence of factor VIII is the cause of classic hemophilia. Factor VIII is encoded on the X chromosome, so the disease is much more prominent in males, because they have only one X chromosome.

As wounds heal, **clots** must be removed. The principal agent for dissolving **clots** is an enzyme called plasmin, which is synthesized as the inactive zymogen called plasminogen. Plasminogen is activated by a number of proteases, the most important of which is tissue-type plasminogen activator (t-PA). t-PA can be extremely effective in initiating the cascade to dissolve the unwanted blood clot involved in stroke or heart attack.

See also: [Covalent Modifications to Regulate Enzyme Activity](#), [Covalent Modification of Proteins](#)

(from Chapter 27), [Thrombin](#)

INTERNET LINKS:

1. [Clotting](#)

2. [Royal Hemophilia Tree](#)

Fibrin

Fibrin is the protein fiber that forms a blood clot. **Fibrin** is produced from the precursor, fibrinogen, as the last step in a cascading series of covalent modifications of blood proteins ([Figure 11.42](#)). The enzymatic cleavage of the inactive fibrinogen to form active fibrin is catalyzed by the enzyme, thrombin.

See also: [Blood Clotting](#), [Thrombin](#)

INTERNET LINKS:

1. [Clotting](#)
-

Zymogens

A **zymogen** is a catalytically inactive protein precursor synthesized by a cell that must be activated to function. Examples include the pancreatic proteases and the blood clotting proteins. By synthesizing proteolytic enzymes (which could be harmful if active in the wrong place) as inactive precursors, the body can control when and where such enzymes are active. [Figure 11.39](#) illustrates the proteolytic cleavage of several proteases.

See also: [Covalent Modifications to Regulate Enzyme Activity](#), [Blood Clotting](#)

Figure 11.39: Zymogen activation by proteolytic cleavage.

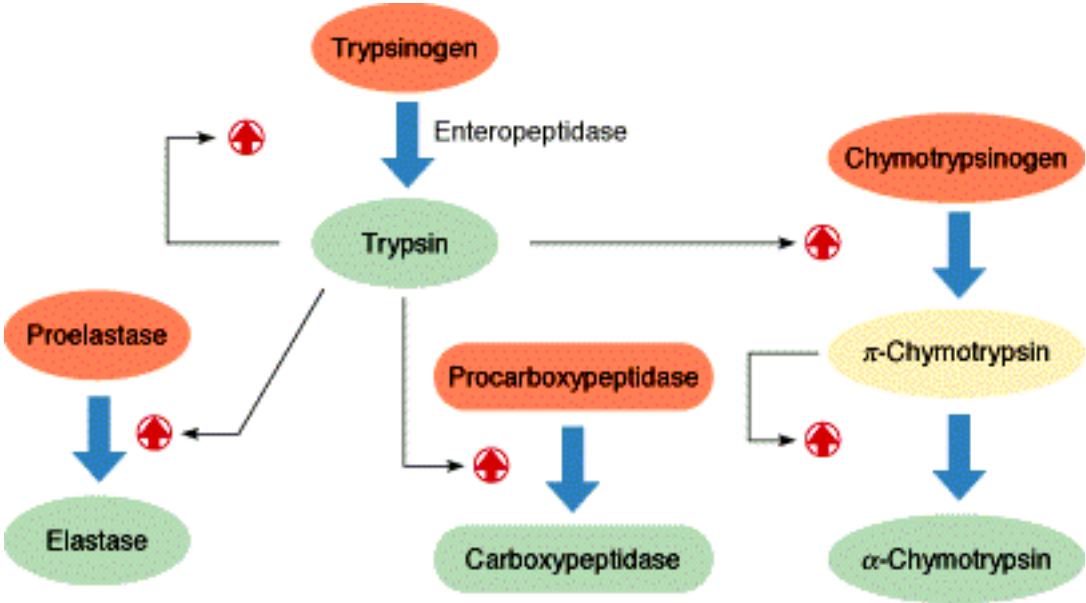

Covalent Modifications to Regulate Enzyme Activity

Covalent modification activates some enzymes and inactivates others. That is, some enzymes are wholly inactive until they are covalently modified and then begin to function. In other cases, covalent modification acts in the opposite direction, to inactivate otherwise active enzymes. Some such modifications can be reversed; others cannot.

One of the most widespread modifications is phosphorylation or dephosphorylation of various amino acid side chains (e.g., [serine](#), [threonine](#), [tyrosine](#), and [histidine](#)). These kinds of modification are most often a part of complex regulatory pathways, frequently under hormonal control. (See [kinase cascade](#)).

Another example of covalent enzyme activation is proteolytic cleavage, found in the pancreatic proteases (such as trypsin, chymotrypsin, elastase, and carboxypeptidase). These enzymes are synthesized in the pancreas in an inactive form because if they were active in the pancreas, they would digest the pancreatic tissue. Rather, they are made as slightly longer, catalytically inactive molecules called zymogens (trypsinogen, chymotrypsinogen, proelastase, and procarboxypeptidase, respectively). The zymogens must be cleaved proteolytically in the intestine to yield the active enzymes ([Figure 11.39](#)). If a small amount of protease becomes active in the pancreas, it can have painful or fatal consequences (i.e., acute pancreatitis). The pancreas protects itself from active protease action by synthesis of a protein called the secretory pancreatic trypsin inhibitor. The binding between trypsin and its inhibitor is one of the strongest noncovalent interactions known in biochemistry. The intestinal tissue is protected somewhat from damage by proteases by its glycosylated surface.

The first step is activation of trypsin in the duodenum. A hexapeptide is removed from the N-terminal end of trypsinogen by enteropeptidase, a protease secreted by duodenal cells. This yields active trypsin, which then activates the other zymogens by specific proteolytic cleavages. Trypsin will also activate other trypsinogen molecules in an autocatalytic process. Activation of a few trypsinogens ultimately leads to activation of many trypsins.

Activation of chymotrypsinogen is shown in [Figure 11.40](#). First, trypsin cleaves the bond between arginine 15 and isoleucine 16. Notice that the N-terminal peptide remains attached to the rest of the molecule due to the disulfide bond between residues 1 and 122. The enzyme is activated by the cleavage due to changes in the conformation of the molecule. These include:

Creation of a new, positively charged N-terminal residue at Ile 16;

Salt bridge formation between Ile 16 and Asp 194 (next to the active site); and

Movement of active site residues so that the amino groups of residues 193 and 195 are properly positioned to hydrogen-bond to the substrate oxyanion in the tetrahedral transition state.

Finally, autocatalytic cleavages to remove residues 14-15 and 147-148 from the molecule produce the final, active form of chymotrypsinogen, called α -chymotrypsin.

See also: [Regulation of Enzyme Activity](#), [Blood Clotting](#), [BPTI](#), [Covalent Modification of Proteins](#)
(from Chapter 27)

Figure 11.40: Activation of chymotrypsinogen.

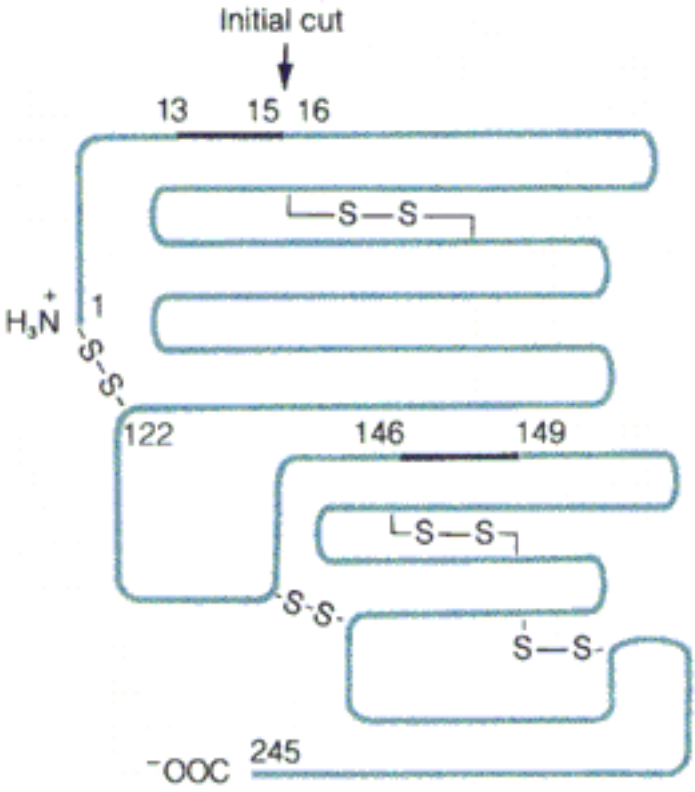

Regulation of Enzyme Activity

Enzymes function in assembly line-like fashion to catalyze the thousands of reactions occurring in cells each second. Coordinating and regulating enzymatic activities is essential for efficient functioning of cells. Several control mechanisms that do not involve covalent modification of the enzymes are possible:

Substrate level control - In this control mechanism, high levels of the product of a reaction inhibit the ability of the small amounts of substrate present to react. An example is the first step in glycolysis, catalyzed by hexokinase. It is inhibited by the product of its action, **glucose-6-phosphate**. If glycolysis is blocked for any reason, glucose-6-phosphate accumulates.

Feedback control - In this mechanism, the product of a series of reactions (like in an assembly line) inhibits the action of an earlier step in the process (usually the first step). Feedforward regulation occurs when a molecule in an assembly line reaction activates an enzyme ahead of it in the pathway.

Allosteric enzymes - These enzymes are invariably multisubunit proteins, with multiple active sites. They exhibit cooperativity in substrate binding (homoallostery) and regulation of their activity by other, effector molecules (heteroallostery).

Homoallostery - The effects of cooperative substrate binding on enzyme kinetics are shown in **Figure 11.32**. Binding of one substrate favors binding of additional substrates. Cooperative binding favors reduction of K_M for the binding of substrates after the initial one. **Figure 11.33** shows the effect of extreme homoallostery. At concentrations of S below a critical point, $[S]_c$, the enzyme is almost inactive, but then changes activity rapidly with concentrations of S greater than $[S]_c$.

Heteroallostery - This type of allosteric control involves heteroallosteric effectors which may be either inhibitors or activators of binding. If an enzyme can exist in two conformational states, T and R , that differ dramatically in the strength with which substrate is bound or which differ significantly in the catalytic rate, then the kinetics of the enzyme can be controlled by any other substance that, in binding to the protein, shifts the $T \rightleftharpoons R$ equilibrium. Allosteric inhibitors shift the equilibrium toward T and activators shift it toward the R state.

Figure 11.34 illustrates how heteroallosteric control of an enzyme affects the shape of a V -vs- $[S]$ curve. Note that shifts toward the R state (activators) increase the velocity for a given substrate concentration,

whereas shifts toward the T state have the opposite effect.

See also: [Covalent Modifications to Regulate Enzyme Activity](#), [Aspartate Carbamoyltransferase](#), [Hexokinase](#)

INTERNET LINK: [Properties of Allosteric Enzymes](#)

Figure 11.32: Effect of cooperative substrate binding on enzyme kinetics.

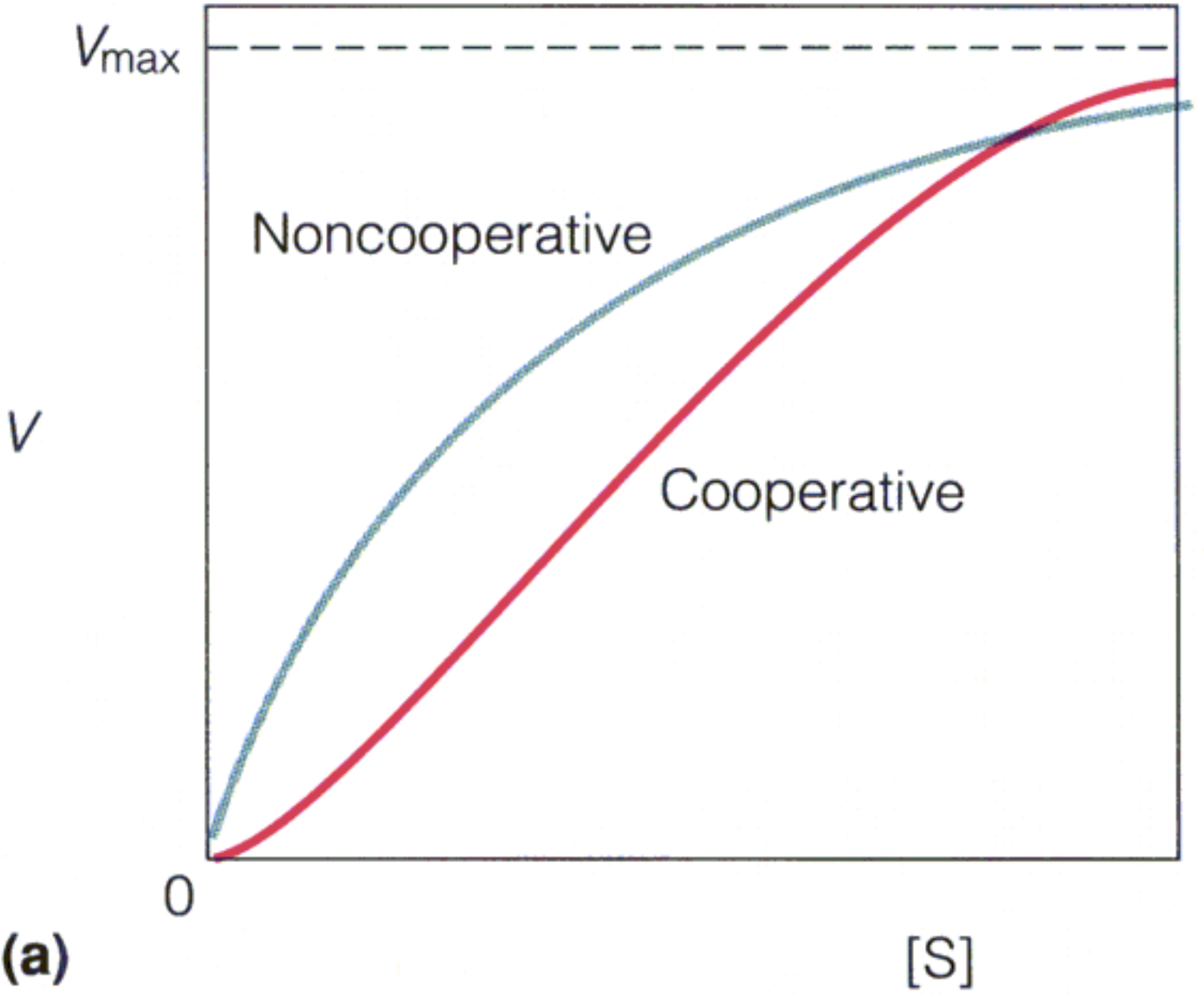

(a)

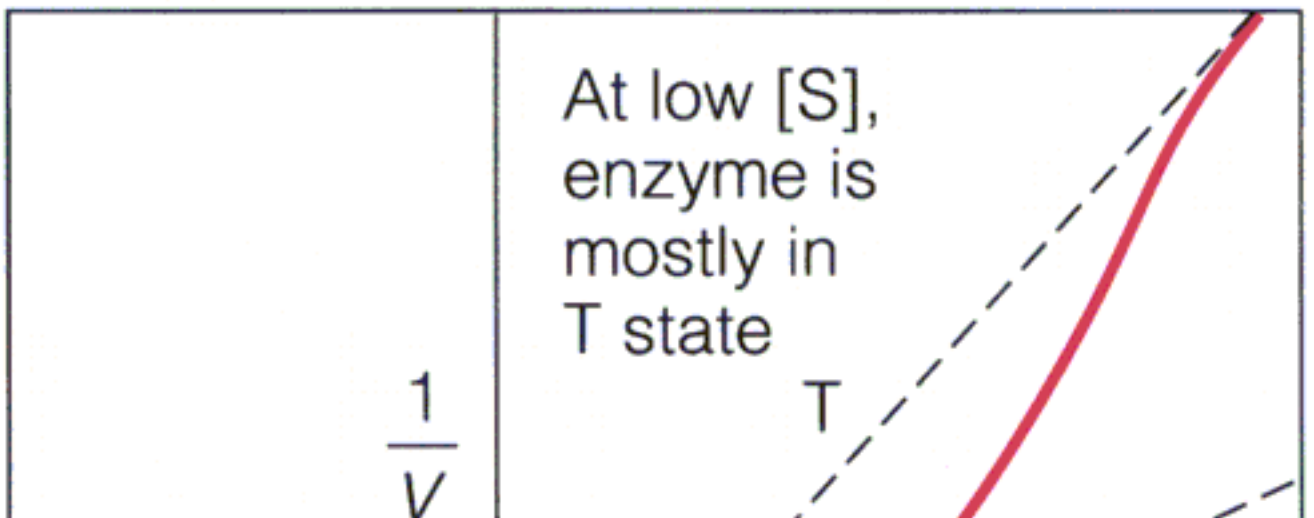

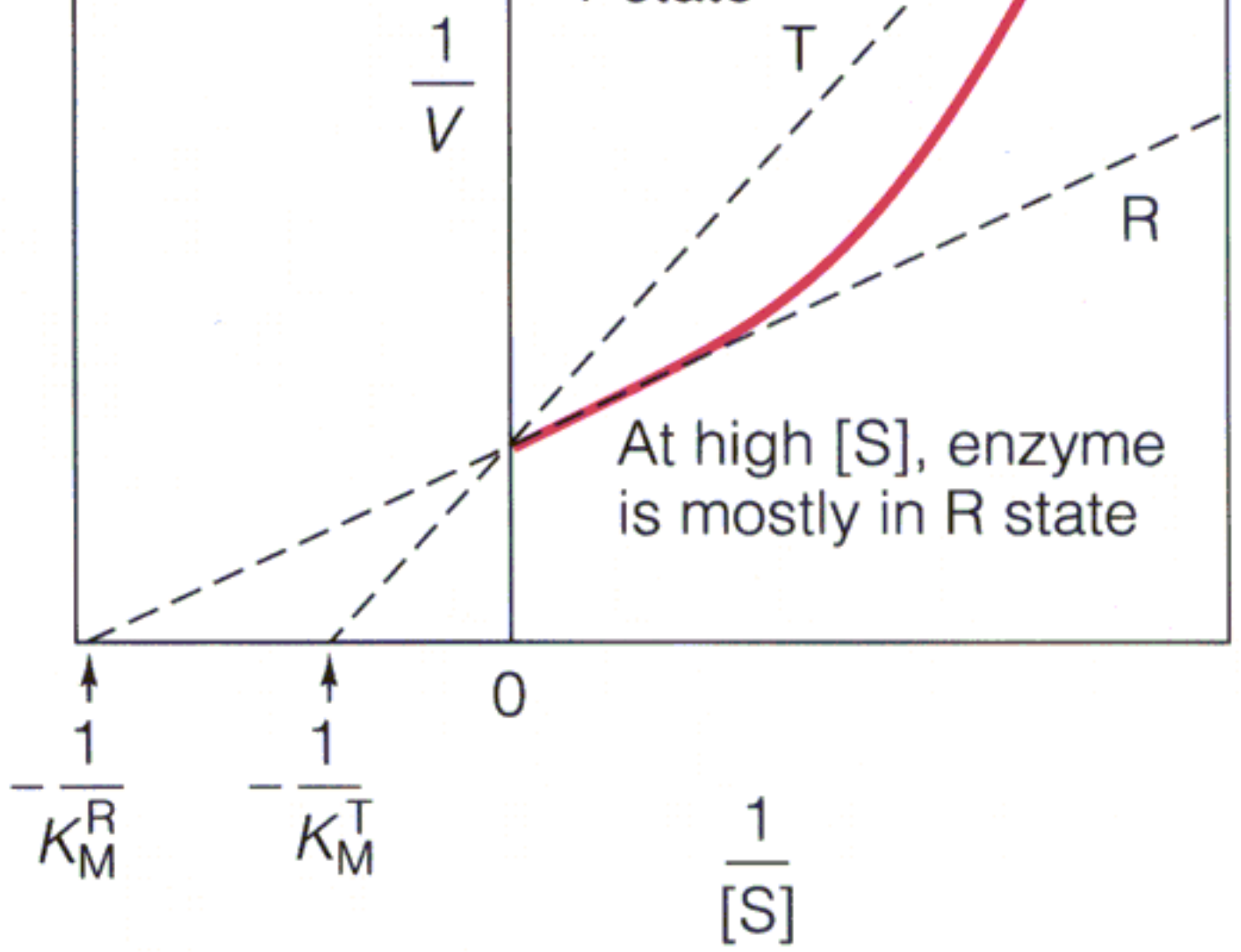

(b)

Figure 11.33: Effect of extreme homoaostery.

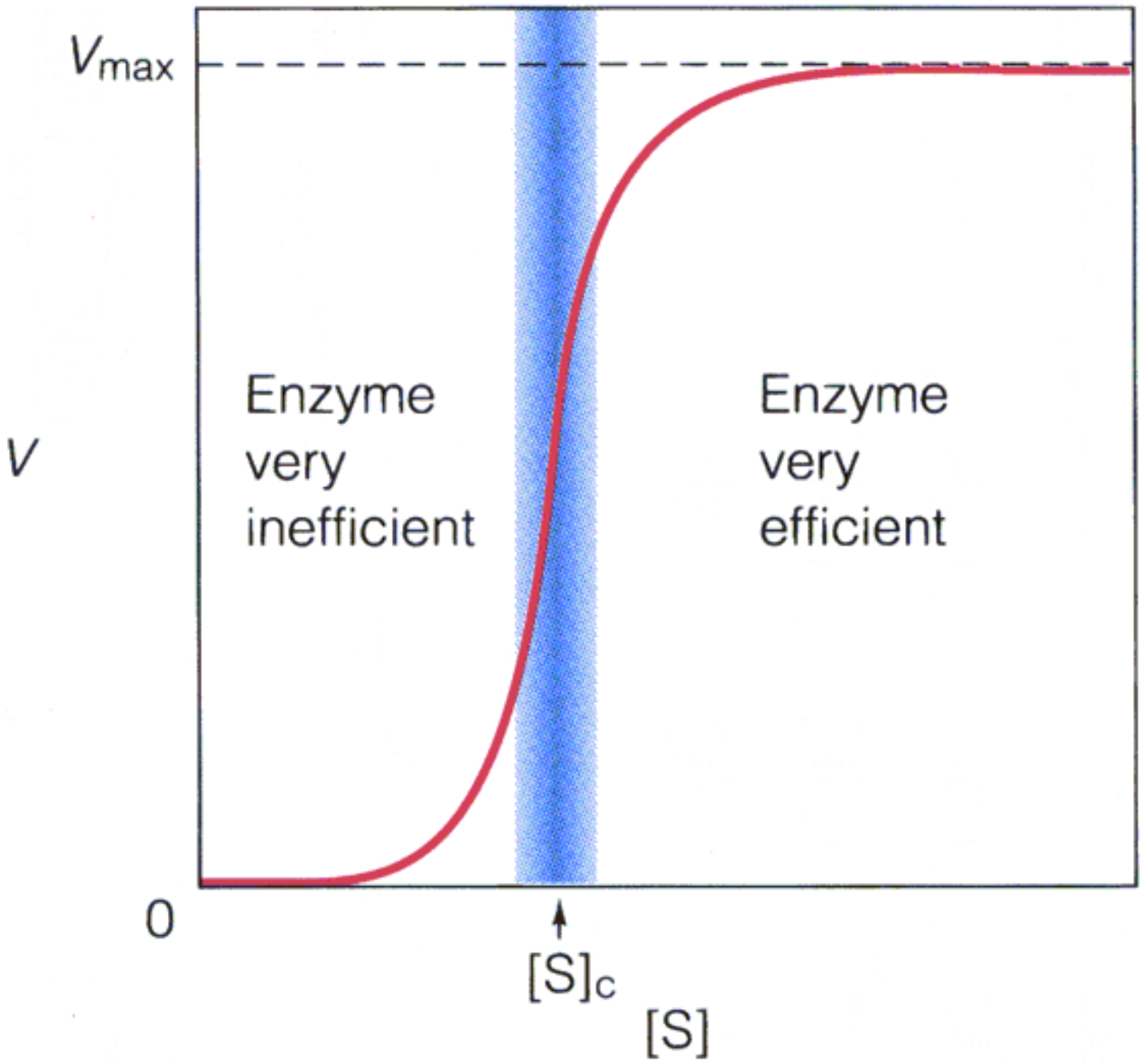
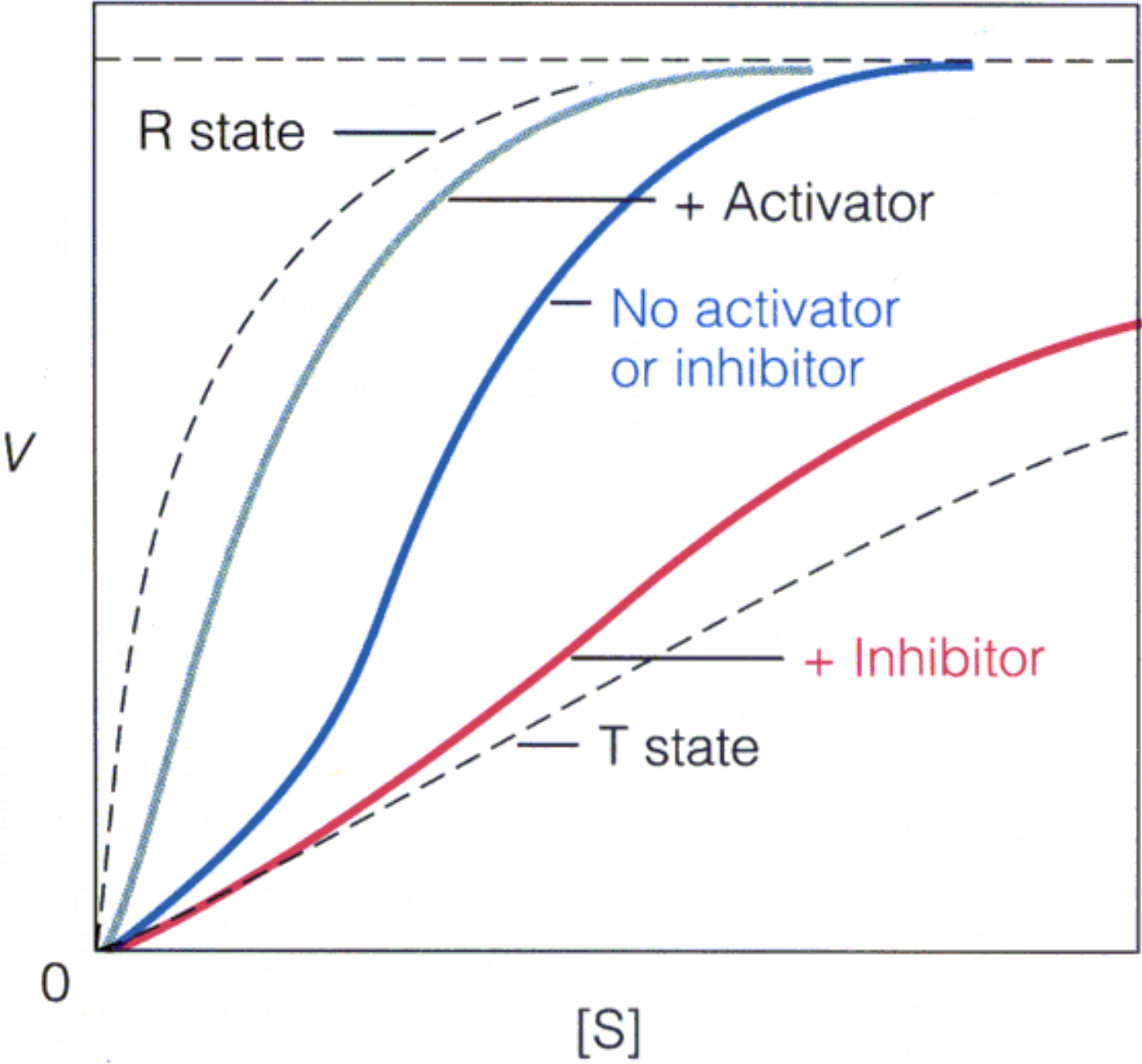

Figure 11.34: Heteroallosteric control of an enzyme.



Bovine Pancreatic Trypsin Inhibitor (BPTI)

Bovine Pancreatic Trypsin Inhibitor (BPTI) is one of the smallest and simplest globular proteins. **BPTI**'s sole function is to bind to and inhibit proteolytic enzymes like trypsin. **BPTI** contains both α helical and β sheet regions, as well as three disulfide bonds, which help to stabilize the tertiary structure of the molecule.

With three S-S bridges in 58 residues, **BPTI** is one of the stablest proteins known. It is quite inert to denaturants like urea and exhibits thermal denaturation below 100° C only in very acidic solutions; the half-point for reversible denaturation is about 80° C at pH 2.1 ([Figure 6.23](#)). But if only one of the disulfide bonds (that between cysteine residues 14 and 38) has been reduced and carboxymethylated, the midpoint is decreased to 59° C.

When all the disulfide bonds in **BPTI** are reduced, the protein is unfolded at room temperature. Yet upon reoxidation (re-forming the S-S bonds), native protein with the three correct disulfide pairings is efficiently formed. This re-formation is not what would be expected by chance. Suppose a **BPTI** molecule has been reduced, yielding 6 cysteine residues, and we now randomly reoxidize the SH groups. The first SH group to pick a partner will have 5 choices, the second group 3, and the last only 1, so there are 5 x 3, or 15, equally probable combinations. Thus, we would expect only about 7% of reduced **BPTI** to refold successfully by chance. But many studies of this and other proteins containing disulfide bonds indicate that correct pairing is regained if sufficient time is allowed. This finding must mean that it is the preferred folding of the protein that places the SH groups in position for correct pairing. The corollary of this statement is that the S-S bridges are not themselves essential for correct refolding. They do, however, contribute to the stability of the structure once it is folded. A molecule containing S-S bridges has a smaller number of conformations available in the unfolded form than does a comparable protein without the bridges. Consequently it shows a smaller entropy gain on unfolding and is therefore stabilized.

See also: [\$\alpha\$ -Helix](#), [\$\beta\$ -Sheet](#), [Factors Determining Secondary and Tertiary Structure](#), [Thermodynamics of Protein Folding](#), [Dynamics of Protein Folding](#), [Covalent Modifications to Regulate Enzyme Activity](#) (from Chapter 11).

Figure 6.23: Thermal denaturation of BPTI.

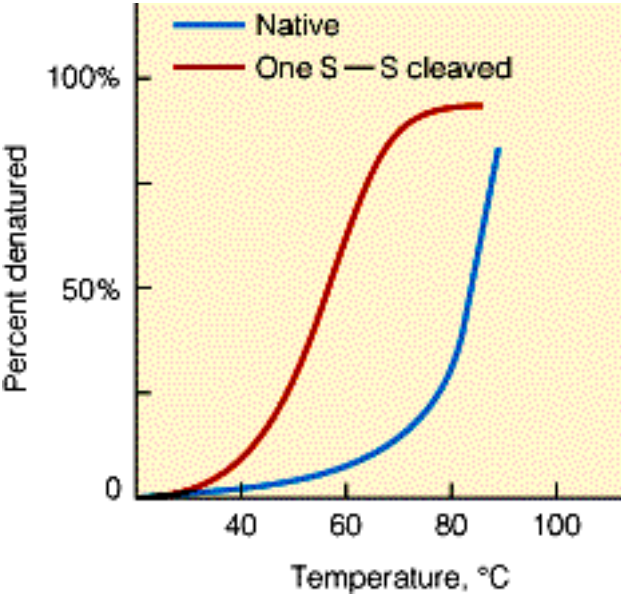

Data from J. P. Vincent, R. Chicheportiche, and M. Lazdunski, Eur. J. Biochem. (1971) 23:401-411.

α -Helix

The α -**helix** and β -sheet are common protein secondary structures that were originally predicted by Linus Pauling ([Figure 6.3](#)).

The α -**helix** structure repeats after exactly 18 residues, which amounts to 5 turns. It has, therefore, 3.6 residues per turn. Since the pitch of a helix is given by $p = nh$, we have for the α helix, with a rise of 0.15 nm/residue, $p = 3.6$ (res/turn) \times 0.15 (nm/res) = 0.54 nm/turn. Parameters for the other helices shown in [Figure 6.3](#) and [Figure 6.4](#) are listed in [Table 6.1](#).

In an α -**helix** each carbonyl oxygen is hydrogen-bonded to the amido proton on the fourth residue up the helix. Thus, if one includes the hydrogen bond, a loop of 13 atoms is formed, as shown in [Figure 6.6](#). Each of the helices shown in [Figure 6.3](#) and [Figure 6.4](#) has a different number of atoms in such a hydrogen-bonded loop. We shall call this number N. A quick way to describe a polypeptide helix, then, is by the shorthand nN, where n is the number of residues per turn. The 3₁₀ helix fits this description; it has exactly 3.0 residues per turn and a 10-member loop. The α -**helix** could also be called a 3.6₁₃ helix, and the π helix a 4.4₁₆ helix.

See also: [Secondary Structure \(General\)](#), [Secondary Structure \(Terms\)](#), [Secondary Structures \(Specific examples\)](#), [Factors Determining Secondary and Tertiary Structure](#), [\$\beta\$ Sheet](#), [Keratin](#).

Figure 6.3: The α helix and β sheet.

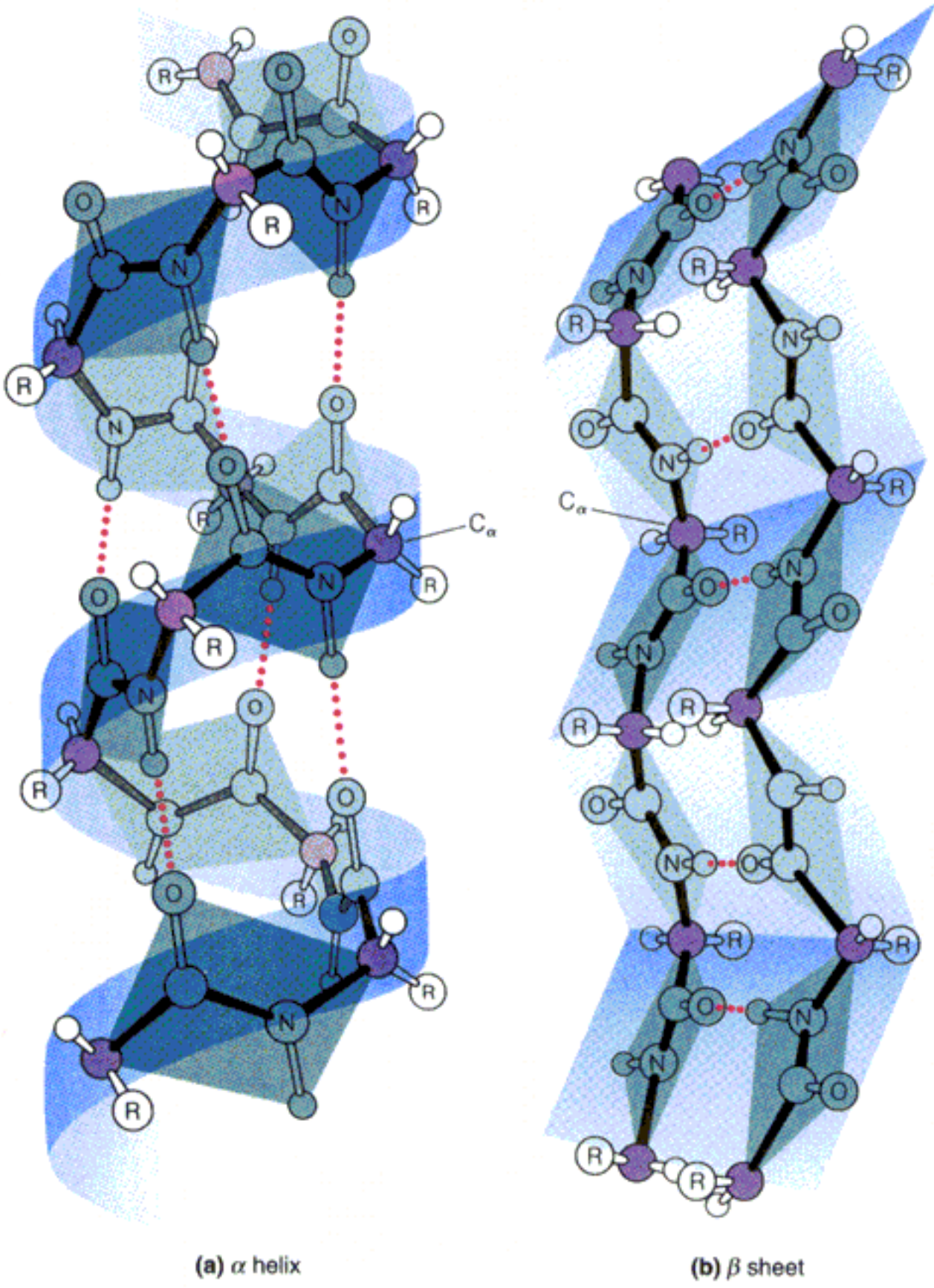

Figure 6.4: Other possible secondary structures of polypeptides.

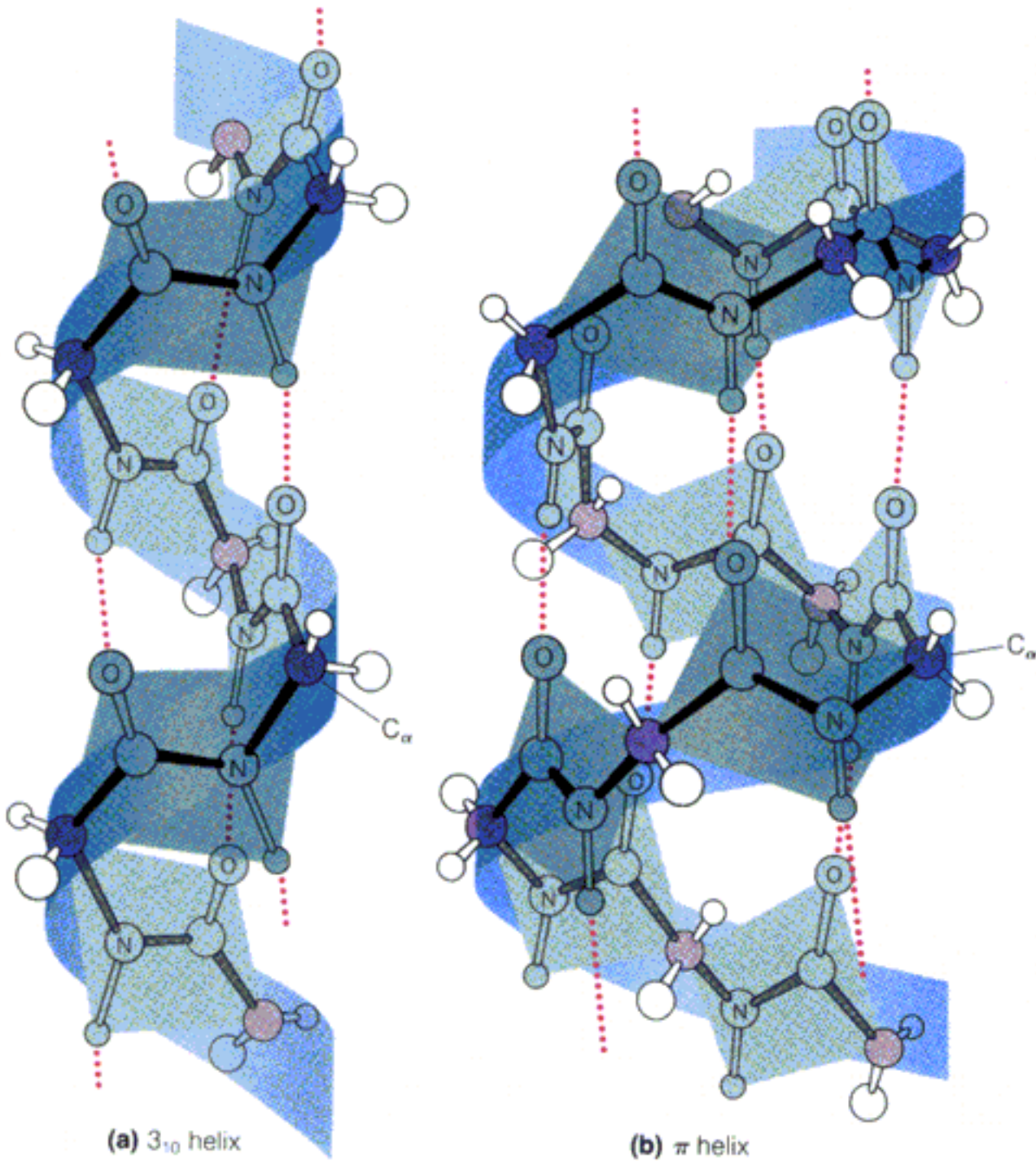

Table 6.1



Structure Type	Residues/ Turn	Rise (nm)	Number of Atoms in H-Bonded Ring	ϕ ($^{\circ}$)	ψ ($^{\circ}$)
Antiparallel β sheet	2.0	0.34	— ^a	-139	+135
Parallel β sheet	2.0	0.32	— ^a	-119	+113
3_{10} helix	3.0	0.20	10	-49	-26
α helix (3.6_{13})	3.6	0.15	13	-57	-47
π helix (4.4_{16}) ^b	4.4	0.12	16	-57	-70

^aBonding is between polypeptide chains.

^bSterically permitted but not observed in protein.

Figure 6.6: Hydrogen bonding patterns for four helices.

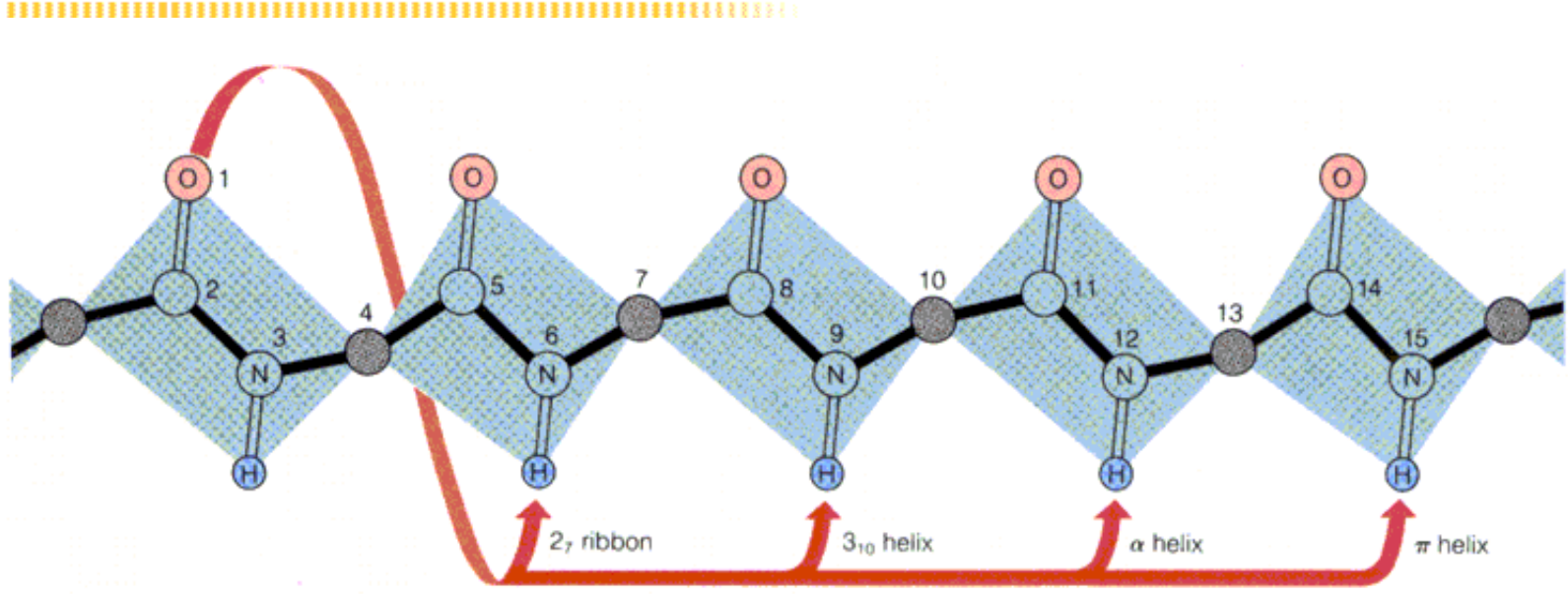

© Irving Geis.

Secondary Structure (General)

The term "**secondary structure**" refers to local folding of the backbone of a linear polymer to form a regular, repeating structure. For a polypeptide, the secondary structure is determined by the amino acid sequence (i.e., the primary structure) and the solvent environment in which it is located.

The sequence of amino acids dictates certain geometric constraints for the polypeptide. These constraints include maximum lengths between covalent bonds, limiting angles in which bonds can be bent, and van der Waals radii, which limit how tightly structures can be packed. These factors, mixed with forces that help preferentially stabilize structures, such as hydrogen bonds, ionic attractions/repulsions, hydrophobic interactions, and others, ultimately determine the shape that a peptide has over a short distance. The structure resulting from all these interactions is called the secondary structure of the protein.

Secondary structure must not be confused with the overall shape of a polypeptide. The overall shape of a polypeptide arises from the different regions of **secondary structure** folding upon each other and is called the tertiary structure if it involves only the same peptide or the quaternary structure if it involves two or more separate peptides. For example, the complete structure of myoglobin in [Figure 6.1](#) arises from primary structure (the sequence of amino acids shown as numbers), the secondary structure (the 3D scheme by which the individual amino acids are arranged with respect to each other), and the tertiary structure (the way in which the secondary structures are folded together to make the globular molecule).

Amino acids come in many shapes and sizes, and can have a range of charges at physiological pH ([Figure 5.3](#)). Despite their many differences, there is enough similarity between certain groups of these amino acids that they form the same general secondary structure, if located close together in the polypeptide chain.

An interesting aspect of **secondary structure** is that, despite the different sizes, shapes, and charges of the amino acids, regular repeating structural motifs are common in globular proteins. For example, the α -helix and the β -sheet ([Figure 6.3](#)) are common secondary structures found in many proteins and were predicted theoretically by Linus Pauling. To do this, he applied his knowledge of the structure of the amino acids and his understanding of covalent bonding (i.e., bond lengths, bond angles, and van der Waals radii).

Besides the α -helix and the β -sheet, other **secondary structures** include the 3_{10} helix (observed in some polypeptides) and the π helix ([Figure 6.4](#)), which is theoretically possible, but has never been found in a protein. [Table 6.1](#) lists five actual or theoretical secondary structures in polypeptides. Note that parallel/antiparallel indicates chain structures running in the same or opposite orientations, respectively.

There is considerably more potential for a polypeptide to assume many different structures than it

actually does. Theoretically, every single bond in a polypeptide could freely rotate ([Figure 6.2](#)), but there are stabilizing forces (as well as repulsive forces) that help to significantly limit the number of possible configurations in a polypeptide.

See also: [Secondary Structures \(Specific examples\)](#), [Prediction of Secondary and Tertiary Protein Structure](#), [\$\alpha\$ -Helix](#), [\$\beta\$ -Sheet](#)

Figure 6.2: Rotation around the bonds in a polypeptide chain.

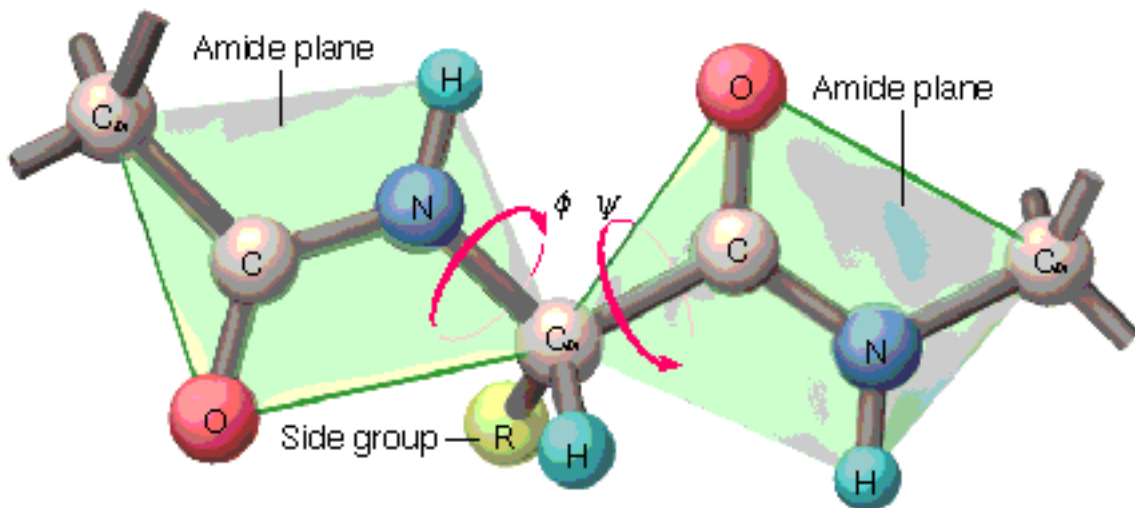

Secondary Structure (Specific Examples)

Figure 6.3 and **Figure 6.4** illustrate actual and theoretical repeating **secondary structures** of polypeptides. **Figure 6.5** illustrates how helices having an integral number (n) of amino acid residues per turn of the helix would look. The convention is to use positive values of ' n ' for right-handed helices and negative values of ' n ' for left-handed helices. Thus, the structure in **Figure 6.5** with $n = -3$ is a left-handed helix with 3 amino acids per turn of the helix. Notice that values of ' n ' close to zero yield "extended" structures (p is maximized), whereas higher values of ' n ' produce structures with a more compact design (p is minimized).

Common repeating **secondary structures** are listed in **Table 6.1**.

Non-repeating **secondary structures** for a polypeptide are also common. These include structures called "random coils" because they lack a repeating structure.

See also: [Ramachandran Plots](#), [Secondary Structure \(General\)](#), [Secondary Structure \(Terms\)](#)

INTERNET LINK: [Protein Secondary Structure](#)

Figure 6.5: Idealized helices.



$n = 5$
Ring

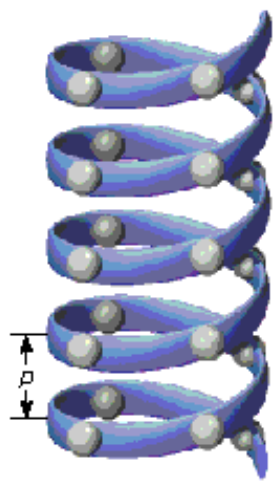

$n = 4$
Helix (right-handed)

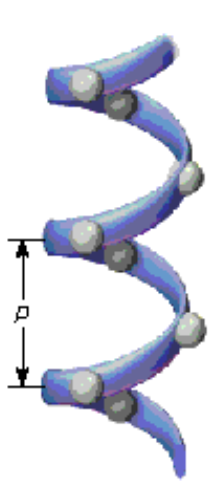

$n = 3$
Helix (right-handed)

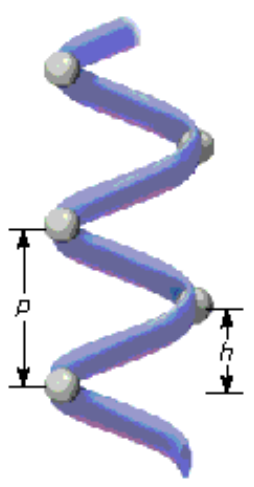

$n = 2$
Flat ribbon

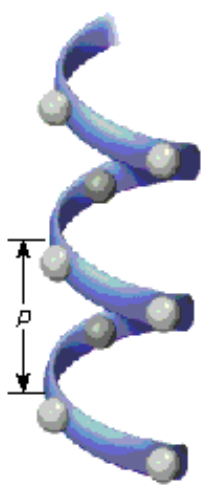

$n = -3$
Helix (left-handed)

Ramachandran Plots

Several parameters are involved in completely describing a polypeptide helix or pleated sheet. Helices can be either left-handed or right-handed. The number of amino acids per repeat of the structure can vary between two and five. Also, the planes of the peptide bond (Ψ and Φ angles in [Figure 6.2](#)) can be rotated about the α carbon. If one considers theoretically that both Ψ and Φ can rotate 180° in either direction ($+180^\circ$ to -180°), then one can begin to construct a graphical representation of all Ψ and Φ rotations about a peptide bond.

Imagine that you constructed all theoretical helices in both the left- and right-handed orientations for which $n=2, 3, 4,$ or 5 (right-handed helix) or $n = -2,-3,-4,$ or -5 (left-handed helix). These are theoretical because some of the structures would create unstable bonds at the molecular level. A computer program could make such a set of theoretical structures, however, without the concern for stability. With a program, one could then determine the Ψ and Φ angles of each of the secondary structures and plot the information on a graph of Ψ versus Φ , as in [Figure 6.8](#). The blue lines in [Figure 6.8](#) define angles for left-handed helices and the red lines define angles for right-handed helices. The black line in the center defines angles for the pleated sheets.

Keep in mind that real molecules have rules about how stable their bonds are as a function of distance between the atoms, charge, and the angles of the bonds. One can determine which angles of Ψ and Φ produce stable and unstable structures using this knowledge from chemistry (assuming, in this case, that all of the amino acids are alanine) and then superimpose stability information on the graph. The stable regions are shown in white in [Figure 6.8](#) and the unstable regions are shown in blue (left-handed helix) or red (right-handed helix). Finally, the Ψ and Φ angles for predicted secondary structures, such as the α helix and β pleated sheets, are plotted as yellow circles and marked accordingly.

This graph, called a **Ramachandran Plot**, illustrates the relatively small percentage of all theoretical Ψ and Φ rotations that are stable for peptide bonds - at least ones involving only alanine (remember the assumption above). Real proteins, such as [Bovine Pancreatic Trypsin Inhibitor](#) have structures that largely lie within the stable regions of a **Ramachandran Plot** ([Figure 6.10](#)). The Ψ and Φ angles of the protein that lie in an "unstable" region may be due to the incorrect assumptions inherent in making the plot or unknown distortions tolerated in the unique chemical environment of a protein.

The **Ramachandran Plot** also shows that both right- and left-handed polypeptide helices can be stable, though it turns out that right-handed helices are more stable than left-handed ones, due to the bulkiness of the side chains of the L-amino acids making up biological proteins.

See also: [Secondary Structure \(General\)](#), [Secondary Structure \(Terms\)](#), [Secondary Structures \(Specific examples\)](#),

Figure 6.8: A Ramachandran plot.

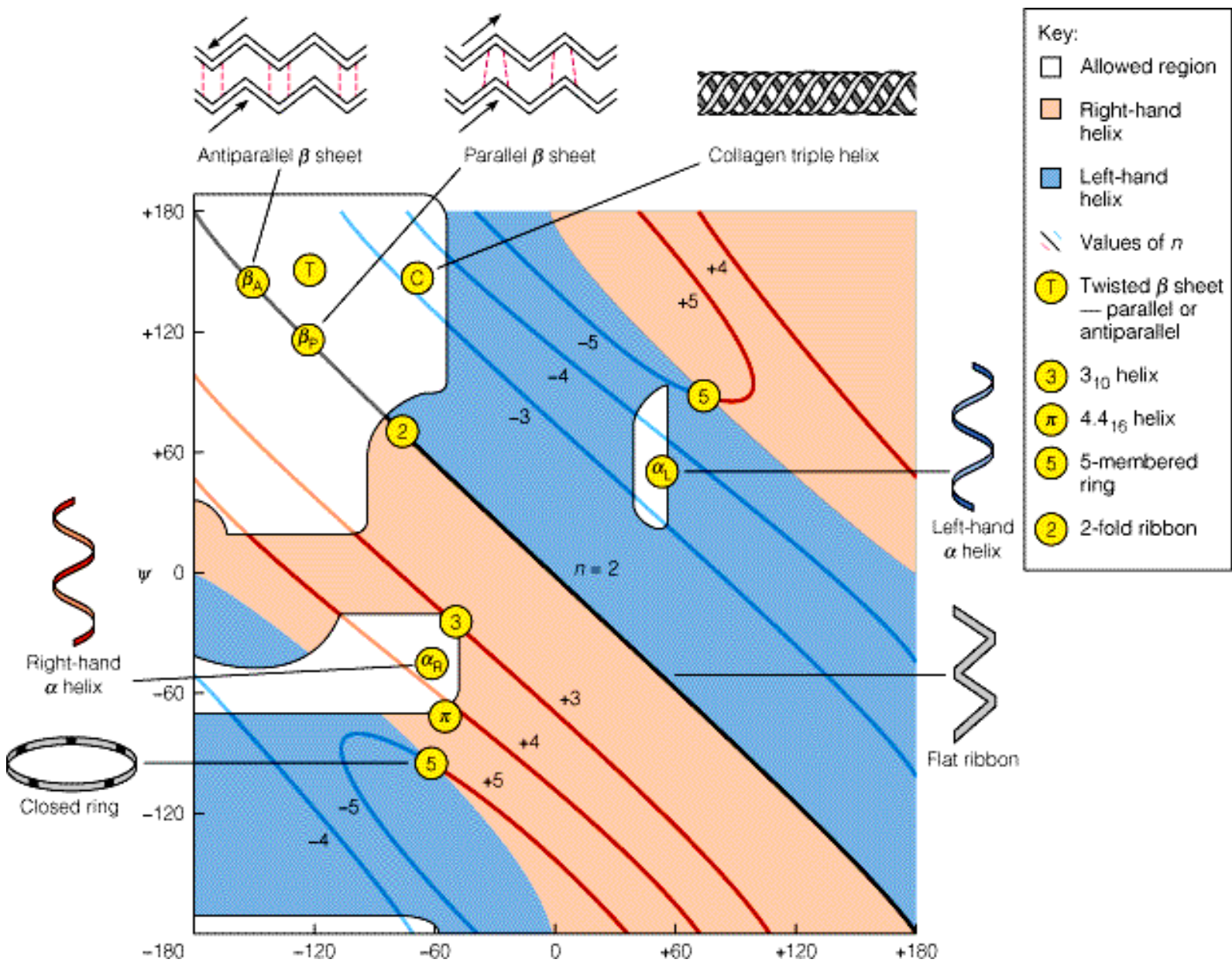
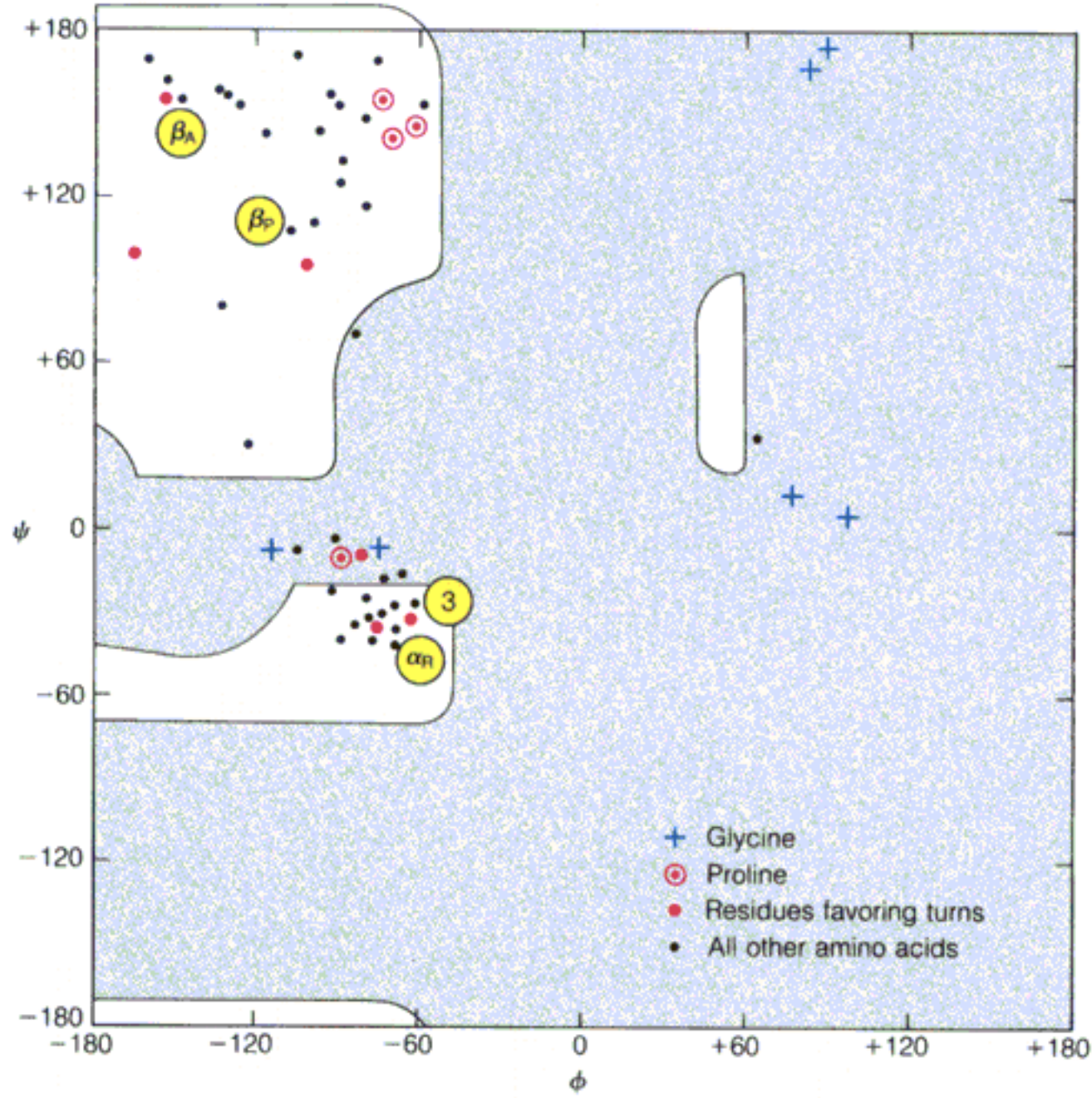

Figure 6.10: Ramachandran plot of the residues in bovine pancreatic trypsin inhibitor (BPTI).



Secondary Structure (Terms)

In describing a polypeptide secondary structure, there are several terms to understand.

Figure 6.2 illustrates the rotation that can take place about the $N-C_{\alpha}$ and $C_{\alpha}-C(O)-$ bonds in a polypeptide chain. The angles of rotation about these bonds are defined as ϕ and ψ , respectively. The closer ϕ and ψ approach 180° or -180° , the more extended (like a β sheet) the overall structure is. The closer ϕ and ψ approach zero (like an α -helix), the more compact (and coiled) the overall structure is.

Helices are repeating coiled structures commonly found in polypeptides. A helix can be described using the following important terms (**Figure 4B.2**).

Axis - a helix has an axis that is a central line of symmetry running through it.

Pitch (p) - the spacing distance between individual adjacent coils of the helix. For an α -helix, $p=0.54$ nm/turn

Repeat (c) - the distance along the axis it takes for a helix to exactly repeat itself. For an α -helix, the helix repeats itself after 5 turns, so $c=2.7$ nm. For the helix in **Figure 4B.2**, the term 'm' is defined as the integral number of polymer residues it takes for the helix to repeat. In that example, $m=4$. For an α -helix, $m = 18$ (5 turns times 3.6 residues per turn).

Rise (h) - the distance the helix "rises" between adjacent polymer units. For an α -helix, $h=0.15$ nm/residue.

Helices can be coiled in two different ways, and are referred to as right- or left-handed. In **Figure 6.5**, compare the $n=3$ helix (right-handed) with the $n = -3$ helix (left-handed).

If a helix is "flattened", the resulting structure is a **β sheet**.

Hydrogen bonds stabilize secondary structures. These can be within a chain (as in an α -helix) or between different chains (as in a β -pleated sheet). **Figure 6.6** illustrates how hydrogen bonds stabilize four different helical structures. When hydrogen bonds stabilize adjacent polypeptide chains in β -sheet structures, the adjacent chains can be oriented parallel or antiparallel to each other. When both chains are parallel, they have the same amino to carboxyl orientation. When they are **antiparallel**, the two chains have opposite amino to carboxyl orientations.

Figure 6.6 helps illustrate another important naming convention which describes helices. Recall from **Table 6.1** that a 310 helix has 3 residues per turn and a 10 member loop. The "loop" can be seen in

Figure 6.6 by the numbered atoms. Thus, for a 310 helix, atom #1 is the oxygen and atom #10 is the unnumbered hydrogen below nitrogen #9. Notice, furthermore, that an α -helix is also a 3.613 helix, because it has 3.6 residues per turn and a loop of 13.

See also: [Secondary Structure \(General\)](#), [Secondary Structures \(Specific examples\)](#), [Ramachandran Plots](#), [Hydrogen Bonds](#) (from Chapter 2), [\$\alpha\$ -Helix](#), [\$\beta\$ -Sheet](#), [Factors Determining Secondary and Tertiary Structure](#)

Figure 4B.2



β -Sheets

The α -helix and β -sheet are common protein secondary structures that were originally predicted by Linus Pauling ([Figure 6.3](#)). The β sheet structure is most elegantly utilized in the fibers spun by silkworms and spiders. Silkworm fibroin ([Figure 6.12](#)) contains long regions of antiparallel β sheet, with the polypeptide chains running parallel to the fiber axis. The β sheet regions comprise almost exclusively multiple repetitions of the sequence

[Gly - Ala - Gly - Ala - Gly - Ser - Gly - Ala - Ala - Gly - (Ser - Gly - Ala - Gly - Ala - Gly)₈]

Almost every other residue in this sequence is **Gly** and between them lie either **Ala** or **Ser** residues. This alternation allows the sheets to fit together and pack on top of one another in the manner shown in [Figure 6.12](#). The arrangement results in a fiber that is strong and relatively inextensible, because the covalently bonded chains are stretched to nearly their maximum possible length. Yet the fibers are very flexible, because bonding between the sheets involves only the weak van der Waals interactions between the side chains, which provide little resistance to bending.

Not all of the fibroin protein is in β -sheets. As the amino acid composition in [Figure 6.12](#) shows, fibroin contains small amounts of other, bulky amino acids like valine and tyrosine, which would not fit into the structure shown. These are carried in compact folded regions that periodically interrupt the β -sheet segments, and they probably account for the amount of stretchiness that silk fibers have. In fact, different species of silkworms produce fibroins with different extents of such non - β -sheet structure and corresponding differences in elasticity. The overall fibroin structure is a beautiful example of a protein molecule that has evolved to perform a particular function -- to provide a tough, yet flexible fiber for the silkworm's cocoon or the spider's web.

See also: [Secondary Structure \(General\)](#), [Secondary Structure \(Terms\)](#), [Secondary Structures \(Specific Examples\)](#), [Factors Determining Secondary and Tertiary Structure](#), [\$\alpha\$ -Helix](#), [Fibroin](#)

Factors Determining Secondary and Tertiary Structure

A major area of inquiry about protein structure has been the quest to understand how a globular protein folds into its characteristic shape. Much evidence indicates that the [amino acid sequence](#) plays a major role, because subtle changes in the sequence can easily change the secondary and tertiary structures of proteins.

Amino acid sequence - Secondary and tertiary structures can usually be destroyed (called denaturation) by heating a protein or changing the solvent environment (pH, salt content, organic content, etc.) in which the protein is dissolved. When the characteristic structure of a protein molecule in its physiological environment is lost, so too is the protein's normal function. If ribonuclease is heated to 80° C, it is converted from its normal, native state to a denatured state ([Figure 6.20](#)), which is unable to catalyze the cleavage of RNA. If the original physiological conditions are restored to ribonuclease, however, the activity and original structure of ribonuclease returns, indicating the molecule carries sufficient information in its amino acid sequence to properly fold itself. Though some proteins may need "help" in folding into the proper configuration, self-assembly of secondary and tertiary structures appears to be a general property of proteins.

Thermodynamic Factors - Folding is a thermodynamically favored process. [Figure 6.22](#) helps illustrate the relative contributions to the free energy of folding of globular proteins.

Disulfide Bonds - Bonds between cysteine residues in a protein help to stabilize it once it has folded. Bovine pancreatic trypsin inhibitor ([BPTI](#)), which has 3 disulfide bonds in its 58 amino acid sequence, is one of the stablest proteins known. When the bonds are in place, it can be denatured at 100°C only in very acid solutions. Removing one disulfide bond reduces its resistance to thermal denaturation considerably. Removing all of the disulfide bonds causes it to unfold at room temperature. If time is allowed for refolding and the disulfide bonds are reformed, virtually 100% of the original activity of BPTI can be recovered, indicating that the sequence of amino acids contains enough information to properly reestablish the folding of the polypeptide.

See also: [Thermodynamics of Protein Folding](#), [Dynamics of Protein Folding](#),

Polypeptide Sequence

Twenty different **amino acids** are polymerized to make **proteins**. A typical protein has hundreds of amino acids in a unique, defined **sequence** (**Figure 5.14**). The sequence of amino acids in a protein is called the primary structure of the protein.

Because each amino acid has unique chemical characteristics and a unique shape, the order in which amino acids are linked to make a protein - the primary structure - will determine the chemical characteristics *and* shape of the protein. Both are essential for a protein's function, so primary structure ultimately determines function. Furthermore, proteins evolve over time by changes in their **amino acid sequences**. Some changes are called conservative because they maintain the nature of the side chain (e.g., Asp replacing Glu). Others are called nonconservative changes because they alter the nature of the side chain (e.g., Asp replacing Ala).

Ultimately, the primary structure of proteins is encoded in the nucleotide base sequence of DNA. This base sequence is first transcribed into the corresponding base sequence in messenger RNA (**mRNA**). The base sequence in mRNA, in turn, is translated into the unique **amino acid sequence** of the protein via the genetic code.

Without a "blueprint," as specified in the nucleic acids, proteins would be made only as **random sequences** of amino acids. Duplicating a specific **sequence of amino acids** by random combinations would be extremely rare (1 in 20^{500} for a protein containing 500 amino acids).

Today, giant public databanks of polypeptide sequence information are readily available to anyone with online access. A few popular ones are listed below:

See also: [**Translation**](#), [**Genetic Code**](#)

Internet Links:

1. [**Entrez**](#)
2. [**OWL**](#)
3. [**Swiss-Prot**](#)
4. [**Molecules R Us**](#)



Figure 6.20: The thermal denaturation of ribonuclease.

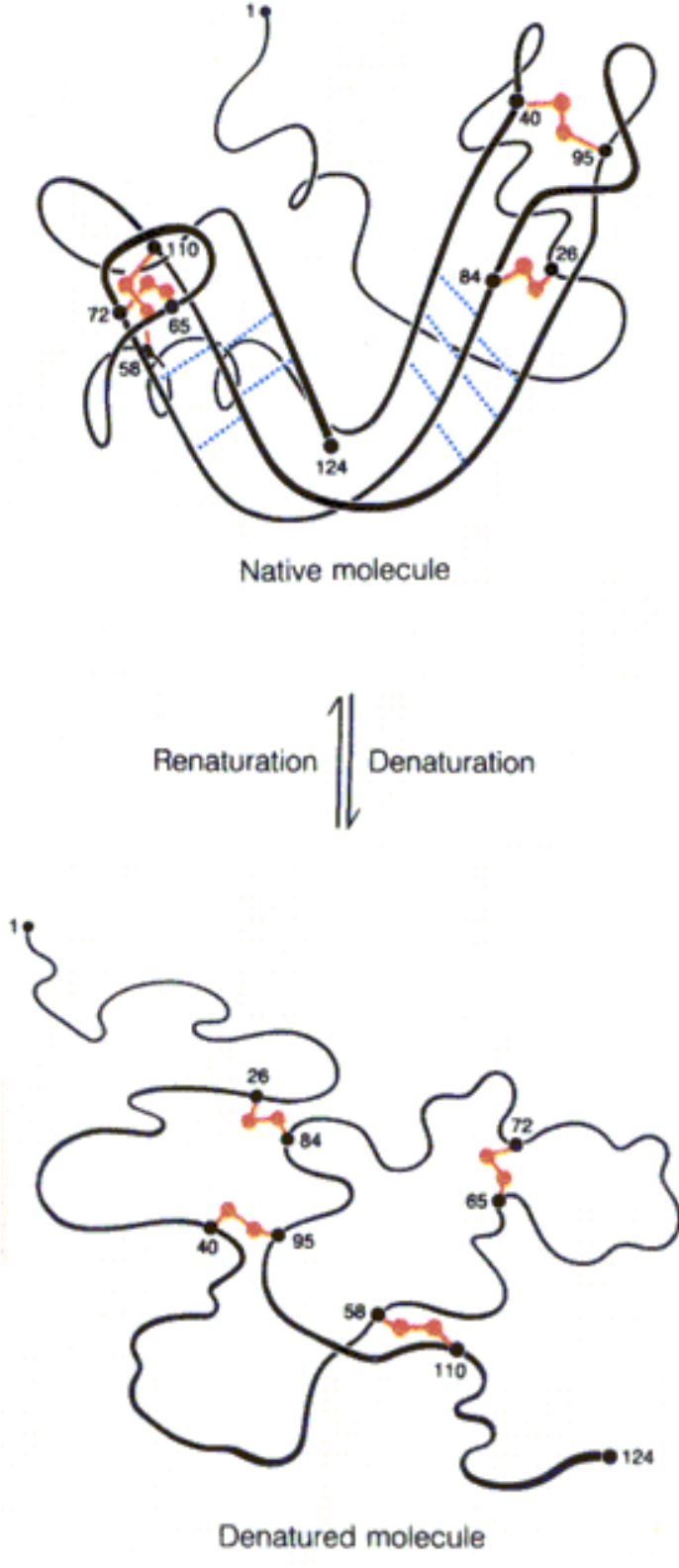

(a)

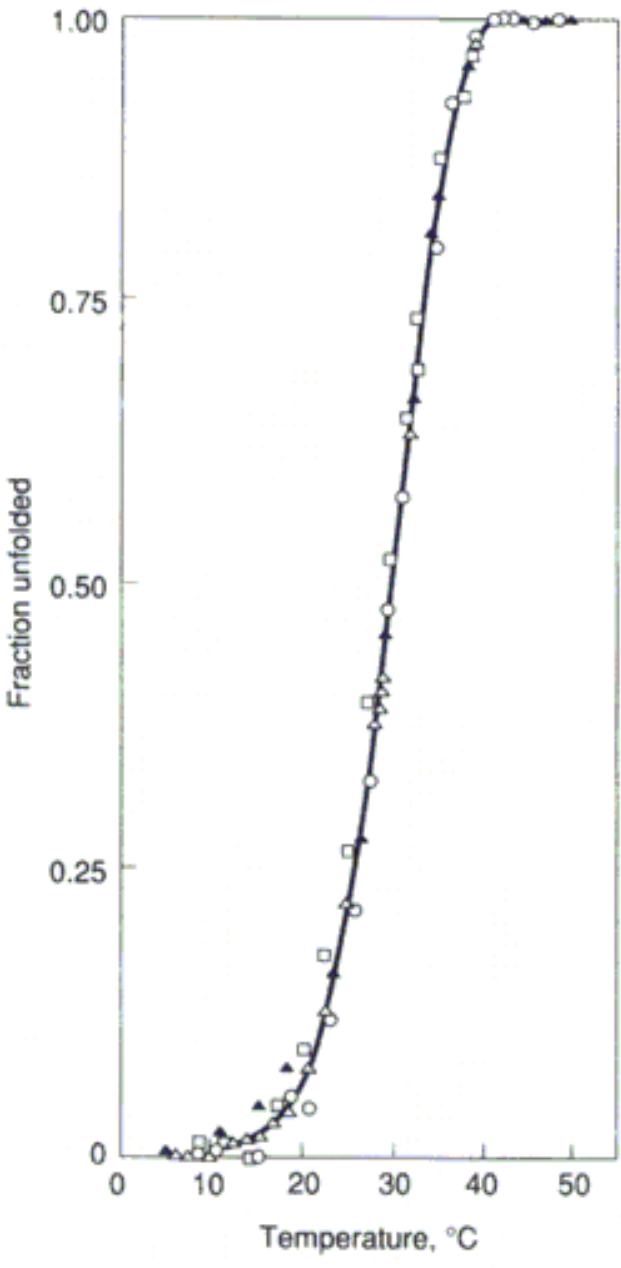

(b)

(b) Data from A. Ginsburg and W. R. Carroll, *Biochemistry* (1965) 4:2159-2174.

Figure 6.22: Contributions to the free energy of folding of globular proteins.

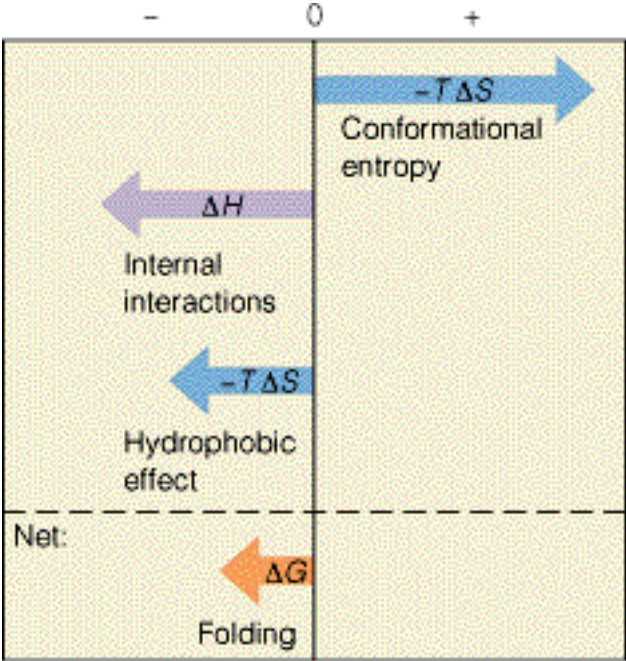

Thermodynamics of Protein Folding

Folding of a polypeptide chain is a thermodynamically favored process. Individual thermodynamic components relating to **folding** include the following:

Conformational Entropy - production of a single folded molecule from a multitude of random-coil conformations involves a decrease in randomness and thus a decrease in entropy. From $\Delta G = \Delta H - T\Delta S$, a negative ΔS makes a *positive* contribution to ΔG . This must be offset by either a negative ΔH or some other increase in entropy as a result of folding.

Internal Interactions - energetically favorable interactions between groups within the folded molecule. These interactions, which include charge-charge, internal hydrogen bonding, and van der Waals interactions, are the major source of the negative ΔH of folding.

Charge-Charge Interactions - occur between positively and negatively charged side chain groups. Interactions between oppositely charged groups (attraction) are also called salt bridges. Repulsive forces between like charges can also contribute to the overall structure.

Internal Hydrogen Bonds - interactions between amino acid side chains that are either good hydrogen bond donors (such as the hydroxyls of serine or threonine) or good acceptors (such as the carbonyl oxygens of **asparagine** or **glutamine**) (**Figure 6.21**). Though hydrogen bonds are relatively weak, the large number of them can make a considerable contribution to stability.

van der Waals Interactions - weak interactions between uncharged molecular groups in the tightly packed environment of a folded protein. The contributions of these interactions to the negative enthalpy of folding is diminished by giving up favorable interactions with water via folding.

The Hydrophobic Effect - interactions between hydrophobic regions of a protein, which actually increase entropy by destroying the ordered clathrate structures of water around these residues in the unfolded state. The hydrophobic effect is sometimes incorrectly called hydrophobic bonding. **Table 6.4** shows numerical values assigned to the relative hydrophobicities of the amino acids. In **Table 6.3**, the hydrophobic effect can be seen by the more positive ΔS values for cytochrome c and myoglobin.

Figure 6.22 helps illustrate the relative contributions to the free energy of folding of globular proteins.

See also: [Secondary Structure \(General\)](#), [Globular Proteins](#), [Factors Determining Secondary and Tertiary Structure](#), [Clathrate Structure of Water](#), [Enthalpy](#), [Entropy](#), [Interplay of Enthalpy and Entropy](#)

Asparagine

Asparagine is an α **amino acids** found in proteins. In mammals, **asparagine** is a non-essential amino acid, meaning it does not need to be present in the diet.

Asparagine is classified as an amide because it is an amide derivative of aspartic acid (Reaction 1 below). **Asparagine** functions as the protein anchor point for N-linked oligosaccharide-linked glycoproteins (See **Figure 16.16**).

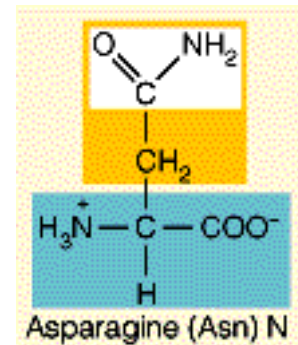

Reactions involving **asparagine**:

1. **Aspartic Acid** + **ATP** + NH₃ (**Glutamine**) \rightleftharpoons **Asparagine** + **AMP** + PPi + **Glutamate** (catalyzed by **Asparagine Synthetase** - the enzyme strongly prefers to use the amine group of glutamine over that of free ammonia)

2. **Asparagine** + H₂O \rightleftharpoons **Aspartic Acid** + NH₃ (catalyzed by Asparaginase)

One Letter Code	Three Letter Code	Molecular Wt. (Daltons)	Genetic Code Codons
N	ASN	114.11	AAU, AAC

See also: **Table 5.1, Genetic Code**, **Aspartic Acid**, **Transamination of Citric Acid Cycle Intermediates**, **Essential Amino Acids**

INTERNET LINKS: **Alanine and Aspartate Metabolism**

Figure 16.16: Structures of the major types of asparagine-linked (N-linked) oligosaccharides.

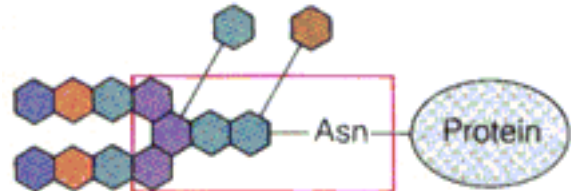

Complex

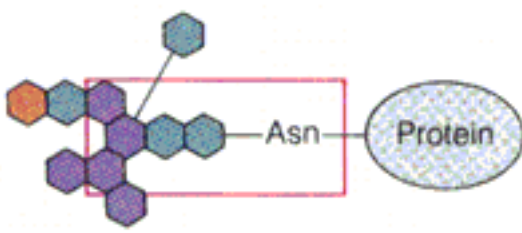



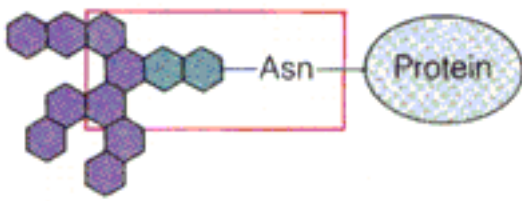

Hybrid



High-mannose

Key:

	GlcNAc		Man		Gal
	Sia		Fuc		

Asparagine Synthetase



Asparagine synthetase catalyzes conversion of aspartate to asparagine:



The reaction provides one way for cells to handle toxic ammonia and it also serves as a mechanism for making asparagine. Glutamine is a preferred substrate over ammonia.

Note that **asparagine synthetase** cleaves ATP to yield AMP + PPi, whereas glutamine synthetase (another enzyme for handling ammonia) yields ADP + Pi.

See also: [Utilization of Ammonia](#), [Glutamine synthetase](#)

Figure 20.12: Fates of the amino acid carbon skeletons.

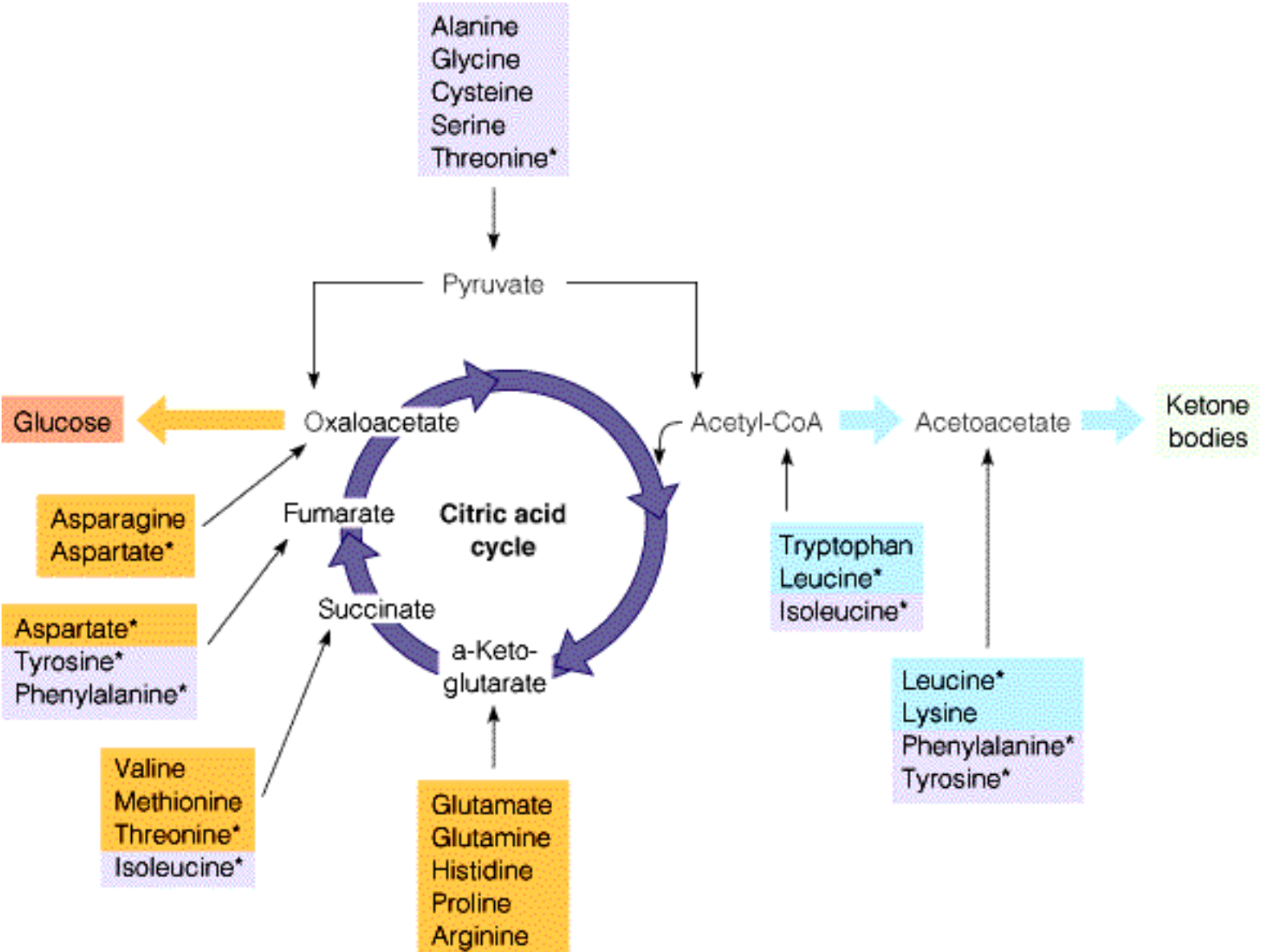

Unnumbered Item

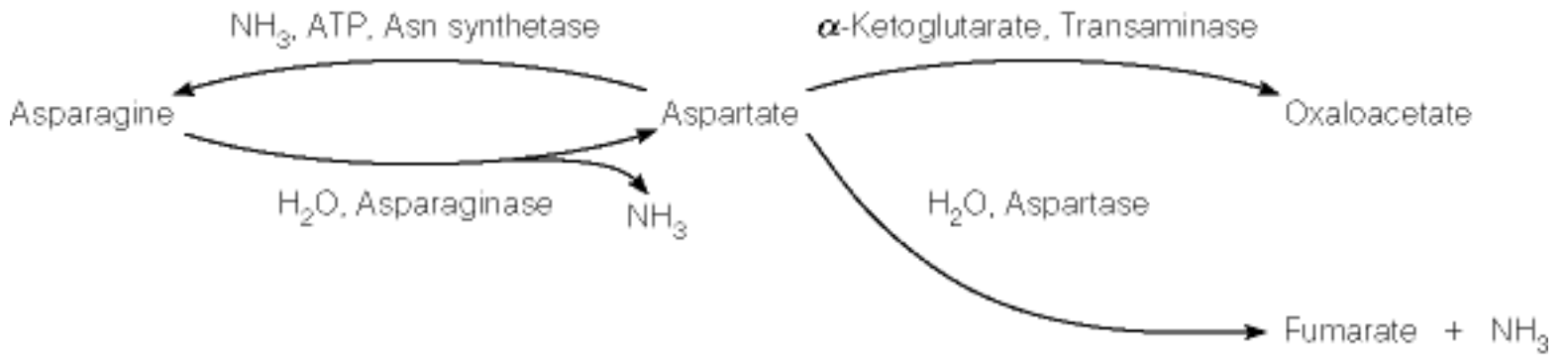

Transamination in Amino Acid Metabolism

Organisms vary widely in their ability to synthesize amino acids. Dietary amino acid requirements for organisms vary from all to none. Mammals require about half of the amino acids in their diet for growth and maintenance of normal nitrogen balance (see [here](#)). Amino acids that must be provided in the diet to meet an animal's metabolic needs are called **essential amino acids** ([Table 20.1](#)). Those that need not be provided because they can be biosynthesized in adequate amounts are called nonessential amino acids.

Transamination is the process by which an amino group, usually from glutamate, is transferred to an α -keto acid, with formation of the corresponding amino acid plus α -ketoglutarate. Thus, **transamination** provides a route for redistribution of amino acid nitrogen. **Transamination** reactions are catalyzed by **transaminases (aminotransferases)** (see [here](#)).

Aminotransferases utilize a coenzyme - **pyridoxal phosphate** - which is derived from vitamin B6. The functional part of pyridoxal phosphate (see [here](#)) is an aldehyde functional group attached to a pyridine ring. Catalysis involves a Schiff base intermediate (see [here](#)).

Transamination reactions have equilibrium constants close to one. Therefore, the direction of a **transamination** reaction proceeds in large part as a function of the intracellular concentrations of the reactants. This means that **transamination** can be used not only for amino acid synthesis, but also for degradation of amino acids that accumulate in excess of need. The reaction [here](#) shows how **transamination** is used for degradation of amino acids.

Most **aminotransferases** use glutamate/ α -ketoglutarate as one of the two amino/keto acid pairs involved. **Aminotransferases** involving aspartate/oxaloacetate and alanine/pyruvate are also quite abundant. Two important enzymes in the clinical diagnosis of human disease are serum glutamate-oxaloacetate transaminase (**SGOT**) and serum glutamate-pyruvate transaminase (**SGPT**):

SGOT: **Oxaloacetate** + **Glutamate** \leftrightarrow **Aspartate** + α -**Ketoglutarate**

SGPT: **Glutamate** + **Pyruvate** \rightarrow α -**Ketoglutarate** + **Alanine**

These enzymes, abundant in heart and liver, are released as part of the cell injury that occurs in myocardial infarction, infectious hepatitis, or other damage to either organ. Assays of these enzyme activities in blood serum can be used both in diagnosis and in monitoring the progress of a patient during treatment.

See also: [Citric Acid Cycle Intermediates in Amino Acid Metabolism](#) (from Chapter 21), [Amino Acids](#), [Utilization of Ammonia](#), [Amino Acid Degradation](#), [Ammonia Transport in the Body](#), [Coenzymes in Nitrogen Metabolism](#)



Metabolic Nitrogen Balance

Most organisms have little capacity to store **nitrogen**. Thus, animals must continually replenish **nitrogen** supplies through the diet to replace **nitrogen** lost through catabolism. When dietary protein is insufficient, proteins manufactured for other purposes, such as most muscle proteins, are broken down and not replaced.

A well-nourished adult is said to be in nitrogen equilibrium or **normal nitrogen balance** if

Dietary intake of nitrogen = Nitrogen loss (through excretion and other processes, such as perspiration)

Positive nitrogen balance occurs when:

Dietary intake of nitrogen > Nitrogen loss

Negative nitrogen balance occurs when:

Dietary intake of nitrogen < Nitrogen loss

See also: [The Nitrogen Cycle](#), [Utilization of Ammonia](#), [Urea Cycle](#)

The Nitrogen Cycle

Nitrogen is an essential element of biological molecules, such as amino acids, nucleotides, proteins, and DNA ([Figure 20.1](#)). All organisms can convert ammonia (NH_3) to organic **nitrogen** compounds (substances containing C-N bonds). The reduction of N_2 to NH_3 , on the other hand, which is called biological nitrogen fixation, can only be carried out by certain microorganisms, sometimes in symbiotic relationship with plants. The reduction of NO_3^- to NH_3 , however, is widespread among both plants and microorganisms.

Within the biosphere a balance is maintained between total inorganic and total organic forms of **nitrogen**. The conversion of inorganic **nitrogen** to organic **nitrogen**, which starts with **nitrogen** fixation and nitrate reduction, is counterbalanced by catabolism, denitrification, and decay ([Figure 20.2](#)).

Nitrogen availability is the factor limiting the fertility of most soils.

Nitrosomonas oxidizes ammonia to nitrite and *Nitrobacter* oxidizes nitrite to nitrate. Other bacteria, the denitrifying bacteria, convert ammonia to N_2 -just the opposite of the **nitrogen**-fixing bacteria.

See also: [Nitrogen Fixation](#), [Nitrate Utilization](#), [Urea Cycle](#)

INTERNET LINK: [Nitrate Uptake and Reduction](#)

Figure 20.1: Pathways of nitrogen metabolism (purple) in the general pattern of intermediary metabolism.

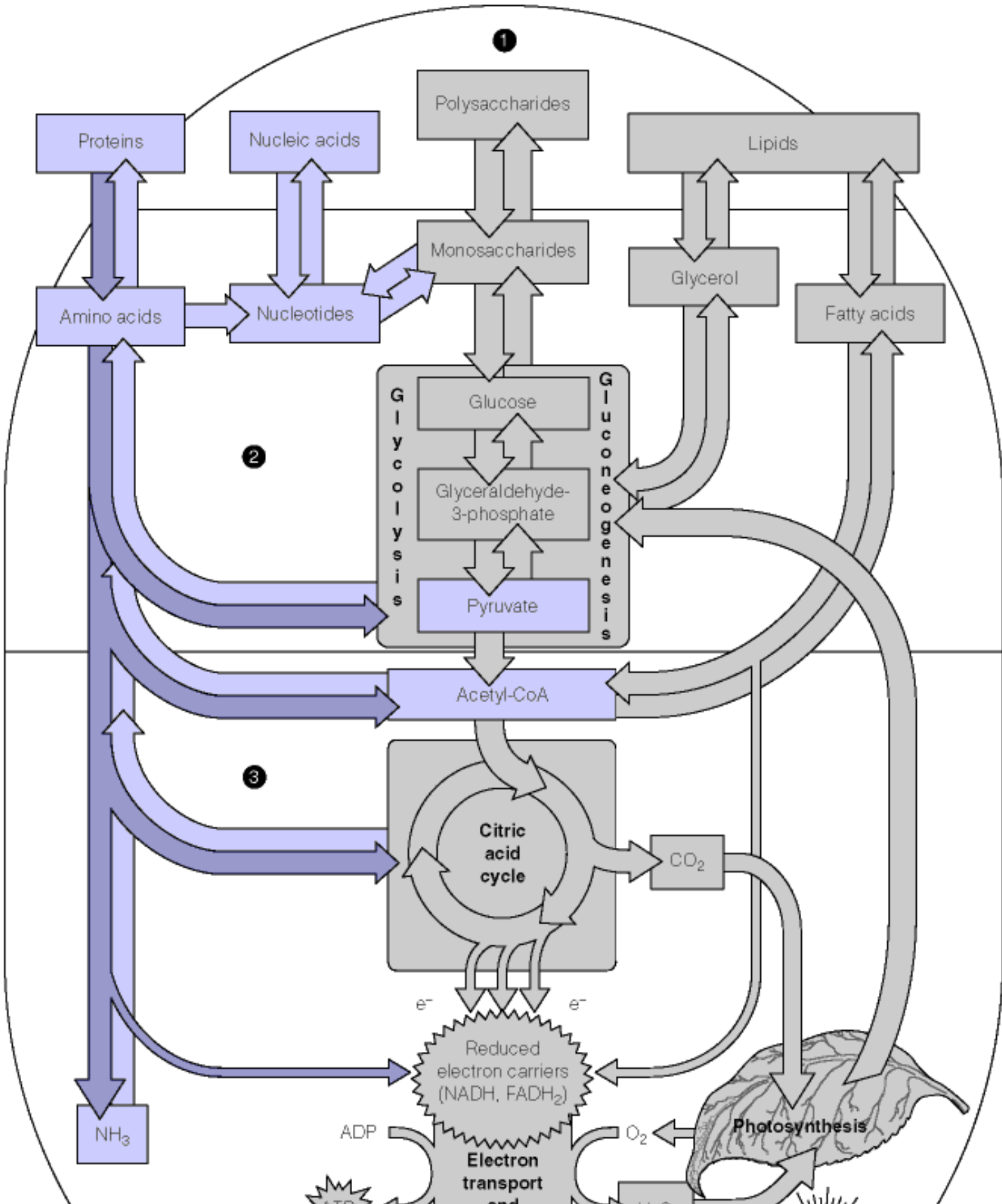

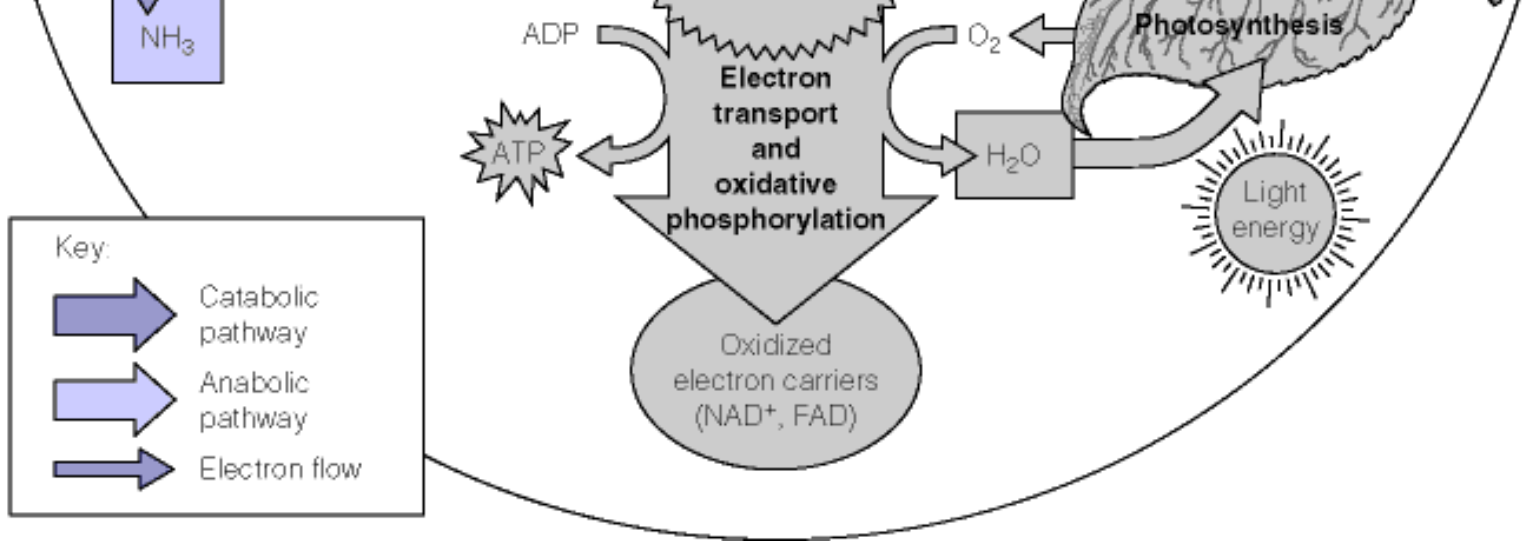
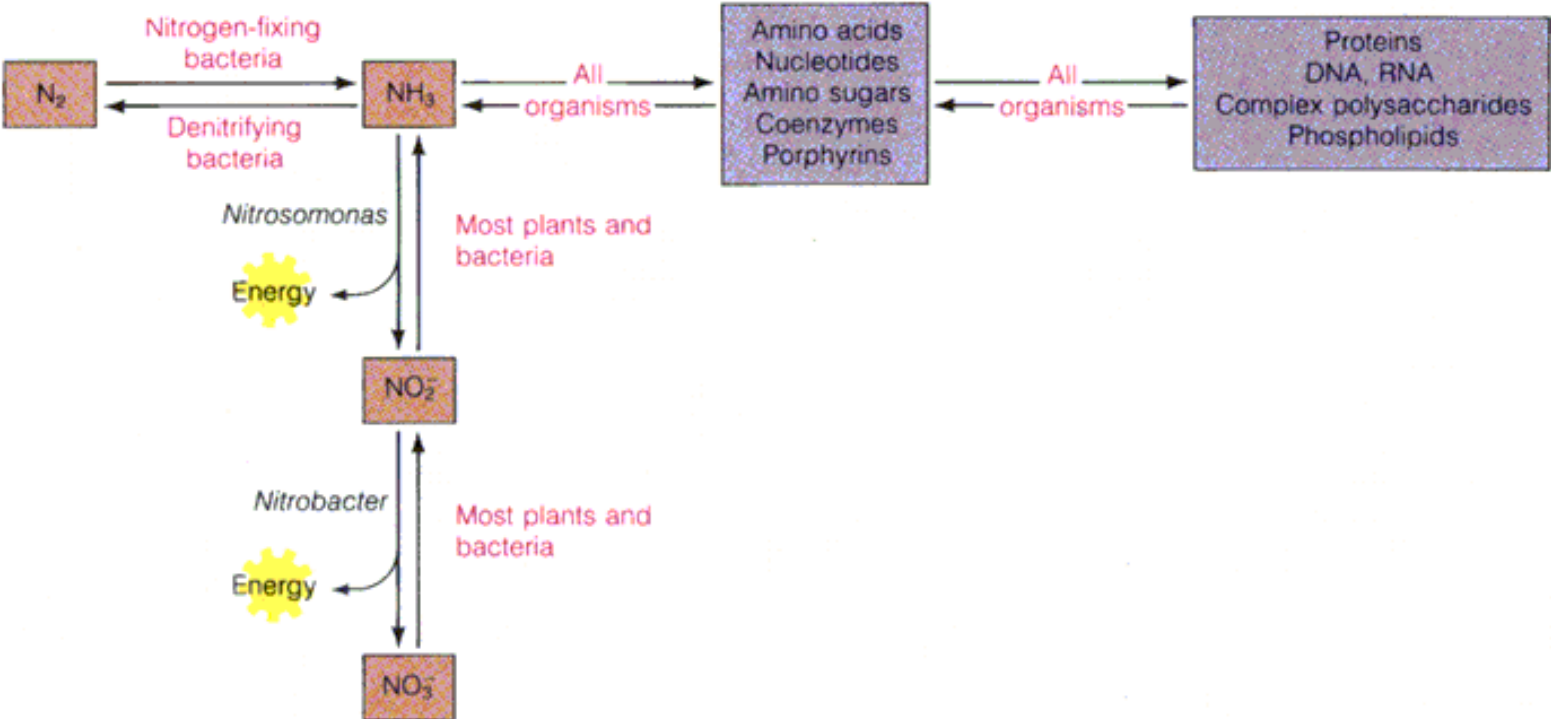

Figure 20.2: Relationships between inorganic and organic nitrogen metabolism.



Nitrogen Fixation

The reduction of atmospheric nitrogen (N₂) to ammonia (NH₃) is called biological **nitrogen fixation** and it occurs in relatively few living systems. These include some free-living soil bacteria, such as *Klebsiella* and *Azotobacter*, cyanobacteria, and *Rhizobium*, which is a symbiont on the roots of leguminous plants. The infecting bacterium assumes a modified form, called a bacteroid, inside the cells of infected plants.

Reducing nitrogen (as occurs in **nitrogen fixation**), requires energy and electrons with low-potential (electron carriers with very low E⁰). The enzymes involved are very sensitive to oxygen and must be studied only under anaerobic conditions. In root nodules of plants, the anaerobic environment is provided by the protein leghemoglobin, which binds any O₂ that makes its way into the nodules.

The mechanisms appear quite similar among the species examined to date. In *Klebsiella pneumoniae*, the overall reaction is as follows:



The number of ATPs required is actually uncertain. The low-potential electron carriers are either ferredoxin or flavodoxin (a low potential flavoprotein). Note that hydrogen is a product of the reaction.

The enzyme system for **nitrogen fixation** consists of two separate proteins. **Nitrogenase** (also called component I or molybdenum-iron protein) catalyzes the reduction of N₂. The other, **nitrogenase reductase** (also called component II or iron protein), transfers electrons from ferredoxin or flavodoxin to nitrogenase (**Figure 20.4**)

Both proteins contain iron-sulfur clusters. Nitrogenase also contains a tightly bound iron-molybdenum cofactor. Some variations on this theme are known. Some bacteria, such as *Azotobacter*, contain more than one nitrogenase complex. Of the three systems in *Azotobacter*, one uses vanadium instead of molybdenum and another uses only iron.

Crystal structures of nitrogenase and nitrogenase reductase (**Figure 20.5**) are now available and may help scientists understand how the enzyme system for **nitrogen fixation** operates.

See also: [The Nitrogen Cycle](#), [Nitrate Utilization](#), [Standard Reduction Potential](#) (from Chapter 15), [Ferredoxin](#)

INTERNET LINKS:

1. **Biological Nitrogen Fixation**
 2. **Nitrogen Fixation**
 3. **Component I**
 4. **Component II**
 5. **Nitrate Uptake and Reduction**
-

Figure 20.5: Structure of nitrogenase complex.

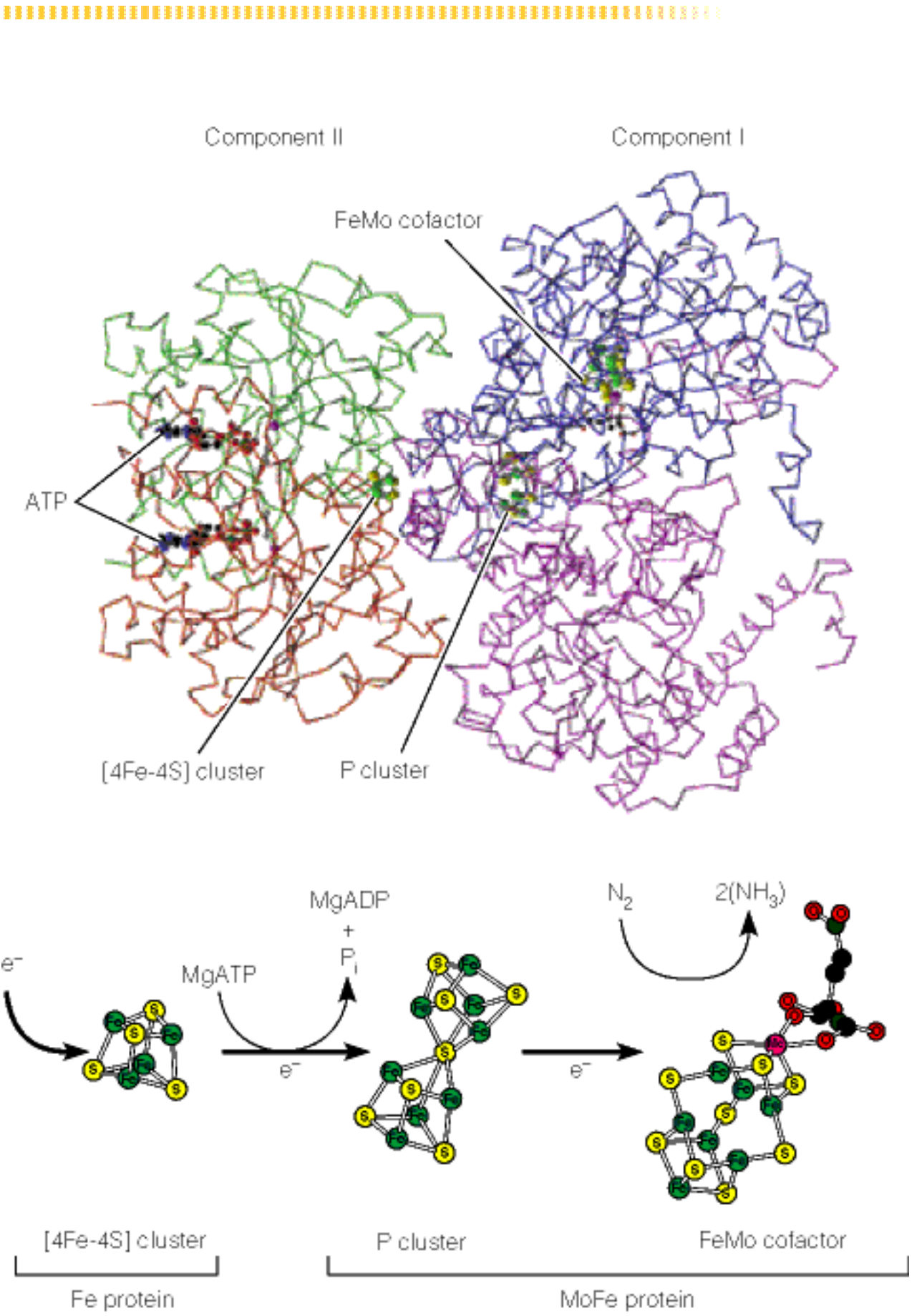

Courtesy of D. C. Rees and D. R. Dean, as reproduced in R. L. Rawls, Chem. Eng. News (1998), June 22 issue, pp. 29-32. Reprinted by permission of the author.

Nitrate Utilization

The ability to reduce **nitrate** (NO_3^-) to ammonia (NH_3) is common to virtually all plants, fungi, and bacteria. It occurs in the following four steps:

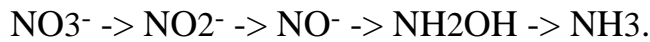

The first step, conversion of NO_3^- to NO_2^- , is catalyzed by a large and complex enzyme called **nitrate reductase**. **Nitrate reductase** is a multi-subunit enzyme with Mr of about 800 kD. It contains bound **FAD**, molybdenum, and a cytochrome called cytochrome 557 (which contains an Fe_4S_4 complex). **Nitrate reductase** carries out the following reaction:

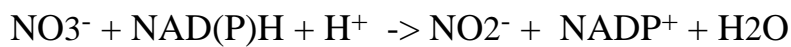

Plants use **NADH**. Fungi and bacteria use **NADPH**. The molybdenum is bound to a cofactor containing a pteridine ring to form molybdopterin (see [here](#)). All molybdenum-requiring enzymes except nitrogenase contain a structure similar to molybdopterin.

Another interesting molybdenum-containing enzyme is **dimethylsulfoxide reductase** ([Figure 20.6](#)). It contains two molecules of bound molybdopterin covalently linked to a **serine** residue in the enzyme.

The last three steps in the reduction of nitrate to ammonia are carried out by an enzyme called **nitrite reductase**. It contains one Fe_2S_2 center and one molecule of **siroheme**, a partially reduced iron porphyrin. The electron donor for each step is **ferredoxin**.

See also: [The Nitrogen Cycle](#), [Nitrogen Fixation](#), [Utilization of Ammonia](#)

INTERNET LINK: [Nitrate Uptake and Reduction](#)

Nitrate Reductase

Nitrate reductase catalyzes the first step in conversion of nitrate to ammonia, the reduction of nitrate to nitrite (NO₂⁻). The reaction multisubunit **nitrate reductase** enzyme, with Mr of about 800 kilodaltons, contains bound FAD, molybdenum, and a cytochrome called cytochrome 557 (which contains an Fe₄S₄ complex). **Nitrate reductase** carries out the overall reaction:

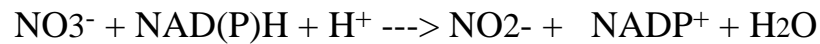

Plants use NADH as the electron donor, whereas fungi and bacteria use NADPH. The electrons are transferred to enzyme-bound FAD, then to cytochrome 557, then to molybdenum, and finally to the substrate.

See also: [The Nitrogen Cycle](#), [Nitrogen Fixation](#), [Utilization of Ammonia](#), [Dimethylsulfoxide Reductase](#), [Nitrite Reductase](#), [Siroheme](#), [Ferredoxin](#), [Figure 20.2](#)

INTERNET LINK:

1. [Nitrate Uptake and Reduction](#)
-

Dimethylsulfoxide Reductase

Dimethylsulfoxide reductase is a molybdenum-containing enzyme that catalyzes the conversion of dimethyl sulfoniopropionate (DMSP), produced by marine algae as an osmotic stabilizer and methylating agent, to dimethyl sulfide (DMS) ([Figure 20.6](#)). DMS is subsequently oxidized to dimethylsulfoxide (DMSO). **Dimethylsulfoxide reductase** contains two molecules of bound molybdopterin covalently linked to a serine residue in the enzyme.

See also: [The Nitrogen Cycle](#), [Nitrogen Fixation](#), [Nitrate Utilization](#), [Utilization of Ammonia](#), [Nitrate Reductase](#), [Dimethylsulfoxide Reductase](#), [Nitrite Reductase](#), [Siroheme](#), [Ferredoxin](#)

INTERNET LINKS:

1. [DMSO Reductase Family](#)
 2. [Nitrate Uptake and Reduction](#)
-

Figure 20.6: Environmental significance of DMSO reductase.

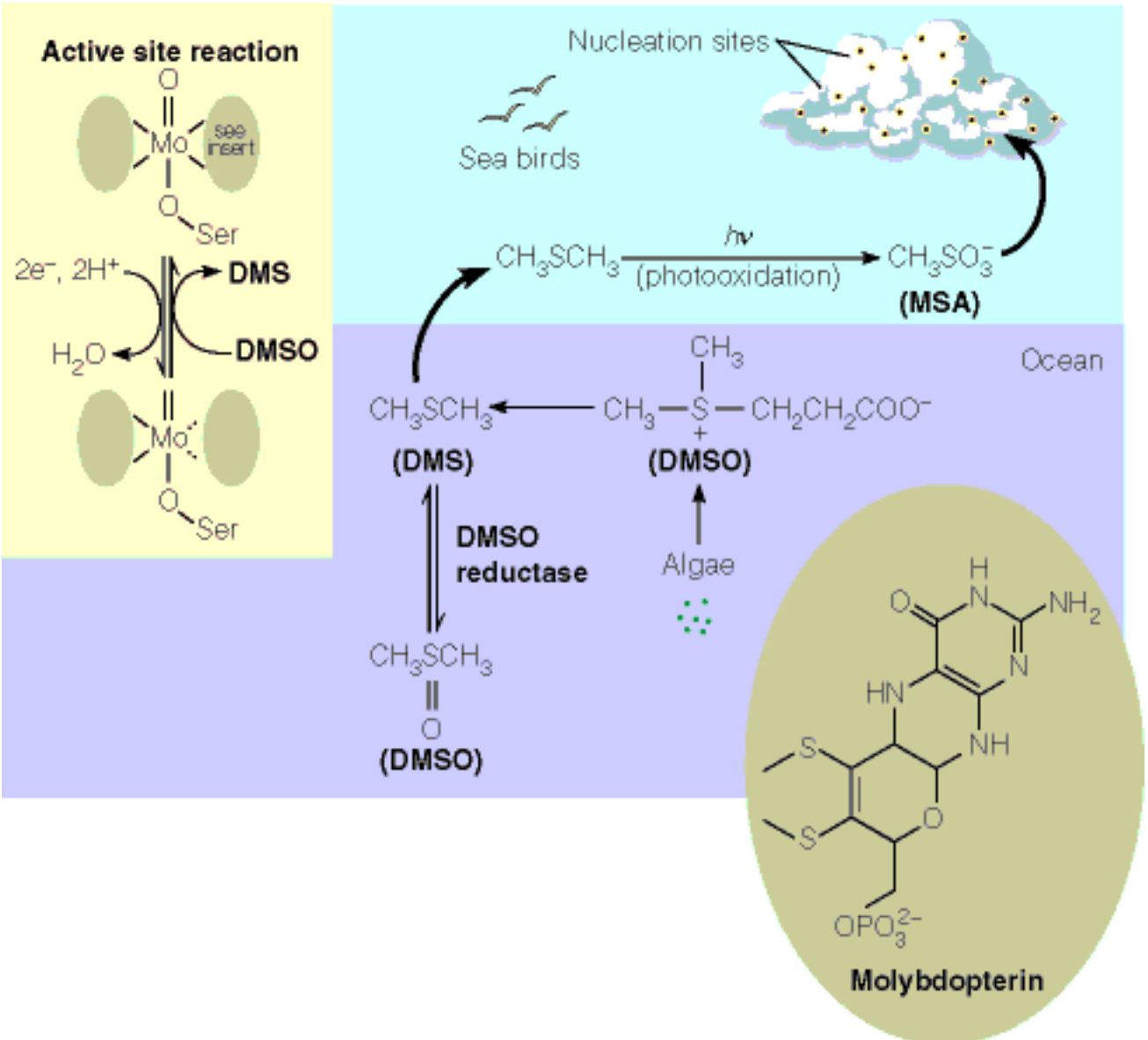

Courtesy of E. I. Steifel, Science (1998) 272:1599-1600, reprinted with permission. © 1996 AAAS.

Nitrite Reductase

The ability to reduce nitrate (NO_3^-) to ammonia (NH_3) is common to virtually all plants, fungi, and bacteria. It occurs in the following four steps:

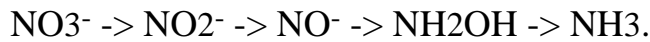

The first step, conversion of NO_3^- to NO_2^- , is catalyzed by a large and complex enzyme called [nitrate reductase](#).

The last three steps in the reduction of nitrate to ammonia are carried out by **nitrite reductase**. It contains one Fe_2S_2 center and one molecule of [siroheme](#), a partially reduced iron porphyrin. The electron donor for each step is [ferredoxin](#).

See also: [The Nitrogen Cycle](#), [Nitrogen Fixation](#), [Utilization of Ammonia](#), , [Dimethylsulfoxide Reductase](#)

INTERNET LINK: [Nitrate Uptake and Reduction](#)

Siroheme

Siroheme is a partially reduced iron porphyrin found in the enzyme [nitrite reductase](#).

See also: [The Nitrogen Cycle](#), [Nitrogen Fixation](#), [Utilization of Ammonia](#), [Nitrate Reductase](#), [Dimethylsulfoxide Reductase](#), , [Ferredoxin](#)

INTERNET LINK: [Nitrate Uptake and Reduction](#), [Metabolism of Sulfur-Containing Amino Acids](#)

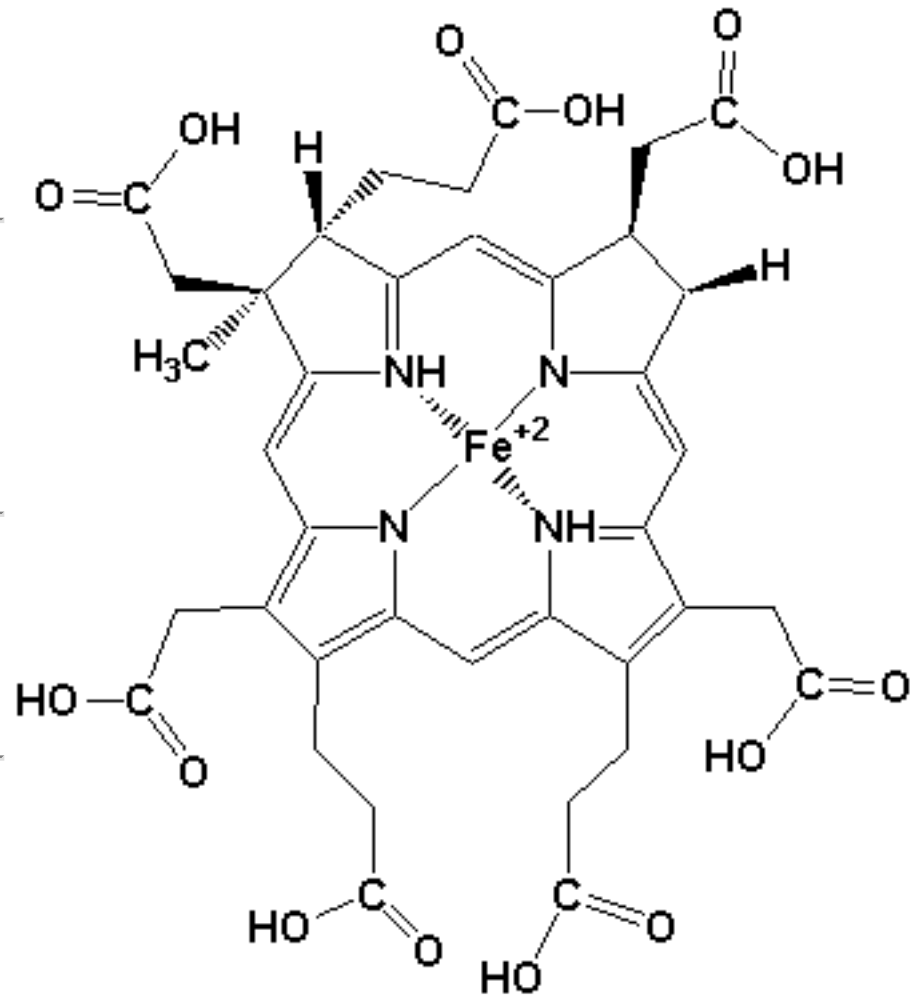

Siroheme

Unnumbered Item

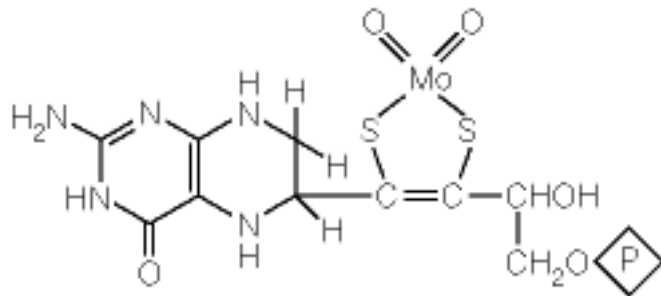

Molybdopterin

Standard Reduction Potential E_0'

Movement of electrons through the electron transport system (ETS) results in an oxidation (the complex losing electrons) and a simultaneous reduction (the complex accepting electrons). We use the term "redox" to describe these joint reactions:

Reductant + oxidant \rightleftharpoons Oxidized reductant (has lost electrons) + Reduced oxidant (has gained electrons)

In order for electrons to be transferred from the reductant to the oxidant, the oxidant must have a greater affinity for electrons than the reductant does. The **standard reduction potential, E_0'** is a measure of the affinity of a molecule (or partial reaction) for electrons measured at pH 7 and 25°C. [Table 15.1](#) shows **standard reduction potentials** for several reactions/species of interest in biochemistry. Species with a higher **standard reduction potential** tend to accept electrons from molecules with a lower **standard reduction potential**. Thus, electrons tend to move from cytochrome c(+2) to Cytochrome a (+3), because $E_0' = 0.25$ volts for the cytochrome c(+2) half-reaction whereas $E_0' = 0.29$ volts for the cytochrome a(+3) half-reaction. Keep in mind, though, that the movement of electrons from one compound to another based on E_0' values is only a tendency. If equal concentrations of the various species are present, the E_0' tells the direction electrons will flow. At other concentrations, the free energy change for the process (see below) must be calculated to determine the direction of electron movement.

See also: [Free Energy Changes from Oxidation/Reduction](#), [Oxidations and Energy Generation](#), [Electron Transport](#), [Cytochromes](#)

Oxidations and Energy Generation

When a compound is oxidized, it loses electrons. In biological systems, electrons from oxidation are generally transferred to electron-carrying molecules, such as NAD^+ or FAD to form NADH and FADH_2 , respectively. Note that NAD^+ and FAD are the oxidized forms of the molecules and NADH and FADH_2 are the reduced forms. Thus, biological oxidations generate reduced electron carriers. Reduced electron carriers donate their electrons to acceptor molecules and become reoxidized in the process. The acceptor molecules are reduced because the oxidation of one species (e.g., the reduced electron carrier) cannot occur without the simultaneous reduction of another species (e.g., the acceptor molecule).

The inner mitochondrial membrane contains a complex called Complex I that accepts electrons from NADH. In the process, the complex is reduced and NAD^+ is re-formed. Electrons from FADH_2 are transferred to a different mitochondrial complex, called Complex II. [Figure 15.3](#) and [Figure 15.2b](#) depicts the movement of electrons from Complex I and Complex II through the other electron carriers in the inner mitochondrial membrane.

The complexes of the inner mitochondrial membrane that shuttle electrons are called the electron transport system (ETS). After electrons pass through Complex IV, they are donated to oxygen along with protons to form water [Figure 15.2b](#). As electrons move through complexes I, III, and IV of the ETS, protons are "pumped" from the mitochondrial matrix to the intermembrane space. This creates a potential energy source, with a high concentration of protons in the intermembrane space and a relatively low concentration of protons in the mitochondrial matrix.

Pumps require energy to function. The "pumps" of the ETS chain derive their energy to transport protons from oxidation/reduction (called redox) reactions that occur as electrons move from one complex to another. To quantitate the amount of energy in these transfers, the standard reduction potential can be used.

See also: [Standard Reduction Potential](#), [Mitochondrial Structure and Function](#), [Free Energy Changes from Oxidation/Reduction](#), [Electron Transport](#), [NAD⁺](#), [NADH](#)

Unnumbered Item

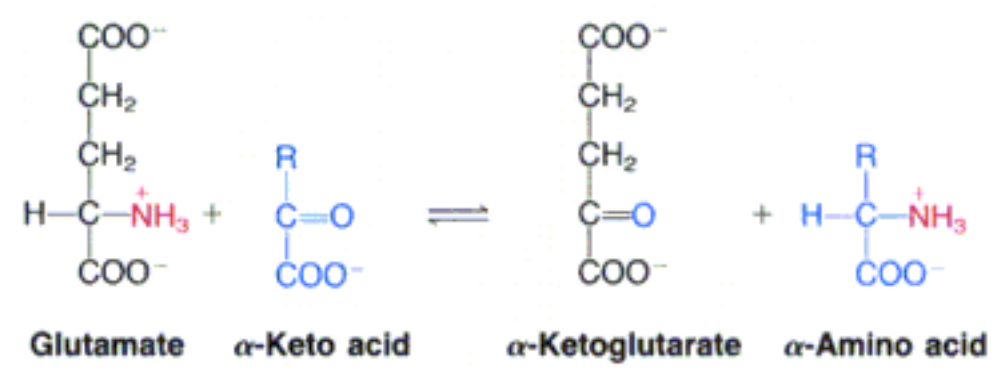

Pyridoxal Phosphate (PLP)

Pyridoxal phosphate participates in transaminations, decarboxylations, racemizations, and numerous modifications of amino acid side chains. All **pyridoxal phosphate**-requiring enzymes act via the formation of a Schiff base between the amino acid and coenzyme ([Figure 20.15](#)). A cation (a metal or a proton) is essential to bridge the phenolate ion of the coenzyme and the imino nitrogen of the amino acid. This bridging maintains the planarity of the structure, which is essential for catalysis. The most important catalytic feature of the coenzyme is the electrophilic nitrogen of the pyridine ring, which acts as an electron sink, drawing electrons away from the amino acid and stabilizing a carbanion intermediate.

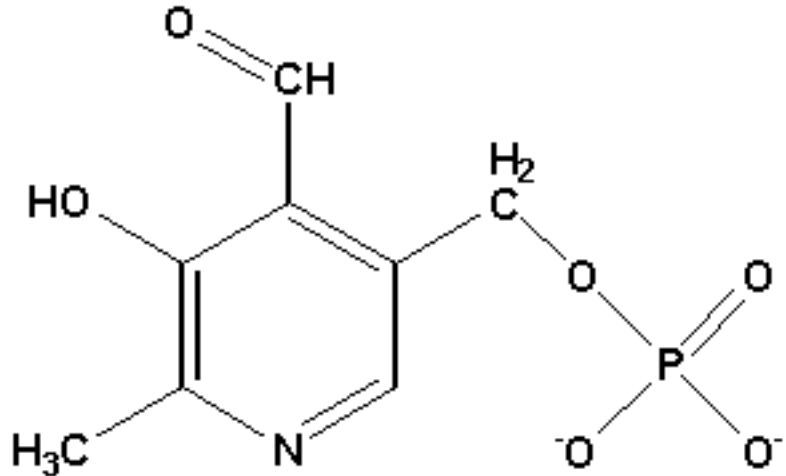

Pyridoxal Phosphate (PyP; Vitamin B6)

All known reactions of **PLP**-containing enzymes can be described mechanistically in the same way-formation of a planar Schiff base or aldimine intermediate, followed by formation of a resonance-stabilized carbanion with a quinoid structure, as shown in [Figure 20.15](#). Depending on the bond labilized, formation of the aldimine can lead to a transamination (as shown in [Figure 20.15](#)), to decarboxylation, to racemization, or to numerous side chain modifications.

See also: [Coenzymes in Nitrogen Metabolism](#)

Figure 20.15: Involvement of pyridoxal phosphate in transamination.

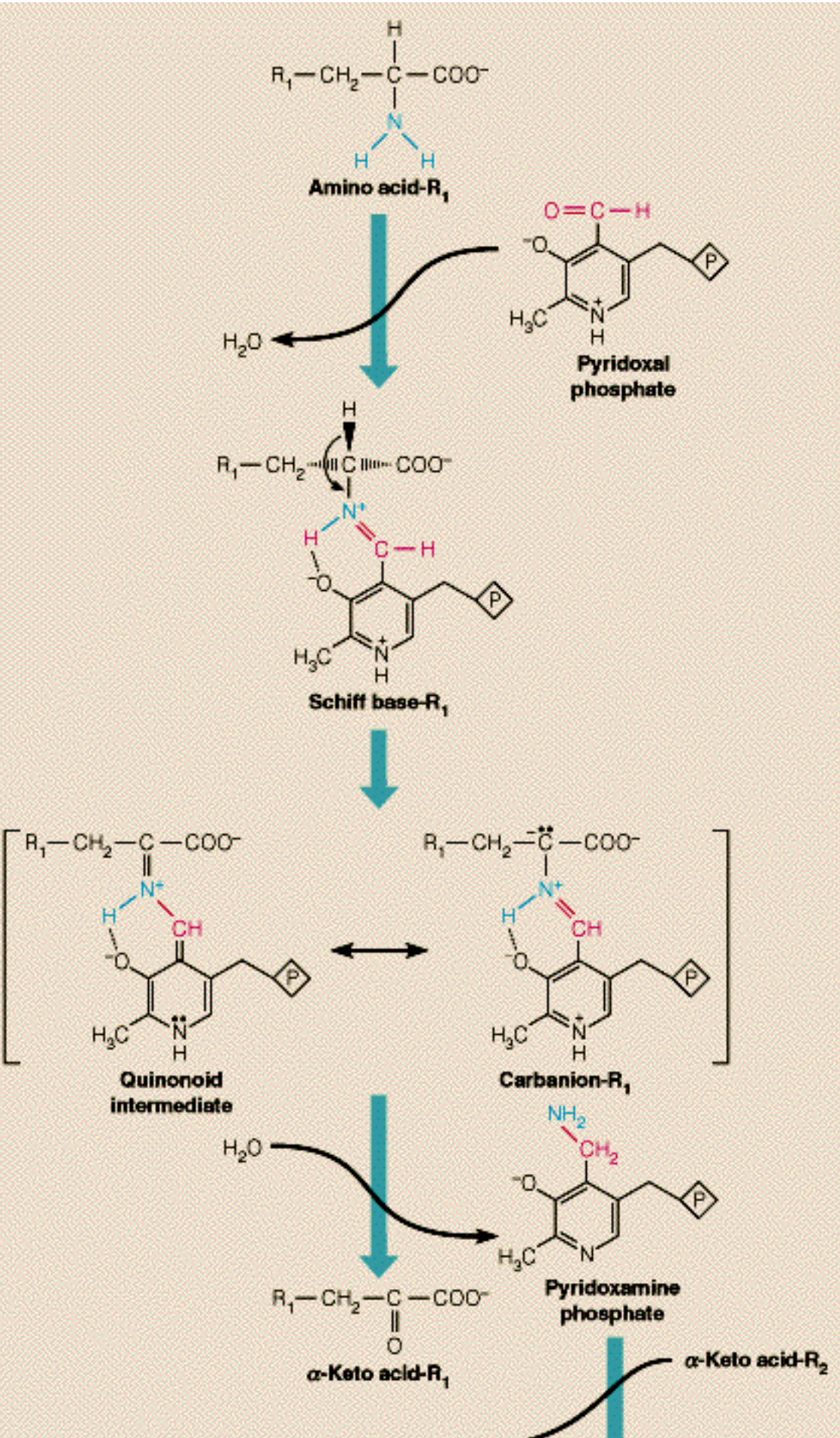

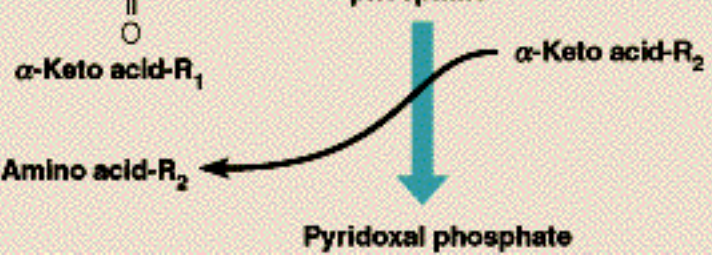

Coenzymes in Nitrogen Metabolism

Three families of coenzymes function primarily in amino acid and/or nucleotide metabolism. They include the following:

1. [Pyridoxal phosphate \(PLP\)](#)
2. [Tetrahydrofolate coenzymes](#)
3. [Vitamin B12 Coenzymes](#)

See also: [Amino Acid Degradation](#), [Transamination in Amino Acid Metabolism](#)

N-10-Formyltetrahydrofolate (10-Formyl-THF)

10-Formyl-THF is a source of single carbon units in *de novo* purine biosynthesis ([Figure 22.4](#) and [Figure 22.5](#)). Carbons donated by 10-formyl-THF to the purine rings are shown in [Figure 22.3](#).

See also: [De Novo Biosynthesis of Purine Nucleotides](#), [DHF](#), [THF](#), [5,10-Methylenetetrahydrofolate](#)

INTERNET LINK: [One Carbon Pool by Folate](#)

Figure 22.3: Low-molecular-weight precursors to the purine ring.

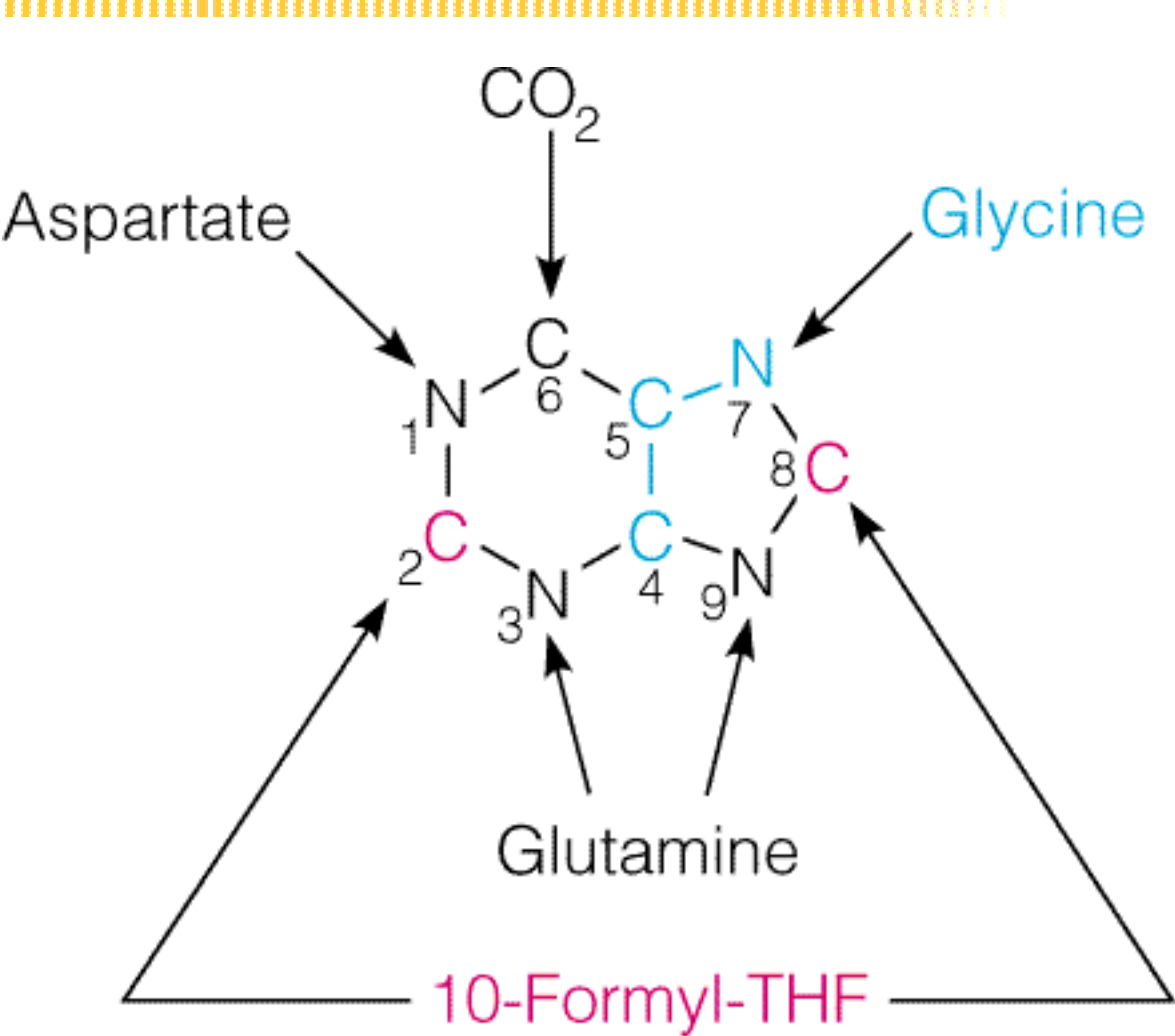

5-Methyltetrahydrofolate

5-Methyltetrahydrofolate is a folate metabolite derived from [5,10-methylenetetrahydrofolate](#) in the synthesis of [methionine](#).

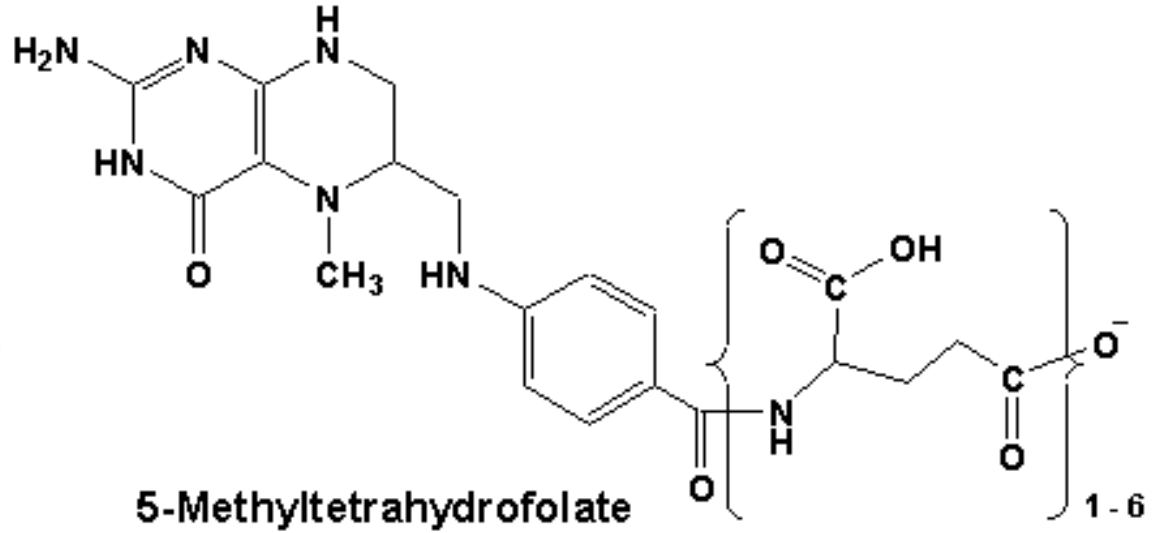

See also: [S-Adenosylmethionine and Biological Methylation](#), [Tetrahydrofolate](#)

[Coenzymes](#), [Metabolism of Sulfur-Containing Amino Acids](#), [Vitamin B12 Coenzymes](#)

INTERNET LINK: [One Carbon Pool by Folate](#)

Bacterial Motility - Rotating Proteins

The bacterial flagellum is a right-hand helical fiber, composed almost entirely of the fibrous protein flagellin. That is, the flagellum does not contain microtubules, actin, myosin (see [here](#)), or any contractile system. The flagellum itself rotates as a means of propelling the bacterium ([Figure 8.29](#)).

The driving force for rotation of the flagellum is a gradient of protons moving across the bacterial inner membrane. Thus, the flagellum behaves like an electric motor, in a sense. The motor runs at about 100 revolutions per second and requires the passage of about 1000 protons per revolution. Marine bacteria have similar rotary motors, but they use a sodium gradient, not a proton gradient, to power the motor.

The **flagellar motor** can be reversed, so it can operate either clockwise or counterclockwise. When the flagella are all turning counterclockwise, they pull together and propel the bacterium in a straight line (called running). When the flagella rotate clockwise, they fly out in a variety of directions, causing the bacterium to tumble randomly.

Bacterial chemotaxis is the phenomenon of moving in response to external chemical stimuli. Chemotactic bacteria (such as *E. coli*) move preferentially towards attractants, such as nutrients, and away from repellants, such as poisons. These motions can be accomplished by a combination of running and tumbling ([Figure 8.31](#)). In a neutral and uniform environment, brief periods (a few seconds) of running alternate with brief periods of tumbling, so the bacterium wanders randomly. In the presence of a gradient of either attractant or repellant, however, the bacterium delays tumbling, resulting in net motion towards the attractant or away from the repellant.

See also: [Flagellin](#), [Motions of Cilia and Flagella](#)

Figure 8.29: Structure of the bacterial flagellar motor.

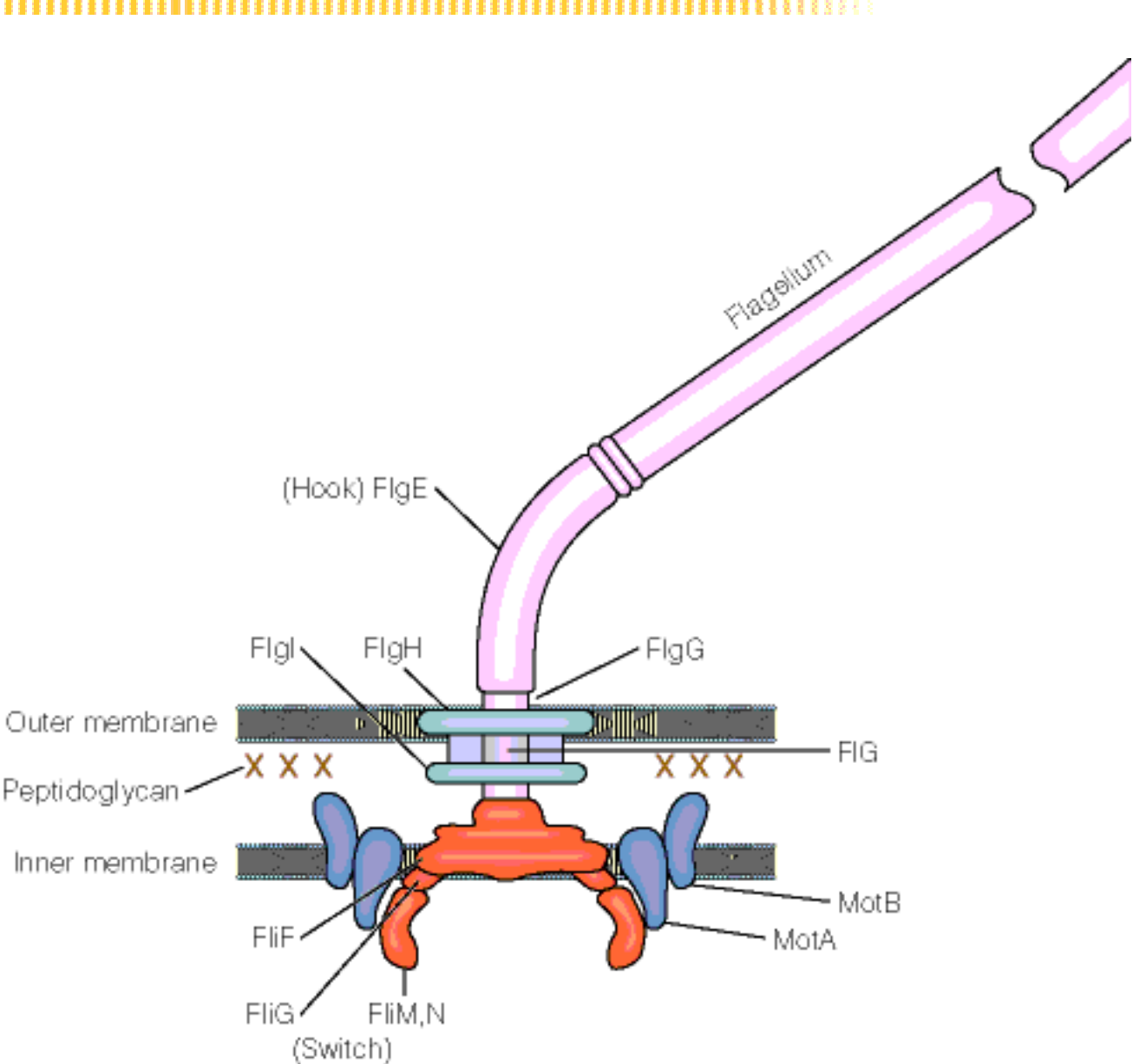

Adapted from H.C. Berg, Biophys. J. (1995) 68:163s-167s.

Figure 8.31: Chemotactic motion of bacteria.

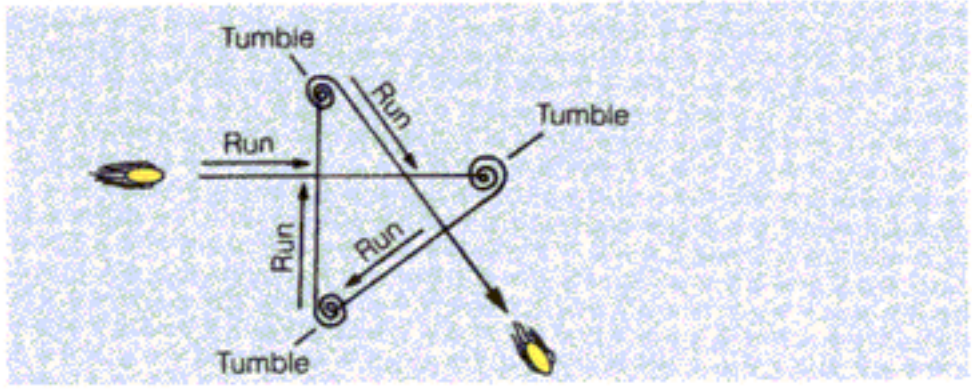

(a)

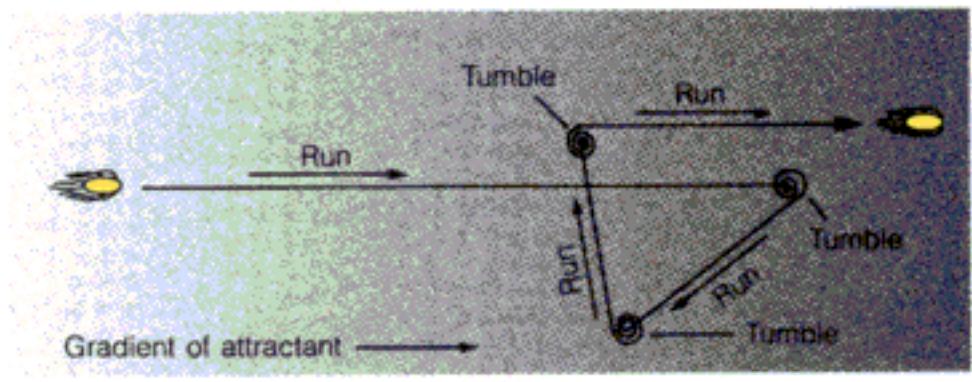

(b)

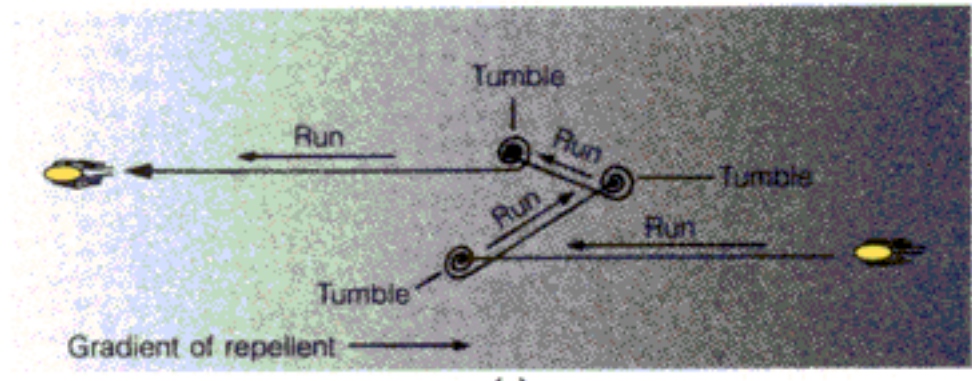

(c)

From W. M. Becker, L.J. Kleinsmith, and J. Hardin, *The World of the Cell*, 4th ed. (San Francisco, CA: Addison Wesley Longman, 2000) © Addison Wesley Longman, Inc.

Flagellin



Flagellin is a fibrous protein that composes most of the bacterial flagellum.

See also: [Motions of Cilia and Flagella](#), [Bacterial Motility - Rotating Proteins](#)

Motions of Eukaryotic Cilia and Flagella

Cilia and **flagella** are structures on the outer surface of eukaryotic cells that are involved in moving cells. **Cilia** are shorter than **flagella** and exert a coordinated rowing motion to move a microorganism through a solution. **Flagella** are longer and propel the cell by an undulatory motion.

Both **cilia** and **flagella** contain a highly organized bundle of microtubules called an **axoneme**, enveloped by an extension of the plasma membrane and connected to a basal body, an anchoring structure within the cell (**Figure 8.22b**).

Axonemes have microtubules arranged in a so-called 9 + 2 array—two central microtubules ringed by nine microtubule doublets (**Figure 8.22b**). The single microtubules in the center are complete, each having 13 protofilaments of $\alpha\beta$ tubulin dimers (**Figure 8.19**). By contrast, each of the nine surrounding doublets is composed of one complete microtubule (the A fiber) to which is fused an incomplete microtubule, carrying only 10 or 11 protofilaments (the B fiber). Closer inspection of electron micrographs reveals even greater complexity, as diagrammed in **Figure 8.23**. The outer doublets are periodically interconnected by a protein called **nexin** and carry at regular intervals sidearms composed of the protein **dynein**. In addition, radial spokes, each consisting of a head and an arm, project from the outer doublets to connect with the central pair.

About 200 polypeptides can be resolved by gel electrophoresis studies of isolated axonemes. Analysis indicates at least 6 proteins in the spoke heads and 11 others in the arms of the spokes. Much of this apparatus seems to be directly involved in the beating motions of cilia and flagella.

If ATP is added to isolated axonemes, adjacent doublets can be seen to slide past one another. The best current model holds that this sliding occurs by "walking" of the dynein sidearms along the adjacent doublet (**Figure 8.24**). Doublets slide past each other first on one side of the axoneme and then the other, with the length of the slide limited by the central spokes and nexin connectors. In this way, the sliding of doublets is transformed into back-and-forth bending of the whole cilium or flagellum (**Figure 8.24**). If connections within the axoneme are removed by careful proteolysis, ATP simply causes axonemes to extend and thin, as the outer doublets slide past one another with no stopping point.

It has been demonstrated that dynein has ATPase activity, with binding of ATP associated with the breaking of dynein cross-bridges. Thus, there are similarities between the mechanisms of the beating of cilia and flagella and the ATP-driven walking of myosin heads along the actin fiber, but there appears to be no relationship between the two systems at the level of protein structure.

See also: [Microtubule Systems](#), [Intracellular Transport of Materials](#)

Axoneme

Cilia and flagella contain a structure called an **axoneme** at their centers (see **INTERNET LINK [here](#)**). An **axoneme** is composed of microtubules.

The internal structure of the **axoneme** is truly remarkable. The most obvious feature is the arrangement of microtubules known as a 9 + 2 array: Two central microtubules ringed by nine microtubule doublets. The single microtubules in the center are complete, each having 13 of α/β **tubulin** dimers. By contrast, each of the nine surrounding doublets is composed of one complete microtubule to which is fused an incomplete microtubule, carrying only 10 or 11 protofilaments. Closer inspection of electron micrographs reveals even greater complexity, as diagrammed in **Figure 8.23**. The outer doublets are periodically interconnected by a protein called **nexin** and carry at regular intervals sidearms composed of the protein **dynein**. In addition, radial spokes, each consisting of a head and an arm, project from the outer doublets to connect with the central pair.

See also: **[Motions of Cilia and Flagella](#)**, **[Microtubule Systems](#)**

INTERNET LINK: **[Normal Human Axoneme](#)**

Tubulin

A class of motile systems completely different from and unrelated to the actin-myosin contractile systems is used in cellular structures as diverse as the mitotic spindle, protozoan and sperm flagella, and nerve axons. These systems are constructed from microtubules, very long, tubular structures built from a helical wrapping of the protein **tubulin** ([Figure 8.19](#)). There are two kinds of **tubulin** subunits, α and β , each of molecular weight 55,000. They are present in equimolar quantities in the microtubule, which can be considered a helical array of α - β dimers. Alternatively, we can view the microtubule as consisting of 13 rows, or protofilaments, of alternating α and β subunits. Because the α and β units are asymmetrical proteins, with a defined and reproducible orientation in the fiber, the microtubule has a definite sense of direction.

The assembly of microtubules bears certain similarities to that of actin, but **GTP** is required rather than **ATP**. The α - β dimers bind GTP and then associate to form oligomers. These oligomers form nucleation sites for the growth of microtubules ([Figure 8.20](#)). One end, called the plus end, grows more rapidly than the other, minus end. As in actin polymerization, the nucleotide is hydrolyzed but is held in the filament. The final assembly of a functional microtubule usually involves the binding of other proteins to its surface.

See also: [Microtubule Systems](#), [Motions of Cilia and Flagella](#), [Intracellular Transport of Materials](#), [Actin and Myosin](#)

INTERNET LINK: [Tubulin](#)

Figure 8.19: Portion of a microtubule.

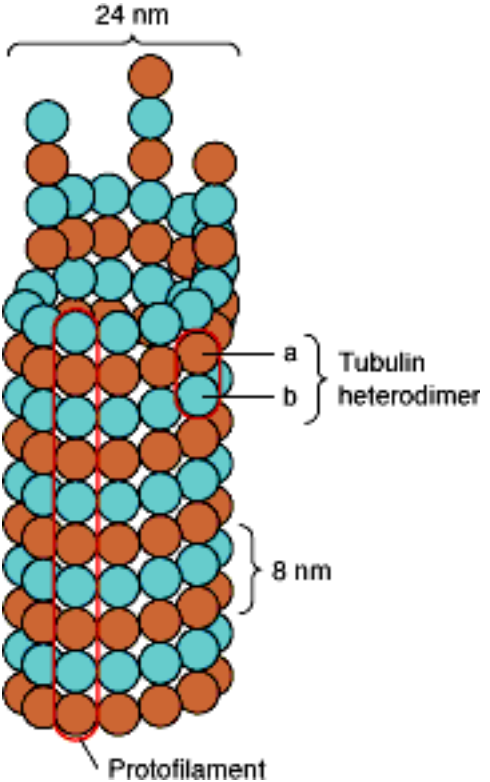
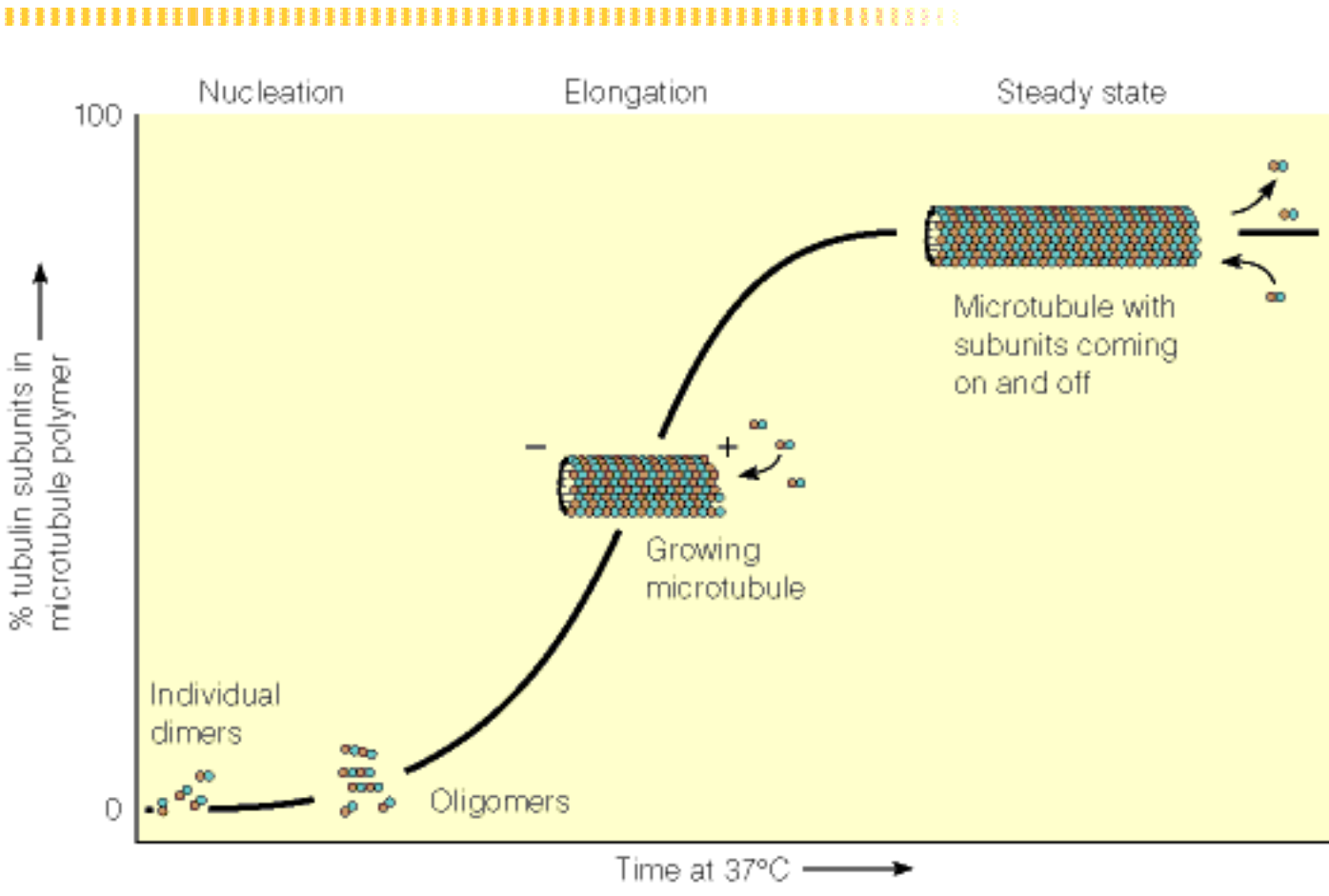

Figure 8.20: Assembly of microtubules.



From Alberts et al., Molecular Biology of the Cell (New York: Garland Publishing, 1994), fig. 16.23. Copyright © 1994 Garland Publishing.

Microtubule Systems

Microtubules are systems of very long tubular structures built from a helical wrapping of tubulin ([Figure 8.19](#)). **Tubulin** is involved in motility within cells, such as in the mitotic spindle, flagella, and nerve axons. Tubulin is composed of two subunits, α and β , each of molecular weight 55,000. They are present in equimolar amounts in tubulin as $\alpha\beta$ dimers.

Assembly of **microtubules** requires energy from the hydrolysis of **GTP**. One end of the **microtubule** grows more rapidly, and is called the plus end. The other end is called the minus end. Assembly of **microtubules** is depicted in [Figure 8.20](#). The final assembly of a functional **microtubule** usually involves the binding of other proteins, called **microtubule-associated proteins** (MAPs) to its surface. MAPs may stabilize **microtubule** structure and/or promote the association of **microtubules** into bundles.

The MAP called τ (tau) is found in neuronal tissue. Phosphorylation of τ dissociates τ from microtubules, destabilizing the microtubules. Hyperphosphorylation of τ has a much more dramatic effect, resulting in the formation of tangles of τ -filaments in neural axons, one of the major cellular symptoms of Alzheimer's disease.

The mitotic spindle is composed mainly of **microtubules**. The mitotic spindle contains **microtubules** that have a variety of functions ([Figure 8.28](#)). Some, called polar **microtubules**, extend between the centrioles, apparently pushing them apart. Others, the kinetochore **microtubules**, are attached to the kinetochores of the individual [chromosomes](#) and seem to pull the chromatids to the poles in telophase.

See also: [Motions of Cilia and Flagella](#), [Intracellular Transport of Materials](#), [Bacterial Motility-Rotating Proteins](#)

Figure 8.28: Microtubules in the mitotic spindle.

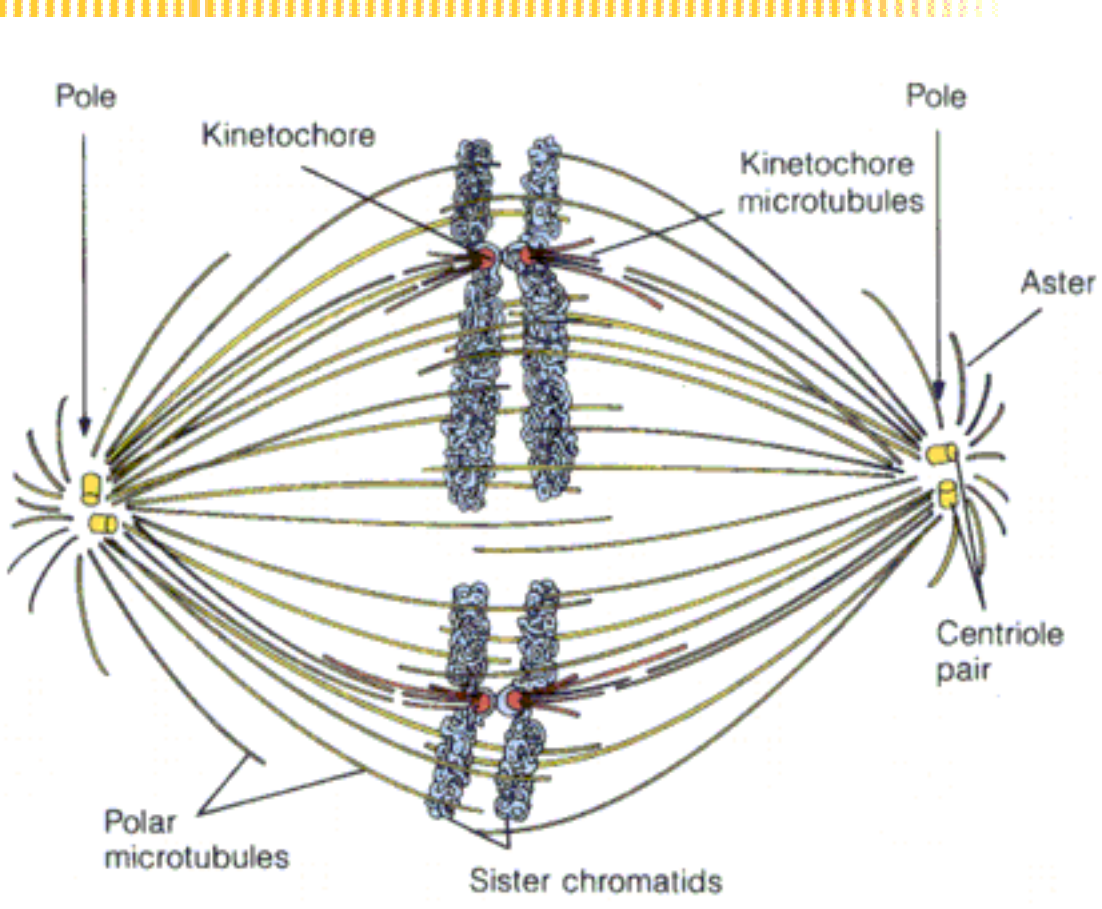
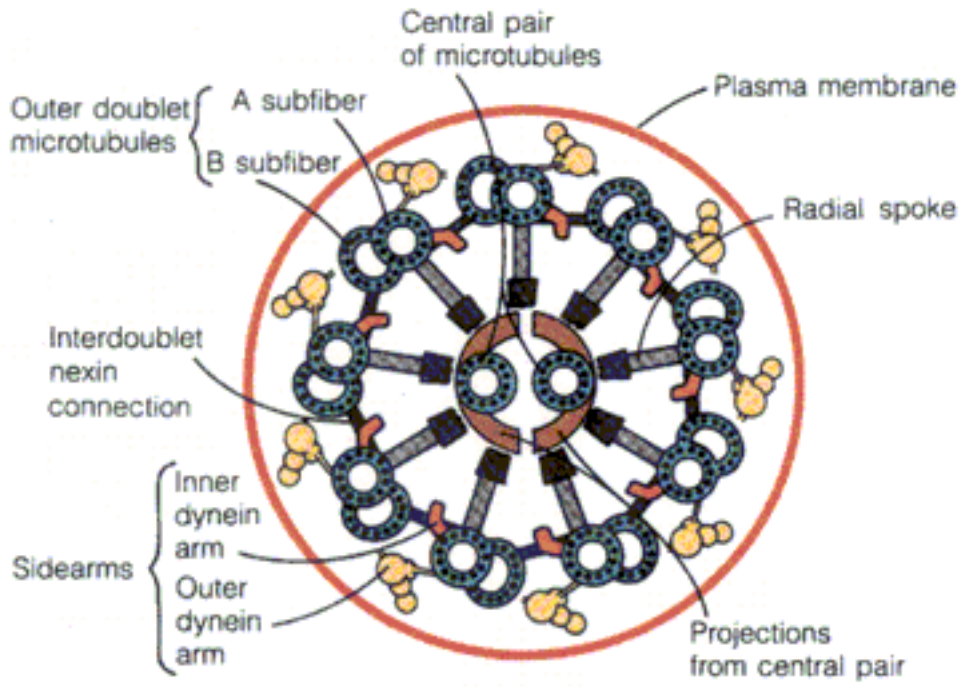

Figure 8.23: Diagram of the cross section of an axoneme.



Nexin



Nexin is a protein found in the axoneme of flagella and cilia. It serves to periodically interconnect the outer doublets of the structure ([Figure 8.23](#)).

See also: [Motions of Cilia and Flagella](#), [Axoneme](#), [Dynein](#)

Dynein

Cilia and flagella contain a structure called an **axoneme** at their centers (see [INTERNET LINK here](#)). An **axoneme** is composed of microtubules. The internal structure of the axoneme is truly remarkable. The most obvious feature is the arrangement of microtubules known as a 9 + 2 array: two central microtubules ringed by nine microtubule doublets. The single microtubules in the center are complete, each having 13 of α/β **tubulin** dimers. By contrast, each of the nine surrounding doublets is composed of one complete microtubule to which is fused an incomplete microtubule, carrying only 10 or 11 protofilaments. Closer inspection of electron micrographs reveals even greater complexity, as diagrammed in [Figure 8.23](#). The outer doublets are periodically interconnected by a protein called **nexin** and carry at regular intervals sidearms composed of the protein dynein. In addition, radial spokes, each consisting of a head and an arm, project from the outer doublets to connect with the central pair.

Another form of **dynein**, called cytoplasmic dynein, is a molecular motor that transports materials from the plus end of the microtubule toward the minus end. The protein **kinesin** transports them in the opposite direction.

See also: [Motions of Cilia and Flagella](#), [Intracellular Transport of Materials](#), [Microtubule Systems](#)

Kinesin



Kinesin is a cytoplasmic protein that functions in the cell as a molecular motor, moving things from the minus end of microtubules towards the positive end. This is the opposite direction from which [dynein](#) transports items.

See also: [Intracellular Transport of Materials](#), [Microtubule Systems](#)

Intracellular Transport of Materials

Some proteins and organelles are rapidly transported over long distances along microtubules, which serve as tracks that direct and facilitate the motion. Study of transport along axons (long projections that allow one nerve to contact another) reveals small vesicles or whole organelles that can actually be seen moving along microtubule bundles in both directions. Two "molecular motors" are involved. One, called cytoplasmic **dynein**, resembles the dynein involved in the motion of cilia and flagella. It is involved in transport from the plus end of the microtubule toward the minus end. The other molecular motor protein is called **kinesin**. It transports objects in the opposite direction from cytoplasmic dynein. The two proteins are similar in structure and resemble **myosins** (**Figure 8.26**).

Careful studies of the motion of kinesin and dynein on microtubules indicate that they "walk" along the microtubule track, with a step size of about 8 nm—the distance from one tubulin dimer to the next. **Figure 8.27** depicts a model for the motion of kinesin on a microtubule.

Evidence exists for another kind of transport in the cytoplasm. This one involves not microtubules, but actin fibers. Thus, microtubules may represent the "superhighways" for intracellular transport, whereas **actin** fibers may serve as the "country roads".

See also: [Motions of Cilia and Flagella](#), [Microtubule Systems](#), [Dynein](#), [Kinesin](#)

Figure 8.26: The kinesin dimer.

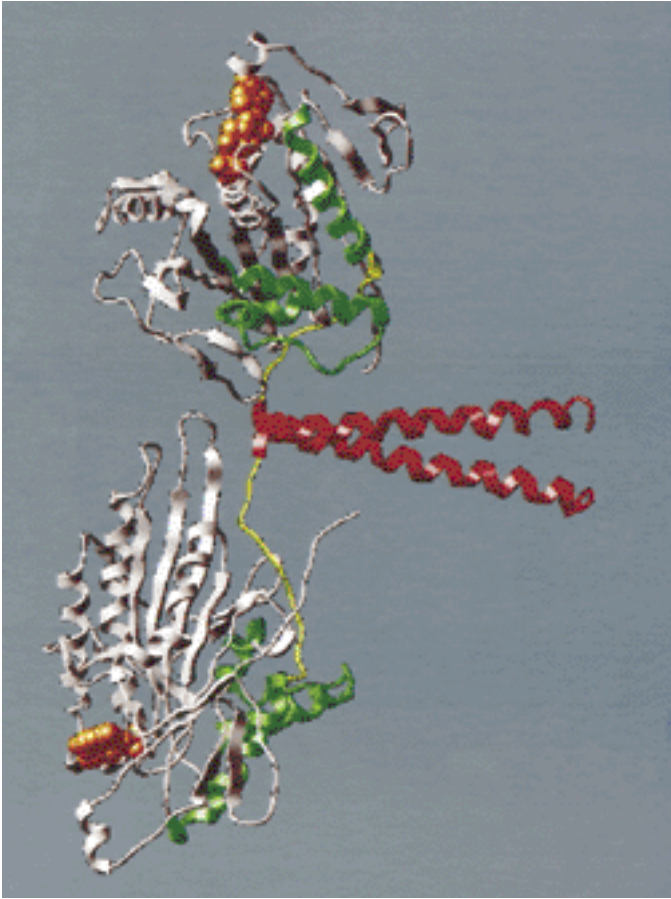

Adapted from E. Mandelkow and A. Hoenger, *Curr. Opin. Cell. Biol.* (1999) 11:34-44.

Figure 8.27: A model for the motion of kinesin on a microtubule.

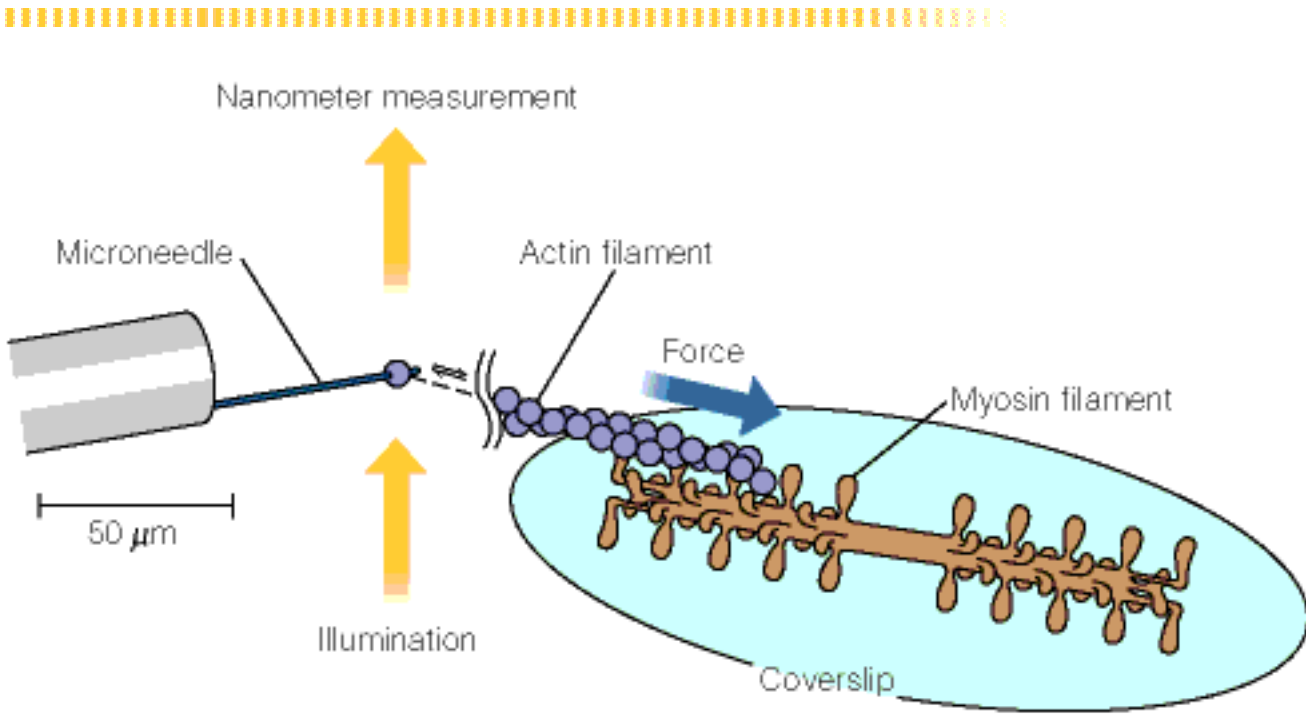
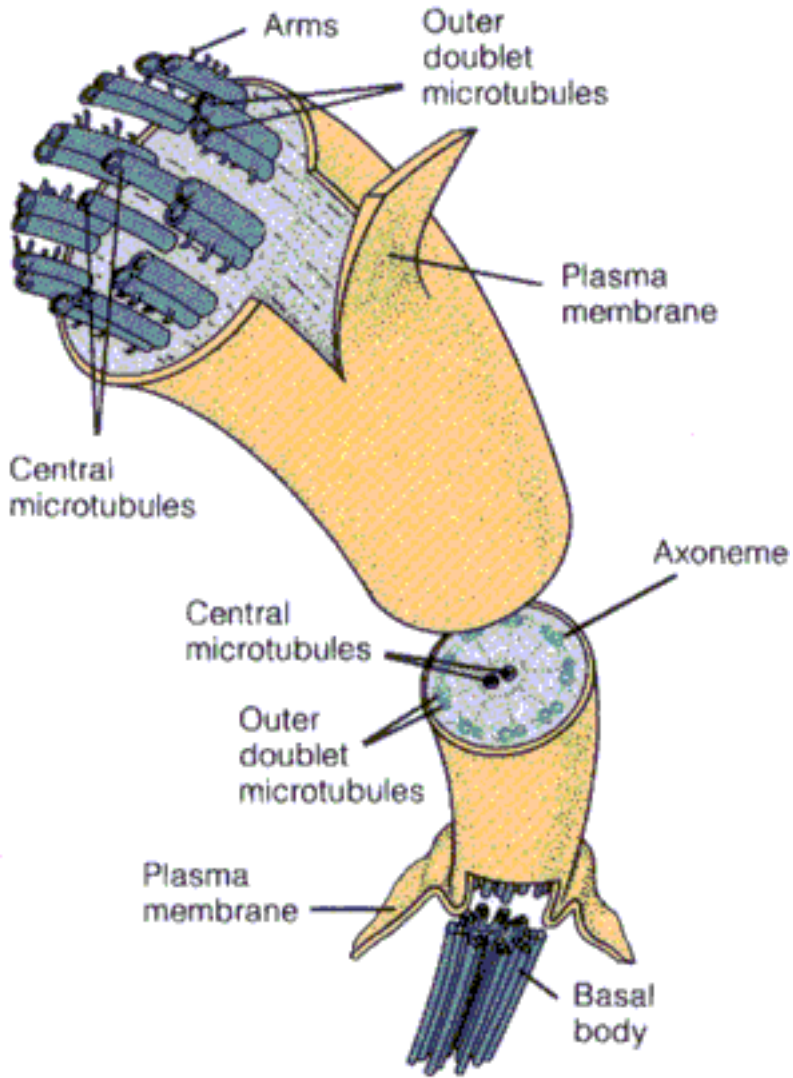
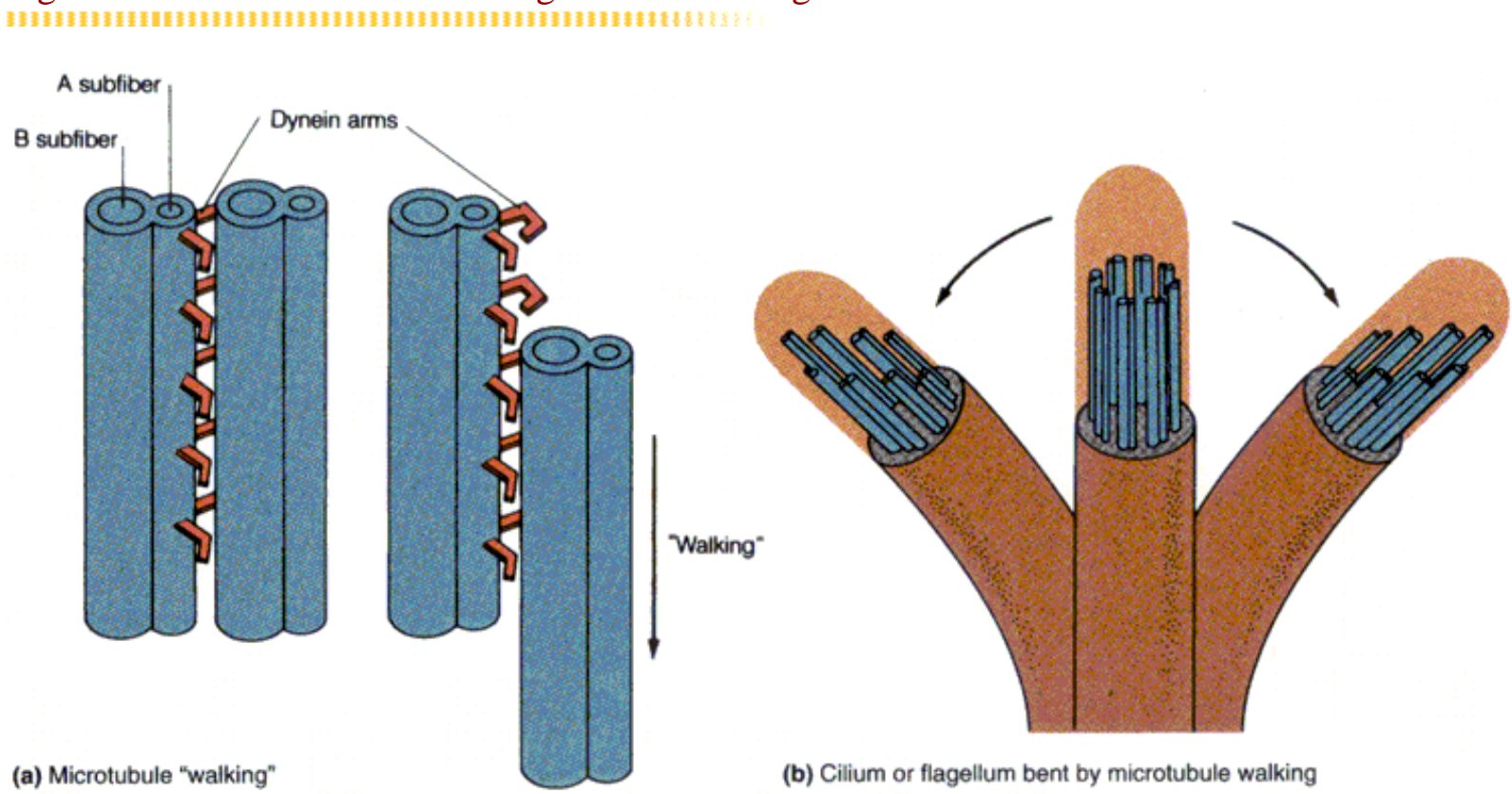

Figure 8.22b: Ultrastructure of a cilium.



(b)

Figure 8.24: Model for the bending of cilia and flagella.



Programmed Destruction of Proteins

Overview - Regulatory proteins such as cyclins (see [here](#)), which are essential in certain parts of the cell cycle and deleterious in others, must be eliminated at some point. Proteins that have become damaged must also be removed.

Methods of protein degradation - Eukaryotic cells have the following two distinct methods for protein degradation:

1. **Lysosomal system** - The primary **lysosomes**, budded from the Golgi complex, are bags of degradative enzymes. Over 50 different hydrolytic enzymes are contained in **lysosomes**, including proteases, nucleases, lipases, and carbohydrate-cleaving enzymes. The **lysosomes** play a number of important roles in cellular metabolism, as schematically depicted in [Figure 28.42](#). In some cells, primary **lysosomes** migrate to the cell surface and release their contents into the exterior medium (path A, [Figure 28.42](#)). If primary **lysosomes** fuse with autophagic vesicles (formed when smooth [endoplasmic reticulum](#) engulfs organelles destined for destruction) (path B, [Figure 28.42](#)), the combined vesicle is called an autophagic **lysosome**. When primary **lysosomes** fuse with phagocytic vacuoles that have engulfed nutrient materials at the cell surface (path C, [Figure 28.42](#)), heterophagic **lysosomes** are created in which nutrients are digested and their [amino acids](#), [nucleotides](#), lipids, and other constituents are released into the cytosol.

2. **Cytosolic Degradation System** - Protease activity in the cytosol must be under rigid control, attacking only the proteins whose destruction is needed. Because general proteases would hydrolyze virtually all cytoplasmic proteins, cells must have a way to distinguish proteins to be attacked from those to be left alone.

Ubiquitin marking - The best-known cytoplasmic protein targeting system uses a protein called ubiquitin, a 76-residue polypeptide, found in virtually every eukaryotic cell. Marking and degradation proceeds as follows:

1. **Ubiquitin's** carboxyl group is activated by thiol coupling to an activating enzyme ([Figure 28.43](#)) in an ATP-dependent process.
2. The **ubiquitin** moieties are then transferred to a second enzyme ([Figure 28.43](#), step 2).
3. The second enzyme attaches **ubiquitin** to ϵ -amino groups of [lysine](#) residues on the fated protein ([Figure 28.43](#), step 3).

4. Some **ubiquitinated** proteins are simply marked for translocation to specific cellular sites, and others are marked for reasons yet unknown, but most are marked for proteolytic digestion in particles called proteasomes.

Proteasomes - Both 20S and 26S **proteasomes** are known. [Figure 28.44](#) shows the structure of the yeast 20S **proteasome**. Structurally, the **proteasome** shows remarkable similarity to the GroEL chaperonin (see [here](#)). Both are multitiered cylinders with 7-fold symmetry. Both can accept an unfolded polypeptide chain in their hollow interior. But whereas GroEL protects the polypeptide chain, the **proteasome** degrades it.

See also: [Cathepsins](#), [Calpains](#), [Protein Turnover](#) (from Chapter 20), [S-Adenosylmethionine and Biological Methylation](#), [Covalent Modification of Proteins](#)

INTERNET LINK: [The Proteasomes](#)

Figure 28.42: Formation of primary and secondary lysosomes and their role in cellular digestive processes.

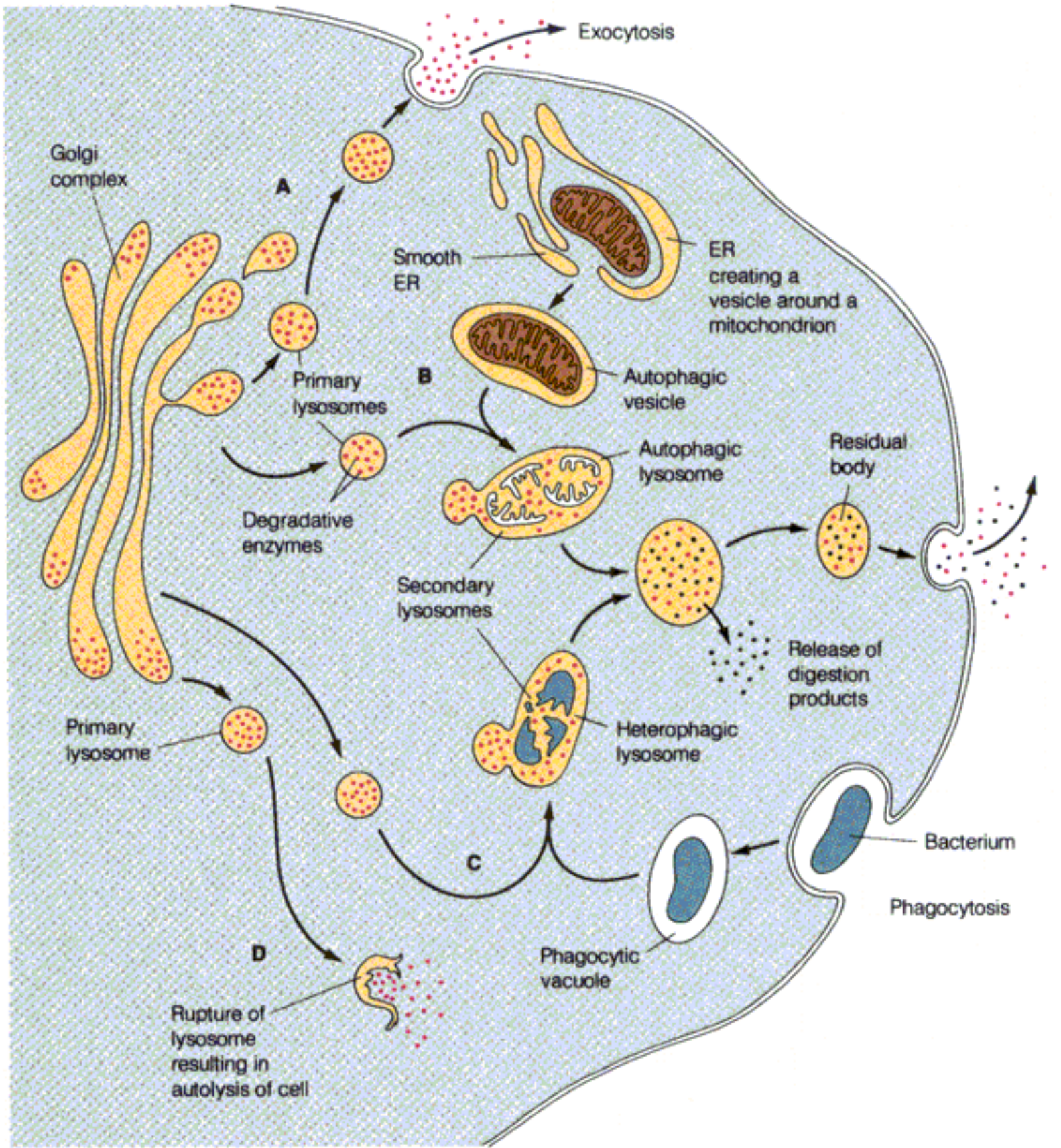

Derivatives of Monosaccharides

Monosaccharides can be chemically altered in several ways to provide new classes of compounds. These include:

Phosphorylated derivatives - made by esterifying a phosphate group to one of the hydroxyls. Several examples are shown in [Table 9.3](#). Numerous other examples exist. Phosphorylated sugars have standard state free energies of hydrolysis less negative than that of [ATP](#), but sufficiently negative to act in some cases as "activated compounds" in metabolic reactions. The acid phosphate group gives these molecules a negative charge at neutral pH (see also [here](#)).

Acids and Lactones - made by mild oxidation of an aldose, for example, to form an aldonic acid (see [here](#)). Free aldonic acids are in equilibrium with lactones (see [here](#)). In metabolic pathways, oxidation at carbon 6 of glucose yields glucuronic acid.

Alditols - made by reducing the carbonyl group of a sugar. The resulting polyhydroxy compounds are called alditols. Important ones include [erythritol](#), [D-mannitol](#), and [D-glucitol](#) (also called sorbitol).

Amino Sugars - made by replacing a hydroxyl of a sugar with an amine group. Two common examples are [β-D-glucosamine](#) and [β-D-galactosamine](#). Common molecules derived from these include [β-D-N-acetylglucosamine](#), [muramic acid](#), [N-acetylmuramic acid](#), [β-D-N-acetylgalactosamine](#), and [N-acetylneuraminic acid](#) (also called sialic acid). Amino sugars are often found in oligosaccharides and polysaccharides.

Glycosides - formed by elimination of water between the anomeric hydroxyl of a cyclic monosaccharide and the hydroxyl group of another compound. Glycosides do not undergo mutarotation in the absence of an acid catalyst, so they remain locked in the α or β configuration. Many glycosides are known. Some, such as [ouabain](#) or [amygdalin](#) ([Figure 9.15](#)) are very poisonous.

See also: [Sugar Ring Structures](#), [Monosaccharide Nomenclature](#), [Glycosides and Glycosidic Bonds](#), [Biosynthesis of Amino Sugars](#) (from Chapter 16)

Table 9.3

Name	Structure	$\Delta G^{or\ddagger}$ (kJ/mol)	pK_{a1}	pK_{a2}
D-Glyceraldehyde-3-phosphate		~ -12	2.10	6.75
β -D-Glucose-1-phosphate		-20.9	1.10	6.13
β -D-Glucose-6-phosphate		-13.8	0.94	6.11
α -D-Fructose-6-phosphate		-13.8	0.97	6.11

[†]Free energy of hydrolysis at pH 7.0 and 37°C

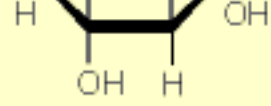

Free energy of hydrolysis at pH 7.0 and 37°C.

Unnumbered Item

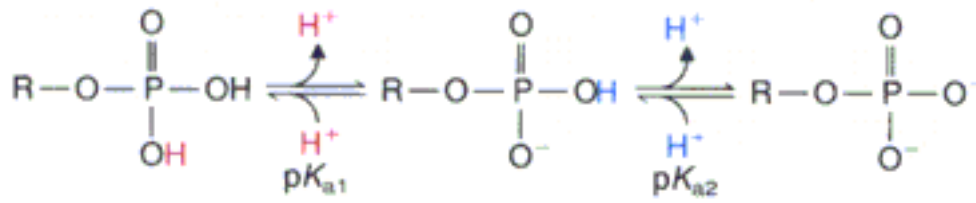

Unnumbered Item

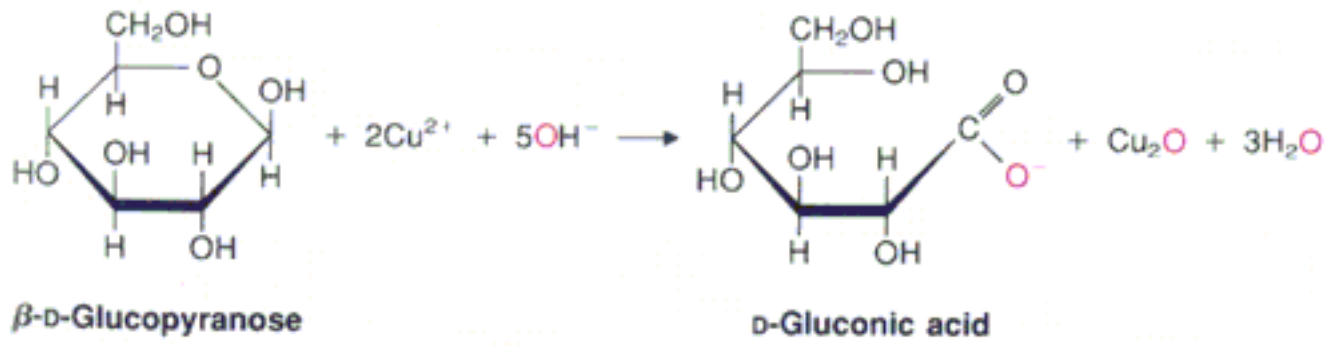

Unnumbered Item

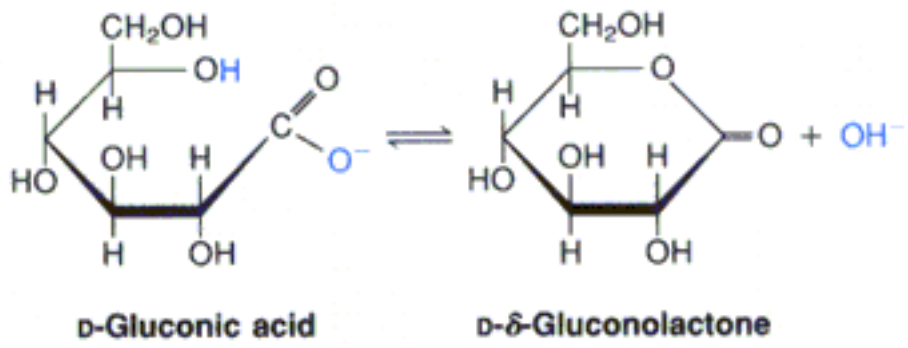

Erythritol

Like [mannitol](#) and [sorbitol](#), **erythritol** (see [here](#) also) is an alditol - a molecule created by reducing the carbonyl group of the corresponding sugar (in this case, [erythrose](#)).

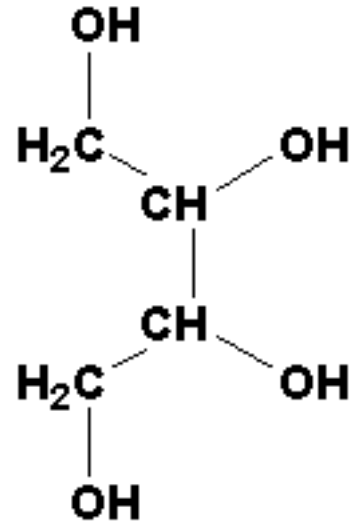

Erythritol

Note that **erythritol** appears to contain chiral carbons, but actually doesn't because it has a plane of symmetry between carbons 2 and 3. It is therefore not optically active.

See also: [Derivatives of Monosaccharides](#)

Mannitol

Mannitol is an alditol - a molecule made by reducing the carbonyl group of a sugar to a hydroxyl. The sugar from which **mannitol** is made is [mannose](#) (see [here](#) also).

See also: [Derivatives of Monosaccharides](#)

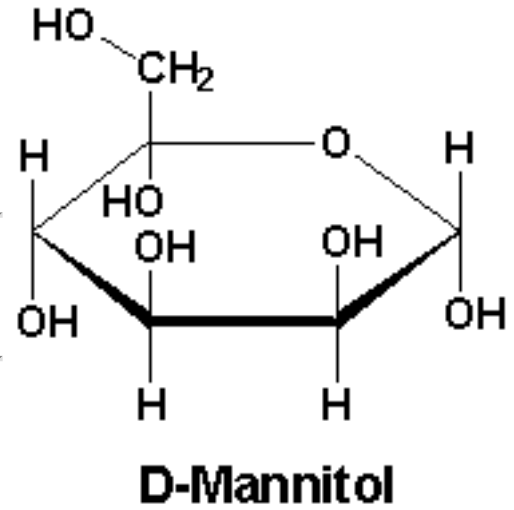

Unnumbered Item

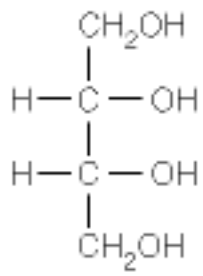

Erythritol*

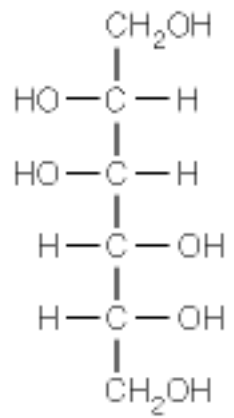

D-Mannitol

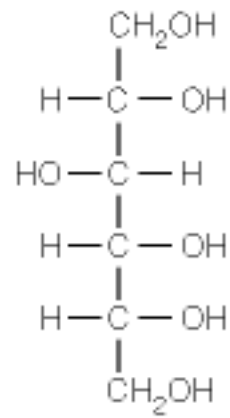

**D-Glucitol
(sorbitol)**

Sorbitol

Sorbitol (also known as glucitol) is an alditol - a molecule made by reducing the carbonyl group of a sugar to a hydroxyl. **Glucose** is the sugar from which **sorbitol** is made (see [here](#) also).

See also: [Derivatives of Monosaccharides](#),

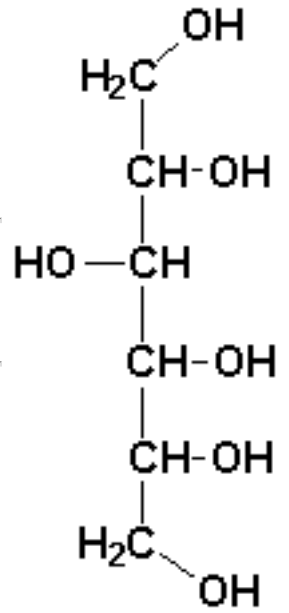

Sorbitol

D-Glucosamine

D-Glucosamine is a simple amine sugar made by replacing the hydroxyl at position two of **glucose** with an amine group.

See also: [Derivatives of Monosaccharides](#), [Biosynthesis of Amino Sugars](#)

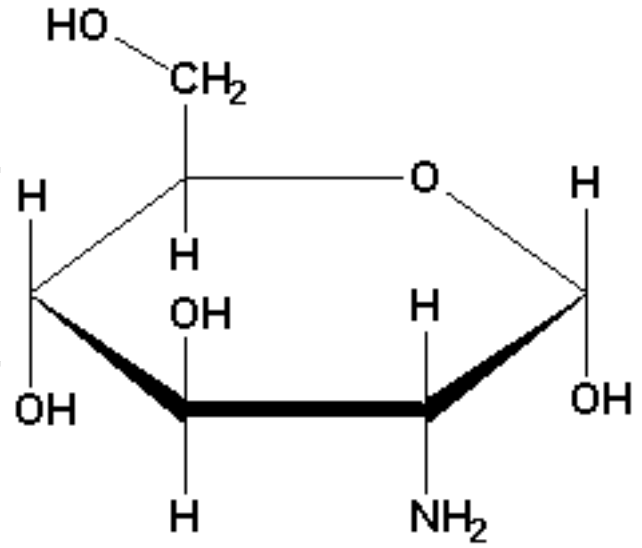

D-Glucosamine

Biosynthesis of Amino Sugars

Amino sugars are essential for making glycoconjugates - macromolecules containing covalently bound oligosaccharide chains. Glycoconjugates include glycoproteins and glycolipids.

General - **Glucose** is a metabolic precursor for all sugars not in the diet. The glycolysis intermediate, fructose-6-phosphate (**F6P**) is the precursor of the amino sugars. The nitrogen comes from the amide group of glutamine in the following reaction, which is catalyzed by **glutamine:fructose-6-phosphate amidotransferase**, is as follows:



In this reaction, oxidation of carbon 1 is coupled to reduction of carbon 2. Next, glucosamine-6-phosphate is converted to UDP-N-acetylglucosamine, in the three steps shown in **Figure 16.13**.

Sialic Acid - **Figure 16.14** depicts the synthesis of N-acetylneuraminic acid (sialic acid) from UDP-N-acetylglucosamine. Sialic acid is an important constituent of glycoproteins. Activated sialic acid is made by linking, not to a nucleoside diphosphate (as in other sugar derivative activations), but to a nucleoside monophosphate, CMP, in the following reaction:



N-acetyl- β -lactosamine - The reaction is catalyzed by **galactosyltransferase** as follows:



In lactating females, the mammary gland protein, α **lactalbumin** (which is activated hormonally in mothers shortly after birth) binds to galactosyltransferase and changes its specificity so that it catalyzes the synthesis of lactose (the major sugar of milk), as follows:



See also: **Biosynthesis of Glycoconjugates**

Glutamine: Fructose-6-Phosphate Amidotransferase



Glutamine: Fructose-6-Phosphate Amidotransferase catalyzes the reaction that follows:



This is first step in synthesis of amino sugars. In subsequent steps, the glucosamine-6-phosphate is converted to UDP-N-acetylglucosamine ([Figure 16.13](#))

See also: [Biosynthesis of Amino Sugars](#), [Biosynthesis of Glycoconjugates](#)

Glucosamine-6-Phosphate

Glucosamine-6-phosphate is an important metabolic precursor of all the amino sugars. It is synthesized from **glutamine** and **fructose-6-phosphate** in a reaction catalyzed by **glutamine:fructose-6-phosphate amidotransferase**. **Glucosamine-6-phosphate** is subsequently converted to **UDP-N-acetylglucosamine**, as shown in **Figure 16.13**.

Glucosamine-6-phosphate is an allosteric inhibitor of **glutamine synthetase**, an enzyme central to nitrogen metabolism in the cell.

See also: [Biosynthesis of Amino Sugars](#)

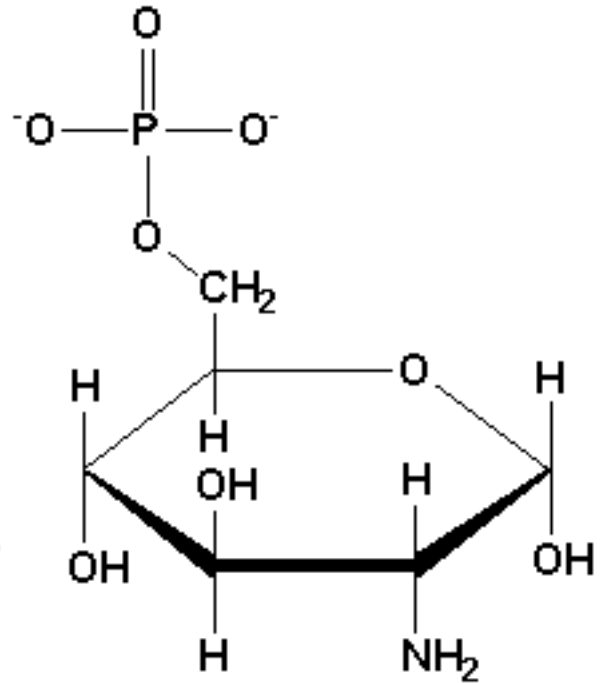

Glucosamine-6-phosphate

UDP-N-Acetylglucosamine

UDP-N-acetylglucosamine is a nucleotide derivative of N-acetylglucosamine made ultimately from glucosamine-6-phosphate (Figure 16.13).

UDP-N-acetylglucosamine is an intermediate in chitin biosynthesis in insects, participates in synthesis of hyaluronic acid, and is involved in the first step of synthesis of N-linked glycoproteins. In the latter process,

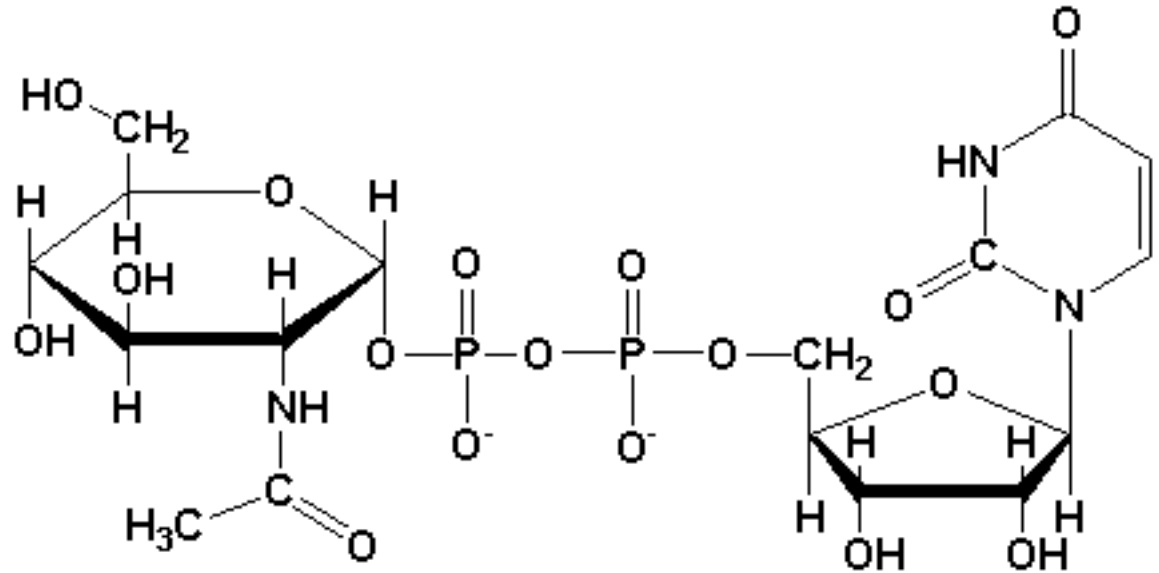

UDP-N-acetylgalactosamine

UDP-N-acetylglucosamine, transfers the N-acetylglucosamine moiety to dolichol phosphate (Figure 16.17). The antibiotic tunicamycin acts by blocking this transfer and inhibiting synthesis of N-linked glycoproteins.

UDP-N-acetylglucosamine is a precursor of UDP-N-acetylmuramic acid in biosynthesis of UDP-N-acetylmuramylpentapeptide for bacteria cell walls.

See also: Biosynthesis of Glycoconjugates, Chitin, Glucosamine-6-Phosphate, Bacterial Cell Walls

Figure 16.13: Pathway for biosynthesis of UDP-N-acetylglucosamine from glucosamine-6-phosphate.

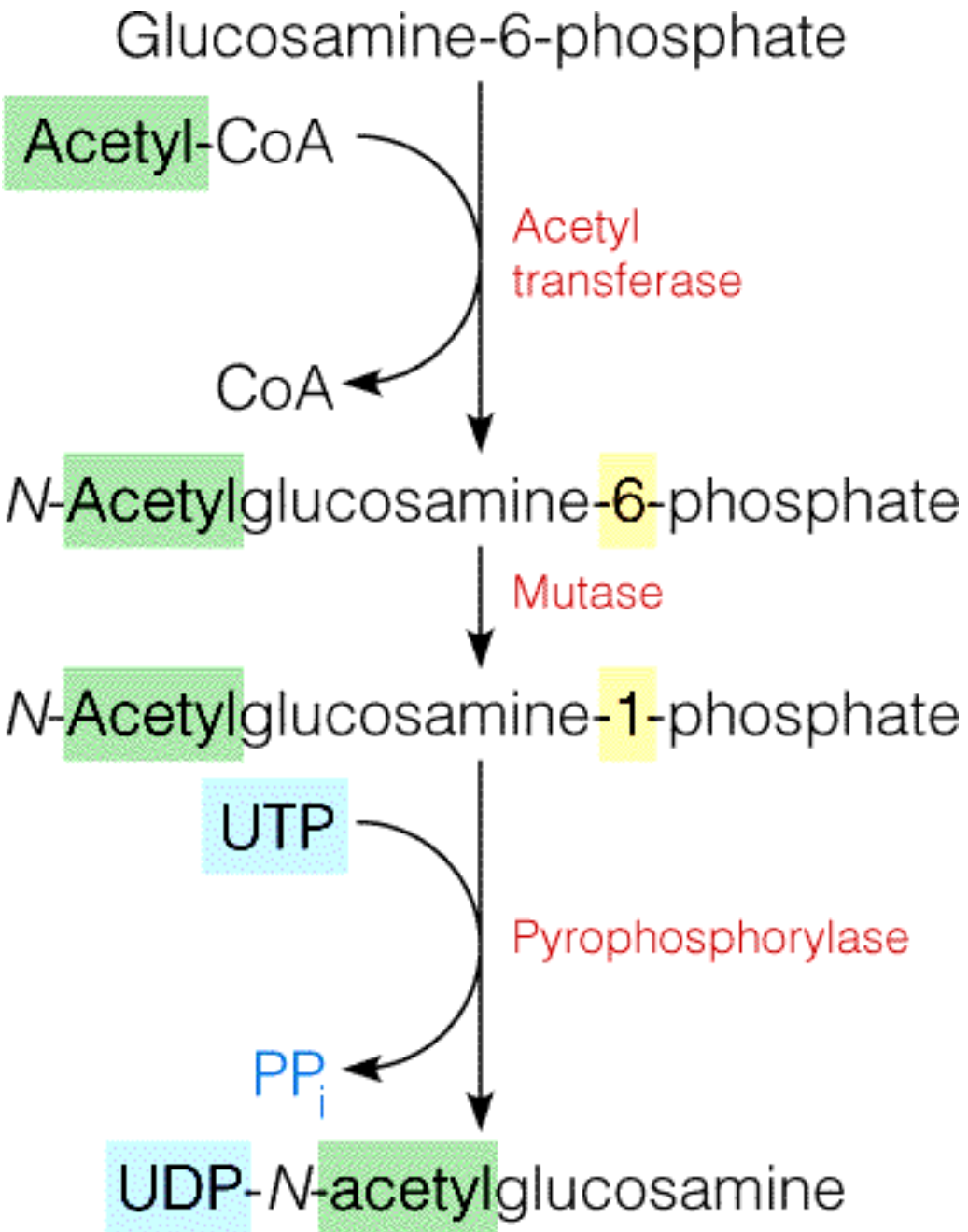

Hyaluronic Acid

Hyaluronic acid is a heteropolymer of alternating units of **glucuronic acid** and **N-acetylglucosamine**. The repeating unit of the polymer is shown at the right.

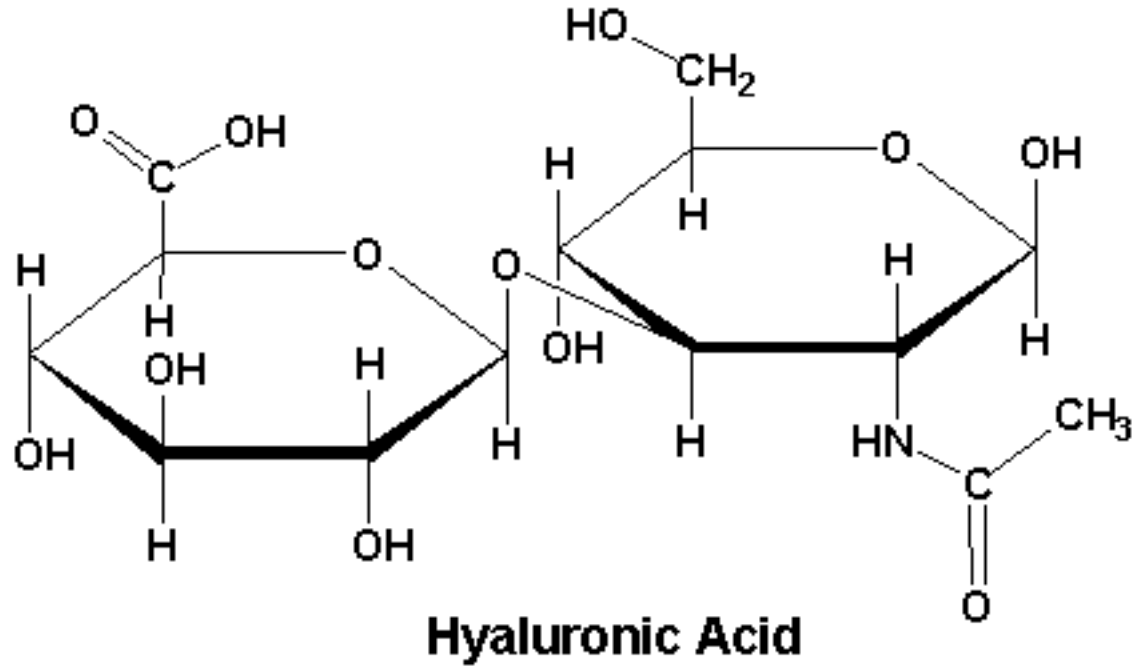

See also: [Chondroitin Sulfates](#), [Keratan Sulfates](#), [Dermatan Sulfates](#), [Figure 9.23](#)

N-Acetyl-D-Galactosamine Sulfate



N-Acetyl-D-galactosamine sulfate is a component of the class of polymers known as the chondroitin sulfates.

See also: Figure 9.23

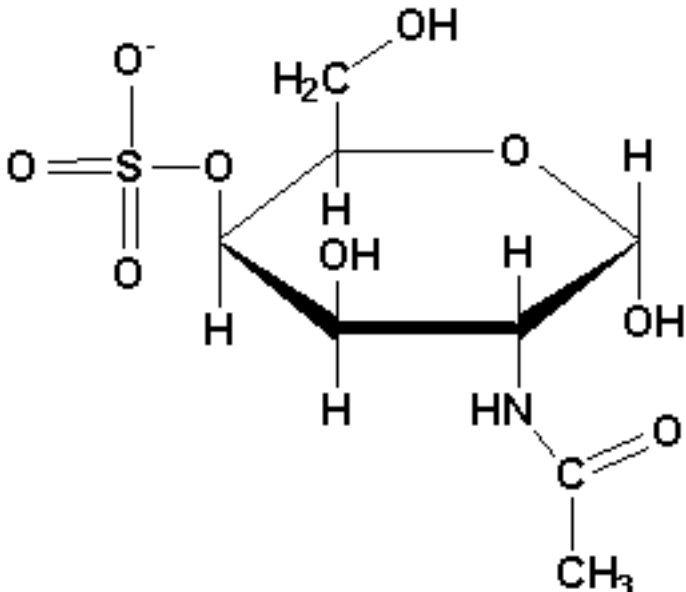

N-Acetyl-D-galactosamine-sulfate

Figure 9.24b: Proteoglycan structure in bovine cartilage.

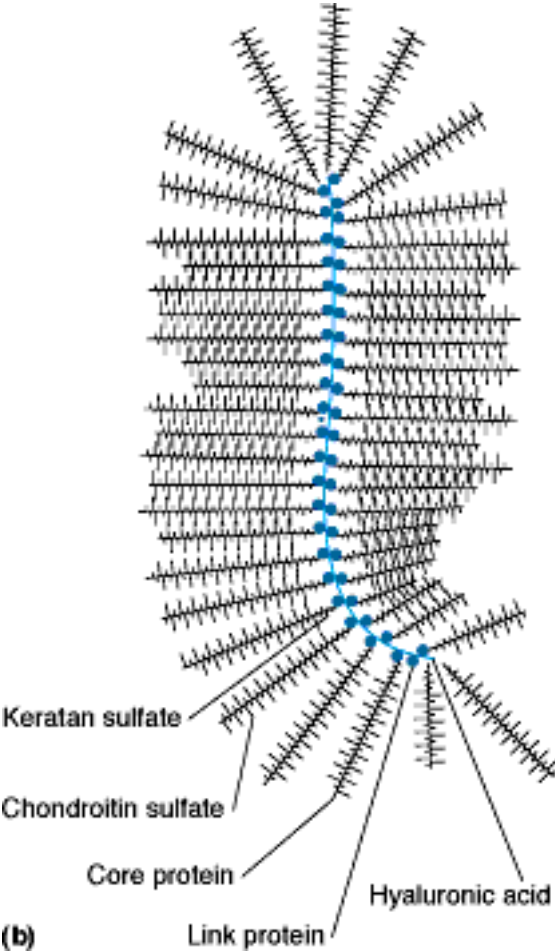

Dermatan Sulfates



Dermatan sulfates are a class of structural [glycosaminoglycans](#) of skin.

See also: [Polysaccharides](#), [Chondroitin Sulfates](#), [Keratan Sulfates](#)

Keratan Sulfates



Keratan sulfates ([Figure 9.23](#)) are a class of structural [glycosaminoglycans](#) found in connective tissue of vertebrates.

See also: [Polysaccharides](#), [Chondroitin Sulfates](#), [Dermatan Sulfates](#)

Dolichol Phosphate

Dolichol phosphate is an isoprenoid compound (90-100 carbons total) made from **dolichol** (see [here](#) for synthesis of dolichol via the cholesterol biosynthetic route) by phosphorylation catalyzed by a kinase that uses **CTP** as the energy and phosphate source. **Dolichol phosphate** performs two important functions in synthesis of N-linked glycoproteins.

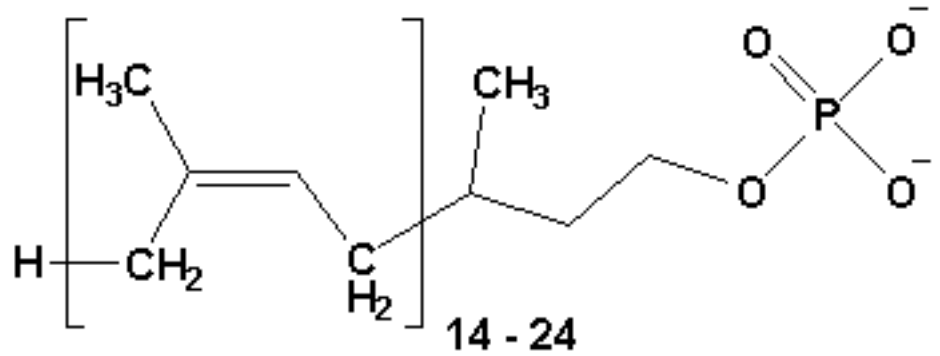

Dolichol Phosphate

- Dolichol phosphate** is the structure upon which the complex oligosaccharide is made before transfer to the target protein. (The addition of the first moiety, **N-acetylglucosamine** from **UDP-N-acetylglucosamine**, can be blocked by the antibiotic, **tunicamycin**.) After assembly of the oligosaccharide is complete, the carbohydrate structure is transferred from **dolichol phosphate** to an **asparagine** residue of a target protein having the sequence Asn-x-Ser/Thr, where X is any amino acid.
- Dolichol phosphate** is a carrier of sugars to oligosaccharide chain synthesis assembly. Such activated sugars include **dolichol-P-mannose** and **dolichol-P-glucose**.

See also: [Biosynthesis of Glycoconjugates](#), [Figure 16.16](#), [Figure 16.17](#)

Dolichol

Dolichol is an isoprenoid compound synthesized by the same metabolic route as cholesterol (see [here](#)). In vertebrate tissues, **dolichol** contains 18-20 isoprenoid units (90-100 carbons total).

Dolichol is phosphorylated by a kinase that uses CTP to form **dolichol Phosphate**. **Dolichol phosphate** is the structure upon which the carbohydrate moieties of N-linked glycoproteins are built. After assembly on **dolichol phosphate**, the carbohydrate structure is transferred to an

asparagine residue of a target protein having the sequence Asn-x-Ser/Thr, where X is any amino acid.

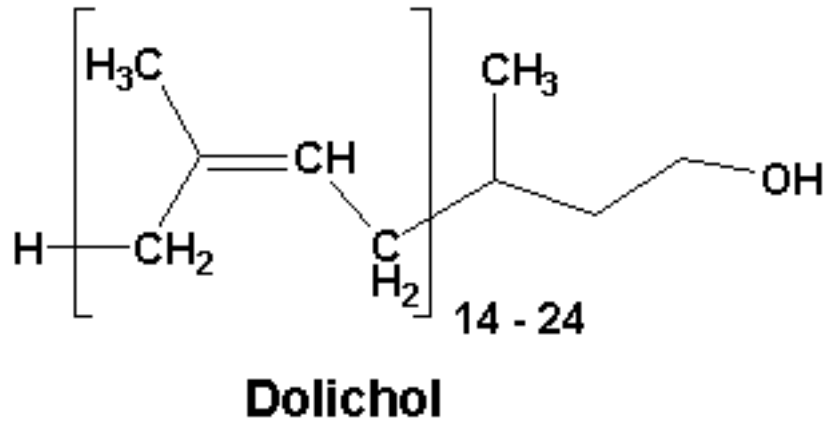

See also: [Biosynthesis of Glycoconjugates](#), [Figure 16.16](#), [Figure 16.17](#)

Biosynthesis of Glycoconjugates

Covalent binding of carbohydrate to protein or lipid brings about large changes in the physical properties of these substances that allow them to serve specialized biochemical functions. Sulfated polysaccharides in **glycoproteins**, for example, are effective biological lubricants and linking carbohydrates to lipids allows them to be inserted into membranes.

Mammalian **glycoproteins** are classified as O-linked or N-linked. N-linked **glycoproteins** contain an **N-acetylglucosamine** residue linked to the amide nitrogen of an **asparagine** residue in the protein (see [here](#)). The most common O-linkage involves a terminal **N-acetylgalactosamine** residue in the oligosaccharide linked to a **serine** or **threonine** residue of the protein (see [here](#)).

O-Linkage - A synthesis pathway for O-linked **glycoproteins** is shown in [Figure 16.15](#). Note that oligosaccharide assembly occurs on the polypeptide chain. The A, B, and O blood group substances on erythrocyte surfaces are the best-known O-linked **glycoproteins**. Note that both the A and B antigens are made by building onto the O substance backbone. The AB blood type arises from individuals who are heterozygous for A and B antigens. They have both enzymes and carry both antigens in their blood.

N-Linkage - Oligosaccharide assembly occurs not on the polypeptide chain, but on a lipid-linked intermediate. A precursor oligosaccharide is then transferred to a polypeptide chain, which is itself still in the midst of being synthesized. Finally, the transferred oligosaccharide is subject to further processing as it passes from the rough and smooth **endoplasmic reticulum** through the Golgi complex. [Figure 16.16](#) lists the three common structures found on asparagine-linked (N-linked) oligosaccharides. All of the known N-linked oligosaccharides have a common core pentasaccharide structure (boxed in [Figure 16.16](#)). The core pentasaccharide is assembled as part of a larger oligosaccharide intermediate linked to the isoprenoid lipid compound, dolichol phosphate.

[Figure 16.17](#) illustrates biosynthesis of the dolichol-phosphate-linked oligosaccharide intermediate. A short summary is as follows:

The entire process occurs in the endoplasmic reticulum (ER).

The first seven sugars are transferred to dolichol phosphate from nucleoside diphosphate sugars, **UDP-N-acetylglucosamine** and **GDP-mannose**. Each reaction is catalyzed by a separate glycosyltransferase. The antibiotic, **tunicamycin**, inhibits synthesis of all N-linked glycoproteins by inhibiting the first enzyme in the process.

The next seven reactions utilize dolichol-linked sugars as substrates. These are **dol-P-mannose** and **dol-P-glucose**, which are, in turn, synthesized from dol-P plus GDP-

mannose and **UDP-glucose**, respectively. During this stage, the lipid-linked intermediate (the third intermediate in **Figure 16.17**) is translocated from the exterior surface of the ER-membrane to the luminal, or interior side.

The oligosaccharide unit is transferred to a polypeptide acceptor in a reaction catalyzed by a specific oligosaccharyltransferase. The acceptor site is an asparagine residue in the sequence Asn-X-Ser/Thr, where X is any amino acid. The acceptor site must be accessible in a loop or a bend in the polypeptide chain.

Processing of the oligosaccharide-linked polypeptides begins in the lumen of the rough endoplasmic reticulum and continues as the nascent glycoprotein moves into the smooth ER and ultimately through the Golgi apparatus. In virtually all cases, processing begins with removal of the three glycosyl residues in the rough ER, followed by removal of some of the mannosyl residues in the Golgi apparatus. Complex glycoproteins are further processed by addition of N-acetylglucosamine, followed by further trimming of mannosyl residues. **Fucose**, **galactose**, and **Sialic acid** residues are added from appropriate nucleotide-linked sugars by specific glycosyl-transferases.

Oligosaccharide chains help direct **glycoproteins** to appropriate intracellular destinations.

See also: **Biosynthesis of Amino Sugars**, **Oligosaccharides and Polysaccharides as Cell Markers** (from Chapter 9), **Dolichol Phosphate**

Unnumbered Item

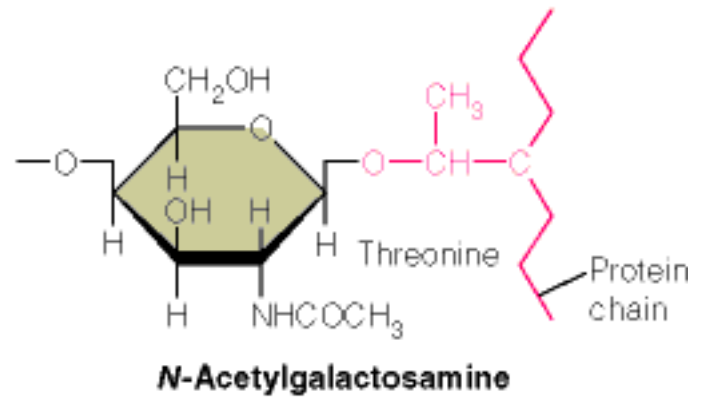
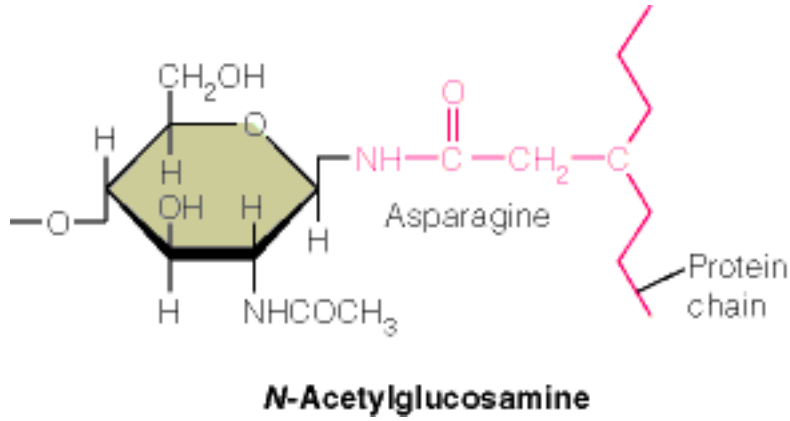

Figure 9.29: The ABO blood group antigens.

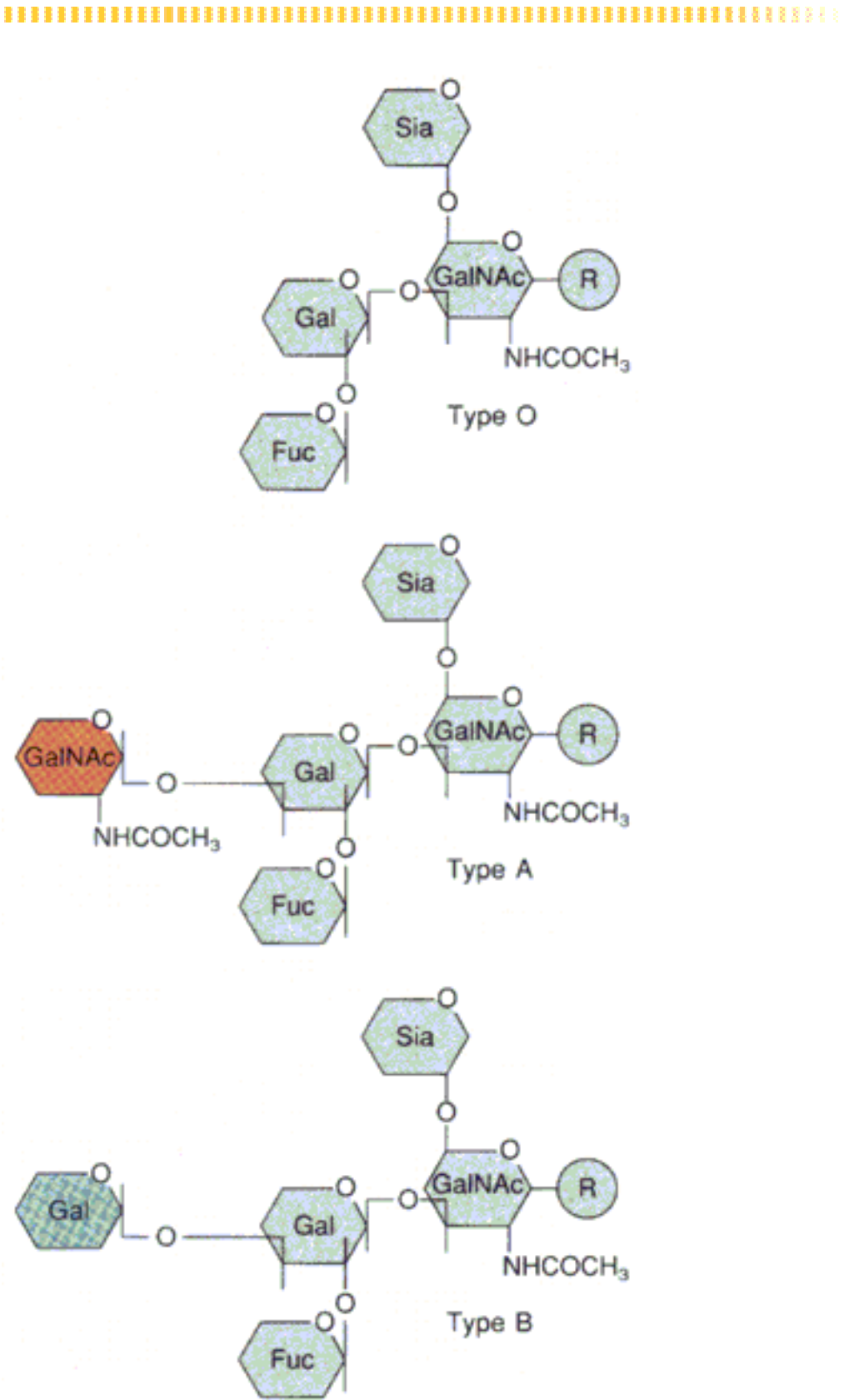
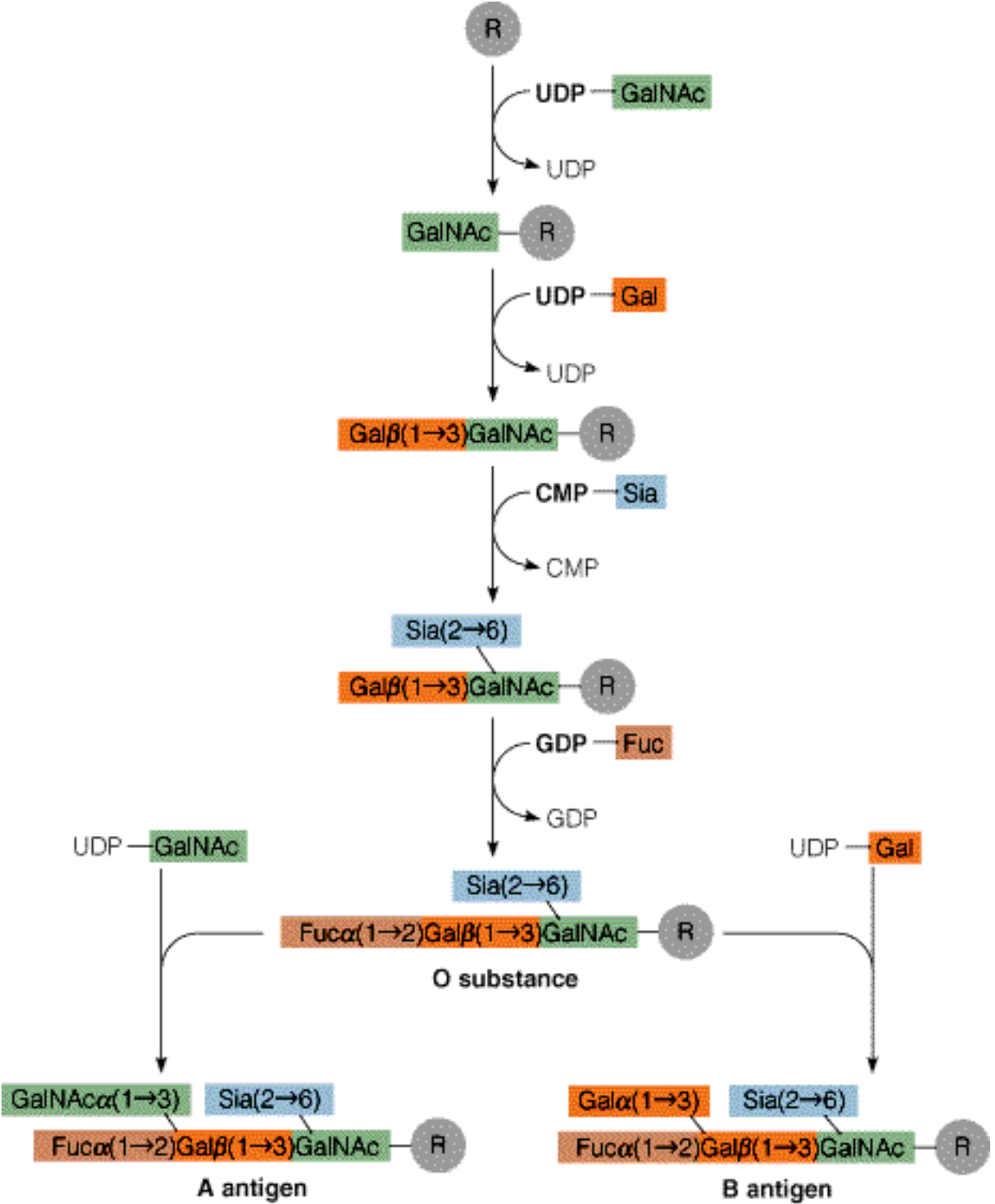

Figure 16.15: Biosynthesis of O-linked oligosaccharide units on glycoproteins of the O, A, and B blood group substances.



Tunicamycin

Tunicamycin is an antibiotic that blocks the reaction of **UDP-GlcNAc** and **Dol-P** in the first step of glycoprotein synthesis, thus inhibiting the synthesis of all N-linked glycoproteins (**Figure 16.17**).

See also: [Biosynthesis of Glycoconjugates](#)

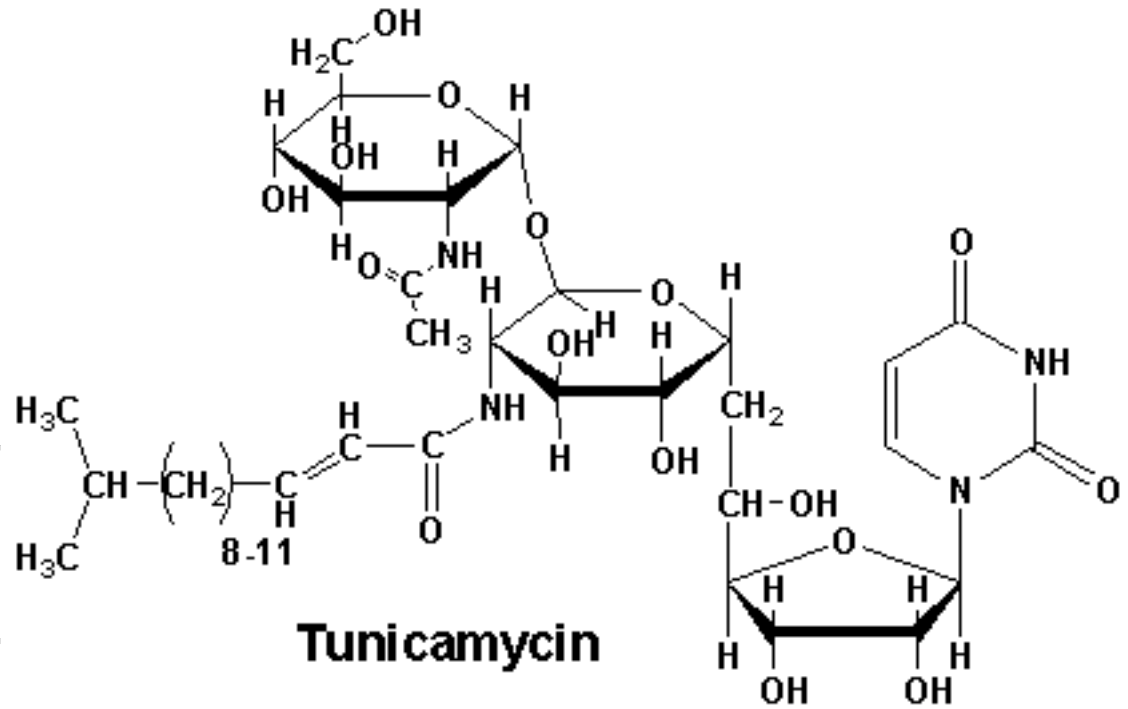

UDP-N-Acetylmuramic Acid

UDP-N-acetylmuramic acid is made from [UDP-N-acetylglucosamine](#) (see [Figure](#)) on the pathway to synthesis of [UDP-N-acetylmuramyl pentapeptide](#) for bacteria cell walls ([Figure 16.19](#), [Figure 16.20](#)).

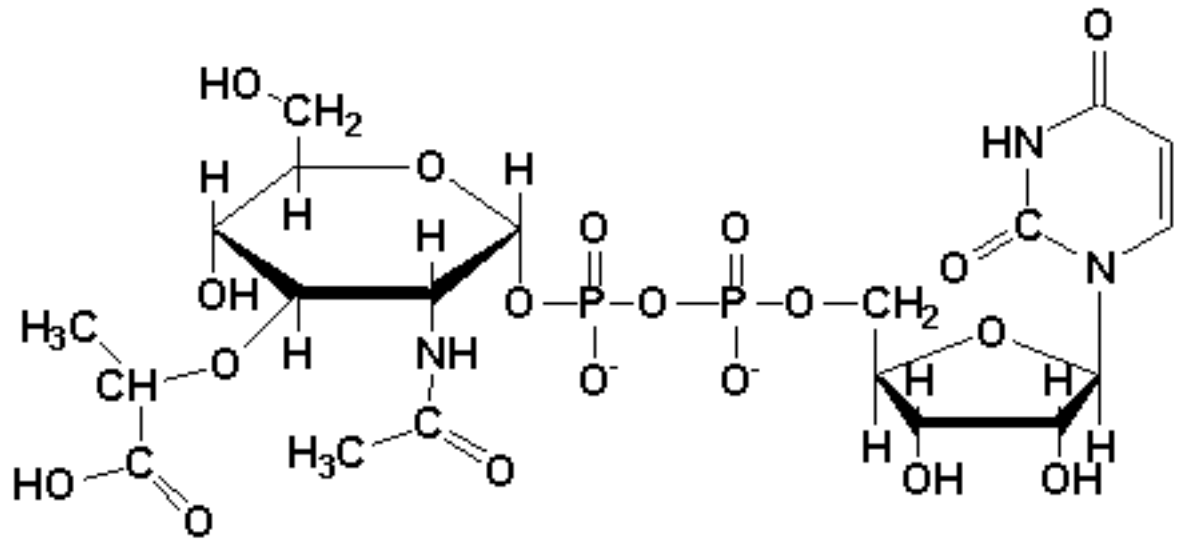

UDP-N-acetylmuramic acid

See also: [Bacterial Cell Wall Biosynthesis](#),

Unnumbered Item

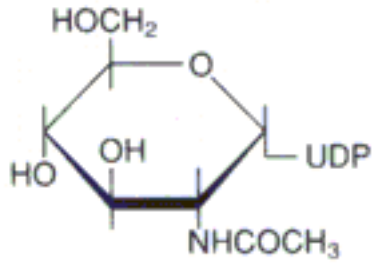

UDP-*N*-acetylglucosamine

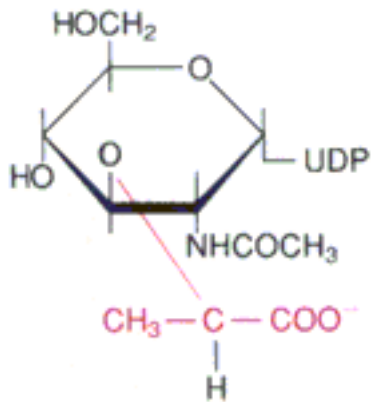
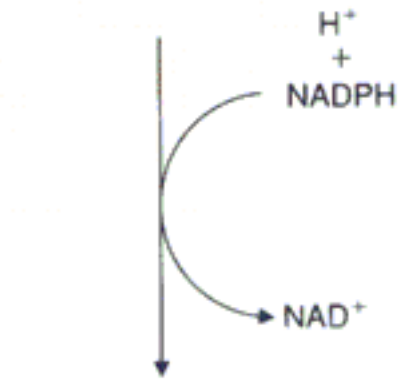
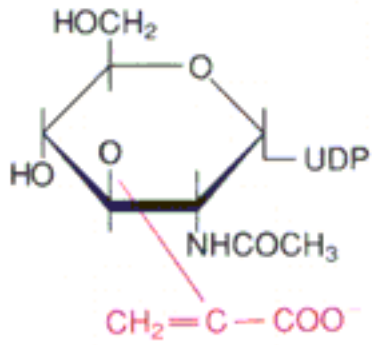
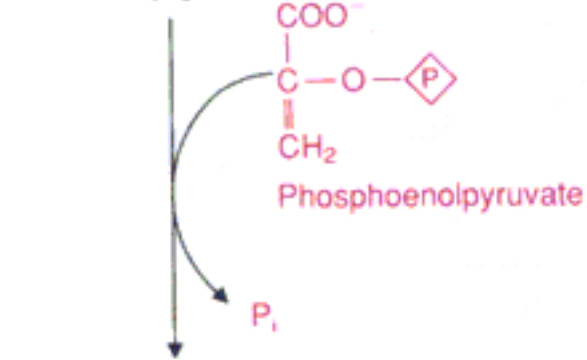

UDP-*N*-acetylmuramic acid

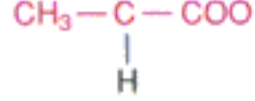

UDP-*N*-acetylmuramic acid

UDP-N-Acetylmuramylpentapeptide



UDP-N-acetylmuramyl pentapeptide is derived from UDP-N-acetylmuramic acid by the sequential addition of the following groups, L-alanine, D-glutamate, L-Lysine, D-Dlanine, D-Alanine (Figure 16.19, Figure 16.20)

See also: Bacterial Cell Wall Biosynthesis

Figure 16.19: Biosynthesis of UDP-N-acetylmuramylpentapeptide from UDP-N-acetylmuramic acid.

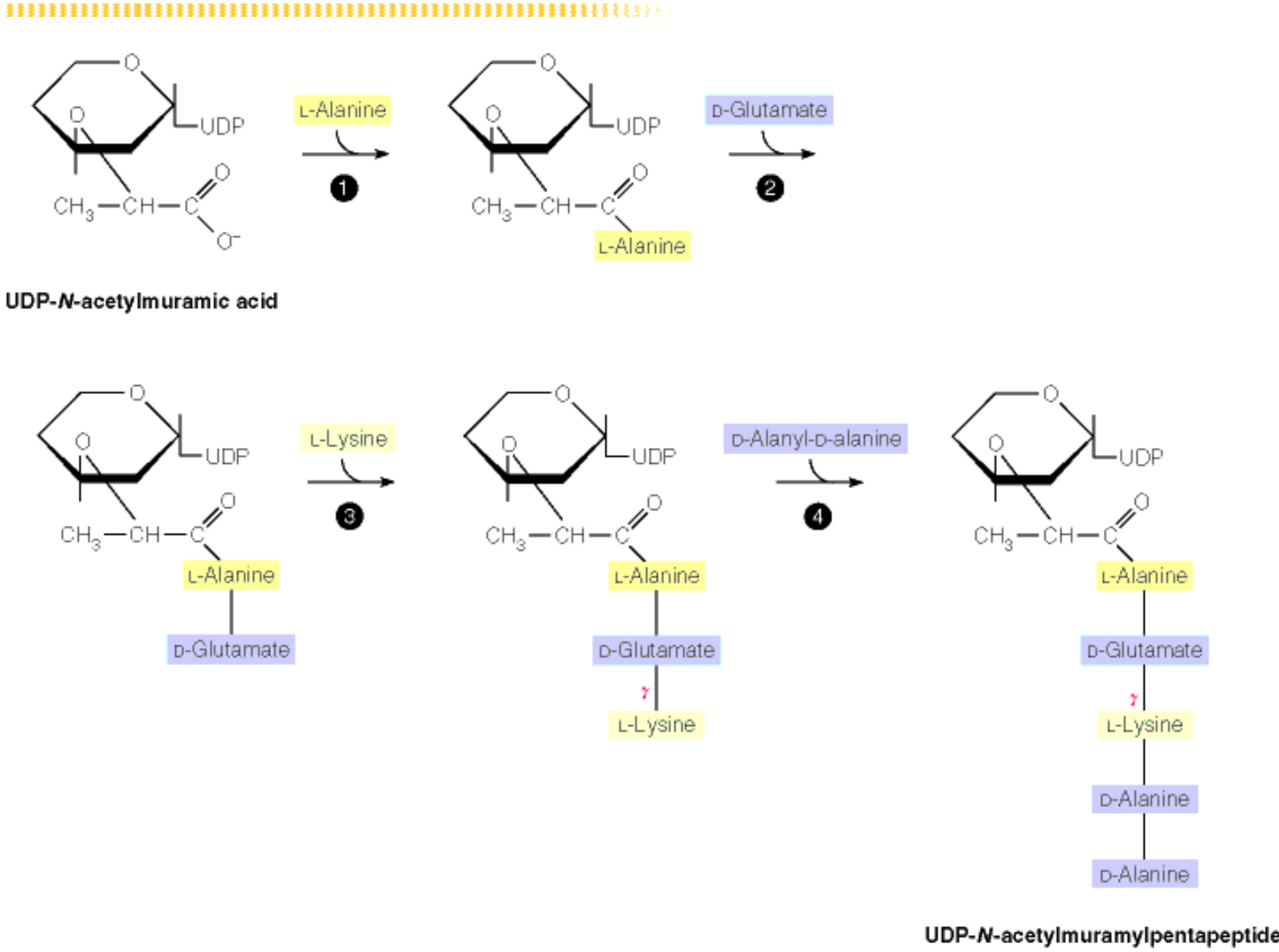
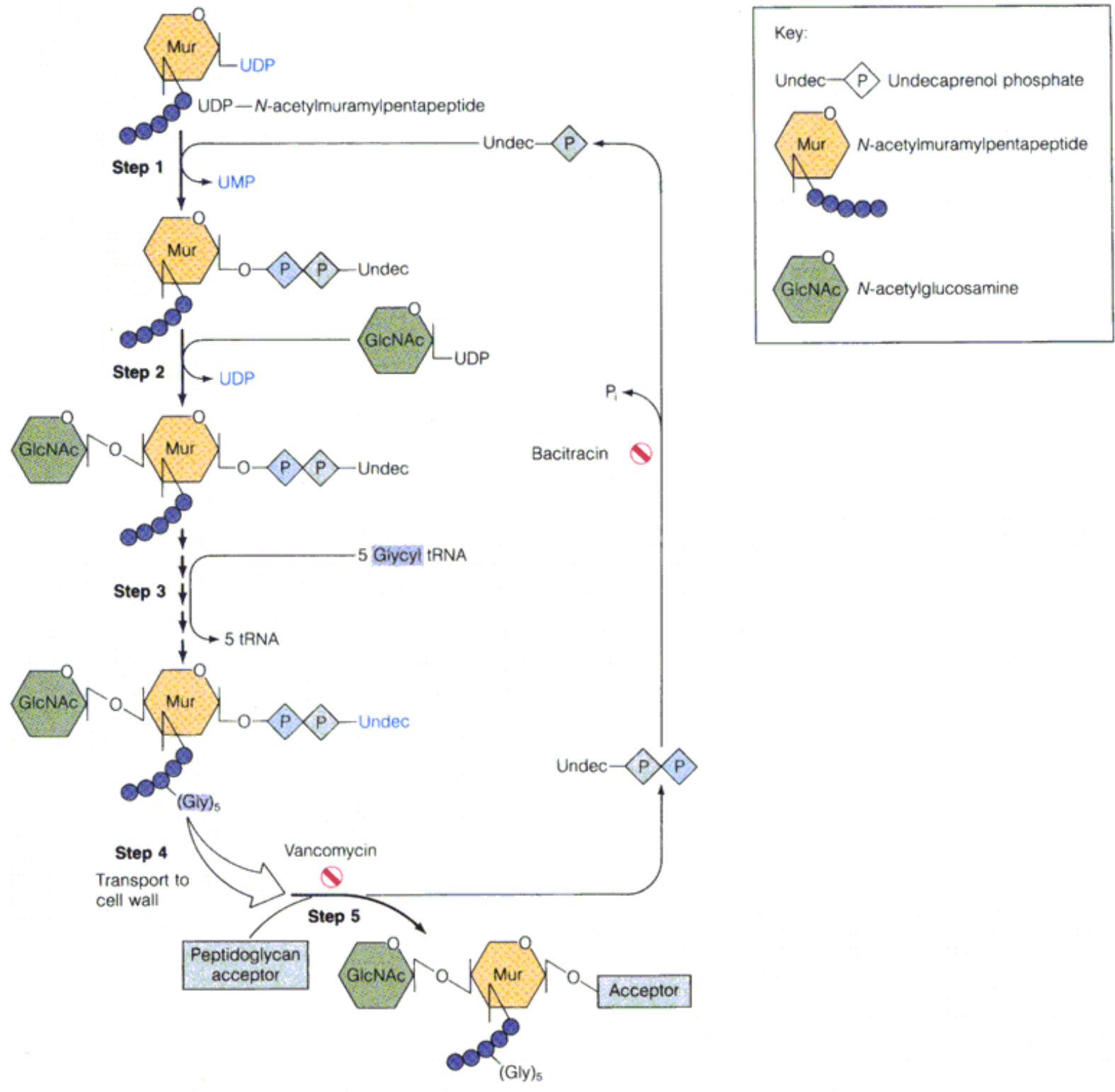

Figure 16.20: Synthesis of the linear peptidoglycan molecule of *Staphylococcus aureus*.



Microbial Cell-Wall Polysaccharides - Peptidoglycans

Gram-positive bacteria contain a rigid **peptidoglycan** cell wall surrounding the cytoplasmic membrane. Gram-negative bacteria contain an additional third, outer layer. This wall is a complex structure with lipoproteins and lipopolysaccharides. Synthesis of two outer walls from different bacterial cells is described in this concept screen:

Staphylococcus aureus - The polysaccharide chain is an alternating polymer of **N-acetylglucosamine** and **N-acetylmuramic acid**. The carboxyl groups of all the N-acetylmuramic acid residues are linked to the terminal group of the tetrapeptide-L-alanyl-D-γ-isoglutaminyl-L-lysyl-D-alanine. The biosynthesis can be considered to occur in the following three distinct stages:

1. Synthesis of **UDP-N-acetylmuramyl pentapeptide** - This reaction sequence begins with the synthesis of **UDP-N-acetylmuramic acid** from **UDP-N-acetylglucosamine** (see [here](#)). **Figure 16.19** shows subsequent steps in which the pentapeptide is built onto the UDP-N-acetylmuramic acid carboxyl group. Note that these peptide bonds are made by specific ATP-dependent ligases, not **ribosomes**.
2. Polymerization of N-acetylglucosamine and N-acetylmuramylpentapeptide - This process involves the lipid carrier, **undecaprenol phosphate**, a 55-carbon compound containing 11 isoprenoid units, with phosphate linked at the terminus. To this phosphate, the N-acetylmuramylpentapeptide moiety from stage 1 is attached (**Figure 16.20, step 1**). Next, N-acetylglucosamine is added from UDP-N-acetylglucosamine (**Figure 16.20, step 2**), followed by the sequential addition of five glycy residues, from glycy transfer RNA (**Figure 16.20, step 3**). Next, the peptidodisaccharide unit is transported through the membrane (**Figure 16.20, step 4**). Last, the molecule is added to the reducing end of a preexisting peptidoglycan chain (**Figure 16.20, step 5**). The antibiotics **bacitracin** and **vancomycin** inhibit specific steps in this process, as shown in **Figure 16.20**.
3. Cross-linking of individual peptidoglycan strands - This transpeptidation reaction uses energy from cleavage of one peptide bond to form another. This process is shown in **Figure 16.21**. The cross-linking reaction is the target of action for the penicillins and the cephalosporins. **Penicillin** is thought to react irreversibly with the transpeptidase that catalyzes the cross-linking. Unfortunately, resistance to penicillin can be acquired by bacteria that synthesize lactamase, an enzyme that hydrolyzes the lactam ring of penicillin and destroys its ability to interfere with peptidoglycan synthesis.

Salmonella typhimurium - This organism's O antigen is the major lipopolysaccharide component of the outer membrane. Lipopolysaccharides contain repeating oligosaccharide units attached to a basal core

polysaccharide. The latter is, in turn, attached to a complex called lipid A. The repeating oligosaccharide units provoke strong immune reactions. To avoid the immune response, bacteria change the O-antigen structure through extremely rapid genetic change. The mechanism for its synthesis is depicted in [Figure 16.22](#).

See also: [Biosynthesis of Glycoconjugates](#), [N-Acetylglucosamine](#), [N-Acetylmuramic Acid](#), [Bacterial Cell Walls](#)

Peptidoglycans

Peptidoglycans are components of the coat of bacterial cell walls. [Figure 9.27](#) shows the structure of a peptidoglycan from Gram-positive bacteria. In Gram-positive bacteria, the cell wall is multi-layered, due to cross-links between the individual layers of **peptidoglycans**. Lipoteichoic acid projects through the lipid bilayer and intermeshes with the **peptidoglycan** layer. Gram-negative bacteria have only a single layer of **peptidoglycans** on their outer cell wall. The peptide part of the **peptidoglycan** has two unusual amino acids, D-alanine and D-isoglutamic acid. Cross-links between the peptides are formed by pentaglycine chains between the ϵ -amino group of the lysine on one chain and the C-terminal carboxyl group of the alanine on an adjacent chain.

Peptidoglycan synthesis in bacteria is a target of several antibiotics, such as penicillin, which block bacterial growth by interfering with formation of the **peptidoglycan** layer. Lysozyme is an enzyme that acts as a natural antibiotic. It catalyzes the hydrolysis of the glycosidic links between [N-acetylglucosamine](#) and the [N-acetylmuramic acid](#) residues of the **peptidoglycan**.

See also: [Bacterial Cell Walls](#), [Bacterial Cell Wall Biosynthesis](#), [Figure 16.20](#)

Figure 9.27: The structure of a lipoteichoic acid.

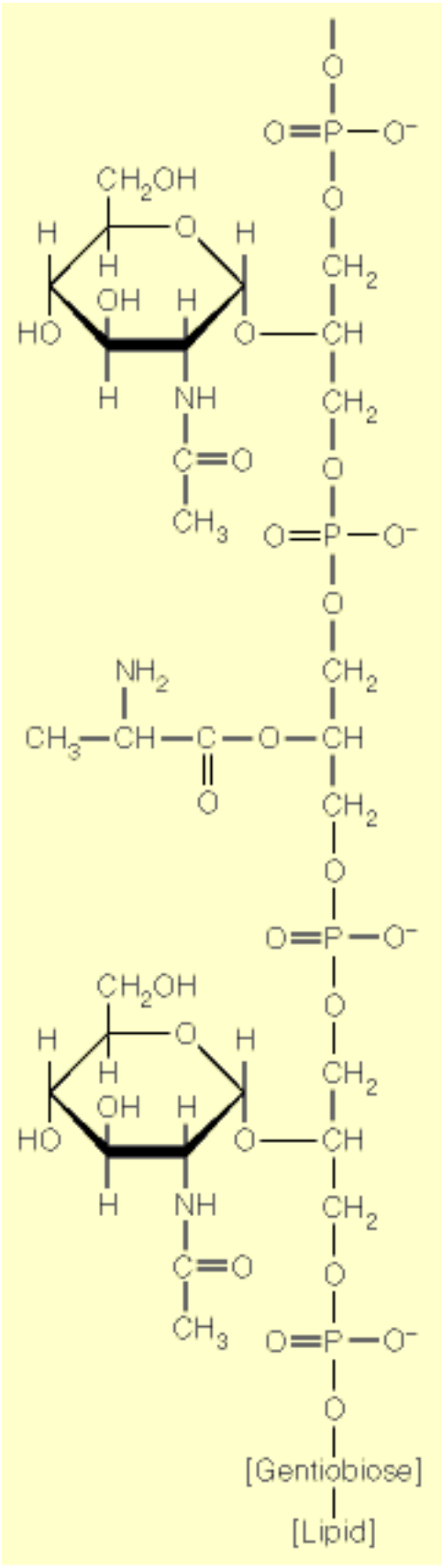

N-Acetylmuramic Acid

N-Acetylmuramic acid (MURNAc) is part of the **peptidoglycan** polymer of Gram-positive bacterial cell walls. **MURNAc** is covalently linked to **N-acetylglucosamine** and may also be linked through the hydroxyl on carbon number 4 to the β carbon of **L-alanine** (**Figure 9.26**). A pentapeptide composed of L-alanyl-D- γ -isoglutamyl-L-lysyl-D-alanine-D-alanine is added to the **MURNAc** in the process of making the peptidoglycan strands of the cell wall.

See also: [Muramic Acid](#), [Bacterial Cell Walls](#)

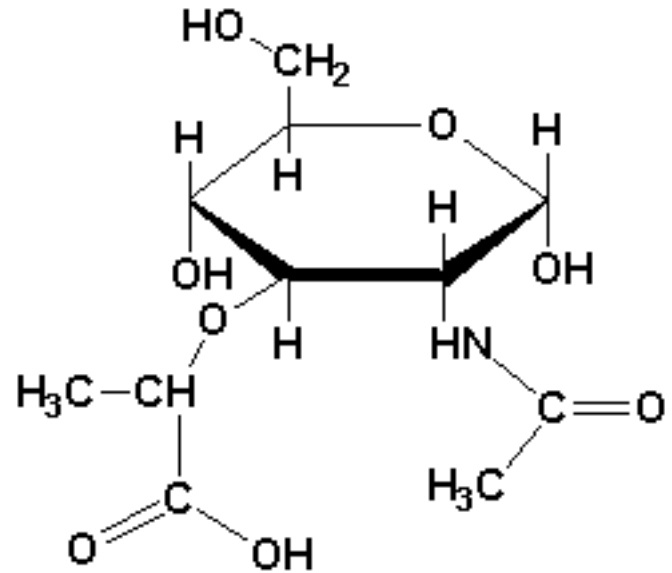

N-Acetylmuramic acid

Muramic Acid

Muramic acid is a modified monosaccharide found in glycoproteins and peptidoglycans. An acetylated form of muramic acid, N-Acetylmuramic Acid, is a component of the polysaccharide in the cell wall of Gram positive bacteria (see here).

See also: Derivatives of Monosaccharides

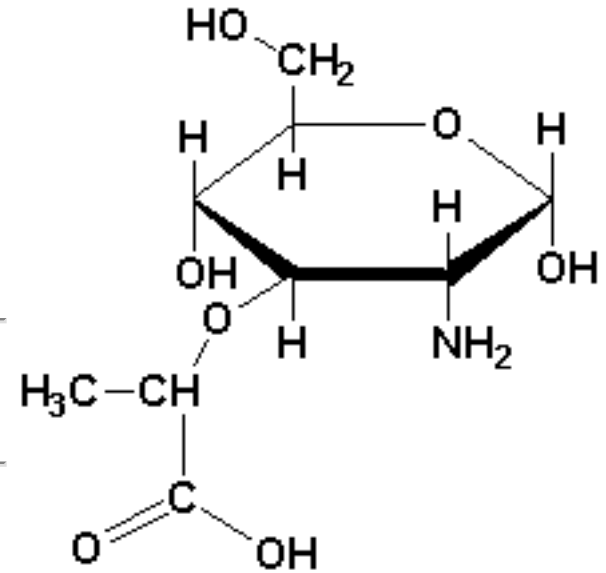

Muramic Acid

Bacterial Cell Walls

The different structures of the **cell walls** of **Gram-positive** and **Gram-negative bacteria** provide the means of distinguishing them. **Gram-positive bacteria** retain a dye-iodine complex, but it can be washed from **Gram-negative bacteria**. The difference arises because the **cell walls** in **Gram-positive bacteria** consist of a cross-linked multilayered polysaccharide-peptide complex called peptidoglycan, layered on top of a lipid bilayer membrane, whereas the **cell walls** in **Gram-negative bacteria** consist of a single layer of peptidoglycan sandwiched between outer and inner lipid bilayer membranes ([Figure 9.25](#)).

In **Gram-positive bacteria**, the long polysaccharide chains are strictly alternating copolymers of N-acetylglucosamine (NAG) and N-acetylmuramic acid (NAM). An unusual tetrapeptide, (L-ALA)-(D-GLU)-(L-LYS)-(D-ALA), is attached to the lactic acid moiety of the NAM ([Figure 9.26](#)). The presence of the **D-amino acids** and the unusual linkage of the **glutamic acid** through its γ -carboxyl group may help protect the peptide against protease action. Individual peptides are cross-linked together with a **glycine** pentapeptide joining adjacent lysines through the ϵ amino group ([Figure 9.26](#)).

In addition, lipid-oligosaccharide complexes called lipoteichoic acids protrude from the membrane through the peptidoglycan wall. ([Figure 9.26](#)).

See also: [Structural Polysaccharides](#), [Polysaccharides](#), [N-Acetylglucosamine](#), [N-Acetylmuramic Acid \(NAM\)](#), [Bacterial Cell Wall Biosynthesis](#) (from Chapter 16), [Figure 16.20](#)

Figure 9.25: Bacterial cell walls.

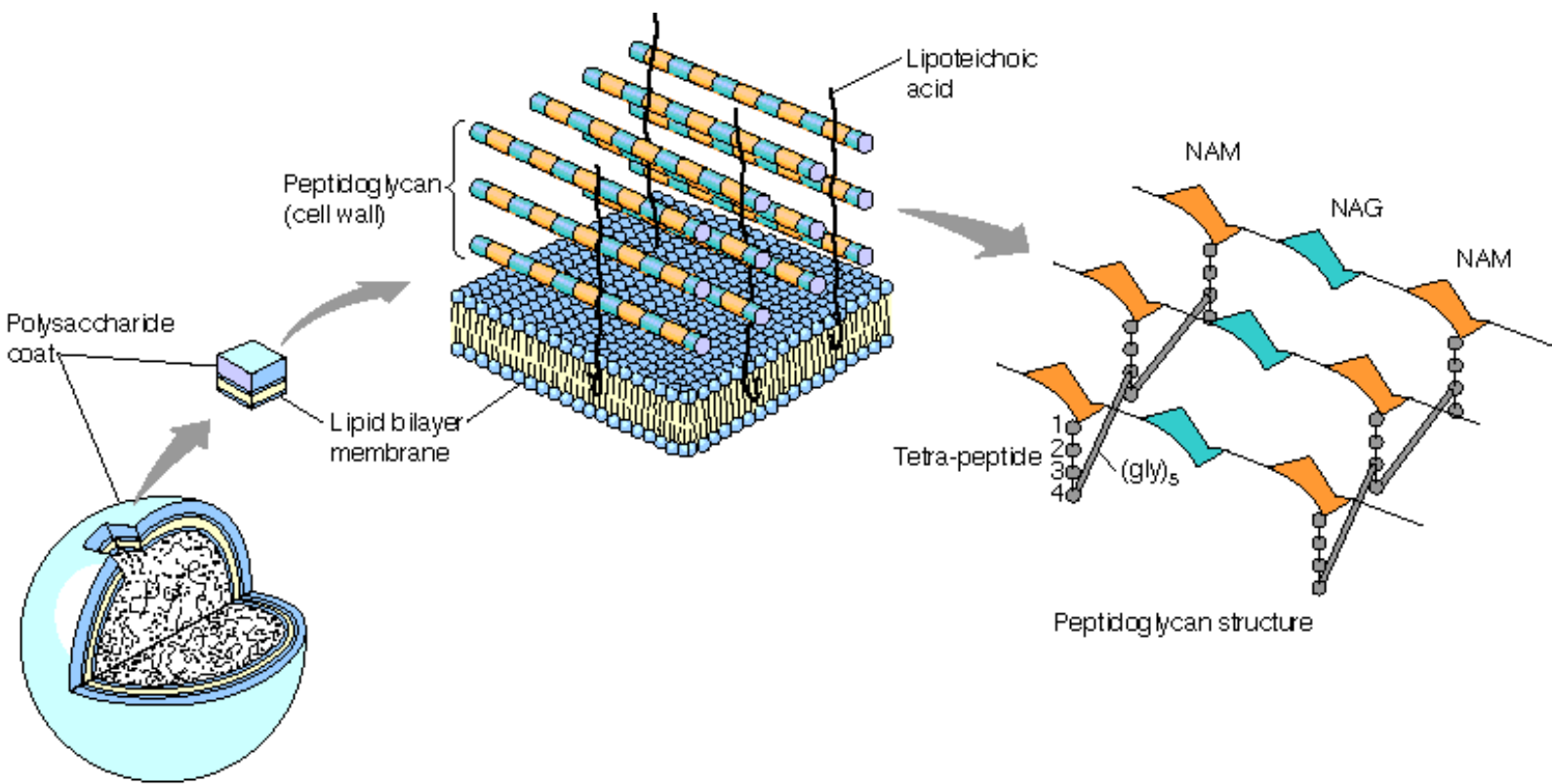

(a) Gram positive: *Staphylococcus aureus*

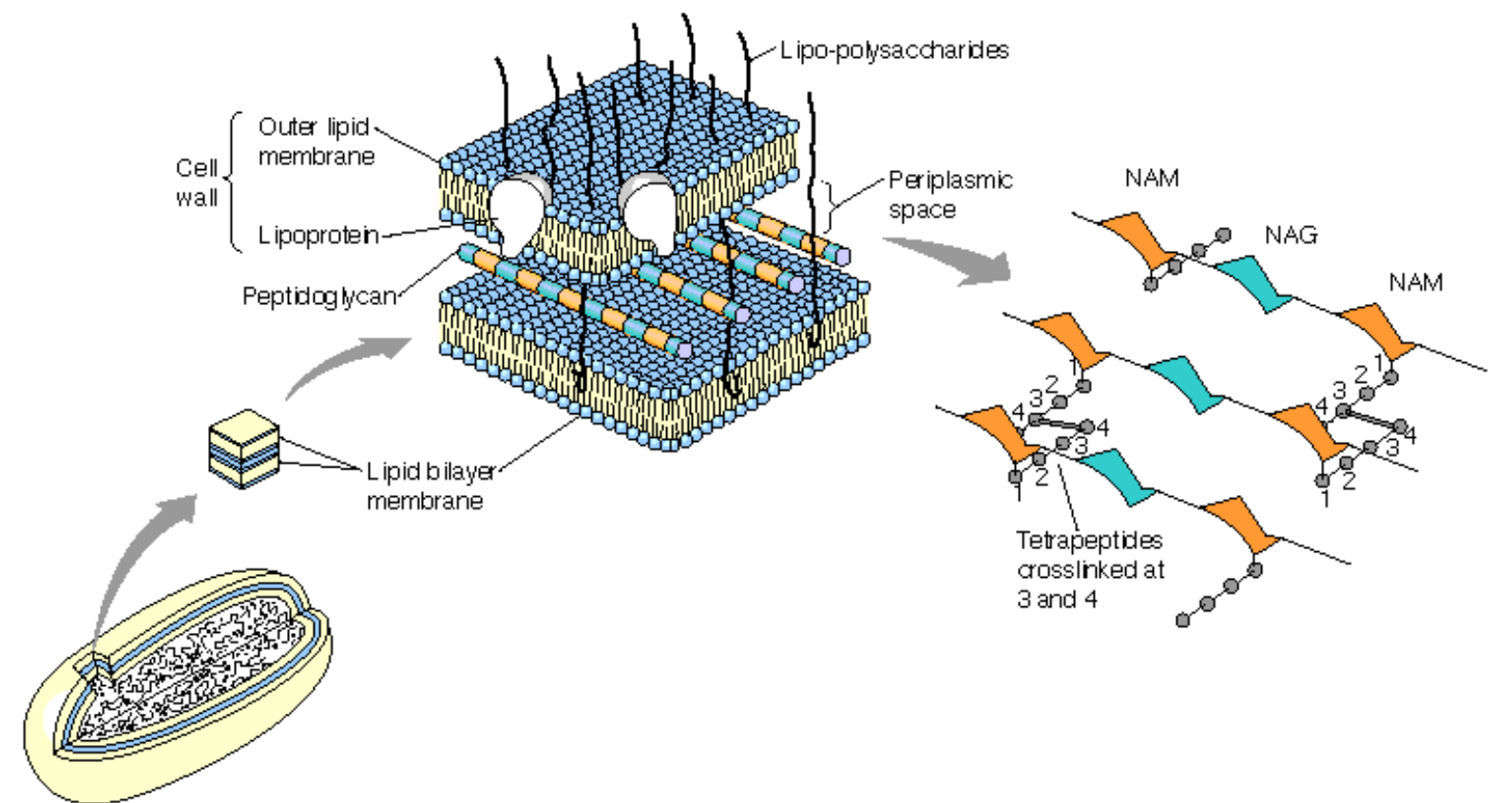

(b) Gram negative: *Escherichia coli*

Structural Polysaccharides

A major function of **polysaccharides** in organisms is providing **structural integrity**. This is quite important in plants, because they do not use fibrous proteins, such as keratin (see [here](#)) or collagen, for this purpose.

Cellulose is a glucan (contains only **glucose**) and is the major polysaccharide in woody and fibrous plants. It is the most abundant single polymer in the biosphere. Made up of units of D-glucose linked in the β 1- \rightarrow 4 configuration, cellulose forms a planar structure with individual parallel chains held together by hydrogen bonds ([Figure 9.21](#)). Most animals cannot digest the β 1- \rightarrow 4 linkages in cellulose. Among the animals, only ruminants (cows, horses, etc.) contain a symbiotic bacterium with an enzyme, **cellulase**, that can break cellulose down to glucose. Fungi too contain cellulases. Cellulose is also used as a structural component of some animal cells, such as the marine invertebrates called tunicates.

Other glucans with structural roles include some in fungi, which have glucoses joined by β 1- \rightarrow 3 or β 1- \rightarrow 6 bonds.

Other plant polysaccharides include the xylans and the glucomannans (see [here](#)). The xylans are polymers of **D-xylopyranose**, often with substituent groups attached. The glucomannans, on the other hand, are heteropolymers of **glucopyranose** and **mannopyranose** joined by β 1- \rightarrow 4 linkages with β 1- \rightarrow 6 branches to other substituents. The glucomannans and xylans are often grouped together and called hemicellulose.

Chitin is a homopolymer of **N-acetyl-D-glucosamine**, with units joined by β 1- \rightarrow 4 bonds. Chitin is found in organisms as diverse as algae, fungi, insects, arthropods, mollusks, and insects.

Glycosaminoglycans are heteropolysaccharides containing either **N-acetylgalactosamine** or **N-acetylglucosamine** as one of their monomeric units. Examples include **chondroitin sulfates** and **keratan sulfates** of connective tissue, **dermatan sulfates** of skin, and **hyaluronic acid**. All of these are acidic, through the presence of either sulfate or carboxylate groups (See [Figure 9.23](#)). A major function of glycosaminoglycans is formation of a matrix to hold together the protein components of skin and connective tissue in animals. An example is the proteoglycan complex (protein-carbohydrate complex) in cartilage ([Figure 9.24b](#)). This structure binds **collagen**, apparently via electrostatic interactions between the sulfate and/or carboxylate groups of the proteoglycan complex and the basic side chains in collagen.

See also: [Saccharides](#), [Oligosaccharides](#), [Polysaccharides](#), [Monosaccharide Nomenclature](#)

Fibrous Proteins

The two major classes of proteins are the **fibrous proteins** and the **globular proteins**. **Fibrous proteins** are distinguished from globular proteins by their filamentous, elongated form. Most of them play structural roles in animal cells and tissues, holding things together. **Fibrous proteins** have amino acid sequences that favor a particular kind of secondary structure which, in turn, confer particular mechanical properties on the proteins.

Table 6.2 lists the amino acid compositions of four different fibrous proteins, namely α -keratin, fibroin, collagen, and elastin. Notice the relatively high abundance of amino acids with non-bulky side chains, such as **glycine**, **alanine**, **serine**, **glutamate**, and **glutamine**. A notable exception to this is the quite high amount of proline in collagen and, to a lesser extent, in elastin. Each of the proteins in **Table 6.2**, however, has a unique amino acid composition, because each is comprised of a unique sequence of amino acids.

Keratins - α -**Keratins** are the major proteins of hair and fingernails and compose a major fraction of animal skin. α -**keratins** are classified in the broad group of intermediate filament proteins, which play important structural roles in nuclei, cytoplasm, and cell surfaces. Their secondary structure is composed predominantly of α -helices. **Figure 6.11** shows the coiled-coil structure of the α -**keratin** in hair. The chemical composition of the cysteine residues in α -**keratin** affects its macromolecular structure and function. For example, hair has relatively few cysteine cross-links, whereas fingernails have many such cross-links. β -**keratins**, on the other hand, contain much more β pleated sheet secondary structure than α -**keratins** and are found in feathers and scales.

Fibroin - **Fibroin** is made by silkworms and spiders and it contains long regions of antiparallel β sheets. Other parts of fibroin are not in the form of β sheets. These contain bulky amino acids that interrupt the β sheet structures and may account for the "stretchiness" of silk fibers. The β sheet regions contain, almost exclusively, multiple repetitions of the sequence:



Notice that almost every other residue is a glycine and that between them lie either alanine or serine residues. This repeating structure results in simple, tightly organized structures, such as the structure of silk fibroin shown in **Figure 6.12**.

Collagen - **Collagen** is the single most abundant protein in most vertebrates - up to a third of the total protein mass. Collagen fibers provide the matrix of bone on which mineral constituents precipitate. The fibers constitute a major portion of tendons and a network of collagen fibers is present in skin. The triple-helix tropocollagen molecule is the basic unit of the collagen fiber. Composed of about 1000 amino acids each, the individual chains of tropocollagen contain a left-handed helical structure, but are wound

together with the other two chains of the fiber in a right-handed manner. This unique structure is shown in [Figure 6.13](#). Every third residue lies near the center of the triple helix and can only be glycine, because all other amino acid side chains would be too bulky. The repeating amino acid sequence is Gly-X-Y, where X is often proline and Y is proline or hydroxyproline (a modified form of proline). Collagen is unusual not only in having modified amino acid residues, such as [hydroxyproline](#) and [hydroxylysine](#), but also in having so many of them. Hydroxyproline helps to stabilize the triple helix via [hydrogen bonds](#). Hydroxylysine functions to form attachment sites for polysaccharides. Hydroxylation of proline requires ascorbic acid ([vitamin C](#)). Deficiency of vitamin C reduces hydroxyproline production, leading to weakened collagen fibers and the condition known as scurvy. Part of collagen's toughness arises from cross-links between lysine residues of adjacent chains. This cross linking reaction occurs throughout life and makes bones, skin, and tendons less elastic - properties we associate with aging.

[Elastin](#) - Elastin is a highly elastic fiber present in ligaments and arterial blood vessels. The polypeptide is rich in glycine, alanine, and valine. Its secondary structure is the most random of the fibrous proteins described here. Like collagen, elastin contains lysine groups involved in cross-links between the chains. In elastin, however, four lysine chains can be combined to form a desmosine cross-link (see [here](#)). Thus, fewer cross-links are needed to provide strength for the chains and a more elastic network is created.

See also: [Collagen Synthesis](#), [Globular Proteins](#)

Table 6.2



Amino Acid	α -Keratin (Wool)	Fibroin (Silk)	Collagen (Bovine Tendon)	Elastin (Pig Aorta)
Gly	8.1	44.6	32.7	32.3
Ala	5.0	29.4	12.0	23.0
Ser	10.2	12.2	3.4	1.3
Glu + Gln	12.1	1.0	7.7	2.1
Cys	11.2	0	0	— ^e
Pro	7.5	0.3	22.1 ^a	10.7 ^c
Arg	7.2	0.5	5.0	0.6
Leu	6.9	0.5	2.1	5.1
Thr	6.5	0.9	1.6	1.6
Asp + Asn	6.0	1.3	4.5	0.9
Val	5.1	2.2	1.8	12.1
Tyr	4.2	5.2	0.4	1.7
Ile	2.8	0.7	0.9	1.9
Phe	2.5	0.5	1.2	3.2
Lys	2.3	0.3	3.7 ^b	3.6 ^d
Trp	1.2	0.2	0	— ^e
His	0.7	0.2	0.3	— ^e
Met	0.5	0	0.7	— ^e

Note: The three most abundant amino acids in each protein are indicated in red. Values given are in mole percent.

^aAbout 39% of this is hydroxyproline.

^bAbout 14% of this is hydroxylysine.

^cAbout 13% of this is hydroxyproline.

^dMost (about 80%) is involved in cross-links.

^eEssentially absent.

Keratins

Two important classes of proteins that have similar amino acid sequences and biological function are called α - and β -keratins. The α -keratins are the major proteins of hair and fingernails and compose a major fraction of animal skin. The α -keratins are members of a broad group of intermediate filament proteins, which play important structural roles in the nuclei, cytoplasm, and surfaces of many cell types. All of the intermediate filament proteins are predominantly α -helical in structure; in fact, it was the characteristic x-ray diffraction pattern of α -keratin that Pauling and his colleagues sought to explain by their α -helix model.

The structure of a typical α -keratin, that of hair, is depicted in [Figure 6.11](#). The individual molecules contain long sequences—over 300 residues in length—that are wholly α -helical. Pairs of these helices twine about one another in the left-hand coiled-coil structure shown in the lower portion of [Figure 6.11](#). The mutual wrapping is such that the amino acid side chains (most of which are small in α -keratin—see [Table 6.2](#)) interdigitate. In hair, two of the coiled coils then further twist together to form a 4-molecule protofibril, as shown in the upper portion of [Figure 6.11](#). Finally, eight protofibrils combine in either a circular or a square arrangement to make the microfibril that is the basis of hair structure. Such twisted cables are stretchy and flexible, but in different tissues α -keratin is hardened, to differing degrees, by the introduction of disulfide cross-links within the several levels of fiber structure. (Note that α -keratin has an unusually high content of [cysteine](#)—see [Table 6.2](#).) Fingernails have many cross-links in their α -keratin, whereas hair has relatively few. The process of introducing a "permanent wave" into human hair involves reduction of these disulfide bonds, rearrangement of the fibers, and reoxidation to "set" the waves thus introduced.

The β -keratins, as their name implies, contain much more β -sheet structure. Indeed, they represented the second major structural class described by Pauling and co-workers. The β -keratins are found mostly in birds and reptiles, in structures like feathers and scales.

See also: [Fibrous Proteins](#), [\$\alpha\$ -Helix](#), [\$\beta\$ -Sheet](#), [Cysteine](#)

Elastin

Some tissues, such as ligaments and arterial blood vessels, need highly elastic fibers. Such tissues contain large amounts of the fibrous protein **elastin**.

The polypeptide chain of elastin is rich in [glycine](#), [alanine](#), and [valine](#) and is very flexible and easily extended. In fact, its conformation probably approximates that of a random coil, with little secondary structure at all. However, the sequence also contains frequent lysine side chains, which can be involved in cross-links. These cross-links prevent the elastin fibers from being extended indefinitely, causing the fibers to snap back when tension is removed. The cross-links in elastin are rather different from those in [collagen](#), for they are designed to hold several chains together. Four [lysine](#) side chains can be combined to yield a desmosine cross-link: (see [here](#))

Because the α carbons of four separate chains are connected, only a small amount of such cross-linking is needed to convert **elastin** fibers into a highly interconnected, rubbery network.

See also: [Fibrous Proteins](#)

Unnumbered Item

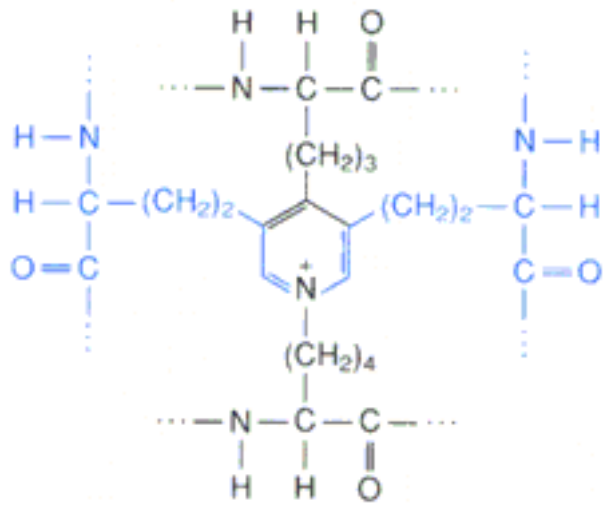

Collagen Synthesis

Collagen synthesis is shown schematically in [Figure 6.14](#). Steps include the following:

1. Translation on the [ribosome](#) (synthesizing the primary structure);
2. Hydroxylation of the [lysine](#) and [proline](#) side chains (still on the ribosome);
3. Release from the ribosome and addition of sugars to lysines to create procollagen;
4. Assembly of central regions into triple helices/folding of N-terminal and C-terminal ends into globular structures;
5. Export of procollagen complexes from the cytosol to the extracellular space;
6. Cleavage of N-terminal and C-terminal regions, yielding the tropocollagen triple helix;
7. Oxidation of some lysine residues to aldehyde derivatives, which cross-link with lysine residues or one another on other strands to solidify the fiber (see [here](#)).

See also: [Fibrous Proteins](#), [Collagen](#), [Hydroxyproline](#), [Hydroxylysine](#)

Unnumbered Item

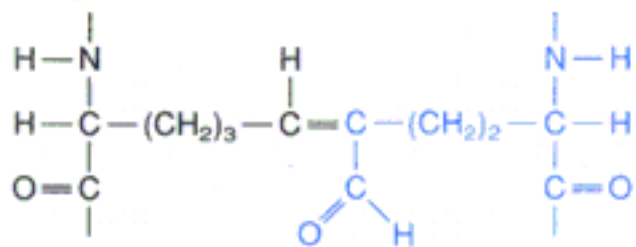

Globular Proteins

The two major classes of proteins are the fibrous proteins and the **globular proteins**. Fibrous proteins are structural proteins. They are very abundant in cells. **Globular proteins**, on the other hand, far outnumber fibrous proteins. **Globular proteins** perform most of the chemical "work" of the cell - synthesis, transport, and catabolism. They are folded into compact structures very unlike the extended, filamentous forms of the fibrous proteins.

X-ray diffraction technology has enabled scientists to determine atomic positions in **globular proteins** to within 0.3 nm, a resolution sufficient to identify individual amino acid residues. The general structure of one **globular protein**, myoglobin, is shown in [Figure 6.1](#).

Globular proteins illustrate the concept of tertiary structure - which arises from folding of the polypeptide chain upon itself. Unlike secondary structure, which is caused by interactions between amino acids close to each other, tertiary structures are seen to be stabilized by interactions between amino acids that are often far apart. Tertiary structures have little regularity. Because they arise from folding of secondary structures, which are dependent on the primary amino acid sequence, tertiary structures are specific for each protein sequence. Similarities in tertiary structure can usually be seen, however, in proteins with similar amino acid sequences.

[Figure 6.16](#) schematically depicts differences in tertiary structure between six different proteins. In this figure, color coding is used to identify the α helical (blue) and β sheet (orange) secondary structures. Notice that the secondary structures, which are common to all of the proteins are folded in such a way that none of the overall molecular shapes looks the same. Despite the apparent chaos of tertiary folding, there are several general rules that have been observed:

1. Folds favor orientation of amino acid residues in specific ways that pack hydrophobic amino acid residues on the inside of the protein (away from water) and hydrophilic amino acid residues on the outside of the protein.
2. β sheets are usually twisted, or wrapped into barrel structures (see immunoglobulin and prealbumin in [Figure 6.16](#)).
3. Turns (interruptions between secondary structures) can occur in a number of ways. They usually occur at the surface of proteins. [Figure 6.18](#) depicts two examples of β turns, which completely reverse the direction of the polypeptide chain in only four amino acid residues. This occurs via hydrogen bonding between residues 1 and 4. A tighter turn, called the γ turn, is shown in [Figure 6.19](#). It occurs in only 3 residues.
4. Not all parts of **globular proteins** can be classified as α helix, β sheets, or turns. These

other regions depicted in green in [Figure 6.16](#) are sometimes described as irregularly structured regions and random coils. An irregular region is a non-regular structure that is stable enough to be seen by x-ray crystallographic analysis. A random coil, by contrast, has so many possible structures as to be random at any given time. It does not crystallize readily so its structure cannot be determined by x-ray diffraction. Be aware, though, that the term random coil is often used inaccurately to also describe irregularly structured regions.

See also: [Fibrous Proteins](#), [Secondary Structure \(General\)](#), [\$\alpha\$ -Helix](#), [\$\beta\$ -Sheets](#), [\$\beta\$ -Turns](#)

Figure 6.16: Type structures of globular proteins.

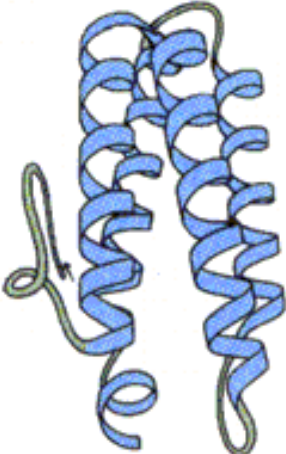

Myohemerythrin

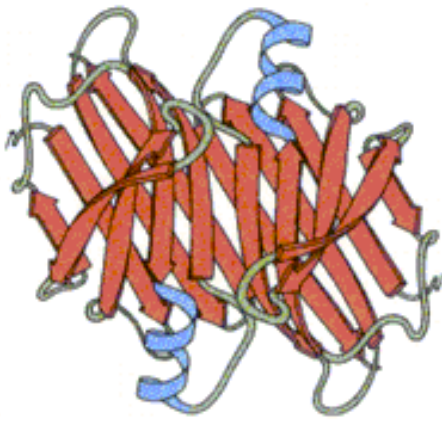

Prealbumin

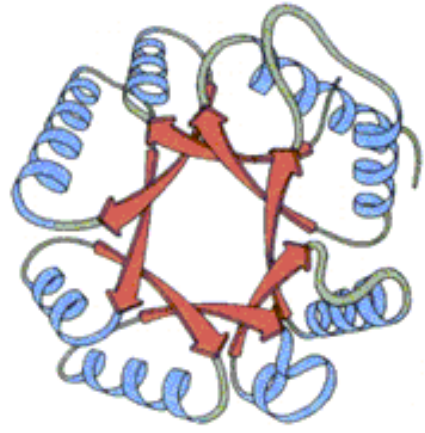

Pyruvate kinase, domain 1

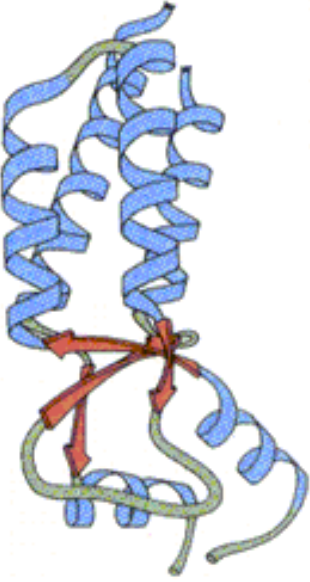

Tobacco mosaic coat protein

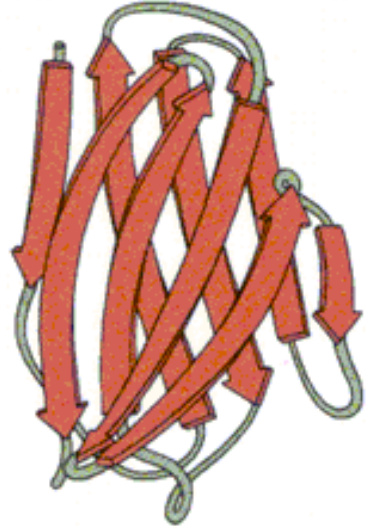

Immunoglobulin, V₂ domain

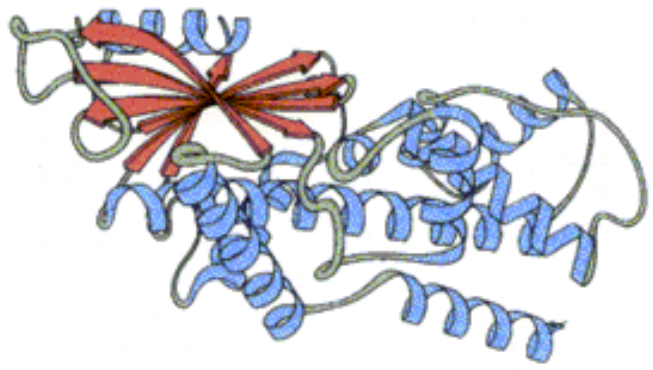

Hexokinase, domain 2

(a) Predominantly α helix

(b) Predominantly β sheet

(c) Mixed α helix and β sheet

Figure 6.18: Examples of β turns.

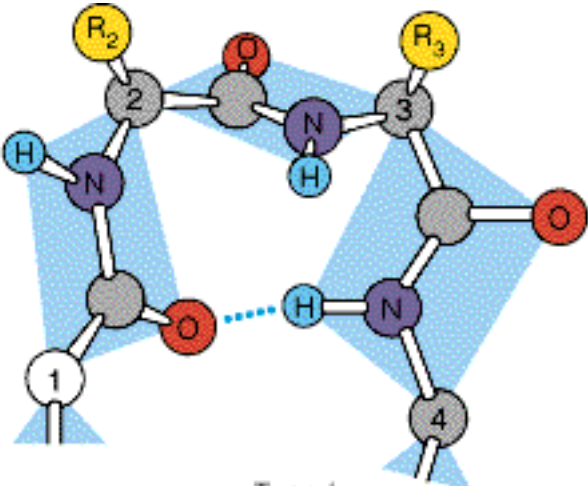

Type I

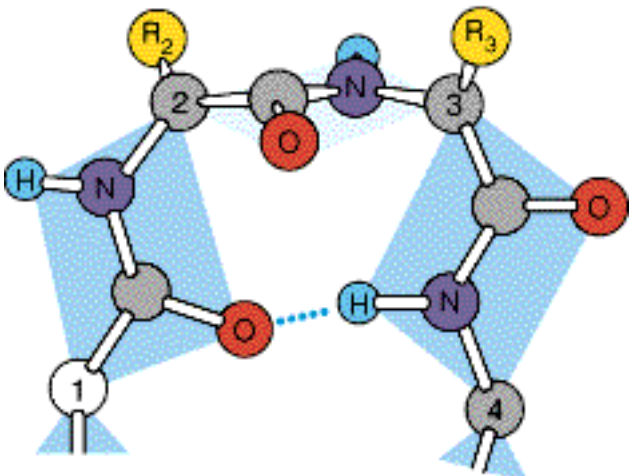

Type II

Figure 6.19: A ψ turn.

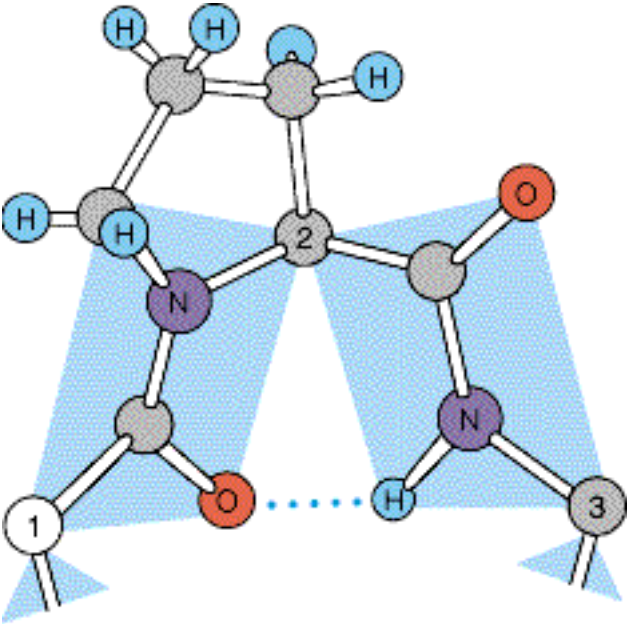

β Turns

A polypeptide chain can turn corners in a number of ways, to go from one β segment or α helix to the next. One kind of compact turn is called a β turn ([Figure 6.18](#)). There are several varieties of β turn, each able to accomplish a complete reversal of the polypeptide chain direction in only four residues; the carbonyl of residue i hydrogen-bonds to the amide hydrogen of residue $i + 3$.

In the even tighter γ turn, bonding is to residue $i + 2$ ([Figure 6.19](#)). Proline often plays a role in turns, as in [Figure 6.19](#), and also as a breaker of α helices, because this residue cannot be accommodated in the helix. Bends and turns most often occur at the surface of proteins.

See also: [Globular Proteins](#), [Prediction of Secondary and Tertiary Protein Structure](#), [Secondary Structure \(General\)](#), [\$\alpha\$ -Helix](#), [\$\beta\$ -Sheets](#)

Prediction of Secondary and Tertiary Protein Structure

Because the sequence of amino acids in a polypeptide ultimately determines its secondary and tertiary structures, investigators have examined the structures found in proteins and tried to relate them to the individual amino acids.

Secondary Structure - [Table 6.6](#) lists the relative probabilities that a particular amino acid will form an α -helix, β -sheet, and a "turn" in proteins. Note that the top group of amino acids favors α -helices, the middle group favors β -sheets, and the last group favors turns.

The Chou-Fasman rules for predicting secondary structure of a region of a polypeptide sequence are the following:

1. Any segment of 6 residues or more with an α -helix probability of over 1.03, and not including [proline](#) or [phenylalanine](#), is predicted to be α -helix.
2. Any segment of 5 residues or more, with β -sheet probability greater than 1.05 (except [histidine](#)) is predicted to be β -sheet.
3. Tetrapeptides with an α helix probability less than 0.9 and a turn probability greater than a β -sheet probability have a good chance of being turns.

[Figure 6.28](#) shows the amino acid sequence of bovine pancreatic trypsin inhibitor ([BPTI](#)). More importantly, [Figure 6.28](#) compares the secondary structures observed in the native protein and predicted by the Chou-Fasman rules. Note that exceptionally good agreement is found between the predicted and observed structures.

Tertiary Structure - Attempts to predict tertiary structure of proteins have not been as successful as those for predicting secondary structure. Folding of sequences depends critically on specific side chain interactions, often far removed from one another in the amino acid sequence. Attempts to predict tertiary structure include efforts to recognize overall patterns in tertiary folding combined with the prediction of secondary structure. These efforts have led to the successful prediction of an α/β -barrel structure for [tryptophan synthase](#), which is in excellent agreement with the structure determined by x-ray diffraction.

Free Energy Minimization - Another approach to predicting tertiary structure uses computer simulation to minimize free energy in spontaneous folding. The computer rotates random-coil chains through a very large number of small permutations in its conformation, calculates the energy of each, and seeks an energy minimum. A simple random search, however, runs into the Levinthal problem (see [here](#)). Several approaches have been taken towards simplifying the search. One of these, called Local

Independently Nucleated Units of Structure (LINUS) breaks the problem down by first identifying local regions likely to have a particular secondary structure and then folds them together to minimize the energy.

See also: [Factors Determining Secondary and Tertiary Structure](#), [Thermodynamics of Protein Folding](#), [Dynamics of Protein Folding](#)

INTERNET LINKS:

1. [NNPredict - Protein Secondary Structure Prediction](#)
 2. [Molecular Analysis of Protein Structure](#)
 3. [Homology Modeling](#)
 4. [Multiple Alignments, Sequence Motifs and Structure Inference](#)
 5. [The Predict Protein Server](#)
-

Table 6.6

A. Relative probabilities of amino acid residue occurrence in different globular protein secondary structures^a

Amino Acid	α Helix (P_α)	β Sheet (P_β)	Turn (P_t)	
Ala	1.29	0.90	0.78	} Favor α helices
Cys	1.11	0.74	0.80	
Leu	1.30	1.02	0.59	
Met	1.47	0.97	0.39	
Glu	1.44	0.75	1.00	
Gln	1.27	0.80	0.97	
His	1.22	1.08	0.69	
Lys	1.23	0.77	0.96	
Val	0.91	1.49	0.47	} Favor β sheets
Ile	0.97	1.45	0.51	
Phe	1.07	1.32	0.58	
Tyr	0.72	1.25	1.05	
Trp	0.99	1.14	0.75	
Thr	0.82	1.21	1.03	
Gly	0.56	0.92	1.64	} Favor turns
Ser	0.82	0.95	1.33	
Asp	1.04	0.72	1.41	
Asn	0.90	0.76	1.23	
Pro	0.52	0.64	1.91	
Arg	0.96	0.99	0.88	

B. Chou–Fasman rules for prediction^b

1. Any segment of six residues or more, with $\langle P_\alpha \rangle \geq 1.03$, as well as $\langle P_\alpha \rangle > \langle P_\beta \rangle$, and not including Pro, is predicted to be α helix.
2. Any segment of five residues or more, with $\langle P_\beta \rangle \geq 1.05$, and $\langle P_\beta \rangle > \langle P_\alpha \rangle$, is predicted to be β sheet.
3. Examine the sequence for tetrapeptides with $\langle P_\alpha \rangle < 0.9$, $\langle P_t \rangle > \langle P_\beta \rangle$. They have a good chance of being turns. The actual rules for predicting β turns are more complex, but this method will work in most cases.

^aData adapted from M. Levitt, *Biochemistry* (1978) 17:4277–4285.^bAdapted with permission from P. Y. Chou and G. D. Fasman, *Biochemistry* (1974) 13:222–245. © 1974 American Chemical Society. The symbols $\langle P_\alpha \rangle$, $\langle P_\beta \rangle$, and $\langle P_t \rangle$ denote *average* values of these quantities in a region of the sequence.

^bAdapted with permission from P. Y. Chou and G. D. Fasman, *Biochemistry* (1974) 13:222–245. © 1974 American Chemical Society. The symbols $\langle P_\alpha \rangle$, $\langle P_\beta \rangle$, and $\langle P_i \rangle$ denote *average* values of these quantities in a region of the sequence.

Figure 6.28: Prediction of the secondary structure of BPTI.



PREDICTED OBSERVED

	1	
α helix	R	R
	P	P
	D	D
	F	F
	C	C
	L	L
	E	E
	P	P
	Y	Y
	T	T
10		
β sheet	G	G
	P	P
	C	C
	K	K
	A	A
	R	R
	I	I
	I	I
	R	R
	Y	Y
20		
β sheet	F	F
	Y	Y
	N	N
	A	A
	K	K
	A	A
	G	G
	L	L
	C	C
	Q	Q
30		
β sheet	T	T
	F	F
	V	V
	Y	Y
	G	G
	G	G
	C	C
	R	R
	A	A
	K	K
40		
β sheet	R	R
	N	N
	N	N
	F	F
	K	K

α helix

N
N
F
K
S
A
E
D
C
M
R
T
C
G
G
A

50

α helix

N
N
F
K
S
A
E
D
C
M
R
T
C
G
G
A

Tryptophan Synthase

The structure of the last enzyme in the synthesis of tryptophan, **tryptophan synthase**, consists of an $\alpha_2\beta_2$ dimer in which the separate subunits apparently catalyze the reactions ([Figure 21.14](#)) in the enzyme and actually transfer the indol product through a tunnel in the interior part of the molecule. A schematic depiction of the **tryptophan synthase** reactions is shown in [Figure 21.16](#).

See also: [Metabolism of Aromatic Amino Acids and Histidine](#), [Tryptophan](#)

INTERNET LINK: [Phenylalanine, Tyrosine, and Tryptophan Biosynthesis](#)

Figure 21.16: Schematic depiction of the action of tryptophan synthase in one a-b subassembly.

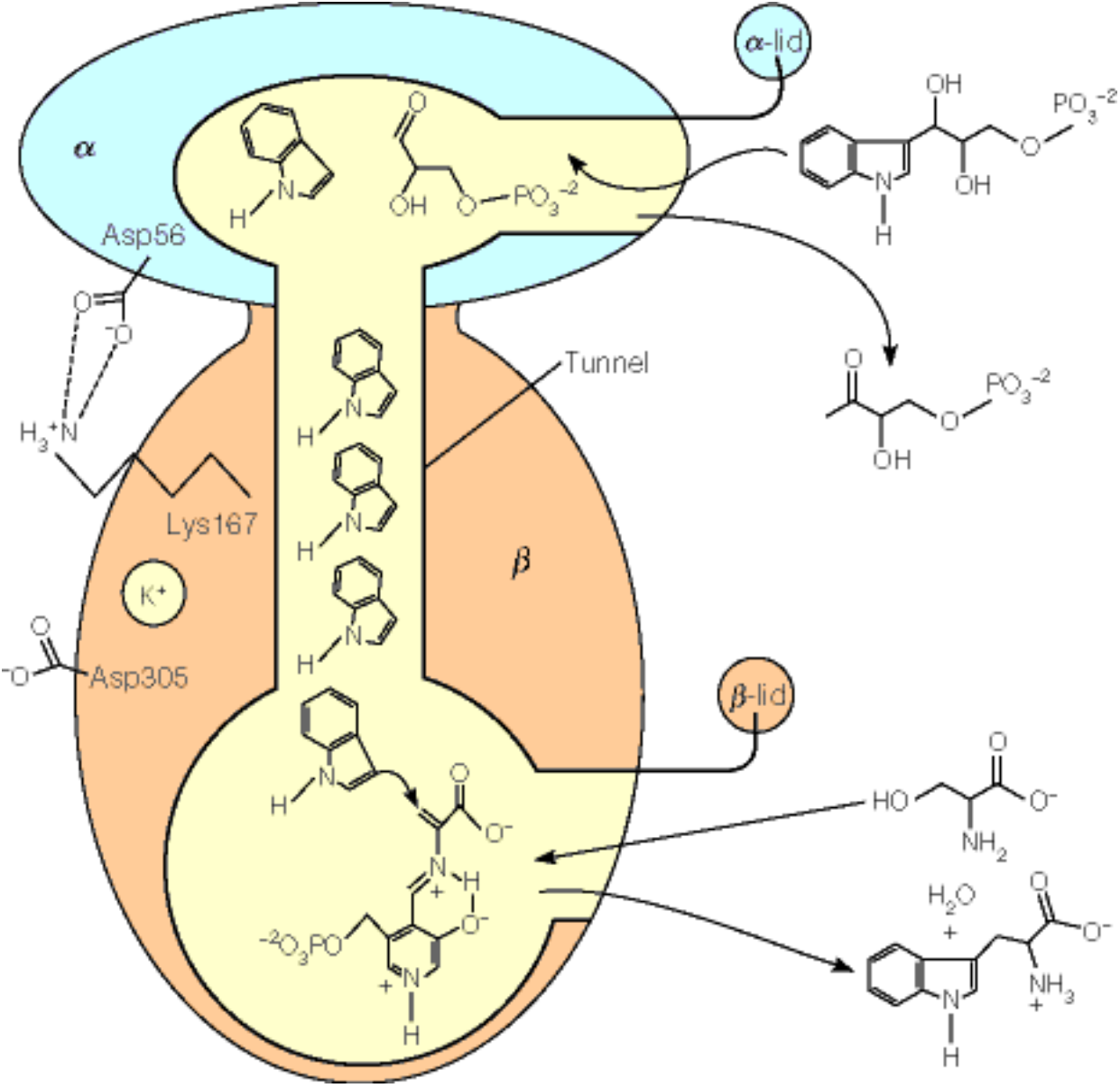

Courtesy of P. Pan, E. Woehl, and M. F. Dunn, Trends in Biochem. Sci. (1997) 22:22-27. © 1997 with permission of Elsevier Science.

Dynamics of Protein Folding

Folding Paradox - Levinthal's paradox states that there are approximately 10^{50} possible conformations for a protein, such as ribonuclease (124 residues). If one new conformation could be attempted every 10^{13} seconds, it would still take over 10^{30} years to randomly test all of the possibilities, yet ribonuclease

can completely fold in about a minute. Thus, folding must not be a completely random phenomenon.

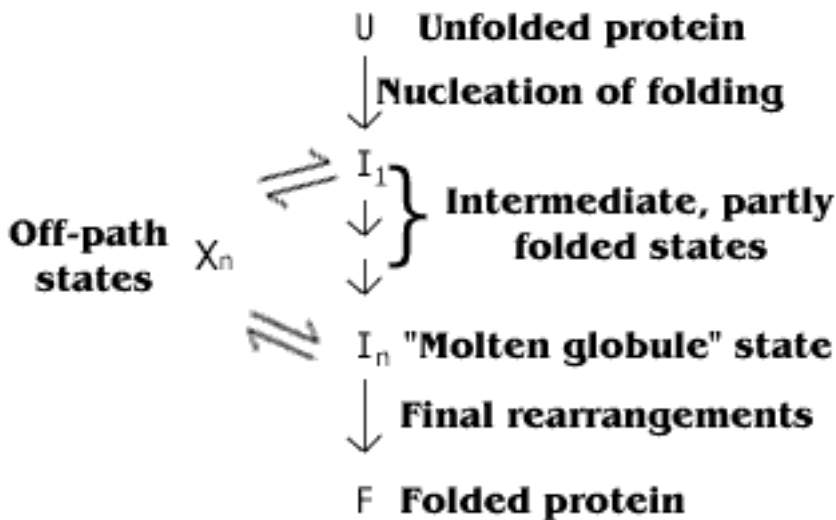

Pathway Model - The "pathway" model of protein folding is depicted at the left. Nucleation is critical because it is much more difficult to begin an α helix than to extend it. Nucleation may start at a number of points and all of these partially folded structures can be "funneled" by energy minimizations toward the final state ([Figure 6.24](#)). Thus, Levinthal's

paradox is averted.

Notice that the funnel in [Figure 6.24](#) has energetic "traps", which correspond to local free energy minima associated with incorrectly folded states. Fortunately, the cell has ways to assist incorrectly folded proteins to find the proper conformation.

Common Errors - One of the most common folding errors occurs via *cis-trans* isomerization of the amide bond adjacent to a proline residue (see [here](#)). Proline is the only amino acid in proteins that forms peptide bonds in which the *trans* isomer is only slightly favored (4 to 1 versus 1000 to 1 for other residues). Thus, during folding, there is a significant chance that the wrong proline isomer will form first. It appears that cells have enzymes to catalyze the *cis-trans* isomerization necessary to speed correct folding.

Disulfide Bond Formation - Proteins with disulfide bonds have a built-in advantage if they are denatured with their disulfide bonds intact. The intact disulfide bonds eliminate many degrees of freedom associated with denaturation, so fewer events need to occur to bring about the correctly folded state. This can be verified by removing the disulfide bonds of a protein and then denaturing it. Refolding of this polypeptide occurs, but at a slower rate than when the disulfides are left intact (see [Figure 6.25](#)). Interestingly, disulfide bonds not found in the native structure sometimes form during intermediate stages of folding. Also, the folding process can be aided by enzymes that make disulfide bonds.

Chaperonins - In addition to the enzymes mentioned previously that assist with proper folding (e.g., *cis-trans* isomerase for proline and disulfide bond making enzymes), cells have a class of proteins called chaperonins, which "chaperone" a protein to help keep it properly folded and non-aggregated.

Aggregation is a problem for unfolded proteins because the hydrophobic residues, which normally are deep inside of a protein, may be exposed when the protein is released from the ribosome. If they are exposed to hydrophobic residues in other strands, the two strands may associate with each other hydrophobically (to aggregate) instead of folding properly. The GroEL-ES complex from E. coli is one such chaperone system. It provides a central cavity in which new protein chains can be "incubated" until they have folded properly ([Figure 6.26](#)).

See also: [Globular Proteins](#), [Factors Determining Secondary and Tertiary Structure](#), [Thermodynamics of Protein Folding](#)

INTERNET LINKS:

1. [The Chaperonin Home Page](#)
 2. [Protein Folding](#)
-

Figure 6.24: Energy surfaces to visualize protein conformations.

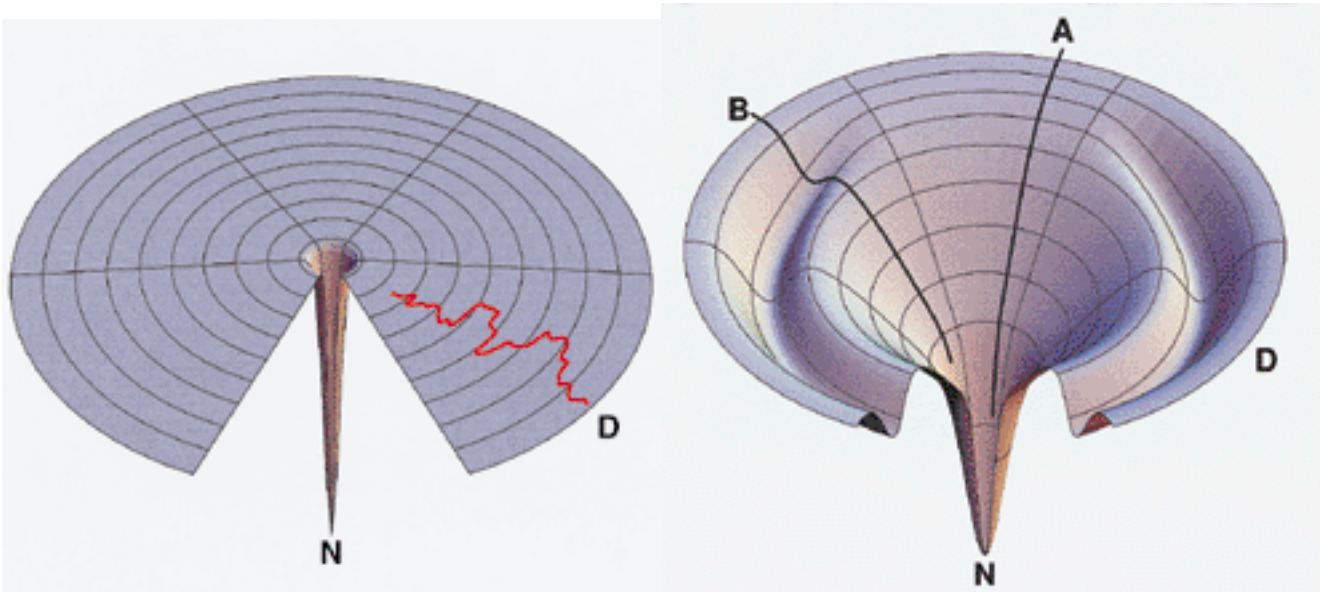

Courtesy of K. Dill and H. S. Chan, Nature Struct. Biol. (1997) 4:10-19.

Unnumbered Item

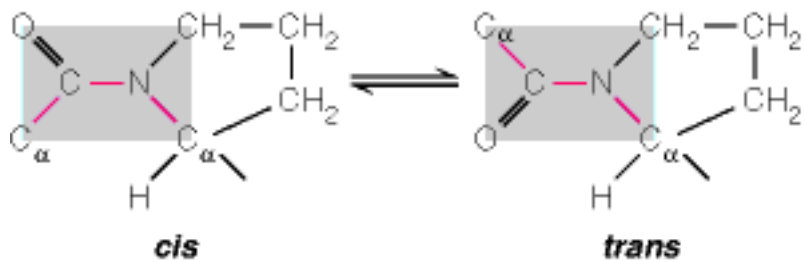
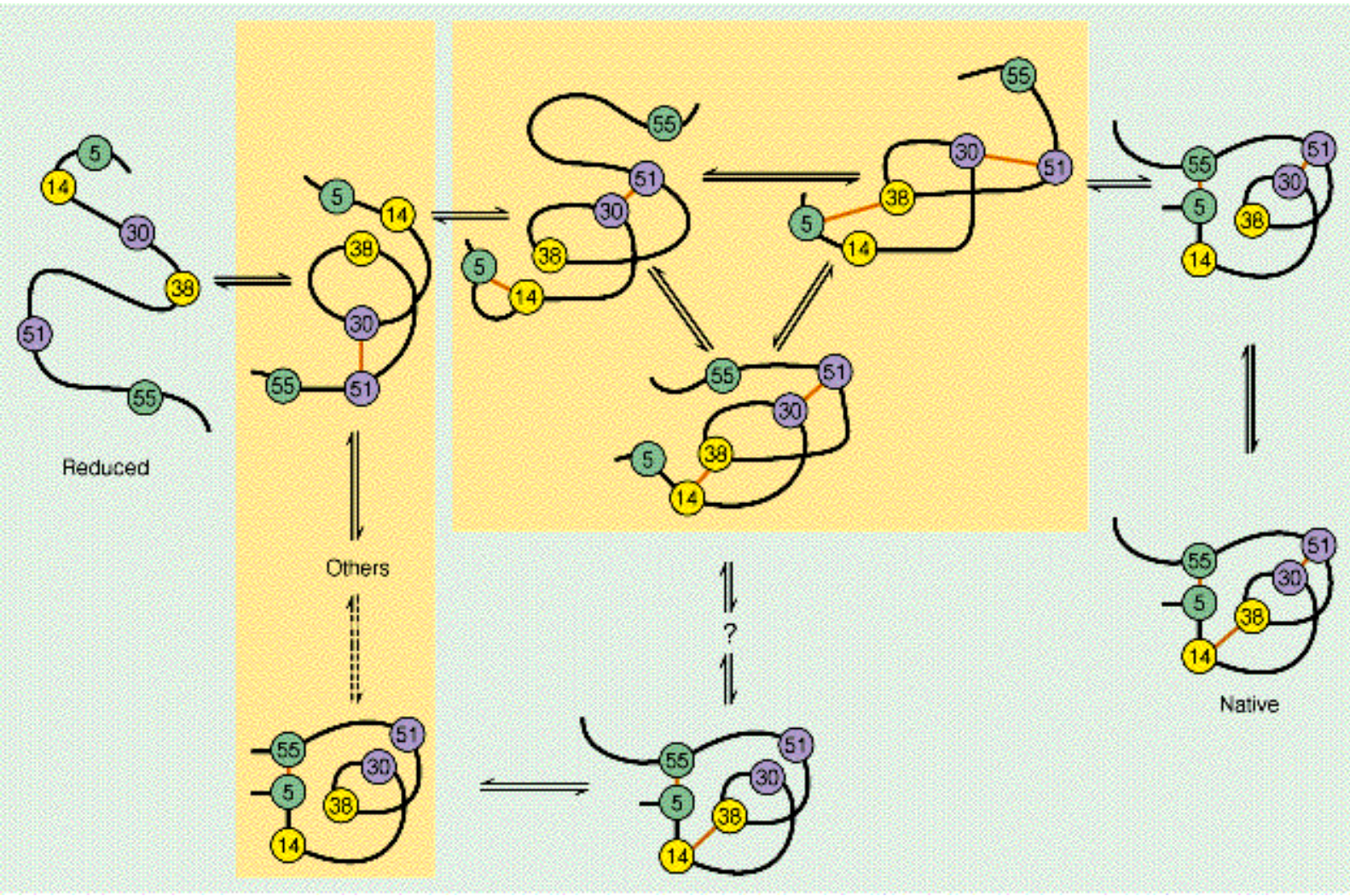

Figure 6.25: Refolding and disulfide bond formation.



Adapted from D. P. Goldenberg, Trends Biochem. Sci. (1992) 17:257-261. © 1992 with permission of Elsevier Science.

Chaperonins

Chaperonins are special proteins (also called **molecular chaperones**) that function to keep a newly synthesized protein from either improperly folding or aggregating. Improper folding may correspond to being trapped in a deep local minimum on the energy landscape. Aggregation is often a danger because the protein, released from the ribosome in an unfolded state, will have hydrophobic groups exposed. These will be tucked inside in normal folding, but when exposed they stand the chance of making hydrophobic interactions with other polypeptide strands and thereby aggregating.

The best studied of all **chaperonins** is the GroEL-ES complex from *E. coli* ([Figure 6.26](#)). It consists of two basic portions - GroEl is made of two rings each consisting of seven protein molecules. The center of each ring is an open cavity, accessible to the solvent at the ends. Either cavity can be "capped" with GroES, which is also a seven-membered ring of smaller subunits.

The cavities provide "shelters" in which new protein chains can be "incubated" until they have folded properly. The GroEL-ES complex does not stipulate the folding pattern - that is left up to the protein itself to do. Insulation from the environment prevents chances for aggregation or misfolding.

It is probable that only a fraction of the proteins made in *E. coli* (or any cells) is processed via **chaperonins**. Some would be too large to be accommodated within the cavity. Others can seemingly fold safely on their own.

See also: [Dynamics of Protein Folding](#), [Polypeptide Chain Folding](#), (from Chapter 27)

INTERNET LINK: [The Chaperonin Home Page](#)

Figure 6.26: The GroEL-GroES chaperonin.

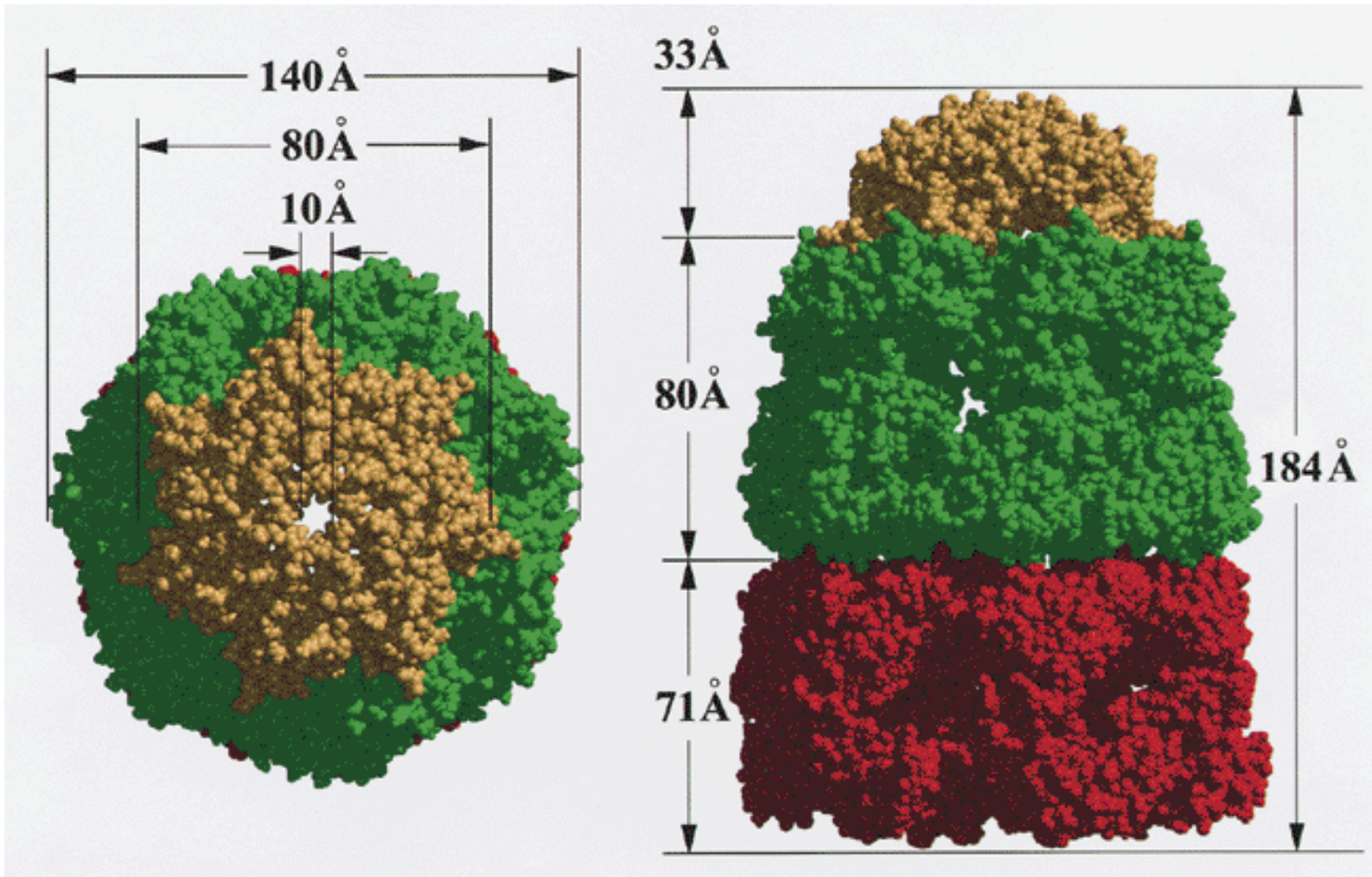

(a) Courtesy of P. B. Sigler from Z. Xu, A. L. Horwich, and P. B. Sigler, *Nature* (1997) 388:741-750. © 1997 Macmillan Magazines, Ltd.; (b) adapted from W. S. Netzer and F. U. Hartl, *Trends Biochem. Sci.* (1998) 23: 68-73. © 1998 with permission from Elsevier Science.

Polypeptide Chain Folding

Before a newly translated **polypeptide** can be active, it must be **folded** into the proper three-dimensional structure and it may have to associate with other subunits.

At the beginning of translation, the first 30 amino acids are protected before they begin to emerge from the **ribosome**. There is good evidence that folding actually begins during translation and in most cases is nearly complete by the time the chain is released. For example, antibodies against the tertiary structure (that is, the folded structure) of the β galactosidase protein will bind to polyribosomes (see [here](#)) in the midst of translation.

This spontaneous folding during translation may be blocked or delayed, however, by chaperone proteins.

See also: [Dynamics of Protein Folding](#) (from chapter 6), [Chaperonins](#), [3D Structural Database](#)

INTERNET LINK: [The Chaperonin Home Page](#)

Rates and Energetics of Translation

At 37°C, an *E. coli* **ribosome** can synthesize a 300-residue polypeptide chain in about 20 seconds. This rate is almost exactly the same as that calculated for prokaryotic transcription. **mRNA** can be **translated** as fast as it is transcribed because it is possible for many ribosomes to simultaneously translate a single message. Such a complex is called a **polyribosome**. Under some conditions, as many as 50 ribosomes may be packed onto a single mRNA.

Given this high rate of synthesis and the fact that *E. coli* contains about 15,000 ribosomes, each cell can synthesize about 750 protein molecules of 300 residues in length per second, at full capacity.

For a polypeptide of N residues, a minimum of $4N$ high energy phosphates (such as **ATP** or **GTP**) must be hydrolyzed. This corresponds to about 50,000 kJ/mol for a typical protein of 300 residues. Per peptide bond, therefore, it costs the cell about 160 kJ of free energy. Note, however, that the free energy change required for peptide bond synthesis in dilute aqueous solution is about 20 kJ/mol. The difference between cellular peptide bond synthesis (160 kJ/mol) and peptide bond synthesis in dilute solutions (20 kJ/mol) is that cellular peptide bond synthesis is not random. That is, making a defined sequence of amino acids comes with an energy cost.

See also: [Translation](#), [Translation Overview](#)

3D Structural Database

Numerous **databases** of interest to molecular biologists are available on the World Wide Web. The **PDB structure database**, the **Entrez 3D Database**, **Swiss 3DImage** and **SCOP** are four of the most powerful and the most commonly used sites.

INTERNET LINKS:

1. [PDBTool](#)
 2. [Entrez 3D Database Searches](#)
 3. [Swiss 3DImage](#)
-

Figure 6.21: Details of hydrogen bonding in a typical protein.

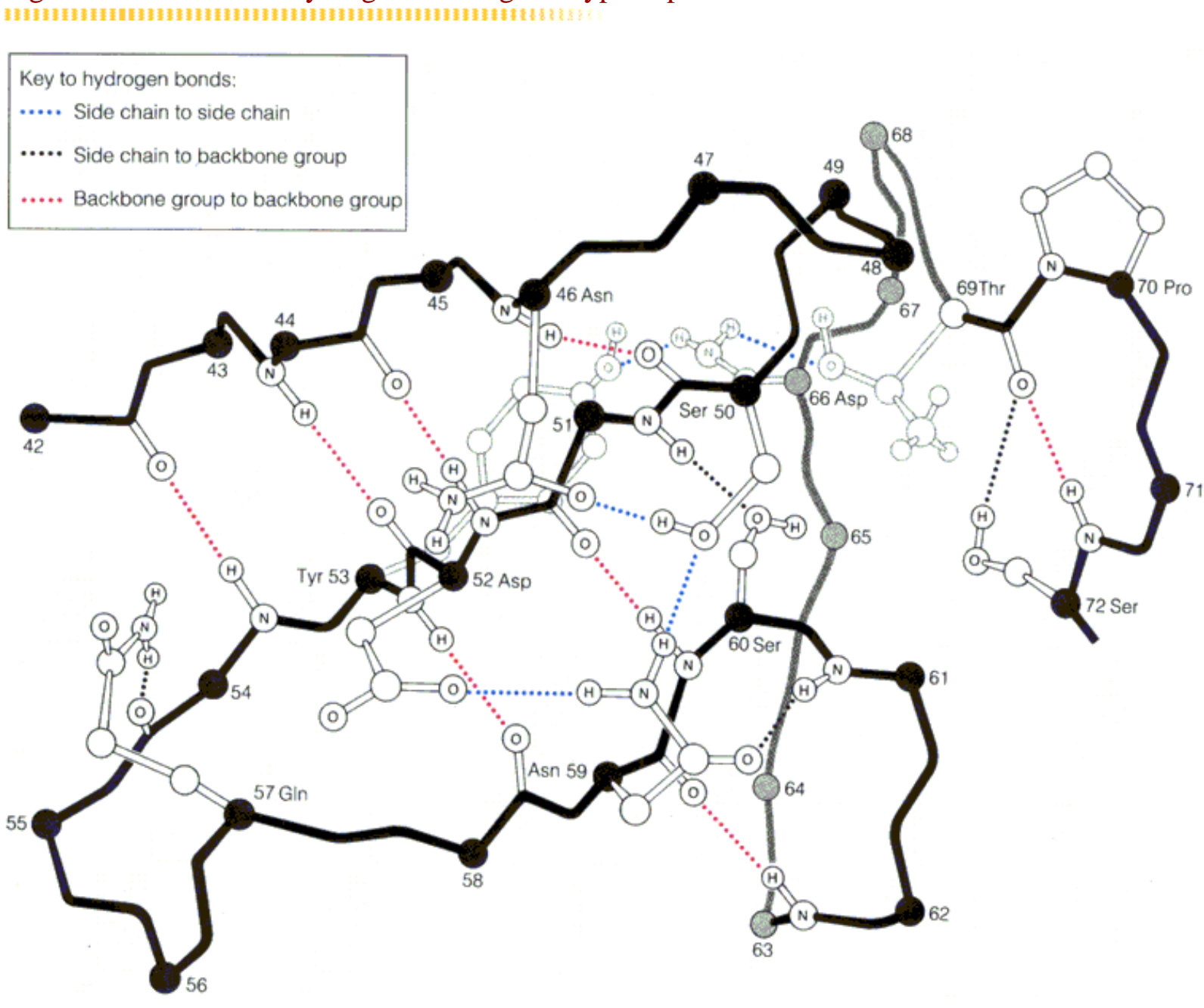

Table 6.4

Amino Acid	Scale of Engelman, Steitz, and Goldman ^a	Scale of Kyte and Doolittle ^b
Phe	3.7	2.8
Met	3.4	1.9
Ile	3.1	4.5
Leu	2.8	3.8
Val	2.6	4.2
Cys	2.0	2.5
Trp	1.9	-0.9
Ala	1.6	1.8
Thr	1.2	-0.7
Gly	1.0	-0.4
Ser	0.6	-0.8
Pro	-0.2	-1.6
Tyr	-0.7	-1.3
His	-3.0	-3.2
Gln	-4.1	-3.5
Asn	-4.8	-3.5
Glu	-8.2	-3.5
Lys	-8.8	-3.9
Asp	-9.2	-3.5
Arg	-12.3	-4.5

^aData from Engelman, D. M., T. A. Steitz, and A. Goldman, *Annu. Rev. Biophys. & Biophys. Chem.* (1986) 15:321–353.

^bData from Kyte, J., and R. F. Doolittle, *J. Mol. Biol.* (1982) 157:105–132.

Table 6.3



Protein	ΔG (kJ/mol)	ΔH (kJ/mol)	ΔS (J/K·mol)
Ribonuclease	-46	-280	-790
Chymotrypsin	-55	-270	-720
Lysozyme	-62	-220	-530
Cytochrome <i>c</i>	-44	-52	-27
Myoglobin	-50	0	+170

Note: Data adapted from P. L. Privalov and N. N. Khechinashvili, *J. Mol. Biol.* (1974) 86:665–684. Each data set has been taken at the pH value where the protein is maximally stable; all are near physiological pH. Data are for the folding reaction: Denatured \rightleftharpoons native.

Figure 9.21: Cellulose structure.

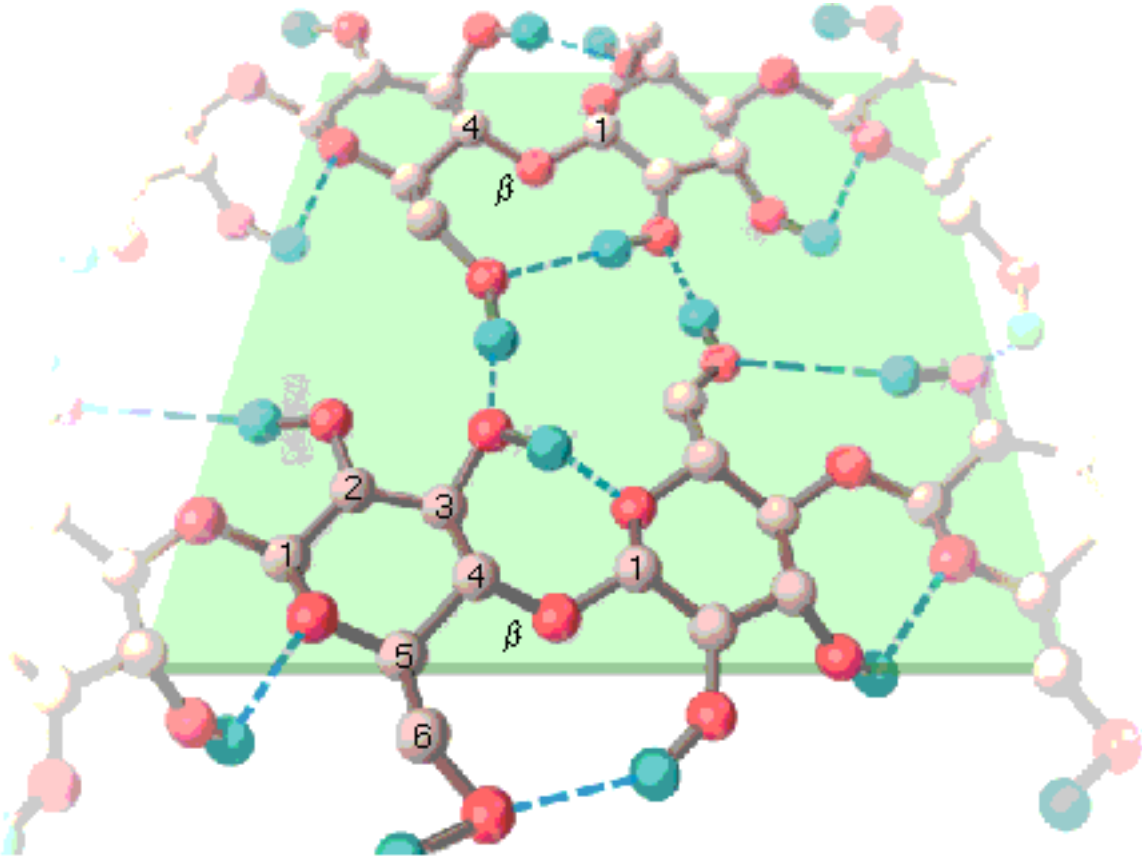

Cellulase



Cellulase is an enzyme found primarily in fungi, lower protozoans, and some symbiotic bacteria in termites and ruminants that digests the β 1- \rightarrow 4 bonds between adjacent glucose units in cellulose.

See also: [Cellulose](#)

Unnumbered Item

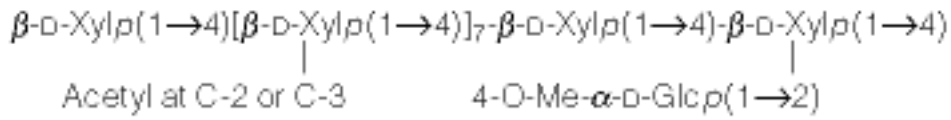

A typical xylan structure

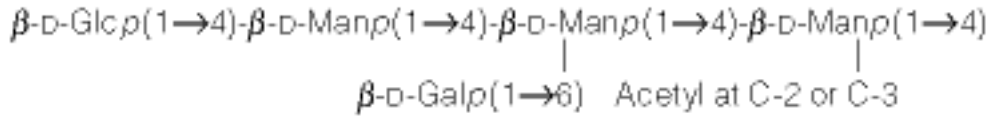

A typical glucomannan structure

D-Xylose

D-Xylose ([Figure 9.9a](#)) is a [monosaccharides](#) containing an aldehyde and five carbons. It is thus an aldopentose.

See also: [Monosaccharide Nomenclature](#),

Undecaprenol Phosphate

Undecaprenol phosphate is involved in synthesis of the microbial cell wall polysaccharides.

See also: [Bacterial Cell Walls](#), [Microbial Cell-Wall Polysaccharides](#), [Bacitracin](#), [Vancomycin](#), [Penicillin](#)

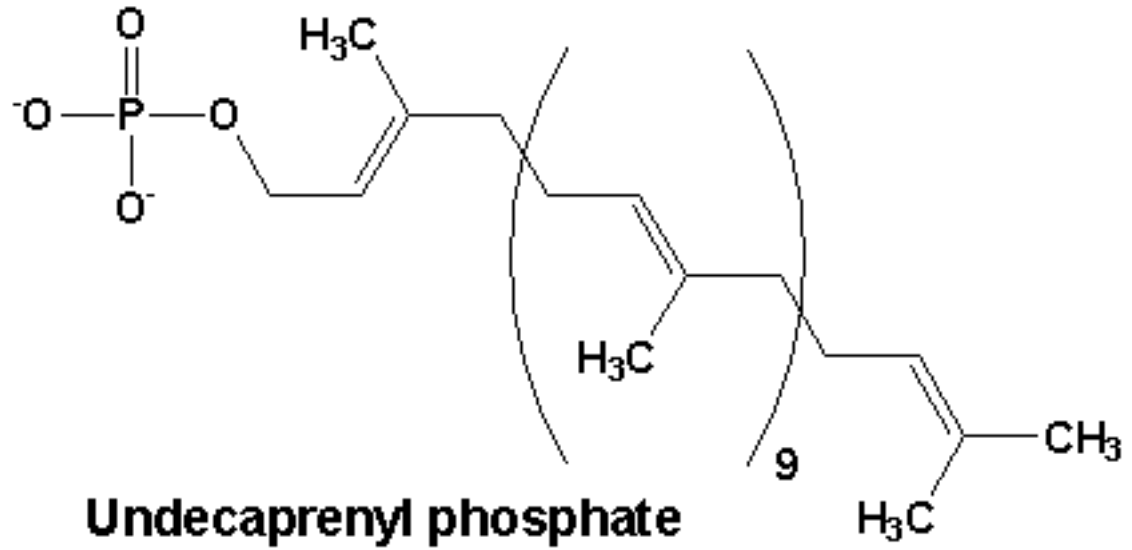

>Bacitracin

Bacitracin is an antibiotic that inhibits bacterial cell wall biosynthesis by inhibiting dephosphorylation of [undecaprenol phosphate](#) (see [Figure 16.20](#))

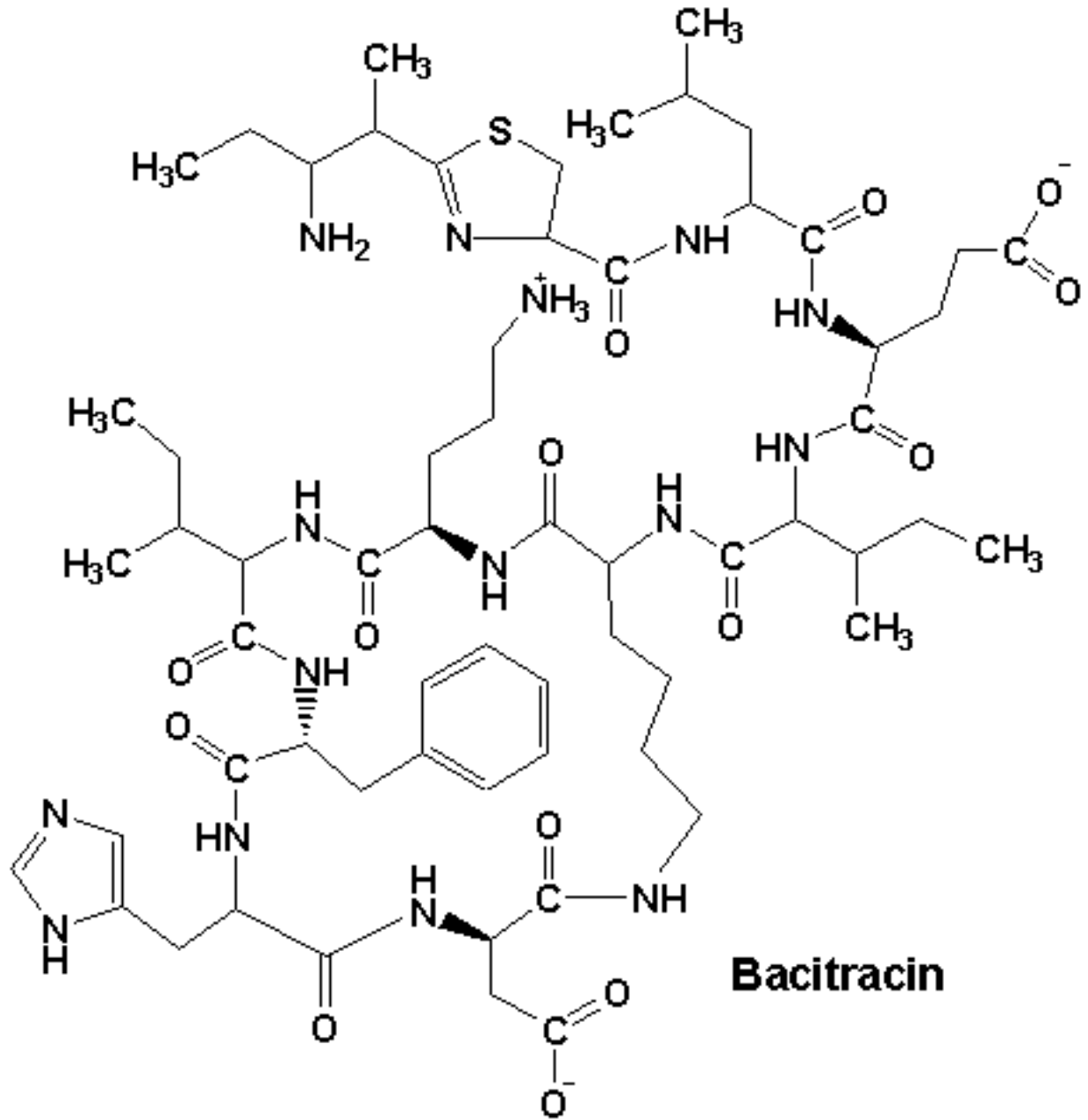

See also: [Vancomycin](#), [Bacterial Cell Walls](#), [Microbial Cell-Wall Polysaccharides](#), [Penicillin](#)

Vancomycin

Vancomycin is an antibiotic that inhibits bacterial cell wall biosynthesis by inhibiting dephosphorylation of **undecaprenol phosphate** (see **Figure 16.20**)

See also:
[Bacitracin](#),
[Bacterial Cell Walls](#), [Microbial Cell-Wall Polysaccharides](#),
[Penicillin](#)

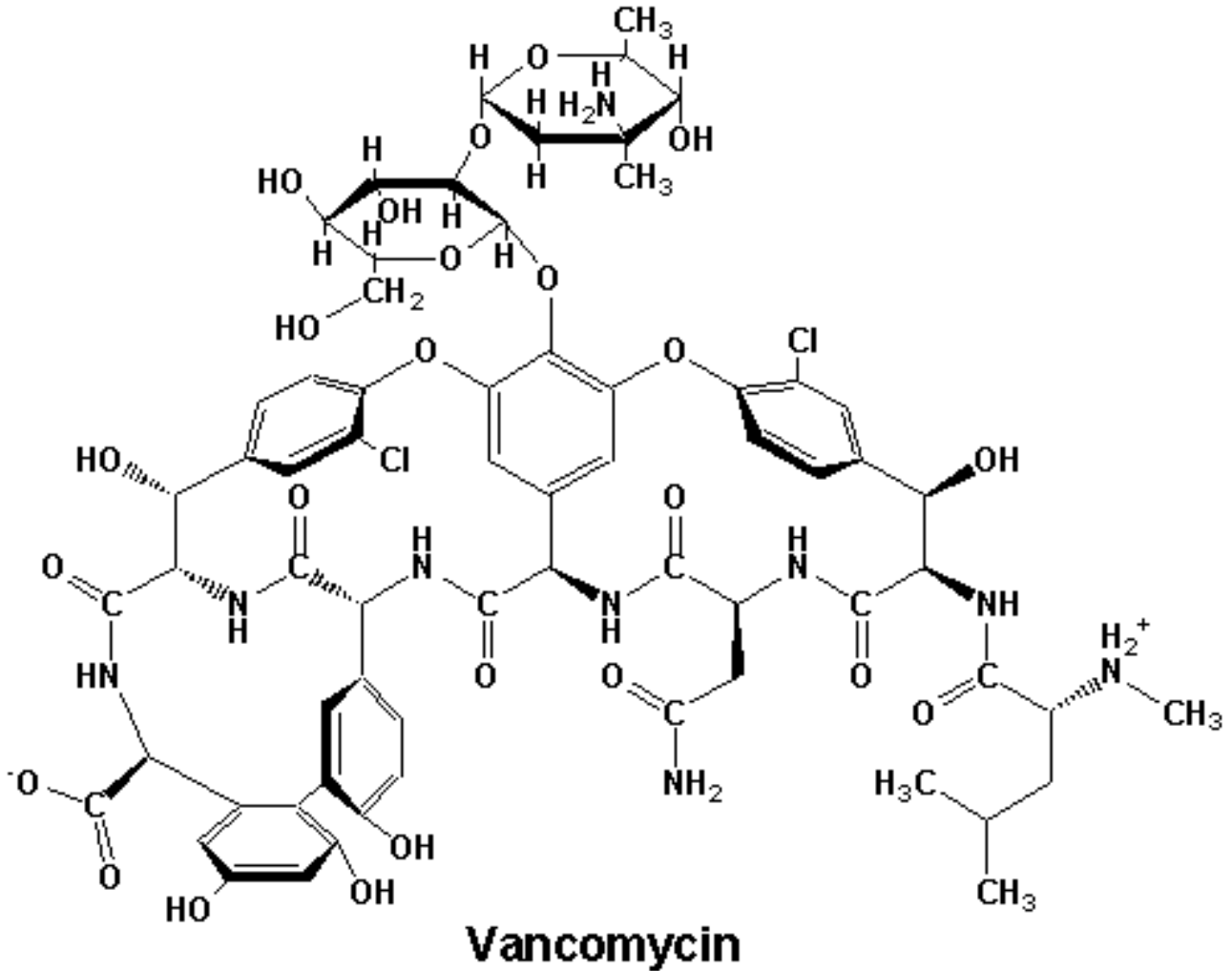

Penicillin

Penicillin is an antibiotic that works by inhibiting the transpeptidase enzyme involved in bacterial cell wall biosynthesis ([Figure 16.21](#)).

Penicillin is thought to react irreversibly with the transpeptidase that catalyzes the cross-linking.

Unfortunately, resistance to penicillin can be acquired by bacteria that synthesize lactamase, an enzyme that hydrolyzes the lactam ring of **penicillin** and destroys its ability to interfere with peptidoglycan synthesis.

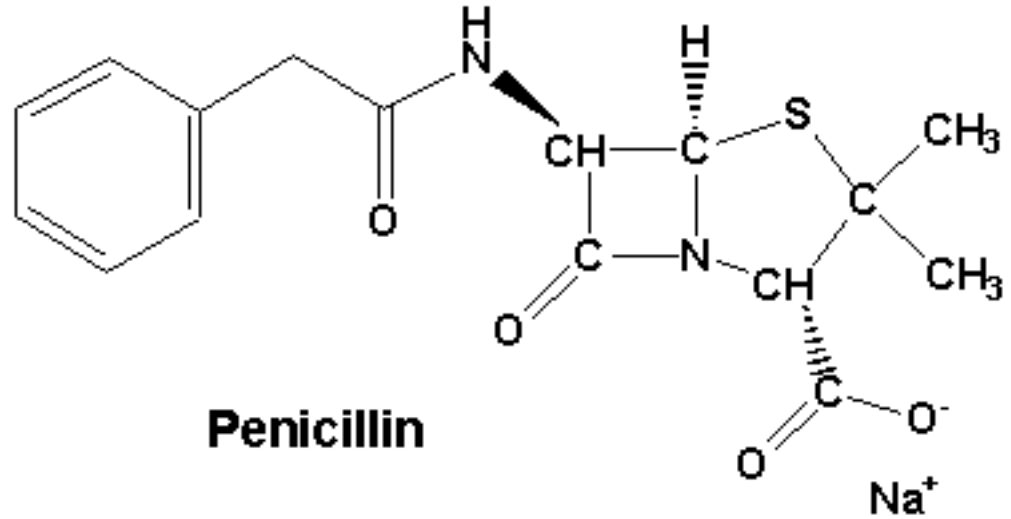

See also: [Bacterial Cell Walls](#), [Microbial Cell-Wall Polysaccharides](#), [Bacitracin](#), [Vancomycin](#),

Figure 16.21: The cross-linking reaction in peptidoglycan synthesis (left) and inhibition of the transpeptidase enzyme, E, by penicillin (right).

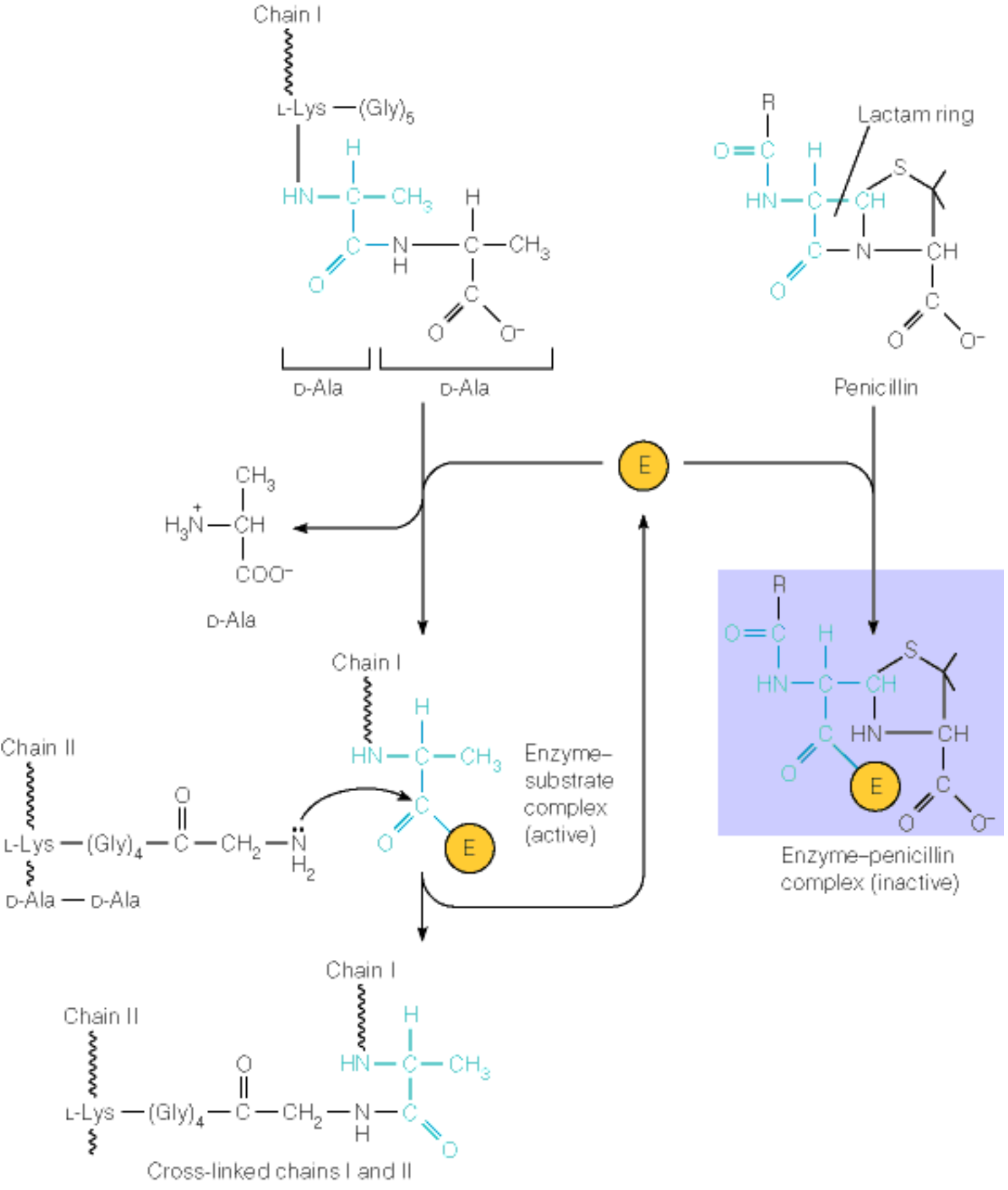
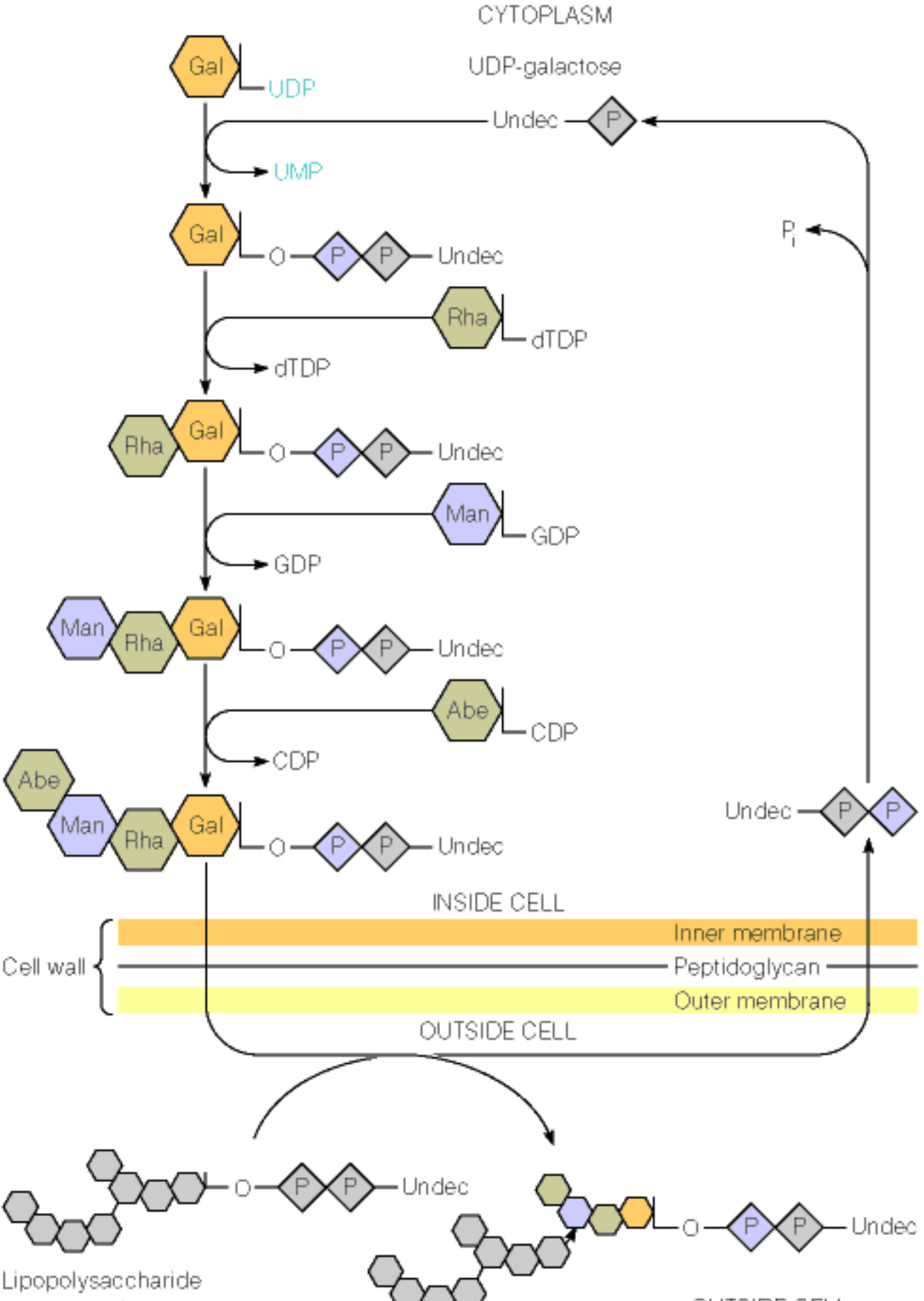







Figure 16.22: Biosynthesis of the repeating oligosaccharide unit of the O antigen of *Salmonella typhimurium*.





Key:

 Galactose	 Mannose	 Rhamnose	 Abequose
Undec —  Undecaprenol phosphate			

GDP-Mannose

GDP-Mannose is the nucleotide sugar that donates **mannose** to **dolichol phosphate** to form **dolichol phospho-mannose**, an important intermediate in synthesis of N-linked glycoproteins.

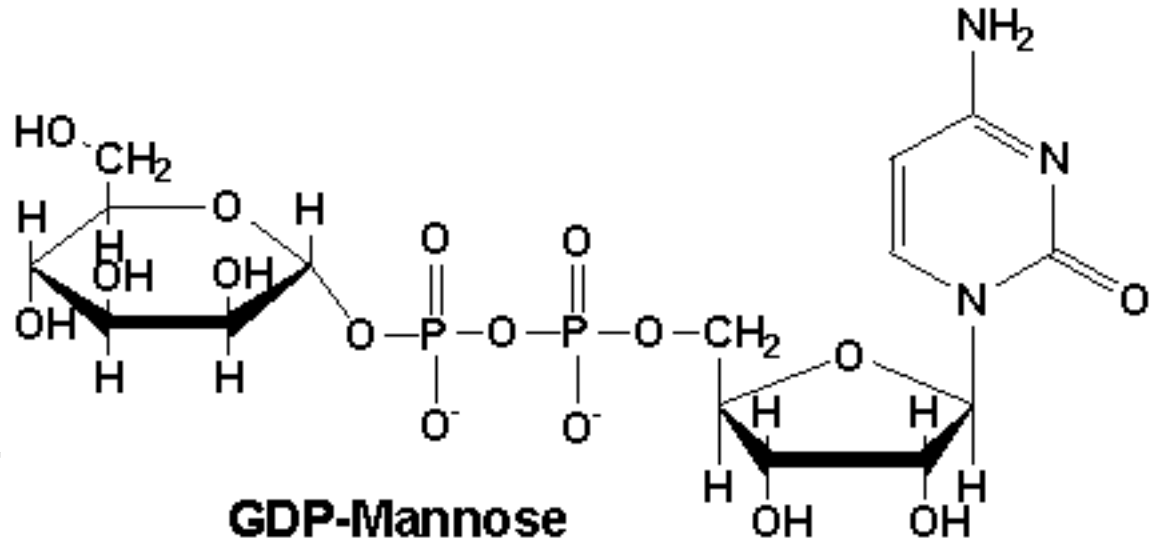

See also: [Biosynthesis of Glycoconjugates](#), [Figure 16.16](#), [Figure 16.17](#).

Dolichol Phospho-Mannose

Dolichol phospho-mannose (Dol-P-Man) is an isoprenoid compound (90-100 carbons total) made from **dolichol phosphate**. It carries mannose to the site of assembly of oligosaccharides to be used

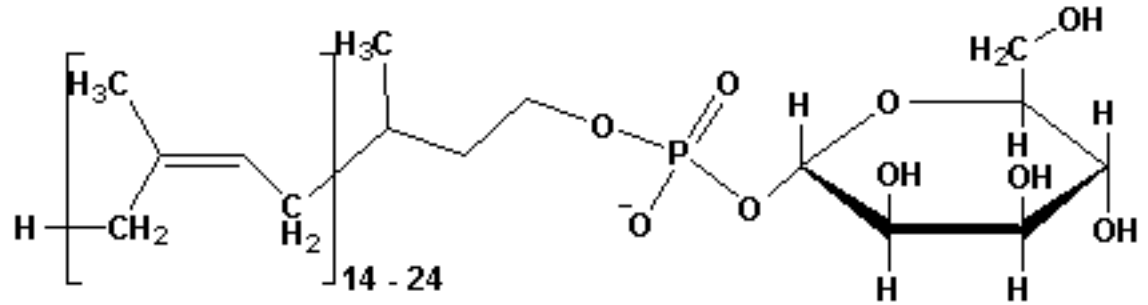

Dolichol Phospho-mannose

to make **N-linked glycoproteins**. **Dol-P-Man** is made from dolichol phosphate and **GDP-Mannose**.

See also: [Biosynthesis of Glycoconjugates](#), [Dolichol](#), [Dolichol-P-Glucose](#)

Dolichol Phospho-Glucose

Dolichol phospho-glucose (Dol-P-Glu)

is an isoprenoid compound (90-100 carbons total) made from dolichol

phosphate. It

carries glucose to the site of assembly of oligosaccharides

to be used to make N-linked glycoproteins. Dol-P-Glu is made from dolichol phosphate and UDP-glucose.

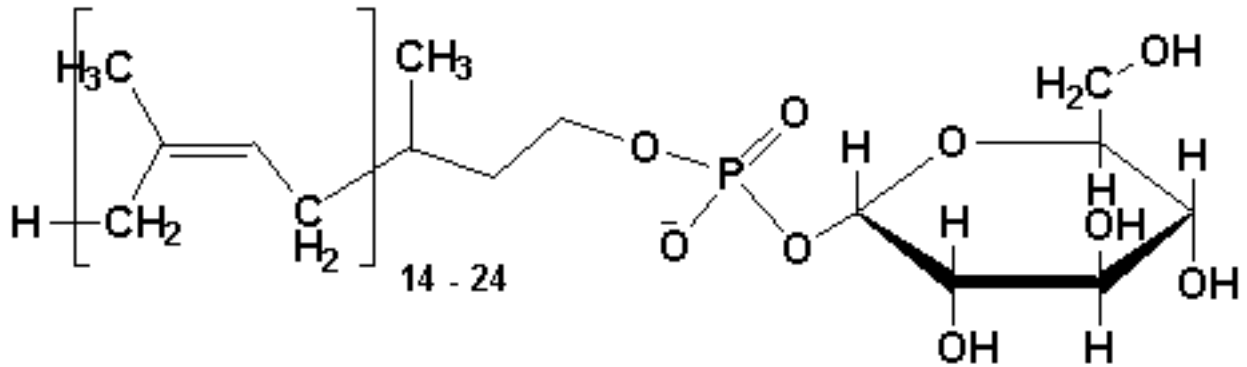

Dolichol Phospho-glucose

See also: Biosynthesis of Glycoconjugates, Dolichol, Dolichol-P-Mannose

L-Fucose

L-Fucose is rare L sugar found of the oligosaccharide chains of N- and O-linked glycoproteins.

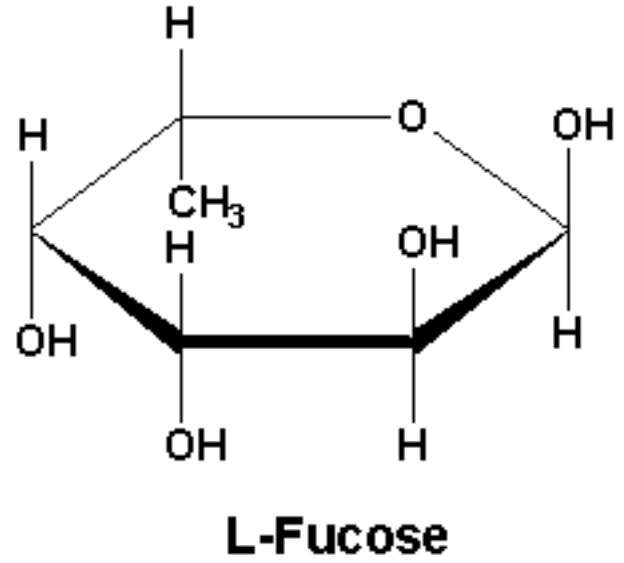

See also: [Biosynthesis of Glycoconjugates](#)

Figure 16.14: Biosynthesis of N-acetylneuraminic acid (sialic acid) from UDP-N-acetylglucosamine.

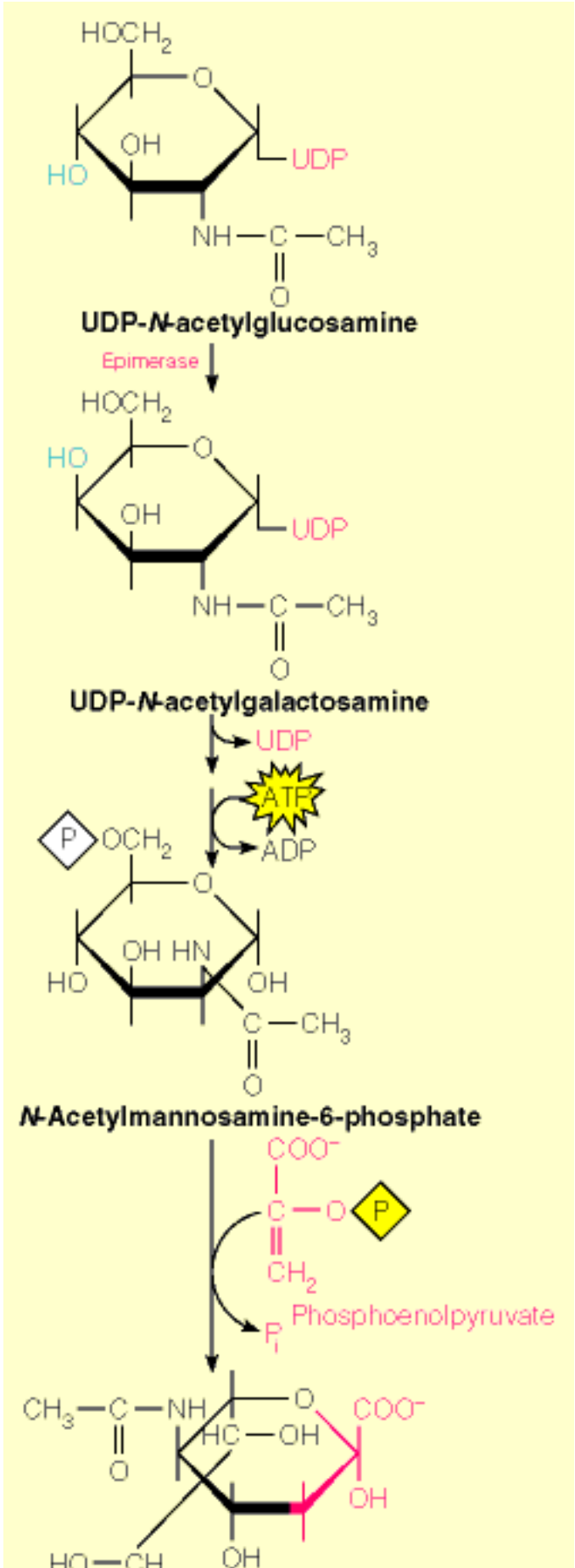

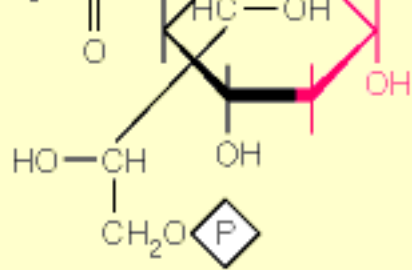

N-Acetylneuraminic acid 9-phosphate

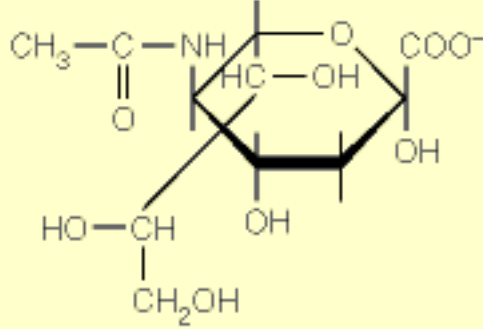
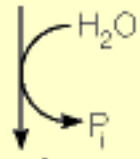

N-Acetylneuraminic acid (sialic acid)

Figure 19.14: Pathways of synthesis of glycosphingolipids.

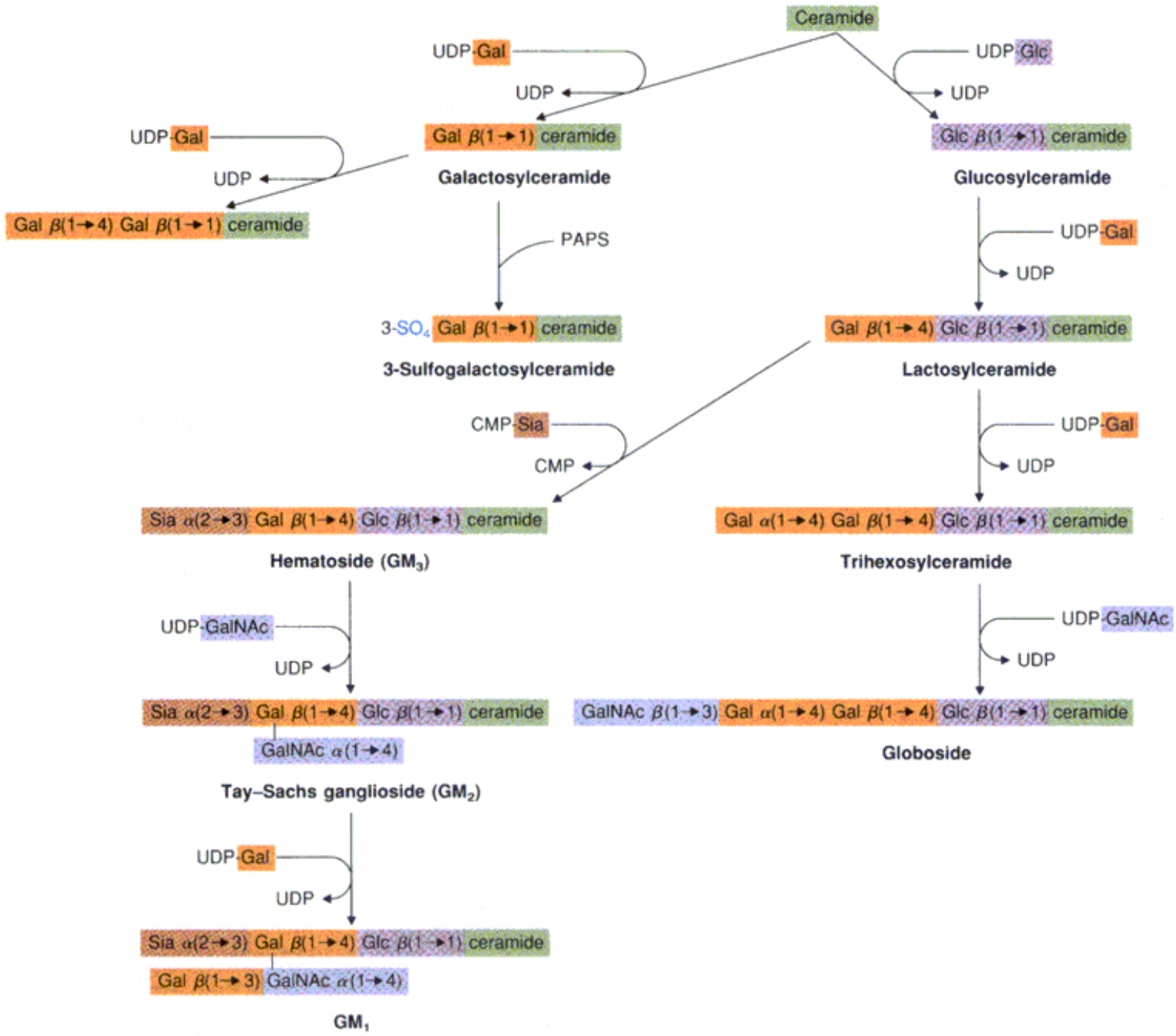

CMP-Sialic Acid

Metabolic activation of sialic acid for oligosaccharide biosynthesis involves formation of **CMP-sialic acid**.

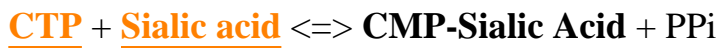
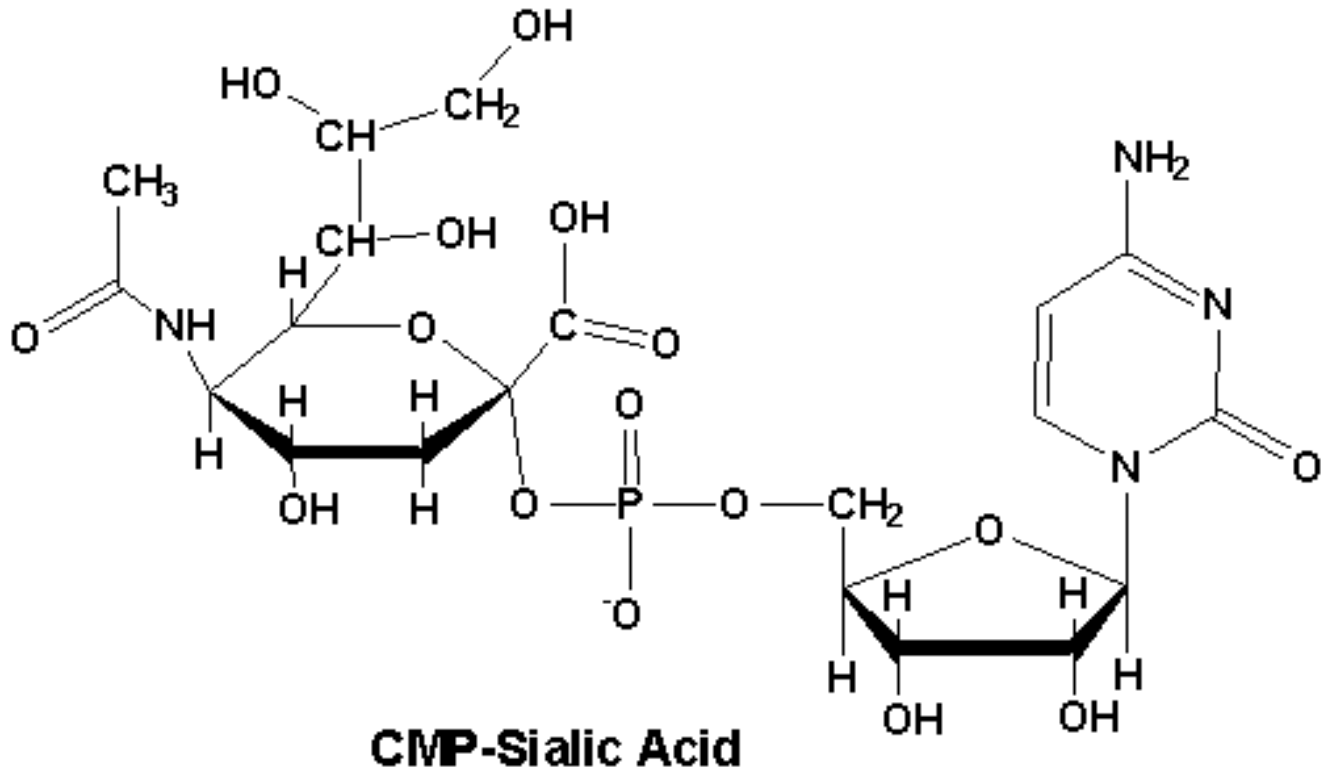

This intermediate is unusual for two reasons. First, other intermediates in oligosaccharide biosynthesis involve nucleoside diphosphates (such as [UDP-Glucose](#)). Second, **CMP-sialic acid** is synthesized in the nucleus of animal cells, whereas all other known nucleotide-linked sugars are synthesized in the cytosol.

See also: [Biosynthesis of Other Polysaccharides](#), [Biosynthesis of Glycoconjugates](#)

Biosynthesis of Other Polysaccharides

Synthesis of other polysaccharides involves many of the same mechanisms as for **glycogen**, particularly the use of nucleotide-linked sugars as activated biosynthetic intermediates and glycosyltransferase enzymes. **Biosynthesis of several polysaccharides** is described briefly below:

Cellulose - a **glucose** homopolymer with $\beta(1\rightarrow4)$ linkages between the units. **UDP-glucose** is used as an intermediate in some plant species. **ADP-glucose** and **CDP-glucose** are used by other plants. ADP-glucose is also the intermediate used in plant starch synthesis and in the synthesis of glycogen in bacterial cells.

Chitin - a structural polysaccharide in the exoskeletons of arthropods and mollusks composed of $\beta(1\rightarrow4)$ linked **N-acetylglucosamine**. The activated intermediate is **UDP-N-acetylglucosamine**.

Hyaluronic Acid - a heteropolymer of alternating units of **glucuronic acid** and **N-acetylglucosamine**. A two enzyme system alternately adds units from **UDP-glucuronate** and **UDP-N-acetylglucosamine** to the growing chain.

Dextran - an $\alpha(1\rightarrow6)$ polymer of glucose with $\alpha(1\rightarrow2)$, $\alpha(1\rightarrow3)$, and $\alpha(1\rightarrow4)$ branch points. **Dextran** is the only polysaccharide listed here that does not use activated nucleotide sugars (or derivatives) in making the polymer. The polymerization, catalyzed by the enzyme dextran sucrose, is a transglycosylation of sucrose:

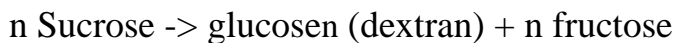

Dextran is made by several bacteria growing in the human mouth and contributes to dental plaque.

See also: **Sucrose**, **Fructose**

ADP-Glucose

ADP-Glucose is an intermediate in cellulose and starch synthesis in some plants and in glycogen in some bacteria.

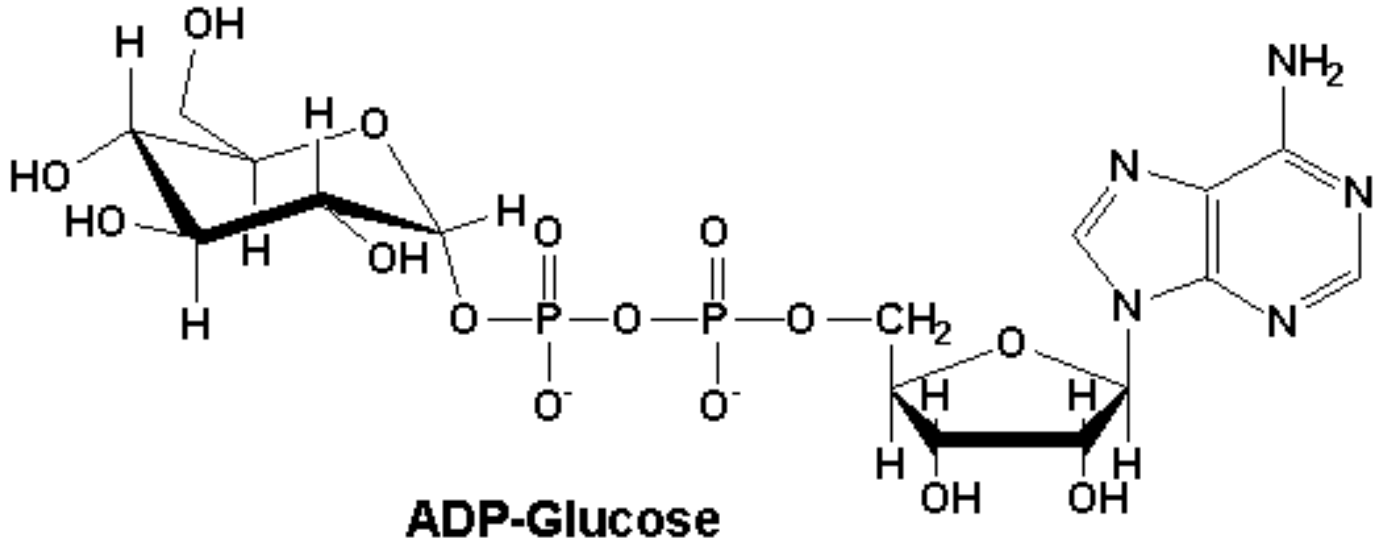

See also: [Cellulose](#), [Starch](#), [Glycogen](#), [UDP-Glucose](#)

CDP-Glucose

CDP-

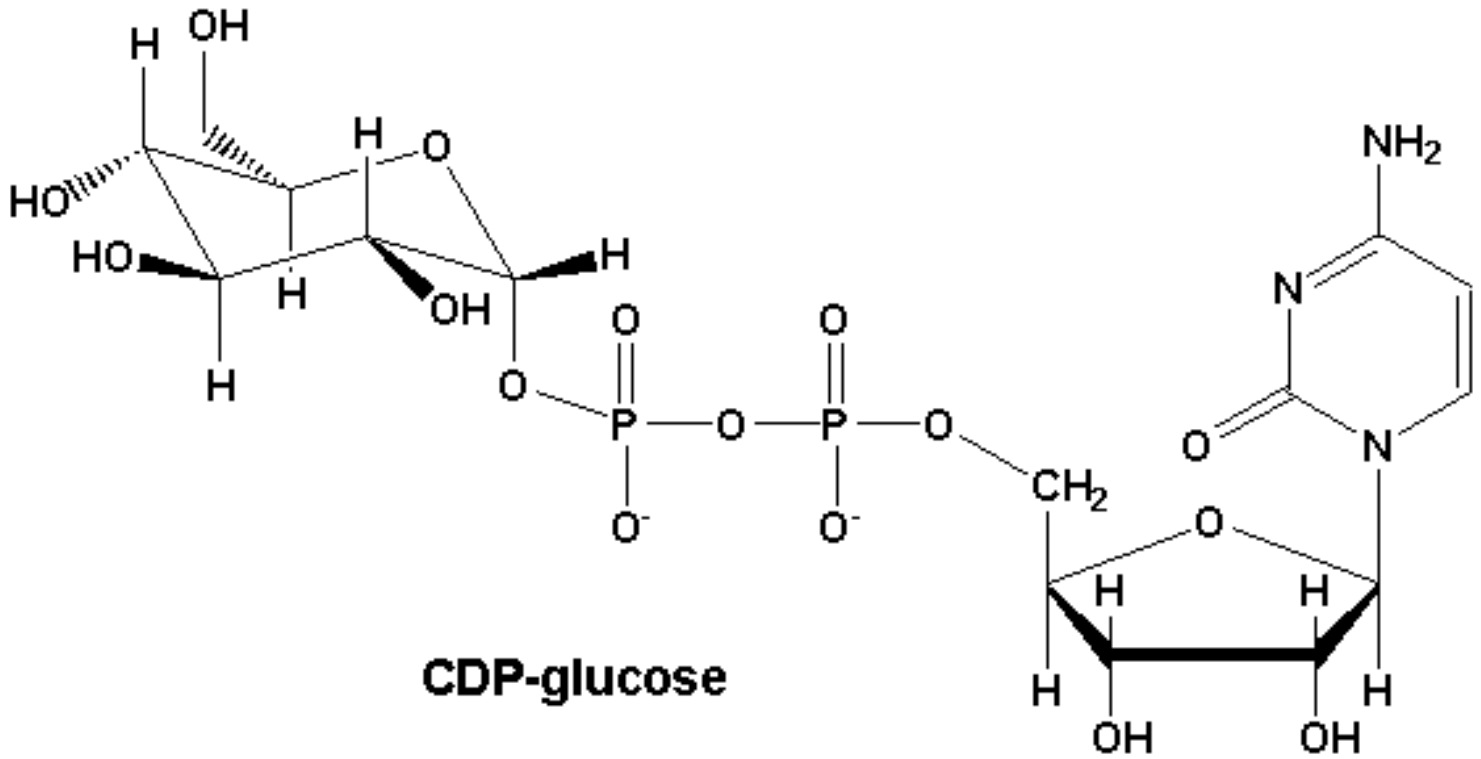

glucose and [ADP-glucose](#) are intermediates of [cellulose](#) synthesis in some plants.

See also: [Biosynthesis of Other Polysaccharides](#)

UDP-Glucuronate

UDP-Glucuronate is an activated form of **glucuronic acid** which donates the glucuronic acid in reactions, such as **glycosaminoglycan** synthesis and catabolism of **heme** compounds (see [here](#))

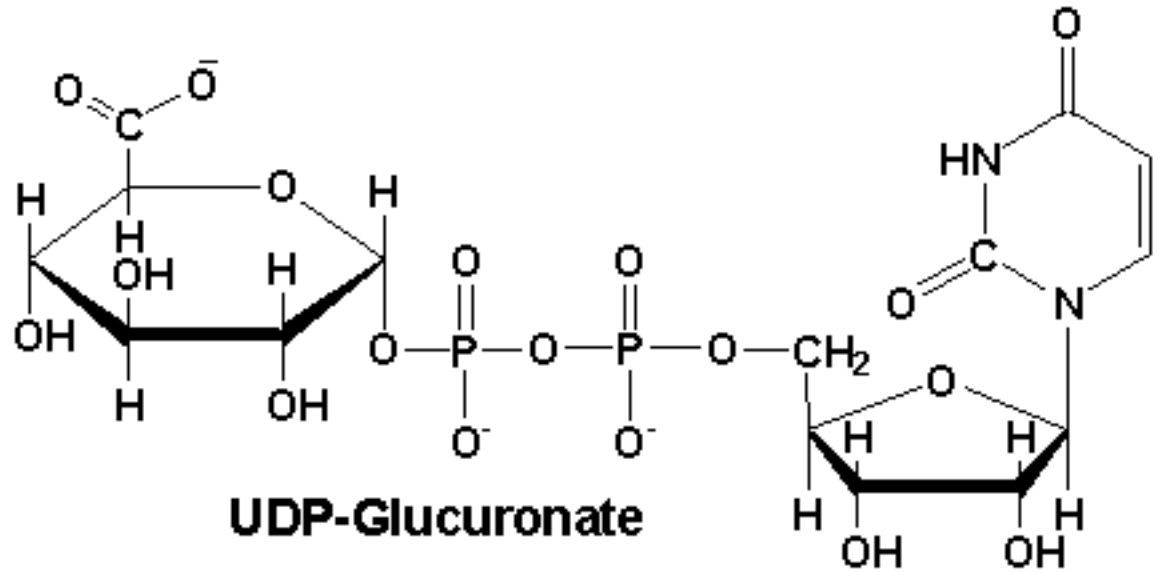

See also: [Figure 9.24b](#), [Polysaccharides](#)

δ -Aminolevulinic Acid (ALA)

δ -Aminolevulinic acid (ALA) is a common intermediate in the biosynthetic pathways of [heme](#), [chlorophylls](#), phycobilins, and cobalamins. Relationships between the various pathways are shown in [Figure 21.27](#).

In animals, all of the nitrogens of heme are derived from [glycine](#) and all of the carbons are derived from [succinate](#) and glycine. The pathway is also called the succinate-glycine pathway. The first step in the process is catalyzed by a [pyridoxal phosphate](#)-containing enzyme, [\$\delta\$ -aminolevulinic acid synthetase](#) (ALA synthetase) ([Figure 21.28](#)).

In plants, ALA is made in a process that begins with [glutamate](#), which becomes linked to a tRNA ([Figure 21.29](#)). In plants, synthesis of ALA is regulated by light.

See also: [Porphyrin and Heme Metabolism](#)

INTERNET LINKS:

1. [Porphyrin and Chlorophyll Metabolism](#)
 2. [Photosynthetic Pigments](#)
-

Figure 21.27: Biosynthetic pathways to tetrapyrroles.

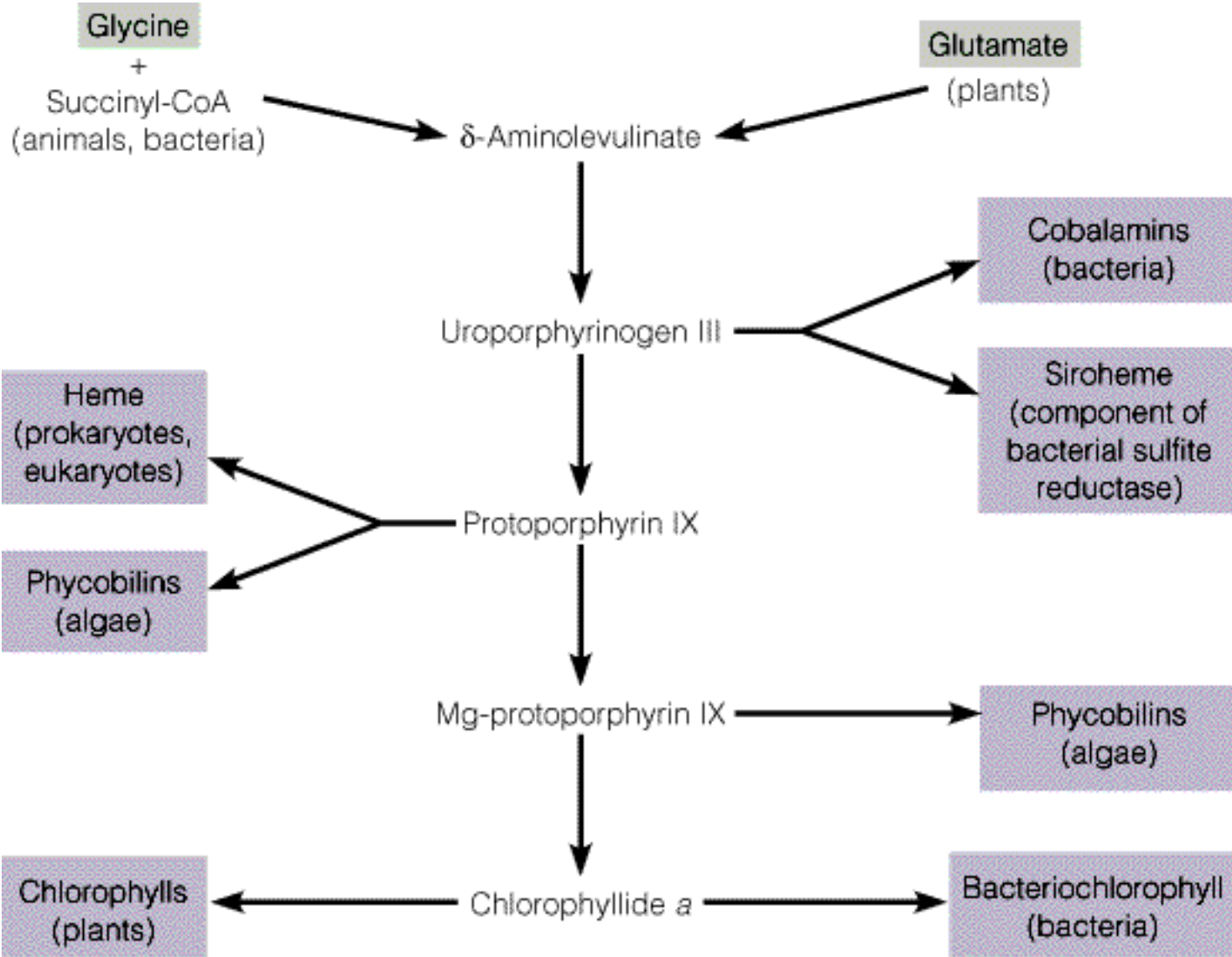

δ Aminolevulinic Acid Synthetase (ALA Synthetase)

The first step making porphyrins is synthesis of δ -[aminolevulinic acid \(ALA\)](#) catalyzed by the pyridoxal phosphate-containing enzyme, δ -[aminolevulinic acid synthetase \(ALA synthetase\)](#) ([Figure 21.28](#)). In plants, ALA is made in a process that begins with [glutamate](#), which becomes linked to a tRNA ([Figure 21.29](#)). In plants, synthesis of ALA is regulated by light.

See also: [Pyridoxal Phosphate](#), [Porphyrin and Heme Metabolism](#)

INTERNET LINKS:

1. [Porphyrin and Chlorophyll Metabolism](#)
 2. [Photosynthetic Pigments](#)
-

Figure 21.28: The δ -aminolevulinic acid synthetase reaction.

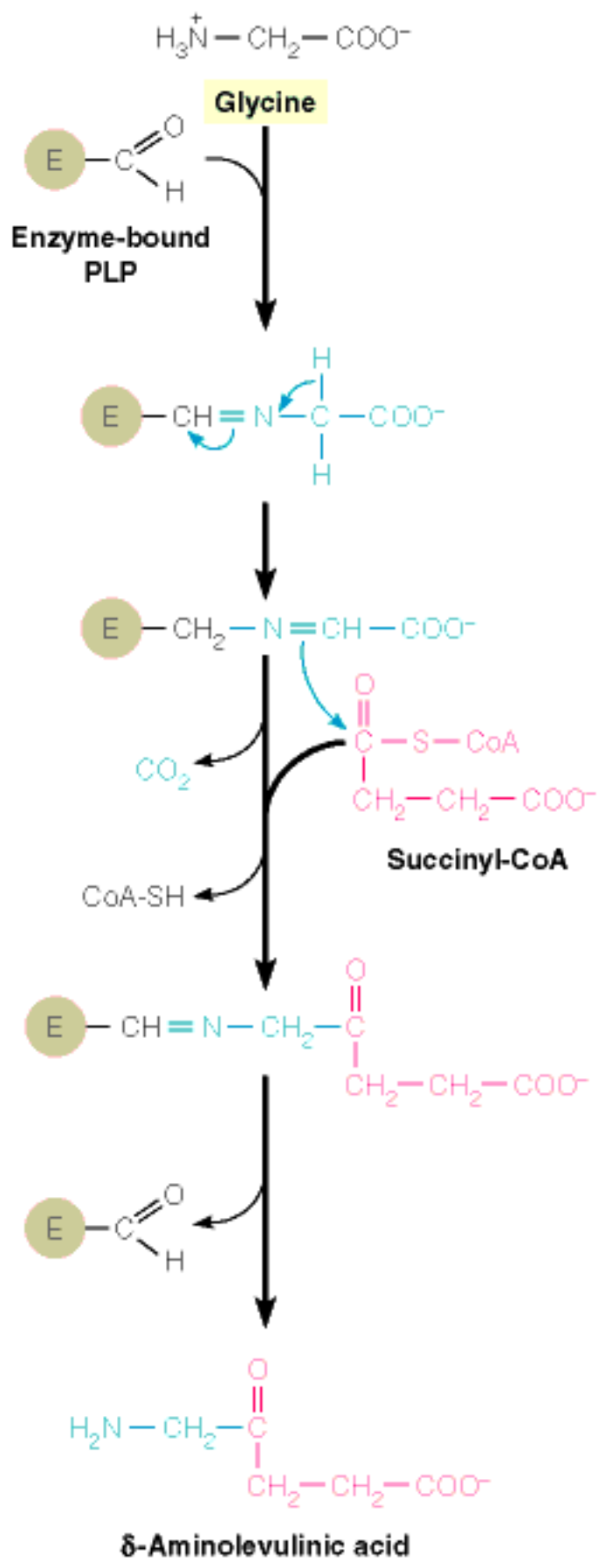
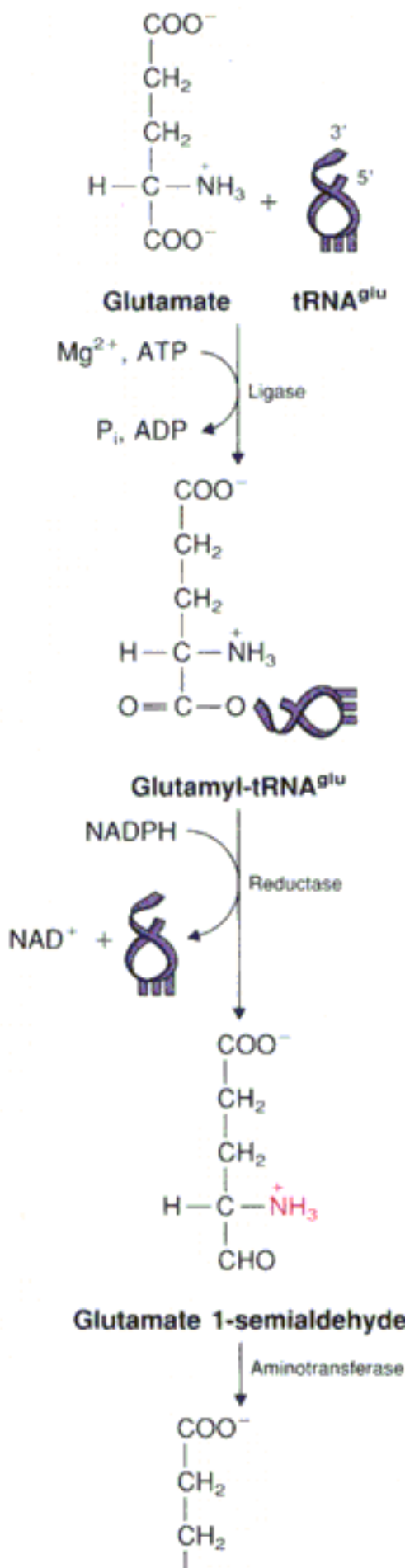
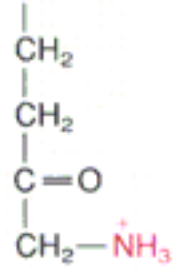

Figure 21.29: Synthesis of δ -aminolevulinic acid in plants.





ALA

Porphobilinogen

Porphobilinogen is an intermediate in [heme](#) biosynthesis (see [here](#)). **Porphobilinogen** is made by condensing two [\$\delta\$ -aminolevulinic acid](#) (ALA) molecules. Subsequently, four porphobilinogen molecules condense to yield a porphyrinogen called uroporphyrinogen ([Figure 21.30](#)).

See also: [Porphyrin and Heme Metabolism](#), [ALA](#), [Porphyrinogen](#), [Uroporphyrinogen III](#)

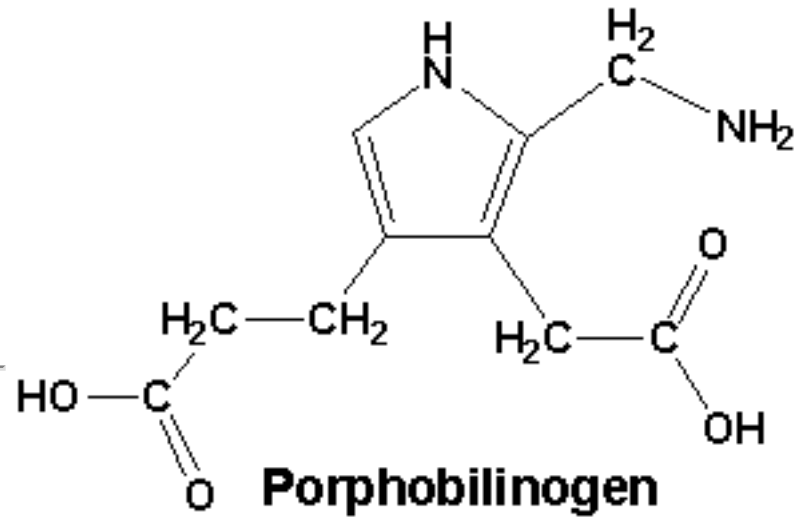

INTERNET LINKS:

1. [Porphyrin and Chlorophyll Metabolism](#)
 2. [Photosynthetic Pigments](#)
-

Unnumbered Item

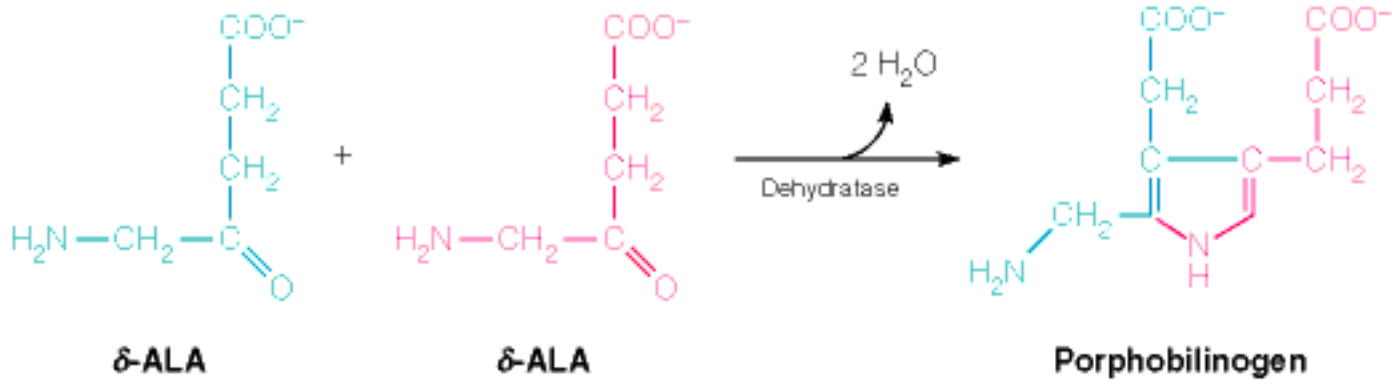
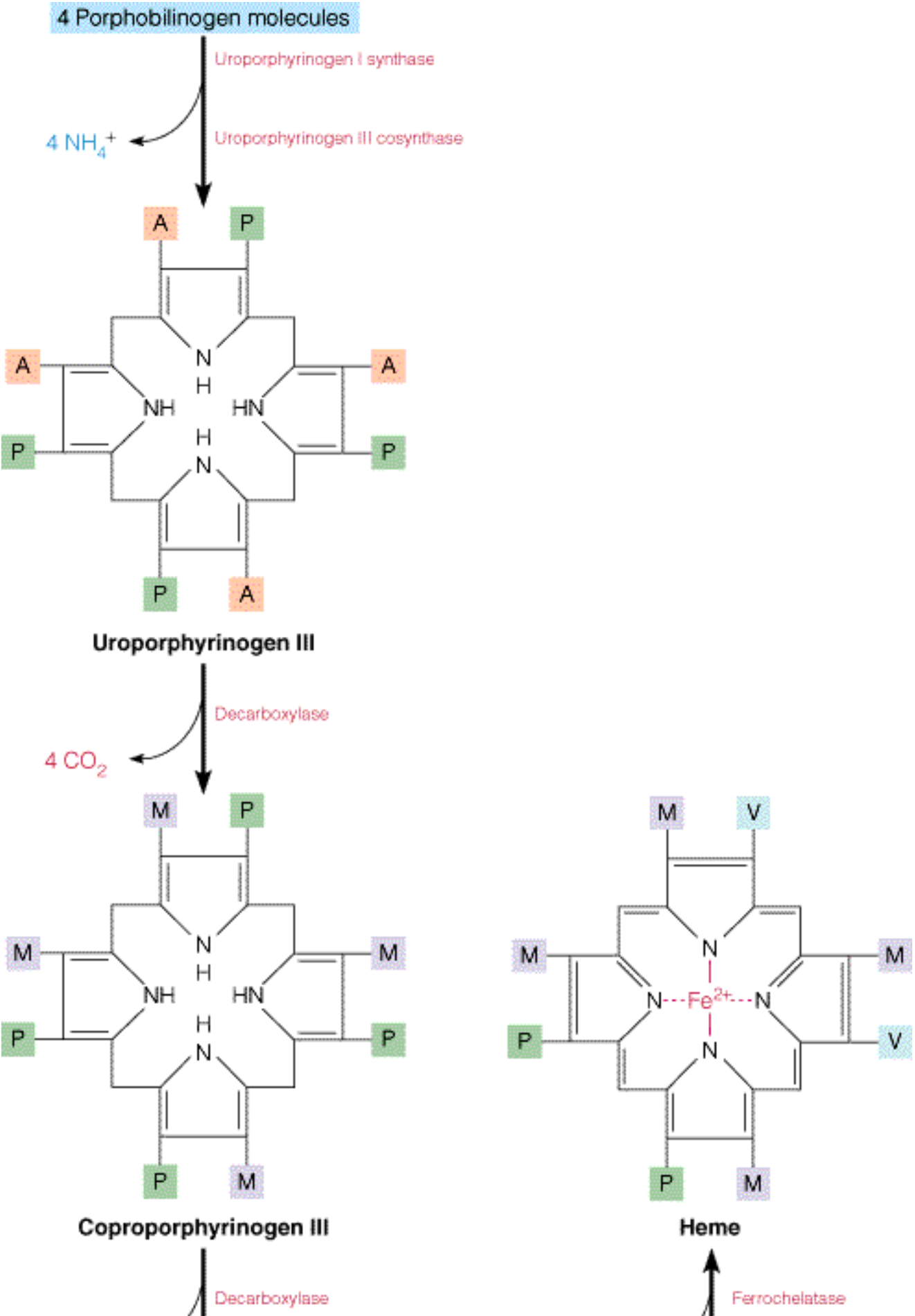
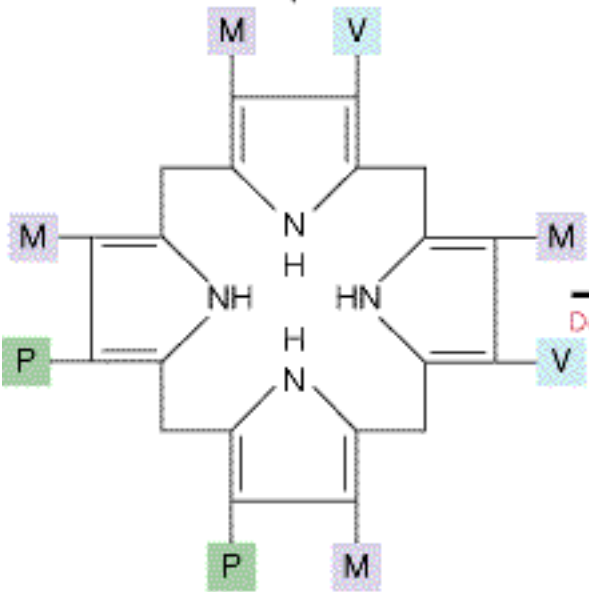
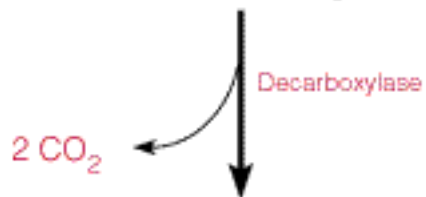

Figure 21.30: Biosynthesis of heme from porphobilinogen.



Coproporphyrinogen III



Protoporphyrinogen IX

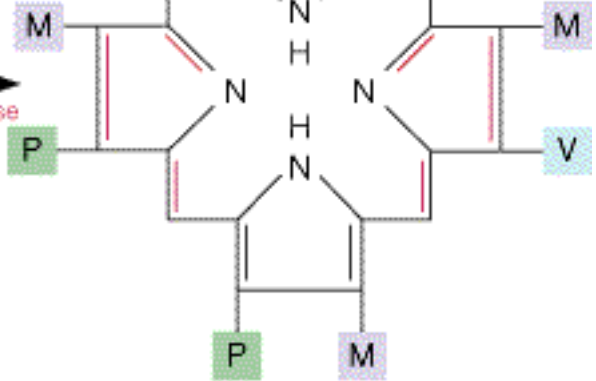

Protoporphyrin IX

Heme

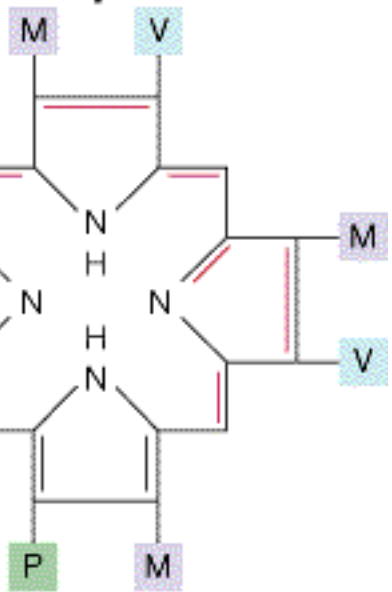

Heme

Porphyrinogen

Porphyrinogens are a class of molecules in porphyrin biosynthesis that contain four **porphobilinogen** molecules. Examples of **porphyrinogens** include **uroporphyrinogen III**, coproporphyrinogen III, and protoporphyrinogen IX (**Figure 21.30**).

See also: , [Porphyrin and Heme Metabolism](#)

INTERNET LINKS:

1. [Porphyrin and Chlorophyll Metabolism](#)
 2. [Photosynthetic Pigments](#)
-

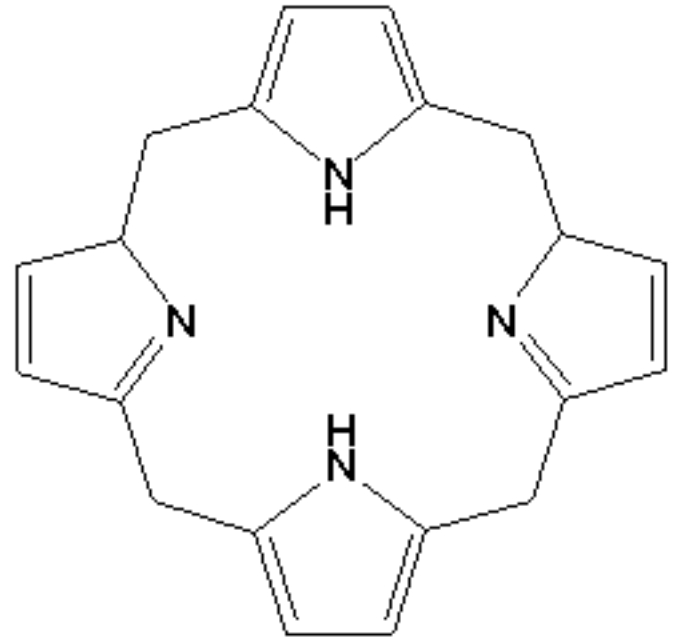

Porphyrinogen

Uroporphyrinogen III

In **heme** biosynthesis, joining of four **porphobilinogen** molecules creates a uroporphyrinogen molecule. There are two possible forms the uroporphyrinogen can have.

Uroporphyrinogen III is an asymmetric compound. It arises from action of uroporphyrinogen I synthase AND uroporphyrinogen III cosynthase. If only the first enzyme is active, the symmetric compound, **uroporphyrinogen I** is produced instead. In the hereditary condition called congenital erythropoietic porphyria, the uroporphyrinogen III cosynthase is defective and the symmetric type I porphyrins accumulate, causing the urine to turn red, the skin to become photosensitive, and the teeth to become fluorescent. Since insufficient heme is produced, anemia results.

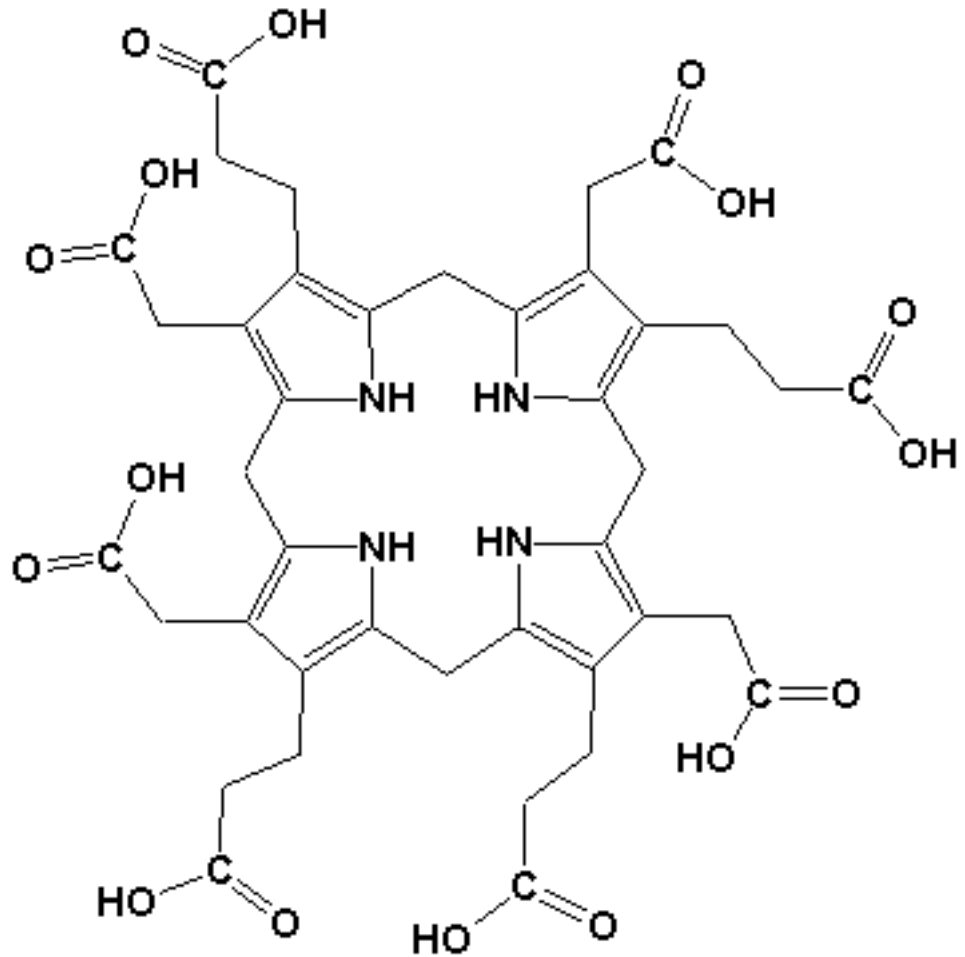

Uroporphyrinogen III

See also: [Porphyrin and Heme Metabolism](#),

INTERNET LINKS:

1. [Porphyrin and Chlorophyll Metabolism](#)
 2. [Photosynthetic Pigments](#)
-

Uroporphyrinogen I

In **heme** biosynthesis, joining of four **porphobilinogen** molecules creates a uroporphyrinogen molecule. There are two possible forms the uroporphyrinogen can have. Uroporphyrinogen III is an asymmetric compound. It arises from action of uroporphyrinogen I synthase AND uroporphyrinogen III cosynthase. If only the first enzyme is active, the symmetric compound, **uroporphyrinogen I** is produced instead. In the hereditary condition called congenital erythropoietic porphyria, the uroporphyrinogen III cosynthase is defective and the symmetric type I porphyrins accumulate, causing the urine to turn red, the skin to become photosensitive, and the teeth to become fluorescent. Since insufficient heme is produced, anemia results.

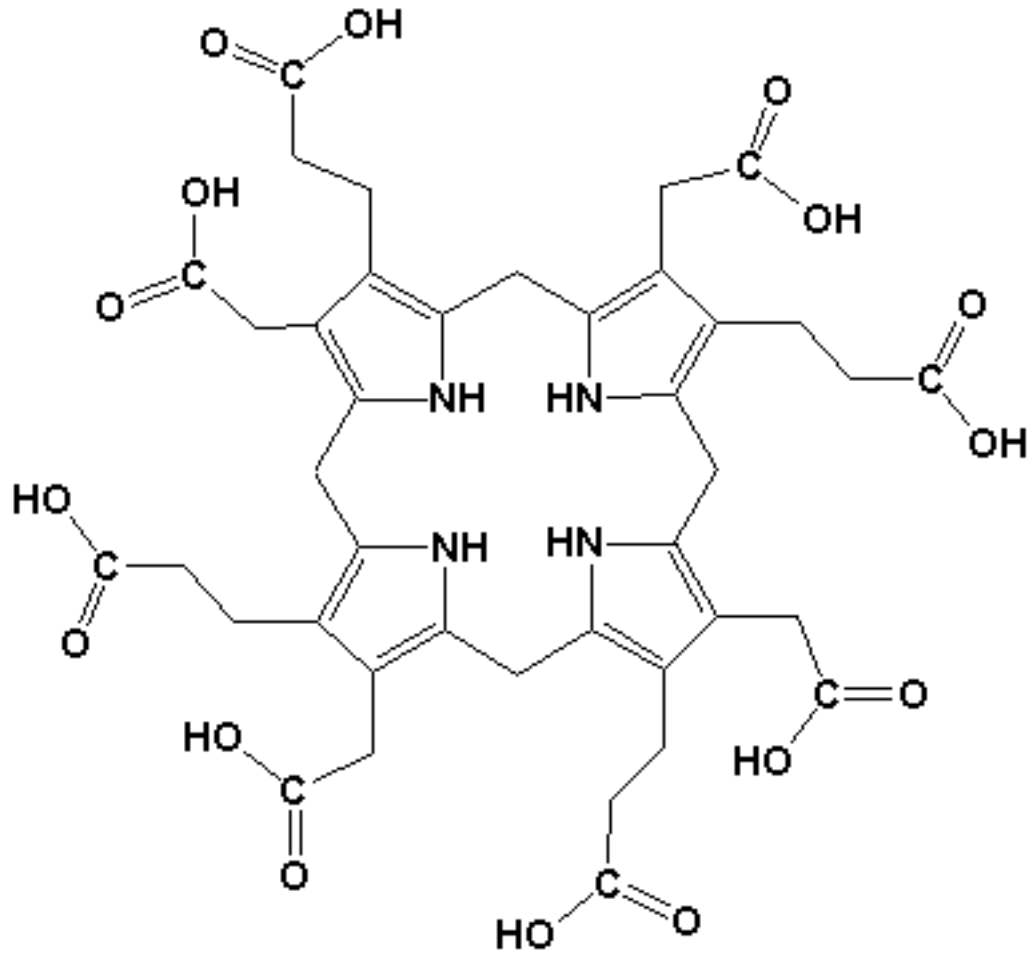

Uroporphyrinogen I

See also: [Porphyrin and Heme Metabolism](#),

INTERNET LINKS:

1. [Porphyrin and Chlorophyll Metabolism](#)
 2. [Photosynthetic Pigments](#)
-

Albumin



Albumin is the most abundant plasma protein, about 50% of the total plasma protein in humans. The protein, with an Mr of 66,200, contains 17 disulfide bridges.

Albumin carries free fatty acids through the bloodstream. Each molecule of **albumin** can bind up to 10 molecules of free fatty acid, although the actual amount bound is usually far lower. Fatty acids are released from **albumin** and taken up by tissues largely by passive diffusion, so that fatty acid uptake into cells is driven primarily by concentration ([Figure 18.3](#)).

See also: [Fat Absorption and Transport](#), [FattyAcids](#)

Fat Absorption and Transport

Dietary **fat** is hydrolyzed in the lumen of the small intestine (mostly by pancreatic lipase) to yield glycerol, free fatty acids, monoacylglycerols, and diacylglycerols. The hydrolysis products of this digestion are combined back into triacylglycerols (**fats**) in the endoplasmic reticula and Golgi complexes of the intestinal mucosa cells. **Fats** are combined with apoproteins to form chylomicrons, which transport the **fats** through blood and lymph ([Figure 18.3](#)). **Chylomicrons** are thus the transport vehicle for dietary **cholesterol**. Note that **fats** in chylomicrons are digested in capillaries (to produce chylomicron remnants), like the **VLDLs** described below. Free fatty acids are rarely found in the bloodstream. Rather, they are complexed to serum **albumin**.

The liver also plays an important role in fat metabolism. **Fats** synthesized in the liver are combined with another set of apoproteins to form very low density lipoproteins (VLDLs), which are hydrolyzed en route to peripheral tissues at the inner surface of capillaries.

Hydrolysis of **fats** in capillaries by lipoprotein lipase yields intermediate-density lipoproteins (**IDLs**) from VLDLs and chylomicron remnants from chylomicrons ([Figure 18.7](#)). IDLs are taken up by the liver and further processed to low-density lipoproteins (LDLs). **LDLs** are the primary form by which cholesterol is transported to tissues and high-density lipoproteins (**HDLs**) serve to transport cholesterol from tissues back to the liver.

See also: [Bile Salts](#), [Pancreatic Lipase](#), [Lipoprotein Lipase](#), [Lipoproteins](#)

INTERNET LINK: [Lipid Transport](#)

Chylomicrons

Chylomicrons are lipoprotein complexes that carry dietary lipids (including [cholesterol](#)) from the lymph through the bloodstream. Lipids in **chylomicrons** are partly removed in the capillaries, yielding chylomicron remnants. Apoproteins making up **chylomicrons** include [Apo A-I](#), [Apo A-II](#), [Apo B-48](#), [Apo C-I](#), [Apo C-II](#), [Apo C-III](#) ([Table 18.1](#)).

See also: [Lipoproteins](#), [Fat Absorption](#), [Apoproteins](#)

INTERNET LINK: [Lipid Transport](#)

Apoprotein A-I (Apo A-I)

Apo A-I is a peptide of molecular weight 28,300 that is a major component of HDLs and is also found in chylomicrons ([Table 18.1](#)). **Apo-I** activates the enzyme, LCAT.

See also: [Table 18.2](#), [Lipoproteins](#), [Apoproteins](#), [HDLs](#), [LCAT](#), [Chylomicrons](#)

INTERNET LINKS:

1. [Lipid Transport](#)
-

Table 18.1



	Chylo- micron	VLDL	IDL	LDL	HDL
Density (g/mL)	<0.95	0.950– 1.006	1.006– 1.019	1.019– 1.063	1.063– 1.210
Components (% dry weight)					
Protein	2	8	15	22	40–55
Triacylglycerol	86	55	31	6	4
Free cholesterol	2	7	7	8	4
Cholesterol esters	3	12	23	42	12–20
Phospholipids	7	18	22	22	25–30
Apoprotein composition	A-I, A-II, B-48, C-I, C-II, C-III	B-100, C-I, C-II, C-III, E	B-100, C-I, C-II, C-III, E	B-100	A-I, A-II, C-I, C-II, C-III, D, E

Sources: Data from D. E. Vance and J. E. Vance (eds.), *Biochemistry of Lipids and Membranes* (Redwood City, Calif.: Benjamin/Cummings, 1985); and J. F. Mead, R. B. Alfin-Slater, D. R. Howton, and G. Popják, *Lipids* (New York: Plenum, 1986).

Table 18.2

Apoprotein	Molecular Weight	Characteristics
A-I	28,300	Major protein in HDL; activates LCAT
A-II	17,400	Major protein in HDL
B-48	241,000	Found exclusively in chylomicrons
B-100	513,000	Major protein in LDL
C-I	7,000	Found in chylomicrons; activates LCAT and LPL
C-II	10,000	Found primarily in VLDL; activates LPL
C-III	9,300	Found primarily in chylomicrons, VLDL, and HDL; inhibits LPL
D	35,000	HDL protein, also called cholesterol ester transfer protein
E	33,000	Found in VLDL, LDL, and HDL

Sources: Data from D. E. Vance and J. E. Vance, eds., *Biochemistry of Lipids and Membranes* (Redwood City, Calif.: Benjamin/Cummings, 1985), and J. F. Mead, R. B. Alfin-Slater, D. R. Howton, and G. Popják, *Lipids* (New York: Plenum, 1986).

Note: LCAT = lecithin:cholesterol acyltransferase, LPL = lipoprotein lipase.

Lipoprotein Complexes

Lipoproteins complexes are soluble aggregates of lipids and proteins that transport lipids through the blood and lymph. Despite their differences in lipid and protein composition, all **lipoproteins** share common structural features, notably a spherical shape that can be detected by electron microscopy. The **lipoproteins** help maintain in solubilized form some 500 mg of total lipid per 100 mL of human blood in the postabsorptive state, after the contents of a meal have been digested and absorbed into the bloodstream.

See also: [Chylomicrons](#), [HDL](#), [LDL](#), [IDL](#), [VLDL](#), [Table 18.1](#), [Table 18.2](#), [Lipoprotein Lipase](#), [Apoproteins](#), [Figures 18.5](#), [18.6](#), [18.7](#), [18.10](#)

INTERNET LINK: [Lipid Transport](#)

High Density Lipoprotein Complexes (HDLs)

HDLs are lipoprotein complexes often referred to as the "good cholesterol" because they function to take cholesterol from peripheral tissues back to the liver and help lower total serum cholesterol ([Figure 18.7](#)). At the liver, **HDLs** are not taken up by endocytosis. Rather, **HDLs** appear to "dock" at a cell surface receptor, deposit cholesterol, and then depart as remnants without being incorporated to the cell's interior.

HDLs contain the apoproteins listed below:

[Apo A-I](#), [Apo A-II](#), [Apo C-I](#), [Apo C-II](#), [Apo C-III](#), [Apo D](#), [Apo E](#)

See also: [Lipoproteins](#), [Cholesterol](#)

INTERNET LINK: [Lipid Transport](#)

Figure 18.7: Overview of lipoprotein transport pathways and fates.

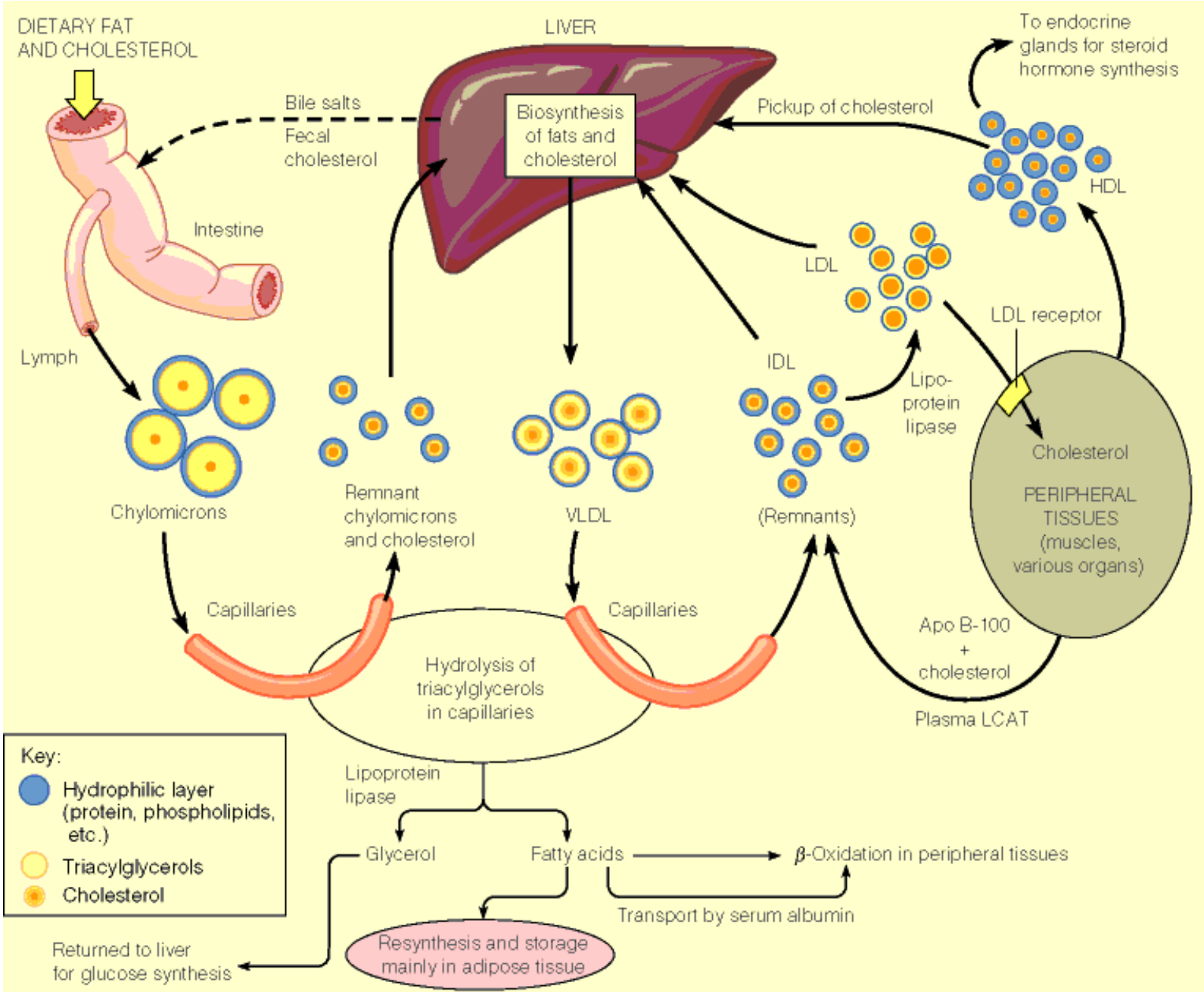

Apoprotein A-II (Apo A-II)

Apo A-II is a polypeptide of molecular weight 17,400 that is a major component of HDLs and is also found in chylomicrons ([Table 18.1](#)).

See also: [Table 18.2](#), [Lipoproteins](#), [Apoproteins](#), [Chylomicrons](#), [HDLs](#)

INTERNET LINK: [Lipid Transport](#)

Apoproteins (Apolipoproteins)

The polypeptide chains of lipoprotein complexes are referred to as **apoproteins**. For example, HDLs, VLDLs, IDLs, LDLs, and chylomicrons are all lipoprotein complexes, but the polypeptide chains within them, such as Apo A-I, Apo B-100, or Apo E, are all **apoproteins**.

The **apoproteins** of the lipoprotein complexes are shown below:

[Apo A-I](#)

[Apo A-II](#)

[Apo B-100](#)

[Apo B-48](#)

[Apo C-I](#)

[Apo C-II](#)

[Apo C-III](#)

[Apo D](#)

[Apo E](#)

See also: [Lipoprotein Complexes](#), [HDLs](#), [VLDLs](#), [IDLs](#), [LDLs](#), [Chylomicrons](#), [Apo A-I](#), [Apo B-100](#), [Apo E](#)

INTERNET LINK: [Lipid Transport](#)

Apoprotein B-100 (Apo B-100)

Apo B-100 is the major protein found in LDLs and a lesser constituent of IDLs and VLDLs ([Table 18.1](#)). It has a molecular weight of 513,000. The apoprotein B-48, which is found in chylomicrons, is a product of the same gene as **Apo B-100** and contains identical amino acid sequence to the N-terminal half of **Apo B-100**. **Apo B-100** is involved in binding lipoprotein complexes to the LDL receptor.

See also: [Table 18.2](#), [Lipoproteins](#), [Apoproteins](#), [LDLs](#), [IDLs](#), [VLDLs](#), [Apoprotein B-48](#), [Chylomicrons](#), [LDL Receptor](#)

INTERNET LINK: [Lipid Transport](#)

Low Density Lipoprotein Complexes (LDLs)

LDLs are lipoprotein complexes referred to as "bad cholesterol" because prolonged elevation of **LDL** levels leads to atherosclerosis. **LDLs** are the primary transport vehicle for **cholesterol** synthesized in the liver (See **Figure 18.7**). Oxidation of **LDLs** leads to foam cell formation and ultimately an atherosclerotic plaque. The primary apoprotein contained in **LDLs** is **Apo B-100**.

LDLs transport cholesterol into target cells by binding to an LDL receptor and being absorbed into the cell by a process referred to as **receptor-mediated endocytosis**. People with the hereditary disease familial hypercholesterolemia have elevated serum cholesterol levels arising from problems with their **LDL Receptors**.

See also: **Lipoproteins**, **Table 18.1**, **Familial Hypercholesterolemia**, **Atherogenesis**, **Coated Pits**

INTERNET LINK: **Lipid Transport**

Receptor-Mediated Endocytosis

Cholesterol synthesized in the liver is transported to peripheral cells via low-density lipoproteins (**LDLs**) (**Figure 18.7**). LDLs are taken up by the cells in the process called **receptor-mediated endocytosis**. This process involves binding of the LDL to the LDL receptors, located in coated pits, followed by engulfment of the LDL. Several of these engulfed vesicles come together in the cell to form an endosome (**Figure 18.10**), which fuses with a lysosome to digest the contents.

Receptor-mediated endocytosis is now known to be a widely used pathway for internalization of extracellular substances, including other lipoproteins, cell growth factors, and some viruses.

See also: [LDL Receptors](#), [Coated Pits](#), [Lipoprotein Complexes](#)

Figure 18.10: Involvement of LDL receptors in cholesterol uptake and metabolism.

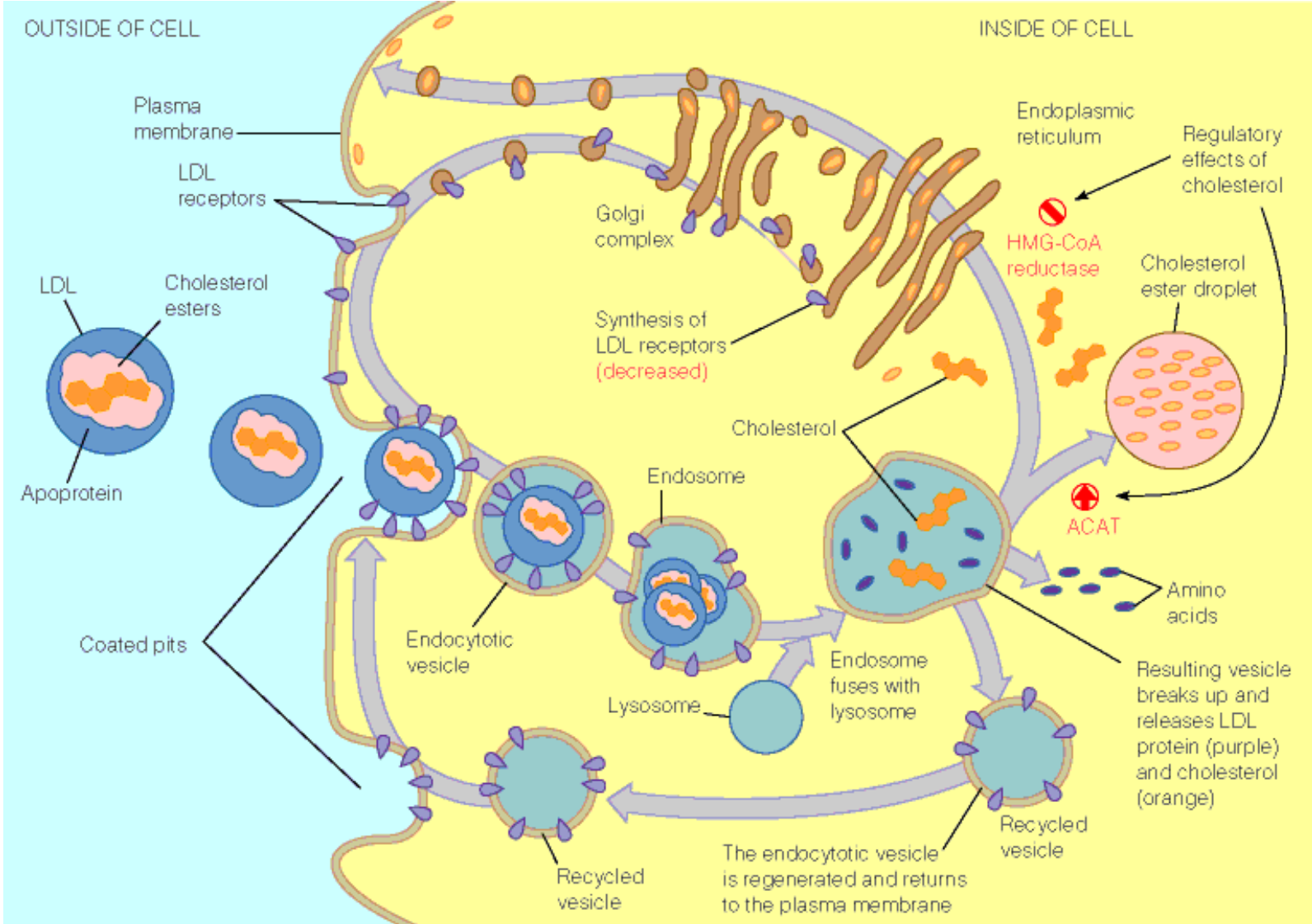

LDL Receptor

The LDL lipoprotein complexes bind to receptor cells at specialized sites called **LDL receptors**. The receptors are clustered in structures called coated pits, which are abundant in the protein called clathrin. After binding to the **LDL receptor**, the LDL is internalized into the target cell by a process called receptor mediated endocytosis ([Figure 18.10](#)).

People with the hereditary disease [familial hypercholesterolemia](#) have elevated serum [cholesterol](#) levels arising from problems with their **LDL receptors**.

See also: [Lipoproteins](#), [Coated Pits](#), [Receptor Mediated Endocytosis](#), [LDLs](#), [Clathrin](#)

Familial Hypercholesterolemia (FH)

Familial Hypercholesterolemia (FH) is a hereditary disease. Individuals with **FH** typically have mutations affecting their **LDL Receptor** (see below). The result of these mutations is a higher than normal level of serum cholesterol. Individuals who are homozygous for the disease have very high levels of **cholesterol** in the blood and usually die of heart disease before age 20. People heterozygous for the disease have higher than normal cholesterol and are at high risk for heart attacks in their thirties and forties.

Cultured fibroblasts from **FH** individuals synthesize cholesterol at abnormally high levels in the presence of LDLs, compared to normal cells. This activity is linked to the enzyme HMG-CoA reductase, the major regulatory enzyme of cholesterol biosynthesis, which is allosterically inactivated by cholesterol. Cells from **FH** individuals have an impaired ability to take up cholesterol, via receptor mediated endocytosis, thus requiring endogenous synthesis. LDL levels in the bloodstream remain high, due to lack of uptake. High LDL levels favor oxidation of the components of the LDL and ultimately formation of atherosclerotic plaques.

Phenotypes of the LDL receptor mutations in **FH** individuals are as follows:

1. Reductions in amount of LDL receptor made;
2. LDL receptor is made, but it fails to migrate to plasma membrane;
3. LDL receptor is in plasma membrane, but it fails to bind LDL; and
4. LDL receptor is in plasma membrane and binds LDL, but it fails to cluster in coated pits.

See also: , [LDL](#), [HMG-CoA Reductase](#), [Receptor Mediated Endocytosis](#), [Coated Pits](#), [Atherogenesis](#), [Lovastatin](#)

INTERNET LINK: [Familial Hypercholesterolemia](#)

HMG-CoA Reductase

HMG-CoA reductase is the most important regulatory enzyme in cholesterol biosynthesis. It catalyzes the reaction:

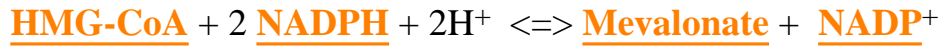

This reaction occurs in the cytoplasm. Mevalonate is converted in a many step process to cholesterol and other steroids. Interestingly, cholesterol is an allosteric inactivator of **HMG-CoA reductase**, so when cells take up cholesterol by receptor mediated endocytosis, endogenous cholesterol synthesis is lessened.

A competing enzyme for HMG-CoA is HMG-CoA lyase, which is found in the cytoplasm.

See also: Cholesterol, Lovastatin,

Coated Pits

Coated pits are receptors in the cell membrane that participate in the process of receptor mediated endocytosis, in which LDLs are taken up by cells. The pits have a cage-like structure arising from the protein **clathrin**, which is their primary protein. The receptor recognizes and binds to **apoprotein B-100** of the LDL. The entire **LDL** is engulfed in the process and taken into the cell (See **Figure 18.10**) to form an endocytic vesicle.

See also: [Receptor Mediated Endocytosis](#), [Cholesterol](#),

Clathrin



Clathrin is the most abundant protein found in coated pits, the site of LDL receptors, which participate in receptor-mediated endocytosis. This process is very important in cholesterol transport in the body.

See also: Cholesterol, Fat Absorption and Transport, Lipoprotein Complexes in Fat Transport

Very Low-Density Lipoproteins (VLDL)



VLDLs are lipoprotein complexes that carry lipids in the bloodstream. **VLDLs** are the precursors of IDLs ([Figure 18.7](#)). **VLDLs** are composed of the following apoproteins:

[Apo B-100](#), [Apo C-I](#), [Apo C-II](#), [Apo C-III](#), [Apo E](#)

See also: [Lipoproteins](#), [Cholesterol](#)

INTERNET LINK: [Lipid Transport](#)

Apoprotein C-I (Apo C-I)

Apo C-1 is a small polypeptide of 7,000 molecular weight found in chylomicrons ([Table 18.1](#)). **Apo C-1** activates LCAT and Lipoprotein Lipase.

See also: [Table 18.2](#), [Lipoproteins](#), [Apoproteins](#), [Chylomicrons](#), [LCAT](#), [Lipoprotein Lipase](#)

INTERNET LINK: [Lipid Transport](#)

Lecithin Cholesterol Acyl Transferase (LCAT)



LCAT catalyzes the reaction:



LCAT is secreted from liver into the bloodstream ([Figure 18.7](#)). Cholesterol esters are less polar forms of cholesterol used for storage.

See also: [Fat Absorption and Transport](#), [Lipoprotein Complexes in Fat Transport](#)

Lysolecithin

Lysolecithin is one of the products of the LCAT-catalyzed reaction in which an acyl group is transferred from **phosphatidylcholine** to cholesterol.

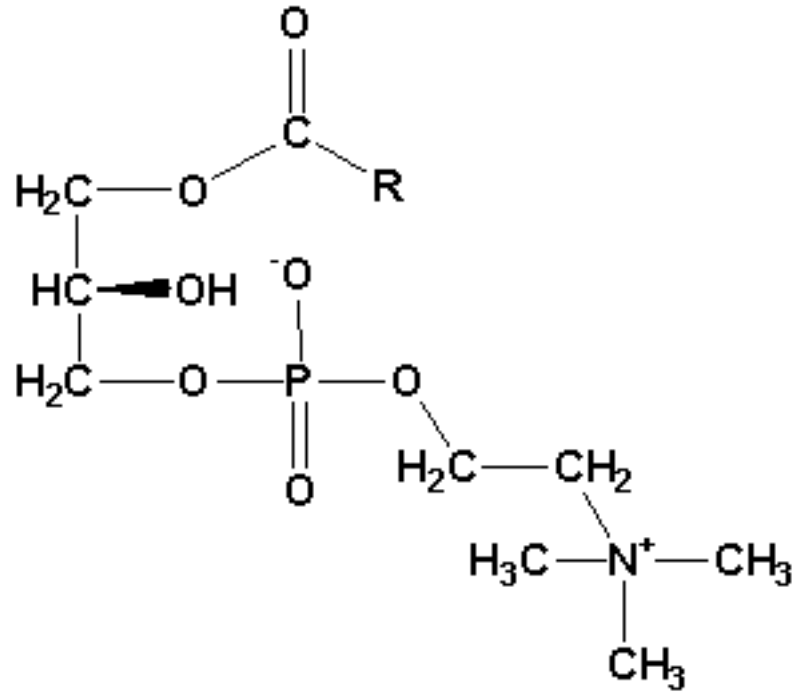

1-Acylglycerophosphorylcholine (lysolecithin)

See also: [LCAT](#), [Cholesterol](#)

Phosphatidylcholine

Phosphatidylcholine is a glycerophospholipid that is involved in the metabolism of several lipid compounds. It is synthesized in the reaction below (see [Figure 19.5](#)):

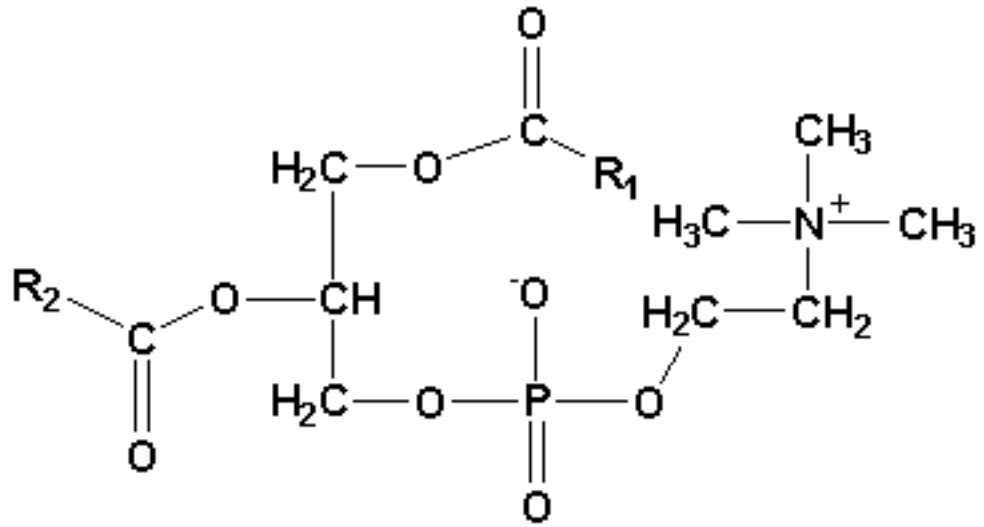
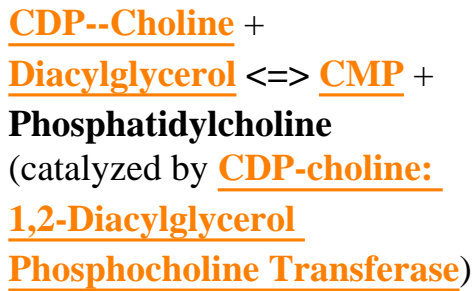

Phosphatidylcholine

Phosphatidylcholine can also be synthesized in the reaction shown [here](#).

The sphingolipid, [sphingomyelin](#), is made by transferring [choline](#) from **phosphatidylcholine** to a [ceramide](#) ([Figure 19.13](#)).

See also: [Glycerophospholipids](#), [Glycerophospholipid Pathway](#), [Prostaglandin Biosynthesis](#)

INTERNET LINKS

1. [Glycerolipid Metabolism](#)
 2. [Phospholipid Catabolism](#)
-

Figure 19.5: Synthesis of phosphatidylcholine from choline.

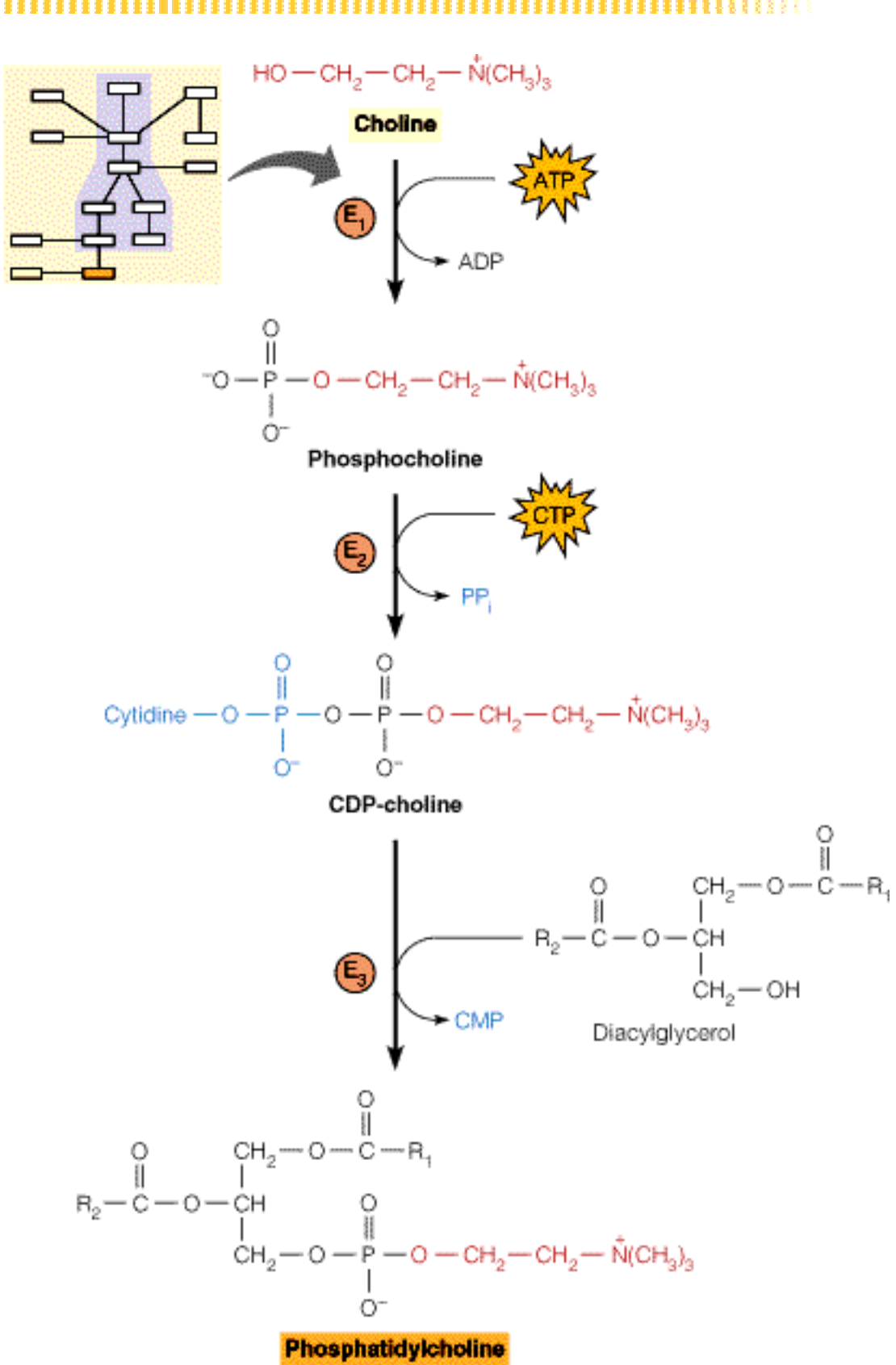

CDP-Choline

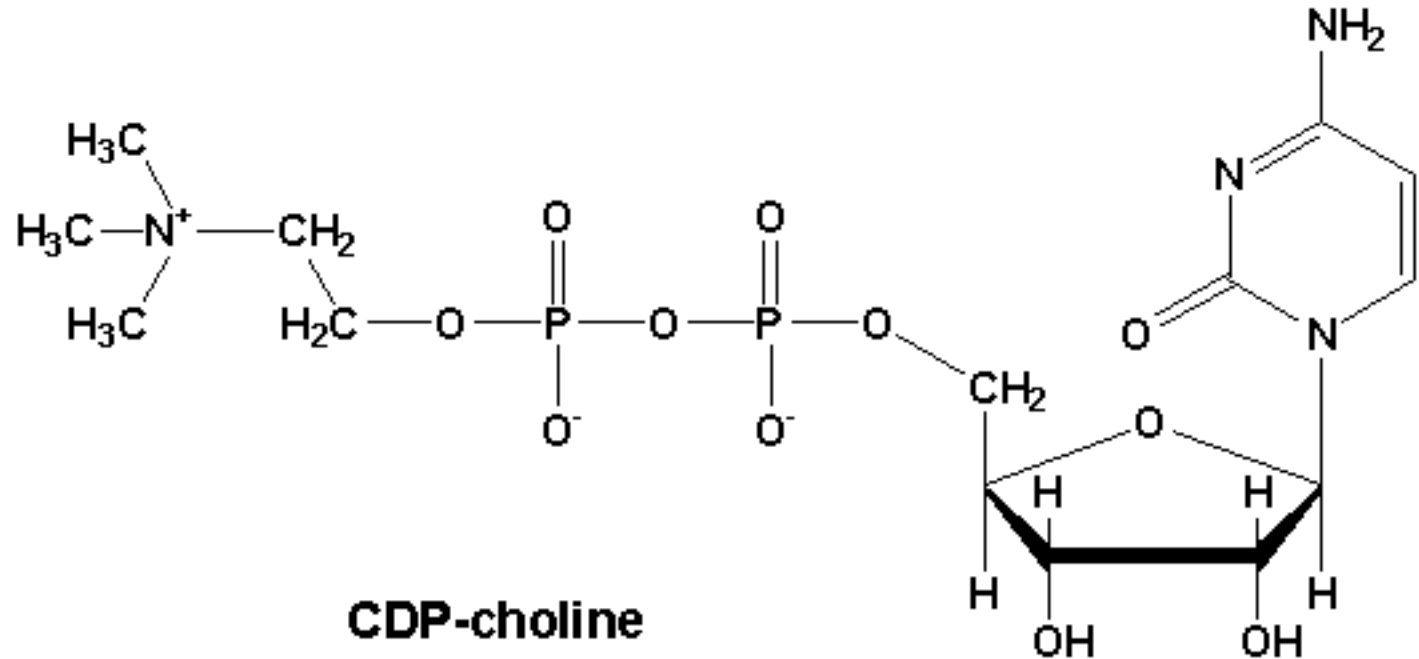

CDP-choline is an intermediate the predominant mechanism of biosynthesis of [phosphatidylcholine](#) ([Figure 19.5](#)).

1. [Phosphocholine](#) + [CTP](#) \rightleftharpoons [CDP-choline](#) + PPi, (catalyzed by CTP:phosphocholine cytidyl transferase)
2. [CDP--choline](#) + [Diacylglycerol](#) \rightleftharpoons [CMP](#) + [Phosphatidylcholine](#) (catalyzed by [CDP-choline: 1,2-Diacylglycerol Phosphocholine Transferase](#))

See also: [Phosphatidylcholine](#), [Glycerophospholipids](#), [Glycerophospholipid Pathway](#), [Glycerophospholipid Metabolism in Eukaryotes](#)

INTERNET LINKS

1. [Glycerolipid Metabolism](#)
 2. [Phospholipid Catabolism](#)
-

Phosphocholine

Phosphocholine is transferred from [phosphatidylcholine](#) to a [ceramide](#) in order to make [sphingomyelin](#).

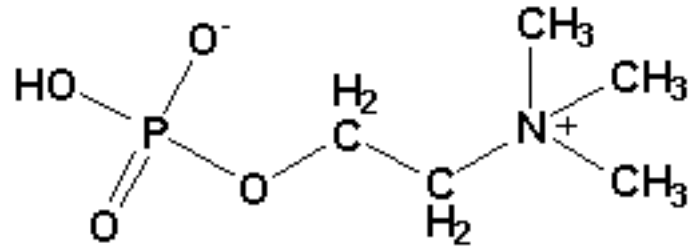

Phosphocholine

Phosphocholine is also an intermediate in synthesis of phosphatidylcholine in animals ([Figure 19.5](#))

Phosphocholine + [CTP](#) \rightleftharpoons [CDP-choline](#) + PPi,

See also: [Phosphatidylcholine](#), [Glycerophospholipids](#), [Glycerophospholipid Pathway](#), [Glycerophospholipid Metabolism in Eukaryotes](#)

INTERNET LINKS

1. [Glycerolipid Metabolism](#)
 2. [Phospholipid Catabolism](#)
-

Ceramides

Ceramides are a group of sphingolipids with the general structure shown as part of sphingomyelin [here](#). **Ceramides** are made either as part of sphingolipid biosynthesis or degradation.

Ceramides are synthesized by attachment of an acyl group to the amino alcohols [sphingosine](#), dihydrosphingosine (see [here](#)), or their derivatives.

[Cerebrosides](#) are made from ceramides by attachment of a sugar group to the **ceramide** moiety ([Figure 19.14](#)).

[Sphingomyelin](#) is made by transferring [choline](#) from [phosphatidylcholine](#) to a **ceramide** ([Figure 19.13](#))

Ceramides are broken down by the enzyme ceramidase. Deficiency of ceramidase leads to accumulation of **ceramides**, which results in deformed joints and problems with heart, lungs, and lymph nodes. The syndrome is usually fatal within a few years of birth.

See also: [Sphinglipids](#), [Table 19.1](#)

Unnumbered Item

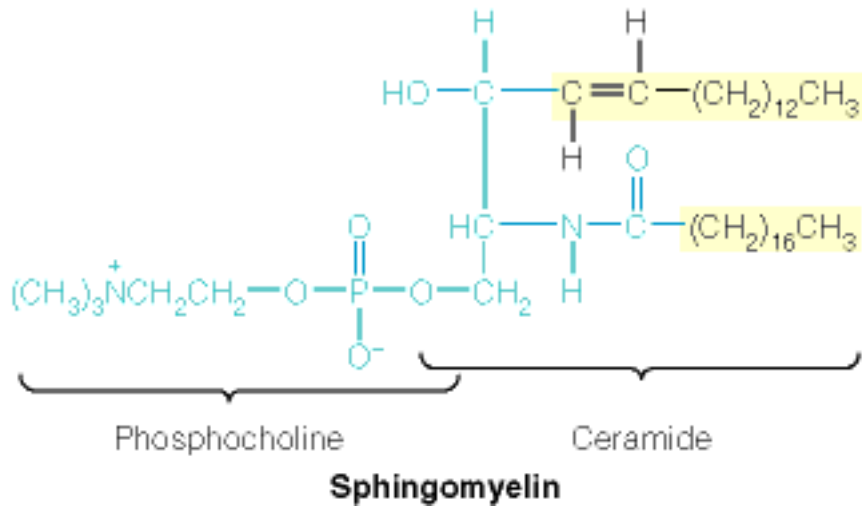

Sphingosine

Sphingolipids all have the a common structure as their foundation resembling **sphingosine**. Acylation of the amine group of **sphingosine** yields a ceramide, which is a precursor of all the other sphingolipids.

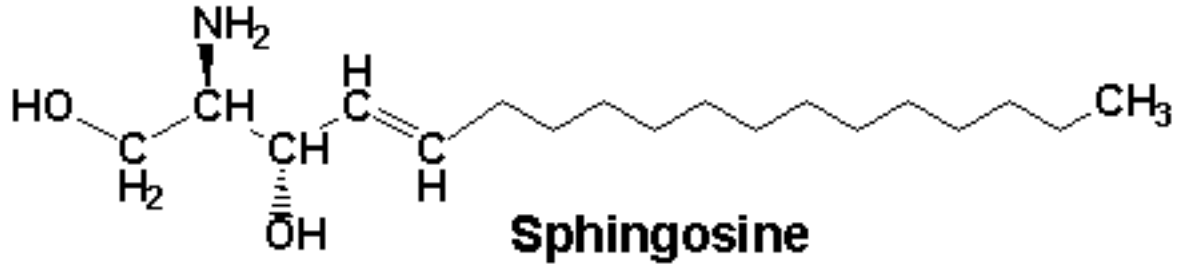

See also: [Sphingolipids](#), [Ceramides](#)

Sphingolipids

Sphingolipids are a class of lipids found in membranes, particularly of nervous tissue. **Sphingolipids** are derived ultimately from palmitoyl-CoA and serine, as shown in the reaction of Figure 19.13.

Ceramides are **sphingolipids** containing two acyl-moieties. The more complex, carbohydrate-containing **sphingolipids**, such as the cerebrosides and the gangliosides, are derived from the ceramides. **Sphingolipids** containing a carbohydrate are called glycosphingolipids.

See also: Palmitic Acid, Sphingosine, Sphingomyelin, Globosides

INTERNET LINKS:

1. Glycosphingolipids
 2. Sphingolipid Metabolism
 3. Sphingoglycolipid Metabolism
-

Figure 19.13: Biosynthesis of sphingolipids.

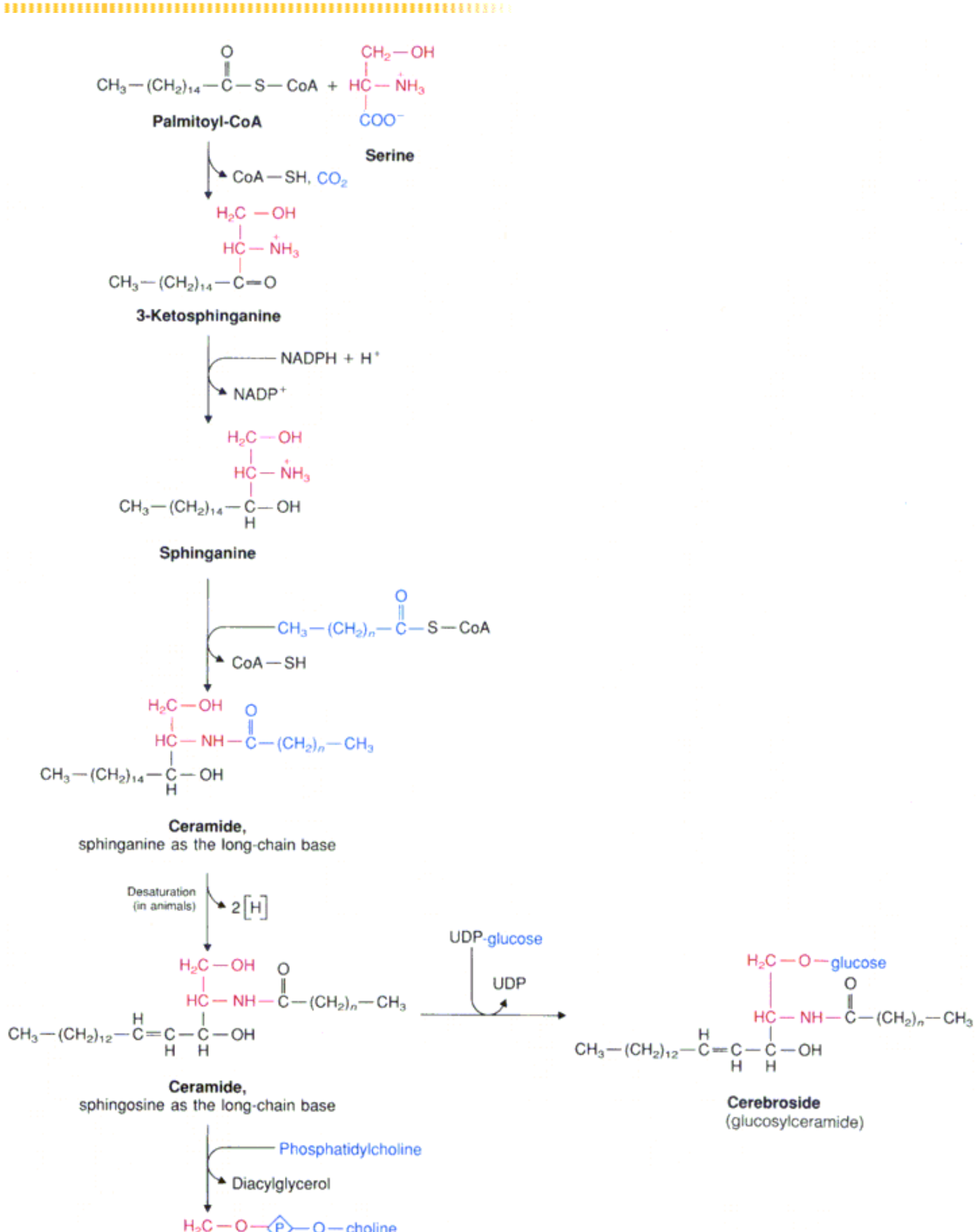

Phosphatidylcholine

Diacylglycerol

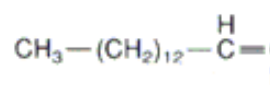
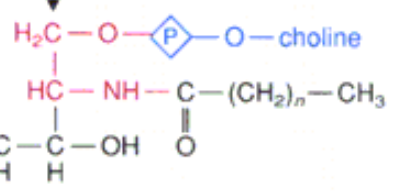

Sphingomyelin

Cerebrosides

Cerebrosides are sphingolipids made by attaching a sugar to a **ceramide** (**Figure 10.8**). **Cerebrosides** are prominent components of membranes, particularly in the brain. Since they contain a sugar, **cerebrosides** are also called glycosphingolipids. **Cerebrosides** are distinguished from gangliosides in that the latter contain at least one sialic acid within them. **Cerebrosides** differ from globosides in that the latter contain multiple sugar moieties, whereas **cerebrosides** only contain one.

The most common **cerebrosides** include galactosylceramide, glucosylceramide, and sulfatides (see **Figure 19.14** for synthesis scheme). Sulfatides are made by transferring a sulfate group to a galactosylceramide (**Figure 19.14**).

Deficiencies in enzymes involved in catabolism of **cerebrosides** lead to sphingolipidosis. These give rise to the following diseases - Gaucher's Disease (deficiency of β -glucosidase - **#4**), Globoid cell leukodystrophy (deficiency of β galactosidase - **#7**), and metachromatic leukodystrophy (deficiency of arylsulfatase A - **#8**). These enzymes are depicted in **Table 19.1** and **Figure 19.16** consistent with the numbers shown in **red** above.

See also: [Sphingolipids](#), [Glycosphingolipids](#), [Gangliosides](#), [Sialic Acid](#), [Globosides](#)

Figure 10.8: Examples of glycosphingolipids.

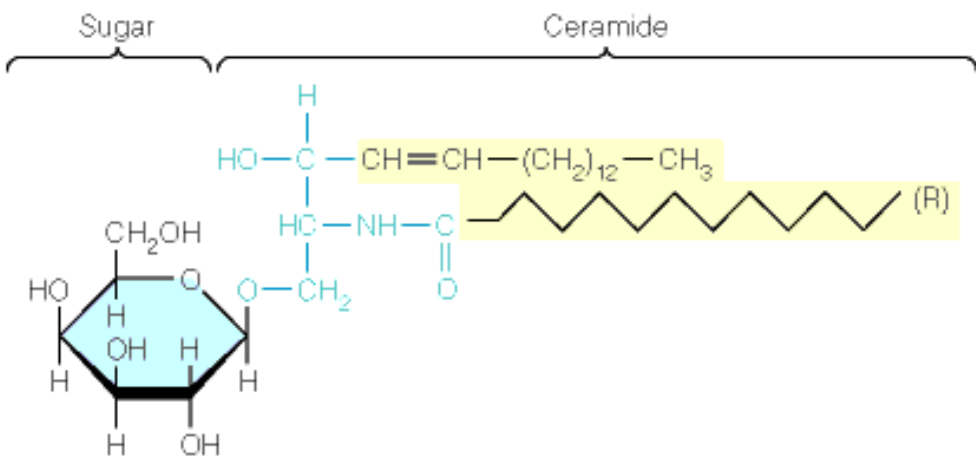

(a) Galactosylceramide

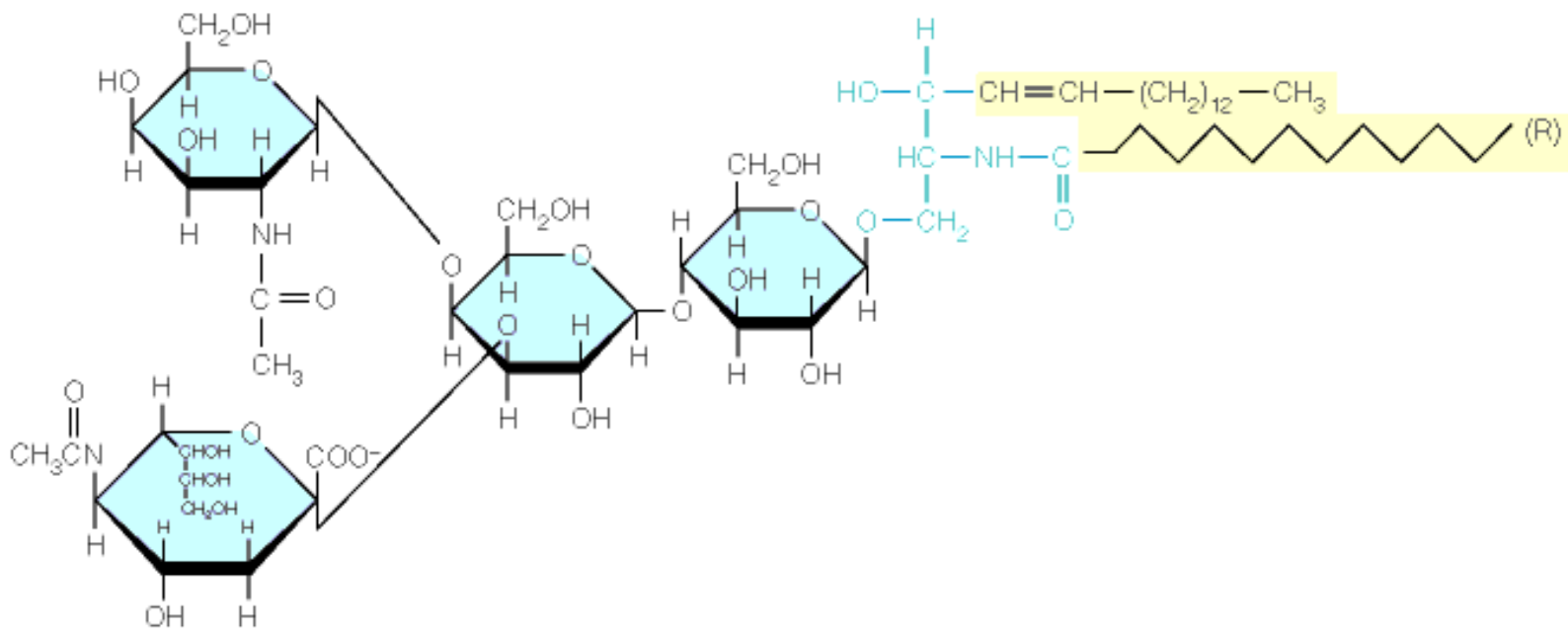

(b) GalNAcβ(1→4)Galβ(1→4)Glcβ(1→1)ceramide

$$\begin{pmatrix} 3 \\ \uparrow \\ \alpha 2 \end{pmatrix}$$
 Sia

Table 19.1



Disease	Defective Enzyme ^a	Accumulated Intermediate
GM ₁ gangliosidosis	① β -Galactosidase	GM ₁ ganglioside
Tay–Sachs disease	② β -N-Acetylhexosaminidase A	GM ₂ (Tay–Sachs) ganglioside
Fabry’s disease	③ α -Galactosidase A	Trihexosylceramide
Gaucher’s disease	④ β -Glucosidase	Glucosylceramide
Niemann–Pick disease	⑤ Sphingomyelinase	Sphingomyelin
Farber’s lipogranulomatosis	⑥ Ceramidase	Ceramide
Globoid cell leukodystrophy (Krabbe’s disease)	⑦ β -Galactosidase	Galactosylceramide
Metachromatic leukodystrophy	⑧ Arylsulfatase A	3-Sulfogalactosylceramide
Sandhoff disease	⑨ N-Acetylhexosaminidases A and B	GM ₁ ganglioside and globoside

^aNumbers refer to enzymes shown in Figure 19.16.

Figure 19.16: Lysosomal pathways for degradation of sphingolipids.

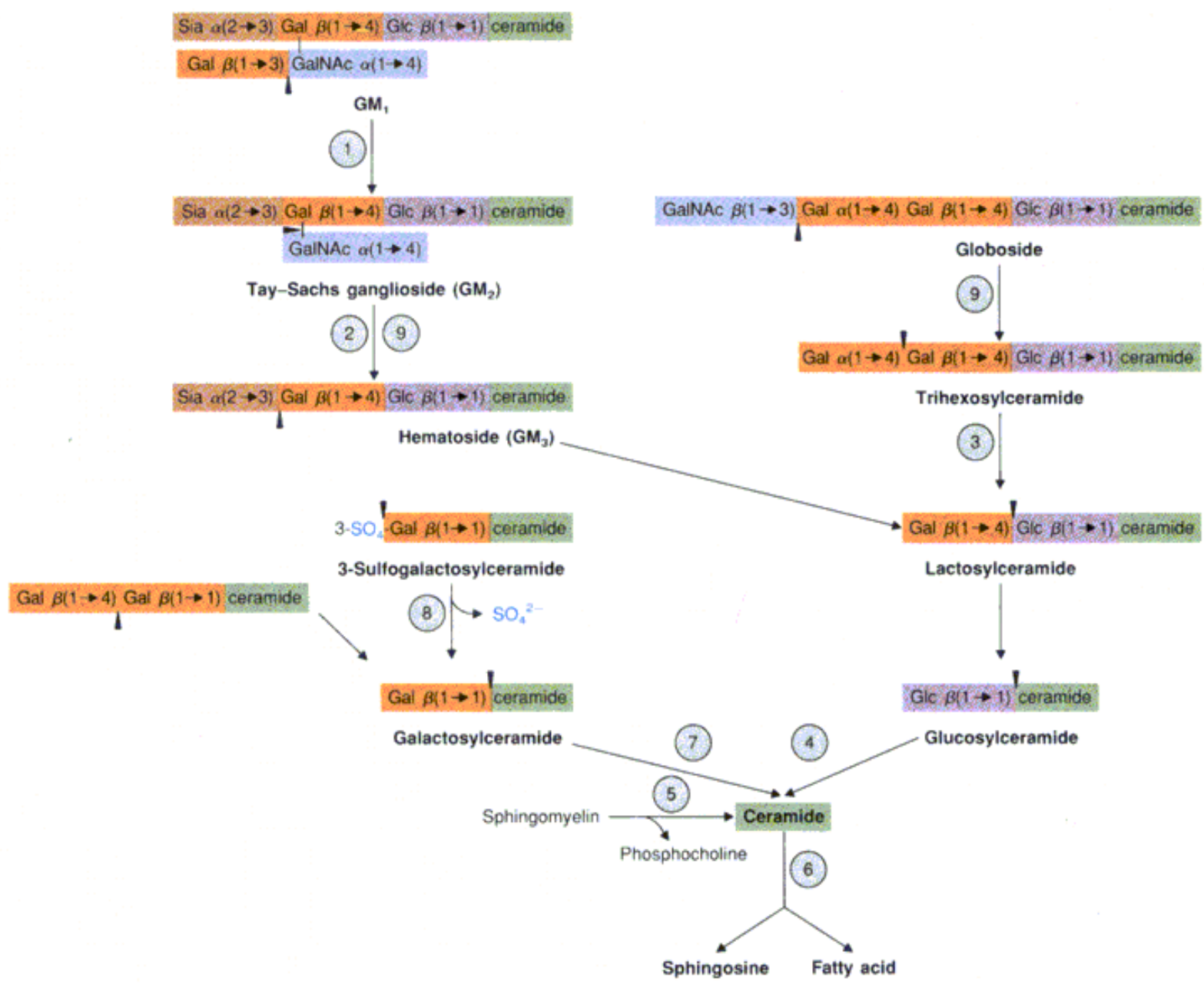

Glycosphingolipids

Glycosphingolipids are sphingolipids, such as the cerebrosides, globosides, sulfatides, and gangliosides, that contain carbohydrate moieties ([Figure 10.8](#)). **Glycosphingolipids** are significant components of the membranes of nerves.

See also: [Cerebrosides](#), [Globosides](#), [Gangliosides](#), [Sphingolipids](#)

INTERNET LINKS:

1. [Glycosphingolipids](#)
-

Globosides

Globosides are sphingolipids that contain multiple sugar moieties ([Figure 19.14](#), [Figure 19.16](#)). By contrast, the [cerebrosides](#) only contain one sugar.

See also: [Glycosphingolipids](#), [Sphingolipids](#), [Ceramide](#)

INTERNET LINKS:

1. [Glycosphingolipids](#)
 2. [Sphingolipid Metabolism](#)
 3. [Sphingoglycolipid Metabolism](#)
-

Gangliosides

Gangliosides are glycosphingolipids that contain the structure of a ceramide plus carbohydrate moieties. Sialic acid is a part of the carbohydrate component. **Gangliosides** differ from cerebrosides in containing sialic acid, whereas the latter contain no sialic acid.

Gangliosides are receptors for specific agents, such as cholera toxin and influenza virus. Cholera toxin binds to **ganglioside** GM1, whereas influenza virus recognizes the sialic acid portion of certain **gangliosides**. The influenza virus then cleaves the **gangliosides** as part of its entry process into cells.

Some **gangliosides** promote the growth of neural tissue in cell culture, suggesting they might be used to promote regeneration of nerve tissue after spinal cord injury.

See also: Sphinglipids, Table 19.1

Sphingomyelin

Sphingomyelin is a phosphosphingolipid made by transferring **choline** from **phosphatidylcholine** to a **ceramide** (**Figure 19.13**).

Sphingomyelin makes up a significant portion of the membrane lipids of the myelin sheath of nerve tissue.

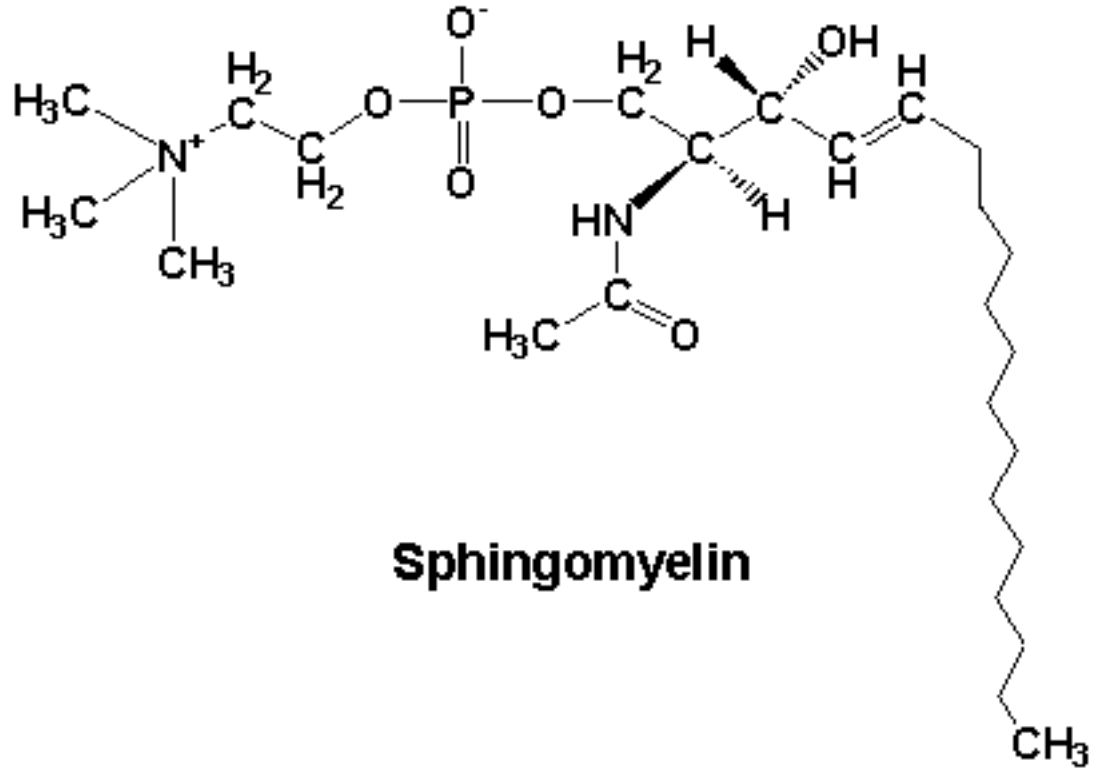

See also: [Sphingolipids](#), [Choline](#), [Phosphatidylcholine](#), [Ceramide](#)

Choline

Choline is a metabolic precursor of the important neurotransmitter, acetylcholine (Reaction 1 below)

CDP is also linked to a phosphorylated form of **choline** to form **CDP-choline** in the predominant mechanism of phosphatidylcholine synthesis (**Figure 19.5**). Oxidation of **choline** to **glycine betaine** is one mechanism of donating a methyl group in biosynthesis of methionine (see **here**).

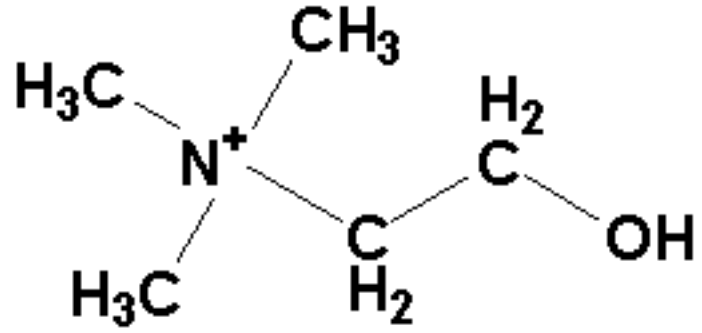

Choline

Sphingomyelin is made by transferring **choline** from **phosphatidylcholine** to a **ceramide** (**Figure 19.13**).

Other reactions involving **choline**:

1. **Choline** + **Acetyl-CoA** \rightleftharpoons **Acetylcholine** + **CoASH** (catalyzed by **Choline Acetyltransferase**)
2. **Acetylcholine** + **H₂O** \rightleftharpoons **Choline** + **Acetate** (catalyzed by **Acetylcholinesterase**)
3. **Choline** + **ATP** \rightleftharpoons **Phosphocholine** + **ADP** (catalyzed by **Choline Kinase**)

See also: **Neurotransmission**, **Acetylcholine**, **Phosphatidylcholine**

Glycine Betaine

Glycine betaine is an oxidation product of [choline](#) in a biosynthetic pathway leading to methionine (see [here](#)). **Glycine betaine** can donate a methyl group to [homocysteine](#) to form [methionine](#). This reaction is the only known biological methylation that does not involve [S-adenosylmethionine](#).

See also: [S-Adenosylmethionine and Biological Methylation](#),
[Metabolism of Sulfur-Containing Amino Acids](#)

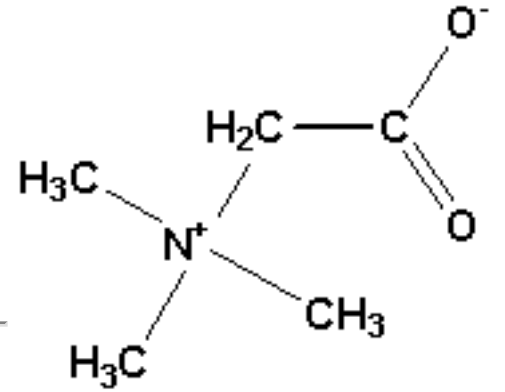

Glycine Betaine

Unnumbered Item

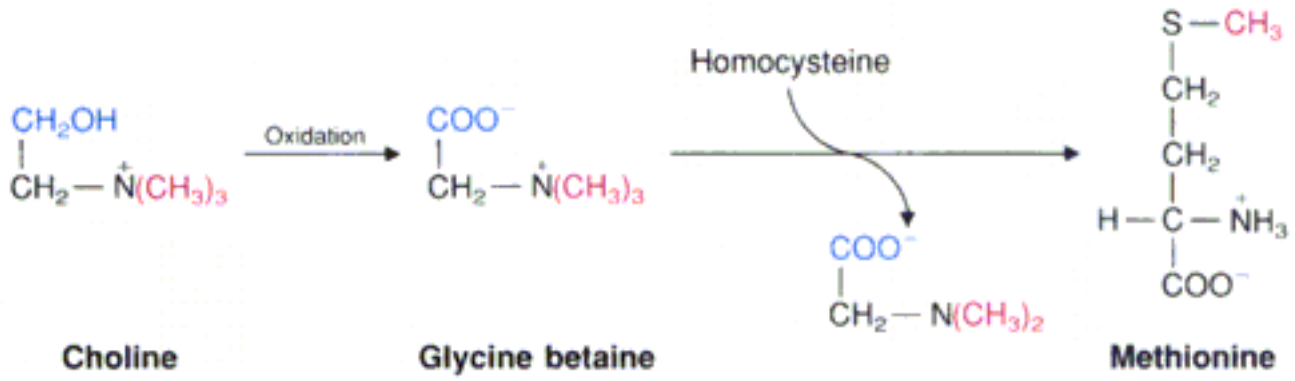

Acetylcholine

Acetylcholine is a chemical messenger in the process of neurotransmission. Neurotransmission usually involves release of a chemical messenger, called the neurotransmitter, from the presynaptic cell followed by its binding to receptors on the postsynaptic cell (nerve, muscle, or gland). Synapses involving **acetylcholine** as the neurotransmitter are called cholinergic

synapses. In cholinergic synapses, synaptic vesicles, each containing about 10^3 to 10^4 **acetylcholine** molecules [Figure 21.33b](#) are stored. Upon stimulation, **acetylcholine** is released and moves towards the postsynaptic membrane of the receptor dendrite ([Figure 21.33b](#)). Binding of **acetylcholine** by receptors triggers the opening of ion channels in the postsynaptic membrane ([Figure 21.33d](#)), initiating an action potential that can be passed on to the next axon ([Figure 21.33e](#)).

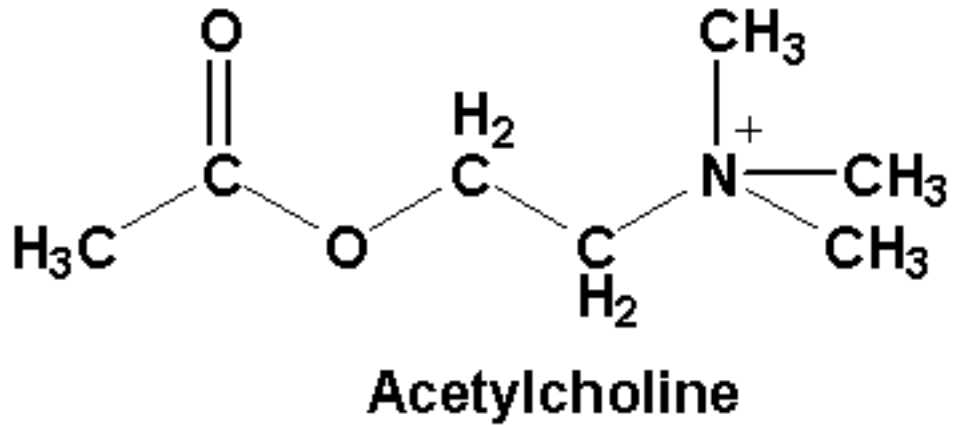

Acetylcholine is synthesized from **choline** and **acetyl-CoA**, by **choline acetyltransferase**, in the axonal terminal bulbs of nerve cells. After **acetylcholine** has been released from vesicles and bound to the receptors, the neurotransmitter is rapidly hydrolyzed by the enzyme **acetylcholinesterase**, yielding choline, which binds poorly to acetylcholine receptors. Degradation of acetylcholine restores the resting potential in the postsynaptic membrane. After it has been released from vesicles and bound to the receptors, the neurotransmitter is rapidly hydrolyzed by the enzyme **acetylcholinesterase**, yielding choline, which binds poorly to acetylcholine receptors. Degradation of **acetylcholine** restores the resting potential in the postsynaptic membrane.

Reactions involving acetylcholine are as follows:

1. **Choline** + **Acetyl-CoA** \rightleftharpoons **Acetylcholine** + **CoASH** (catalyzed by **Choline Acetyltransferase**)
2. **Acetylcholine** + H₂O \rightleftharpoons **Choline** + **Acetate** (catalyzed by **Acetylcholinesterase**)

See also: [Biochemistry of Neurotransmission](#), [Neurotransmitters and Biological Regulators](#)

INTERNET LINKS:

1. Neurotransmitter Receptors and Their Effects

2. Neurotransmitter Newsletter

Figure 21.33: Transmission of a neural impulse across a cholinergic synapse.

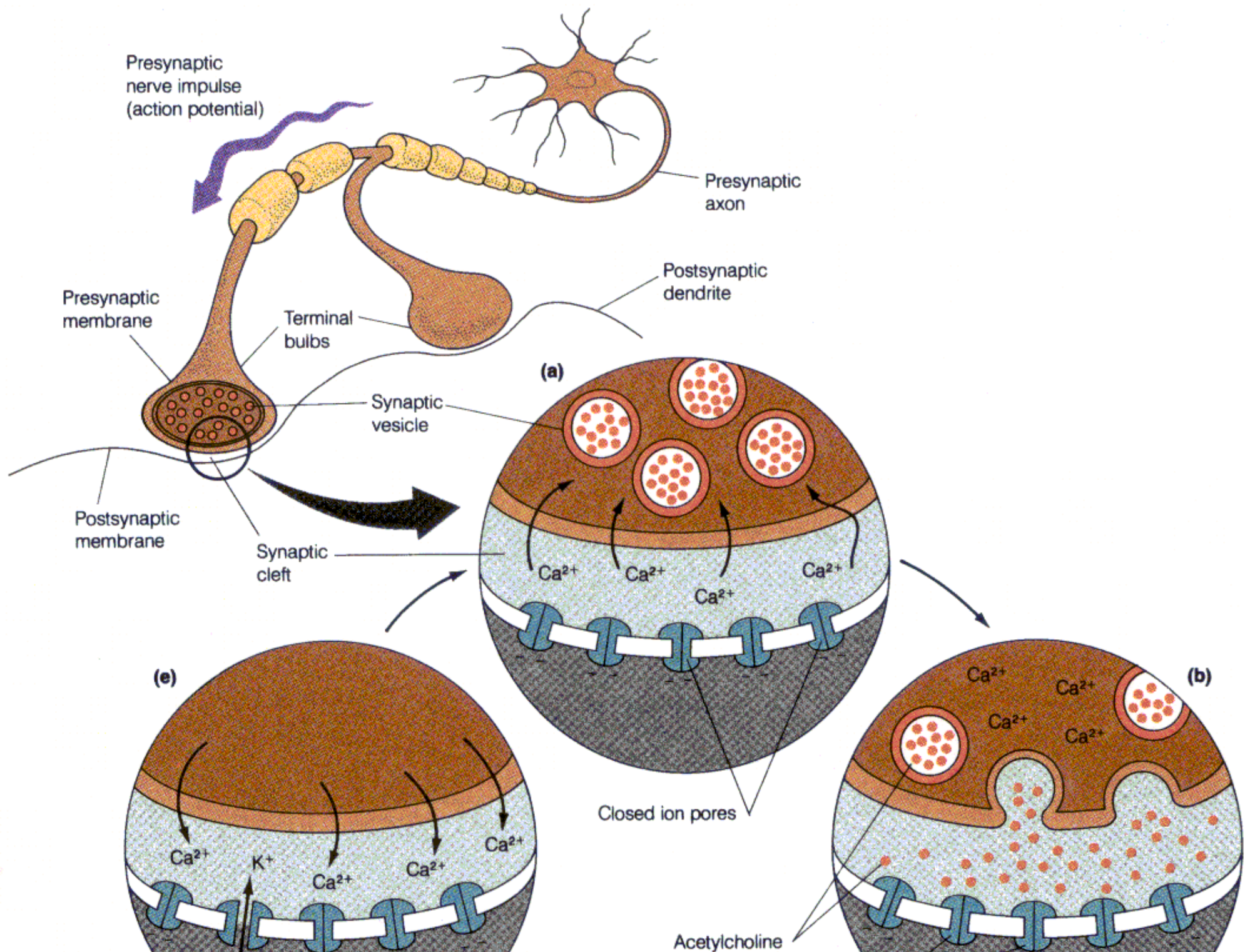

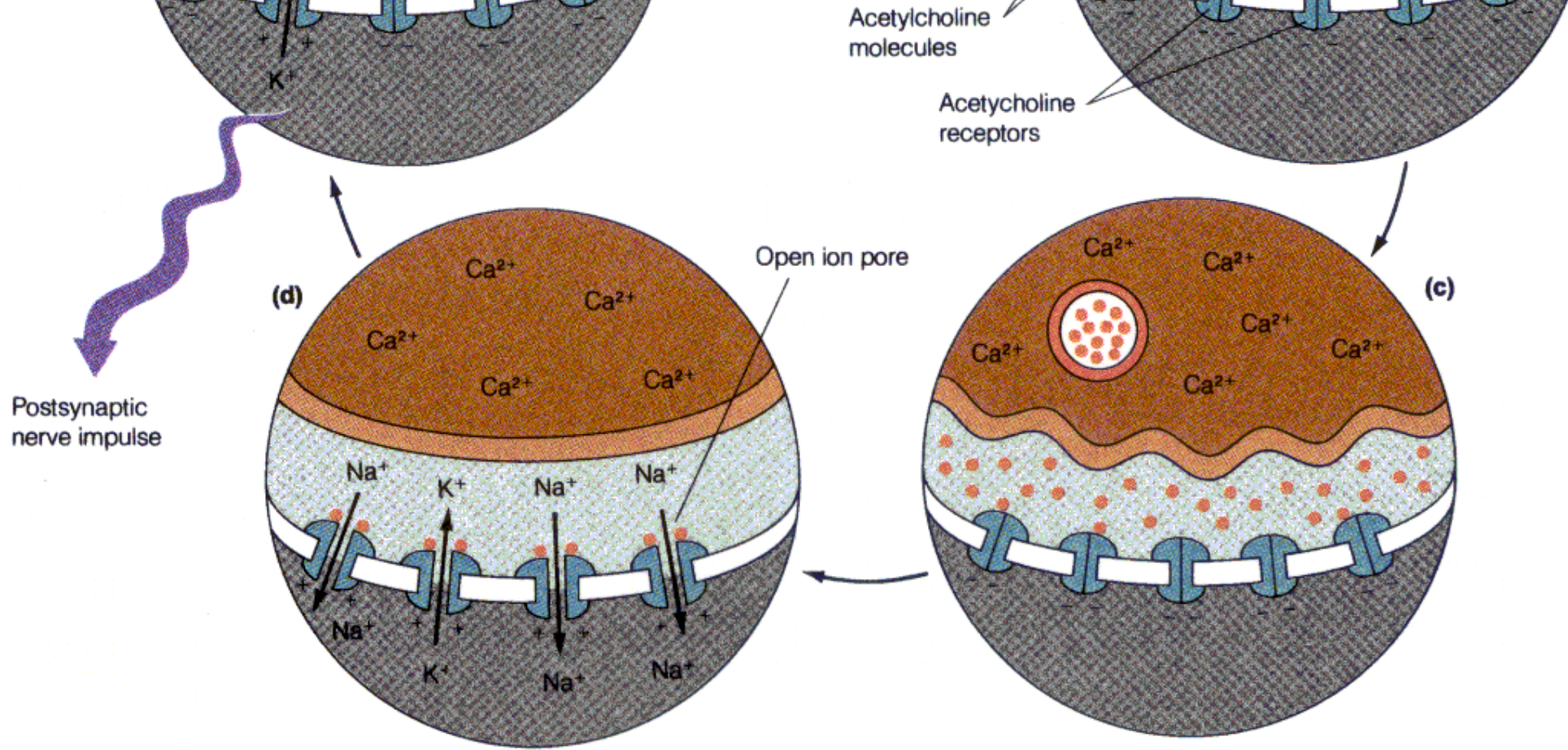

Choline Acetyltransferase



Choline acetyltransferase catalyzes the reaction below:

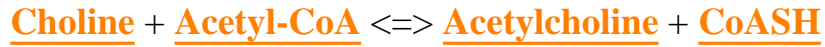

The reaction is the mechanism by which acetylcholine is made for neurotransmission in the axonal terminal bulbs of the cholinergic synapse.

See also: [Biochemistry of Neurotransmission](#), [Neurotransmitters and Receptors](#),
[Neurotransmitters and Biological Regulators](#)

Biochemistry of Neurotransmission

Nerve signals must be transmitted not only within a neuron, but also from one neuron to another or to a muscle or gland cell. Transmission within a nerve cell was discussed [here](#). Cell to cell transmission is discussed as follows:

The Cholinergic Synapse - Neurotransmission usually involves release of a chemical messenger, called the neurotransmitter, from the presynaptic cell followed by its binding to receptors on the postsynaptic cell (nerve, muscle, or gland). Synapses involving [acetylcholine](#) as the neurotransmitter are called **cholinergic synapses**. Choline is synthesized principally as part of [phosphatidylcholine](#). A **cholinergic synapse** is shown in [Figure 21.33](#). Signals move as follows:

The nerve impulse (action potential) moves down the presynaptic axon to the terminal bulb; the change in membrane potential in the bulb causes the opening of voltage-gated calcium channels, allowing Ca^{2+} ions to pass from the surrounding space into the axonal bulb ([Figure 21.33a](#)).

Within the bulb are synaptic vesicles, each containing about 10^3 to 10^4 acetylcholine molecules. The increase in Ca^{2+} concentration causes these vesicles to fuse with the axonal membrane and open, spilling their contents into the synaptic cleft ([Figure 21.33b](#)).

The postsynaptic membrane of the receptor dendrite has specific acetylcholine receptors, toward which the neurotransmitter diffuses ([Figure 21.33c](#)).

Binding of acetylcholine triggers the opening of ion channels in the postsynaptic membrane ([Figure 21.33d](#)), initiating an action potential that can be passed on to the next axon ([Figure 21.33e](#)). The action potential involves a wave of membrane permeability changes that lead to sodium influx and potassium efflux.

The receptors here are referred to as nicotinic acetylcholine receptors, because they can bind the alkaloid [nicotine](#). The other major type of acetylcholine receptor, which participates in different synapses, is called the muscarinic acetylcholine receptor.

Acetylcholine is synthesized by [choline acetyltransferase](#) from [choline](#) and [acetyl-CoA](#) in the axonal terminal bulbs. After acetylcholine has been released from vesicles and bound to the receptors, the neurotransmitter is rapidly hydrolyzed by the enzyme [acetylcholinesterase](#), to yield choline, which binds poorly to acetylcholine receptors. Degradation of acetylcholine restores the resting potential in the postsynaptic membrane.

To ready the synapse for another impulse (which must occur about 1000 times per second), the empty synaptic vesicles, which are returned to the axonal terminal bulb by endocytosis, must be refilled with acetylcholine. This task is accomplished by an acetylcholine transporter protein, which brings newly synthesized acetylcholine into the vesicles by exchanging it for protons. As the protons are returned to the cytosol from the vesicles, acetylcholine is transported in the opposite direction.

Nicotinic acetylcholine receptor - [Figure 21.34](#) shows the **nicotinic acetylcholine receptor**. The central pore is a gated ion channel. Post synaptic membranes are packed densely with receptors (20,000 per square micrometer). Electric organs of electric rays and electric eels contain stacks of cells called electroplaques, with a density of 10^5 receptors per square micrometer.

[Acetylcholinesterase](#), the enzyme that hydrolyzes acetylcholine to choline in the postsynaptic membrane, is a serine esterase inhibited by diisopropyl fluorophosphate, sarin, physostigmine, and parathion ([Table 11.4](#)). These substances are extremely toxic and cause paralysis. Other toxins block the acetylcholine receptor (antagonists) or lock it open (agonists). Nicotine is an agonist.

Adrenergic Receptor - Another kind of synapse uses [catecholamines](#) instead of acetylcholine and is called **adrenergic**. Catecholamines include [dopamine](#), [norepinephrine](#), and [epinephrine](#). In patients with Parkinsonism, dopamine levels are abnormally low in a particular area of the brain. Dopamine does not cross the blood-brain barrier, however, so patients do not respond to treatment with dopamine.

[Dopa](#), on the other hand, a precursor of dopamine, does cross the barrier, giving relief to many individuals with Parkinsonism. Dopaminergic neurons (neurons secreting dopamine) may be involved in schizophrenia. In this case, the neurons secrete too much dopamine.

See also: [Neurotransmitters and Receptors](#), [Neurotransmitters and Biological Regulators](#)

INTERNET LINKS:

1. [Neurotransmitter Receptors and Their Effects](#)
 2. [Neurotransmitter Newsletter](#)
-

Neurotransmission

The resting potential of nerve cells and their unique structure provide the basis for the process of **neurotransmission**. Nerve cells at rest are close to an equilibrium concentration of potassium, but not sodium. Permeabilizing the membrane to ions causes sodium ions to rush in. Nerve cells have gated channels for facilitated transport of Na^+ and K^+ . In the resting state, the gates are closed ([Figure 10.32](#)) and the resting potential is about -60 mV. On stimulation at a particular region of an axon, the sodium activation gates open. Sodium rushes in and the membrane potential moves to +40 mV ([Figure 10.33](#)). This, in turn, causes the potassium gates to open and potassium leaks out, which reverses the potential gain, but causes it to overshoot to -70 mV. This causes the sodium inactivation gates (different from activation gates) to close and a refractory period ensues during which the sodium channels cannot open until the membrane fully repolarizes and the potassium gate closes.

Depolarization as described above occurs in a single region of a nerve fiber. **Transmission** of the signal along the fiber occurs because the influx of sodium and efflux of potassium in one section of the fiber causes similar disturbances in adjacent regions of the fiber and the depolarization/repolarization proceeds down the fiber quickly. The traveling pulse is called the **action potential**. Typical speeds are from 1 to 100 meters per second.

The **action potential** does not appreciably decrease with distance transmitted.

The **action potential** is like a digital signal - it is either on or off.

After an impulse has passed, the region behind it in the axon is unable to transmit another impulse during a refractory period of several milliseconds.

See also: [Resting Potential](#), [Action Potential](#), [Biochemistry of Neurotransmission](#) (Chapter 21)

Figure 10.32: The action potential.

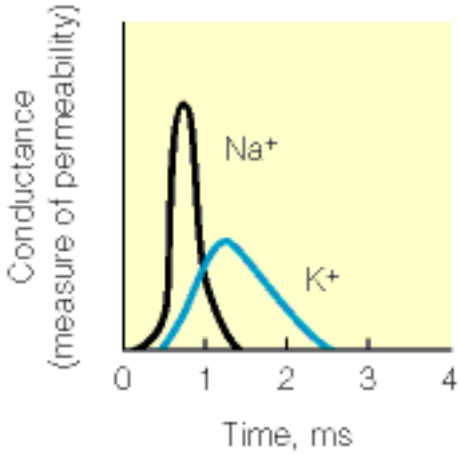

(a)

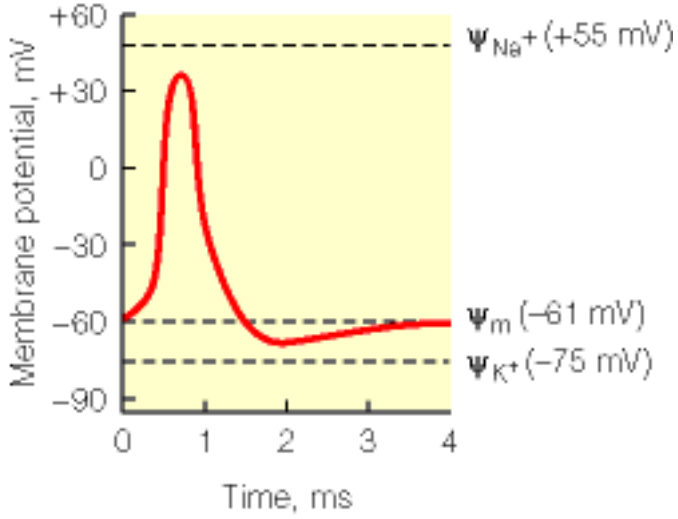

(b)

Figure 10.33: Transmission of the action potential.

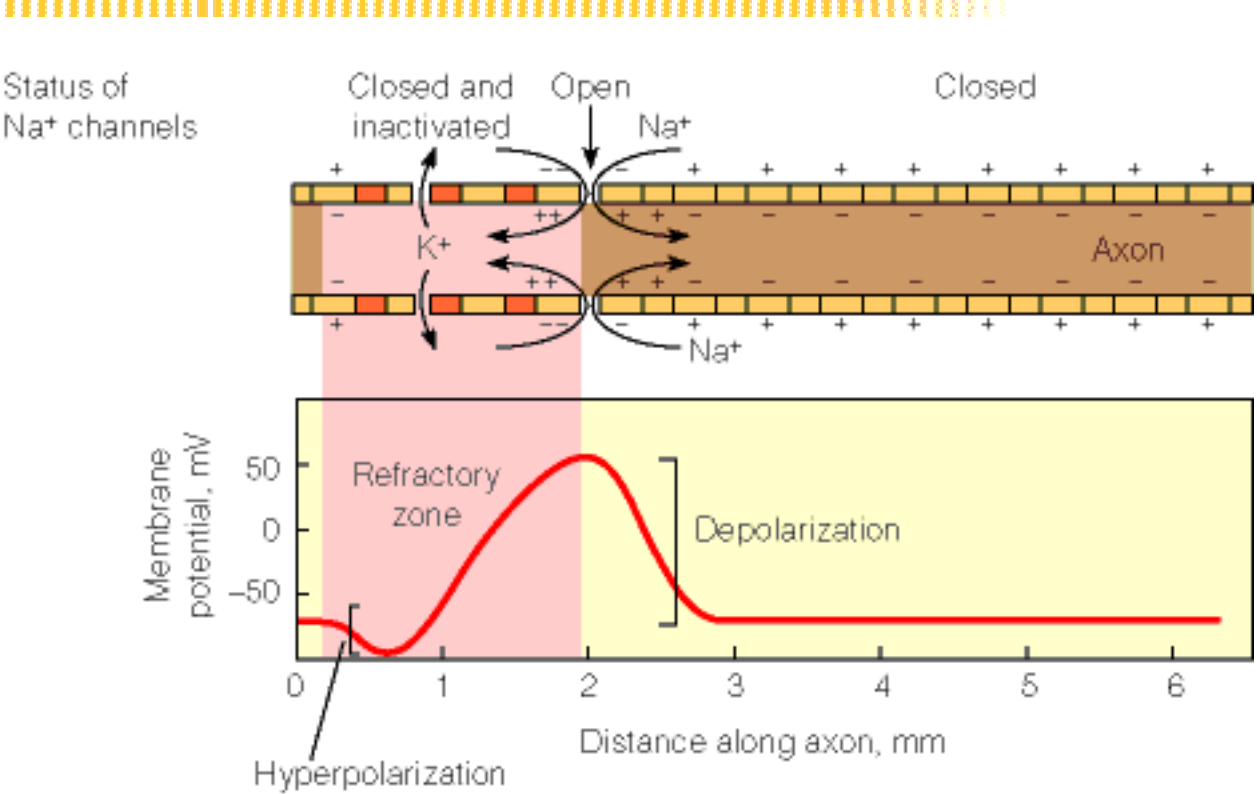

(a) Time = 0

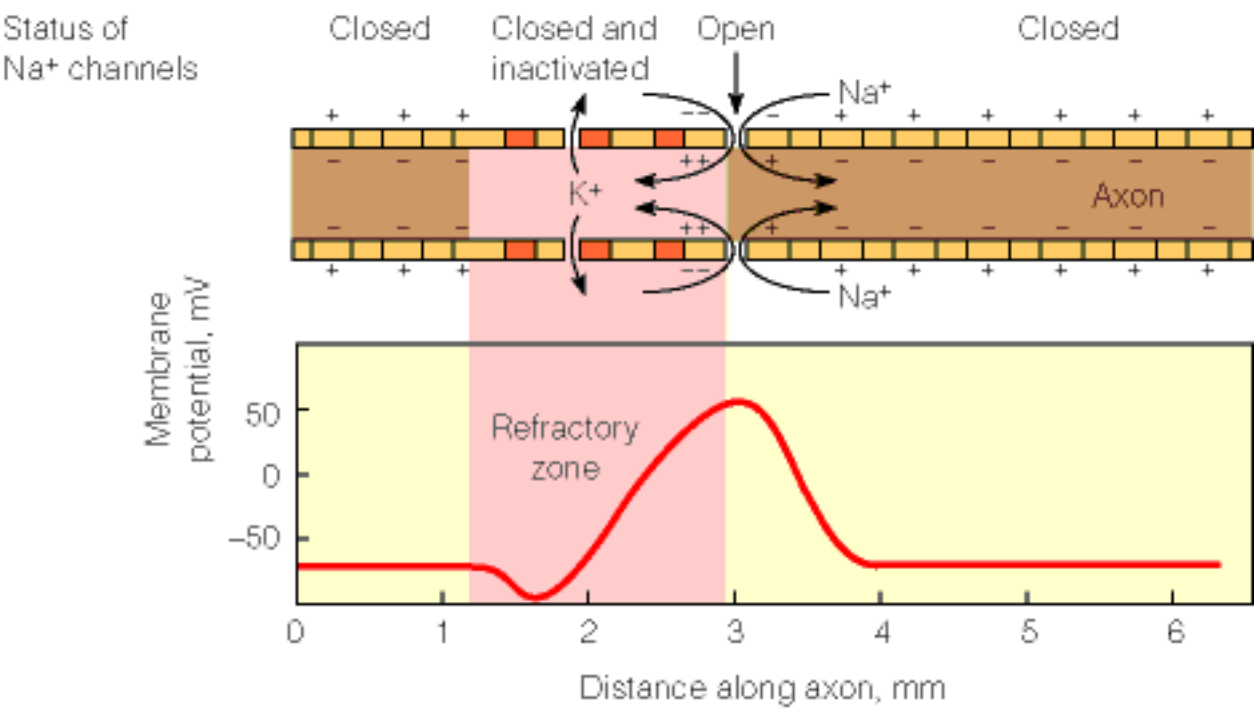

(b) Time = 1 ms

Adapted from J. Darnell et al., Molecular Cell Biology. © 1986, 1990, 1996 by Scientific American Books, Inc. Used with permission by W. H. Freeman and Company.

Resting Potential

Cells create potential differences by pumping ions across membranes. The Nernst equation defines the electrical potential arising from differences in ionic concentration created by the various pumps. It relates the membrane resting potential to the charge and concentration of ions on either side of a membrane.

At equilibrium,

$$\frac{RT}{ZF} \ln \frac{[M^Z]_{out}}{[M^Z]_{in}} = \Delta\psi \quad (10.8)$$

where Z is the ionic charge, F is the Faraday constant, $[M^Z]$ is the concentration of ion M of charge Z and $\Delta\psi$ is the potential expressed in millivolts.

For monovalent cations ($Z = +/-1$), the Nernst equation reduces to

$$\Delta\psi = \pm 59 \log_{10} \frac{[M]_{out}}{[M]_{in}} \quad (10.9)$$

The **resting potential** is the potential difference across the membrane of a nerve axon arising from the imbalance in ionic concentrations ([Figure 10.30](#)). This is easily measured in the giant axons of the squid by inserting electrodes and measuring the potential across the membrane.

See also: [Transport Mechanisms](#), [Neurotransmission](#)

Figure 10.30: Use of squid giant axons for studies of neural transmission.

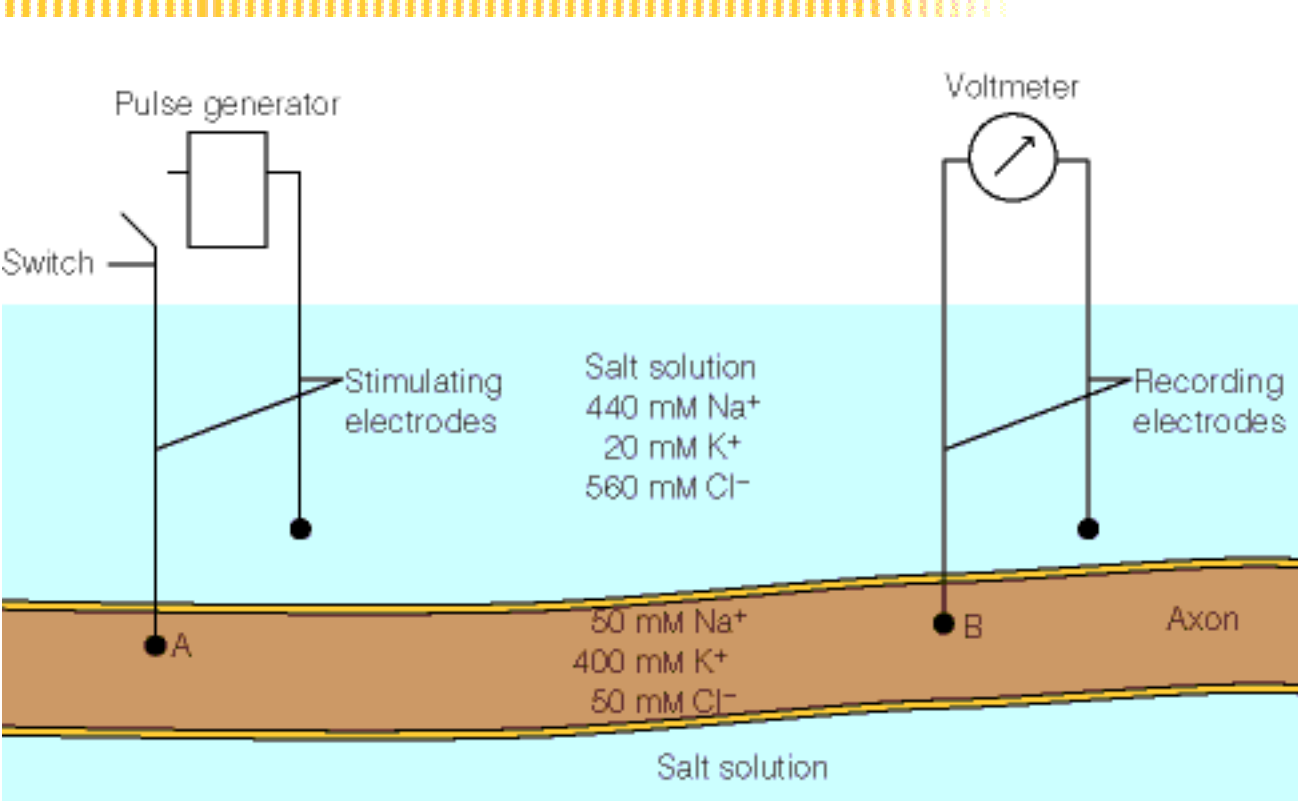

Membrane Proteins

Membrane proteins can be distinguished from other globular proteins by the high proportion of hydrophobic amino acids they contain.

The nonpolar amino acids are typically arranged in parts of the protein that are embedded in the nonpolar part of the lipid bilayer. These segments are often α -**helical** and can sometimes be identified by plotting the hydrophobicity of the polypeptide sequence.

Membrane proteins are of two general types-integral and peripheral. Integral membrane proteins project through both sides of the lipid bilayer whereas peripheral membrane proteins project through only one side of the lipid bilayer (**Figure 10.10**). Some membrane proteins are also covalently linked to either carbohydrate or lipid moieties. As can be seen in **Table 10.4**, the lipid, protein and carbohydrate composition of membranes can vary considerably.

In the erythrocyte membrane, proteins such as **ankyrin** and the **anion channel protein**, help to link the membrane to the underlying intracellular backbone.

See also: **Table 10.5**, **Erythrocyte Membrane**, **Bacteriorhodopsin**

INTERNET LINKS:

1. **Lipid Bilayer Simulation**
 2. **Lipid Bilayer Models for RasMol**
-

Figure 10.10: Structure of a typical cell membrane.

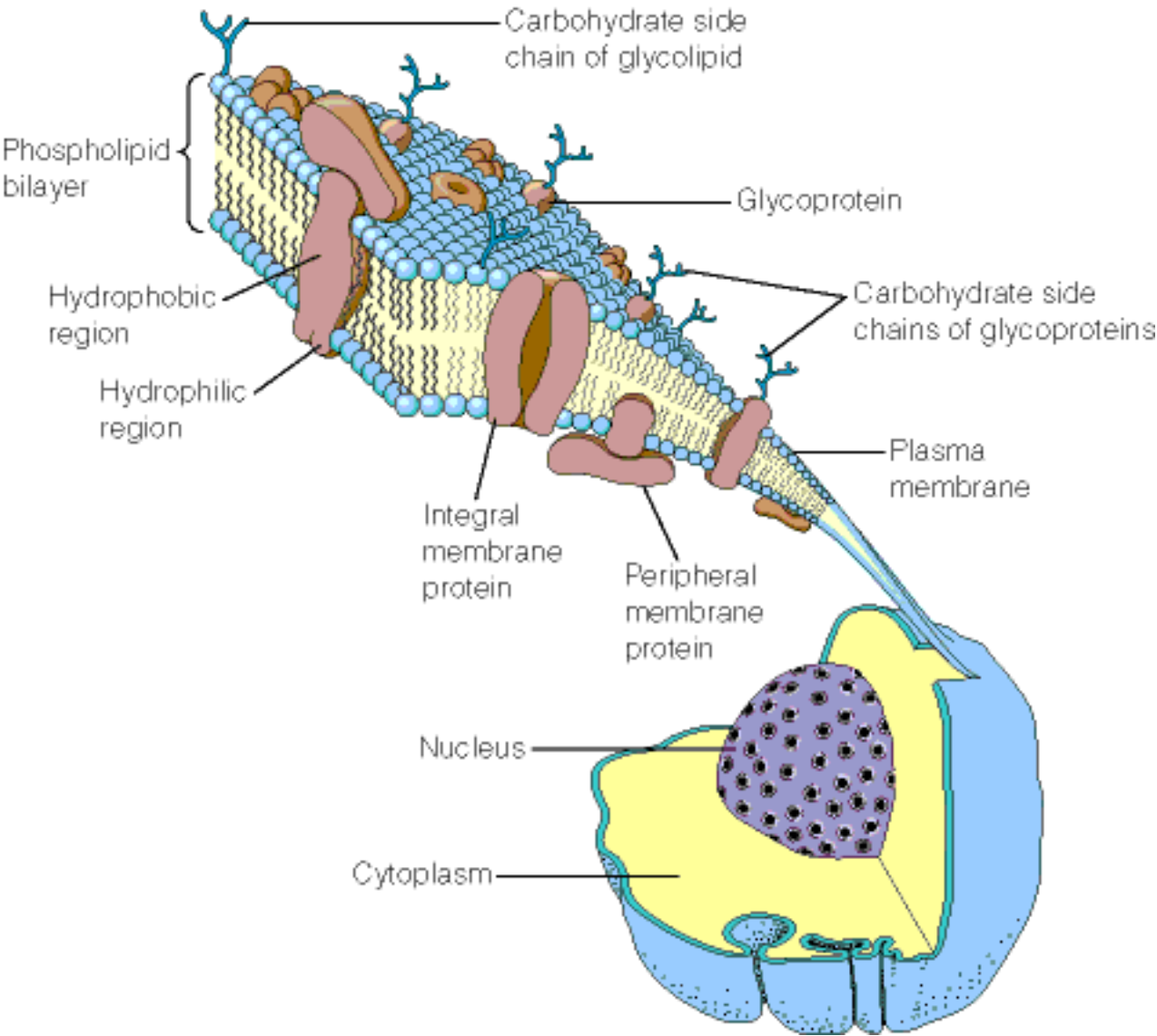

Table 10.4



Membrane	Percent by Weight		
	Protein	Lipid	Carbohydrate
Myelin	18	79	3
Human erythrocyte (plasma membrane)	49	43	8
Bovine retinal rod	51	49	0
Mitochondria (outer membrane)	52	48	0
Amoeba (plasma membrane)	54	42	4
Sarcoplasmic reticulum (muscle cells)	67	33	0
Chloroplast lamellae	70	30	0
Gram-positive bacteria	75	25	0
Mitochondria (inner membrane)	76	24	0

Source: Adapted from G. Guidotti, *Annu. Rev. Biochem.* (1972) 41:731.

Ankyrin



Ankyrin is a peripheral membrane protein of the erythrocyte membrane ([Figure 10.17](#)). It functions to anchor the anion channel protein to the membrane skeleton ([Figure 10.18](#), [Table 10.5](#)).

See also: [Membrane Proteins](#), [Erythrocyte Membrane](#), [Passive Transport Mechanisms](#), [Anion Channel Protein](#)

Table 10.5



Band No. ^a	Protein Name	Subunit Molecular Weight	Probable State of Assembly	Number of Copies per Cell	Role
Peripheral Proteins					
1	α -Spectrin	260,000	$\alpha_2\beta_2$ tetramers	10^5 tetramers	Membrane skeleton
2	β -Spectrin	225,000			
2.1	Ankyrin	215,000	Monomer	10^5	Links skeleton to band 3
*	Adducin	$\left\{ \begin{array}{l} 105,000 \\ 100,000 \end{array} \right\}$	Heterodimer	3×10^4	
4.1	—	78,000	Monomer	2×10^5	Involved in spectrin junctions
4.2	Palladin	72,000	?	2×10^5	?
4.9	Demantin	48,000	Trimer?	5×10^4	Involved in spectrin-actin interaction
5	Actin	43,000	Oligomers of 12–17 units	5×10^5	Involved in spectrin junctions
*	Tropomyosin binding protein	43,000	Monomer	3×10^4	Binds tropomyosin
6	Glyceraldehyde-3-phosphate dehydrogenase	35,000	Tetramer	5×10^5	Glycolytic enzyme
*	Tropomyosin	$\left\{ \begin{array}{l} 29,000 \\ 27,000 \end{array} \right\}$	Heterodimer	7×10^4	Binds to actin
7	—	29,000	?	5×10^5	?
8	—	23,000	?	10^5	?
Integral Proteins					
3	—	89,000	Dimer + tetramers	10^6 dimers	Anion channel
4.5		55,000	?	1.5×10^6	Glucose transport
	Glycophorin A	31,000	Dimer	4×10^5	Cell recognition
	Glycophorin B	23,000	?	$\sim 10^5$	Cell recognition
	Glycophorin C	29,000	?	$\sim 10^5$	Linkage to 4.1?

Source: Most of the data are from V. Bennett, *Annu. Rev. Biochem.* (1985) 54:273–304.

^aBand numbers correspond to those in Figure 10.17. The glycophorins do not stain well with protein stains but can be detected by carbohydrate-specific stains.

*Components that do not constitute major bands on gels but have demonstrable roles in membranes.

Erythrocyte Membranes

Erythrocytes (red blood cells) can be easily lysed to release their contents and yield **membrane ghosts**. These are large vesicles that represent a nearly pure preparation of the plasma **membrane** of the cells. The lipid composition and distribution between the inner and outer leaflets of the **bilayer membrane** are shown in [Table 10.3](#) and [Figure 10.15](#), respectively.

Peripheral membrane proteins can readily be removed by changes in ionic strength or pH. Extraction of the membrane ghosts with detergent removes integral membrane proteins that are not part of the membrane skeleton and leaves behind only the membrane skeleton proteins. The proteins of the intact ghost and membrane skeleton only are shown in [Figure 10.17](#).

The primary integral proteins of ghosts are bands 3, band 4.5, and glycoporphins A, B, and C ([Table 10.5](#)). Band 3 protein helps to anchor the membrane to the membrane skeleton through interaction with the ankyrin protein.

Band 3 Protein - the most abundant erythrocyte membrane protein. It is an anion channel which facilitates the exchange of HCO_3^- for Cl^- .

Glycophorins - a group of integral membrane proteins with a variety of functions. They are covalently linked to external, carbohydrate domains that are linked to sialic acid residues.

The membrane skeleton is responsible for the shape of the membrane ghost. A schematic structure of the protein is shown in [Figure 10.18](#). The skeleton is a two-dimensional network of some of the peripheral membrane proteins. The roles of some of these are as follows:

Spectrin - elongated molecules made up of $\alpha_2\beta_2$ tetramers. The tetramers form a chain-like structure that links the many components of the ghost and the skeleton. Spectrins contain a large portion of their structure in the form of an α -helix and appear to be linked at their ends through short chains of actin molecules, together with band 4.1 protein and adducin.

Ankyrin - anchors the membrane to the skeleton by linking with spectrin and band 3 protein.

Band 4.1 - also helps anchor the membrane to the skeleton by linking spectrin to glycoporphin.

See also: [Membrane Asymmetry](#), [Membrane Proteins](#)

Table 10.3



Lipid	Percentage of Total Composition in			
	Human Erythrocyte Plasma Membrane	Human Myelin	Beef Heart Mitochondria	<i>E. coli</i> Cell Membrane
Phosphatidic acid	1.5	0.5	0	0
Phosphatidylcholine	19	10	39	0
Phosphatidylethanolamine	18	20	27	65
Phosphatidylglycerol	0	0	0	18
Phosphatidylinositol	1	1	7	0
Phosphatidylserine	8.0	8.0	0.5	0
Sphingomyelin	17.5	8.5	0	0
Glycolipids	10	26	0	0
Cholesterol	25	26	3	0
Others	0	0	23.5	17

Source: Data from C. Tanford, *The Hydrophobic Effect* (New York: Wiley, 1973).

Figure 10.15: An integral membrane protein.

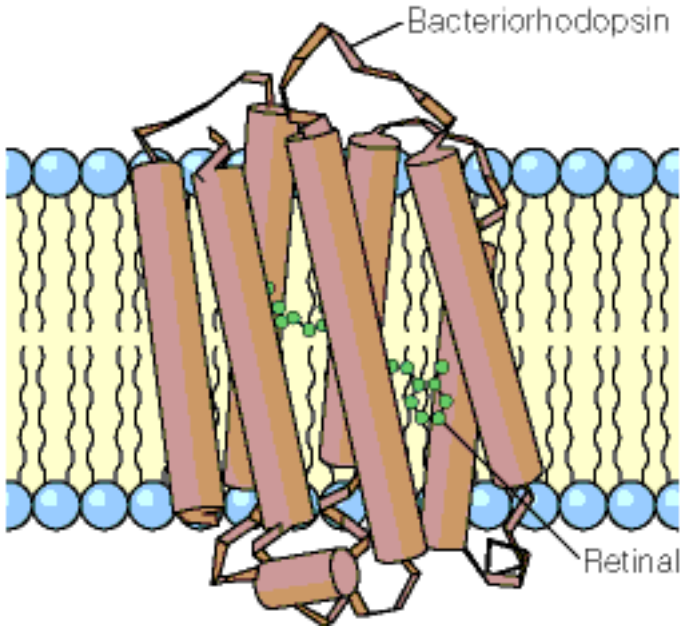

Adapted from R. Henderson, J. M. Baldwin, J. A. Ceska, F. Zemlin, E. Beckman, and K. H. Downing, *J. Mol. Biol.* (1990) 213:899-929. © 1990 Academic Press.

Glycophorins

Glycophorins are integral erythrocyte cell membrane proteins, which apparently serve a variety of functions. Each of the glycophorin proteins has an external carbohydrate-carrying domain, and the surface carbohydrates may be involved in cell recognition. There is also evidence that **glycophorin C** interacts with the peripheral protein 4.1 via its intracellular domain.

See also: [Erythrocyte Membrane](#), [Peripheral Protein 4.1](#), [Table 10.5](#)

Band 4.1 Protein



Band 4.1 protein is a peripheral membrane protein in erythrocytes ([Table 10.5](#)). **Band 4.1 protein** is found at spectrin junctions in the membrane skeleton ([Figure 10.18](#)).

See also: [Erythrocyte Membrane](#), [Spectrin](#)

Spectrin

Spectrin is a peripheral membrane protein of erythrocytes. It contains two copies each of an α and a β subunit, forming a tetramer. **Spectrin** acts like a fiber, linking together the various components of the erythrocyte membrane skeleton ([Figure 10.18](#)).

See also: [Erythrocyte Membrane](#), [Table 10.5](#)

Membrane Asymmetry

The **lipid bilayer** defines the boundary between the cytoplasm and the environment surrounding a cell. One layer of the **lipid bilayer** faces the cytoplasm and the other faces the external environment. These two different layers are referred to as the inner leaflet and outer leaflet, respectively. [Figure 10.14](#) shows that the lipid composition of the inner and outer leaflets can vary considerably and are not in an equilibrium state, where the compositions of the leaflets would be the same. Because the two leaflets of the **membrane** must deal with different surroundings, it seems to make sense that they are usually quite different in composition and structure.

One feature of **lipid bilayers** that helps to maintain the asymmetric distribution of lipids within it is the relatively slow way in which glycerophospholipid molecules can "flip" from one side of the bilayer to the other in the absence of enzymatic action. This flipping is called transverse diffusion and is a process that can be enhanced by a class of enzyme called [translocases](#).

Two other features of **membrane** structure illustrate its asymmetry. First, carbohydrates are always attached on the outside surface of the cell. Second, **membrane** protein orientation (flipping) does not occur, so that proteins always maintain the same polarity.

See also: [Molecular Structures and Properties of Lipids](#), [Membrane Fluidity](#), [Glycerophospholipids](#)

INTERNET LINKS:

1. [Lipid Bilayer Simulation](#)
 2. [Lipid Bilayer Models for RasMol](#)
-

Figure 10.14: Phospholipid asymmetry in plasma membranes.

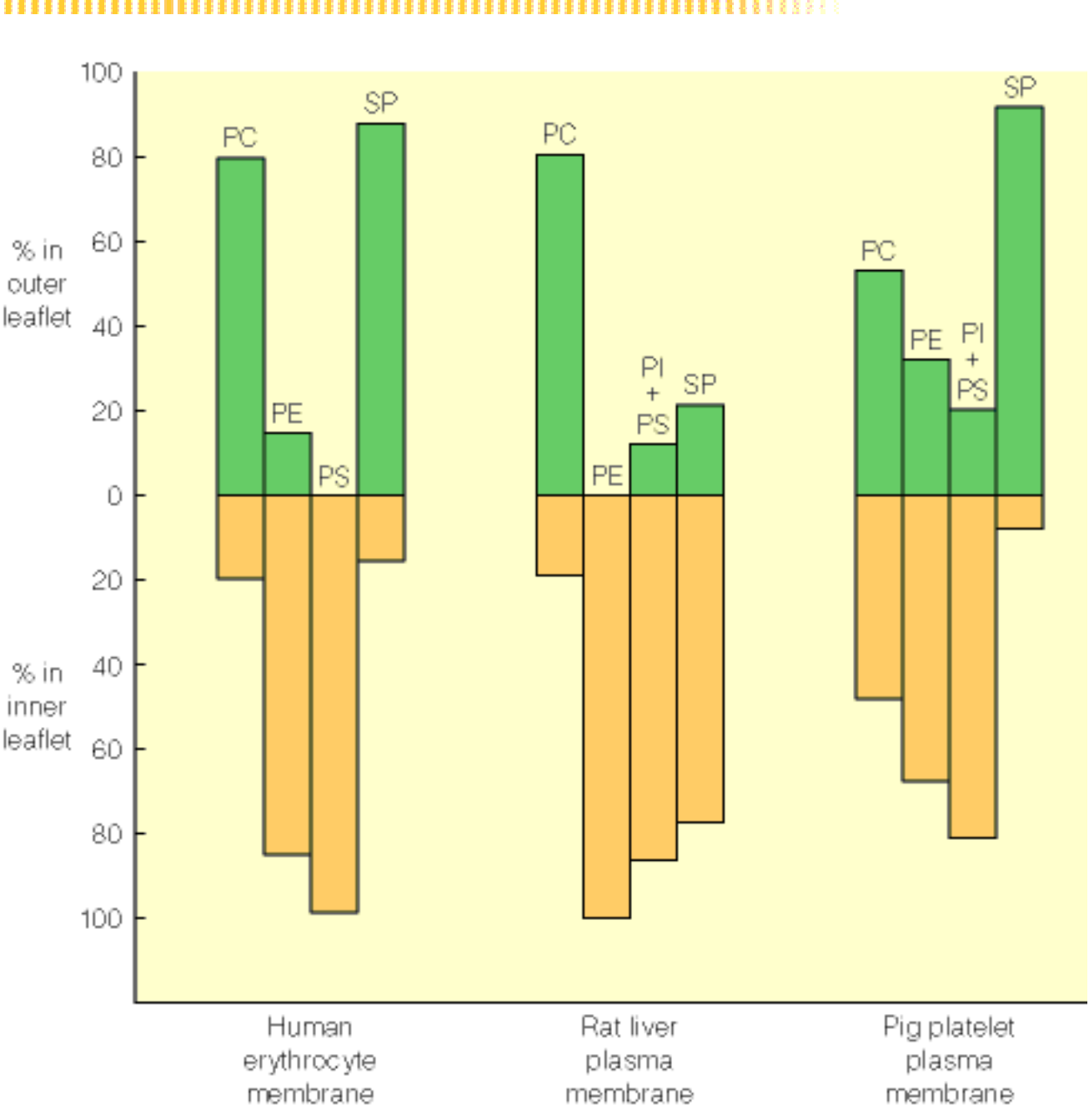

Translocases

One feature of [lipid bilayers](#) that helps to maintain the asymmetric distribution of lipids within it is the relatively slow way in which [glycerophospholipid](#) molecules can "flip" from one side of the bilayer to the other in the absence of enzymatic action. This flipping is called transverse diffusion and is a process that can be enhanced by a class of enzyme called **translocases**.

See also: [Membrane Asymmetry](#)

Phospholipid Bilayer

The membranes of cells are largely composed on of a **phospholipid bilayer** and proteins. Most of our current information concerning biological membranes is summarized by the fluid mosaic model proposed by S. J. Singer and G. L. Nicholson in 1972. This is the model depicted in [Figure 10.10](#).

The fluid, asymmetric **lipid bilayer** carries within it a host of proteins. Some of them, called peripheral membrane proteins, are only partially buried in the lipid matrix and are exposed at only one membrane face or the other. Other proteins, the integral membrane proteins, are largely buried within the membrane but are exposed on both faces. Integral proteins are frequently involved in transmitting either specific substances or chemical signals through the membrane. The whole membrane is a fluid mosaic of lipids and proteins.

See also: [Molecular Structures and Properties of Lipids](#), [Translocases](#)

Molecular Structures and Properties of Lipids

Lipids are diverse in their structure and properties. **Lipids** include the [lipid-soluble vitamins](#), [steroid hormones](#), [prostaglandins](#), [fatty acids](#), triacylglycerols ([fats](#)), [glycerophospholipids](#), [sphingolipids](#) and derivatives of these compounds, as well.

Though **lipids** as a group are more nonpolar than other biological molecules, most of them have some amphiphilic character. Fatty acids, for example, illustrate the amphiphilic nature of many **lipids**. (see [here](#), [Figure 10.1](#)). Fatty acids have a polar end containing the carboxyl group and a nonpolar tail, allowing it to readily form micelles in water. Fatty acids may be saturated (no double bonds) or unsaturated (contain one or more double bonds). Virtually all biologically produced unsaturated fatty acids contain *cis* double bonds, which induce a bend in the molecules.

When three fatty acids are esterified to [glycerol](#), the resulting molecule is a fat (if solid at room temperature) or an oil (if liquid at room temperature). Fats which are rich in unsaturated fatty acids are typically oils. Esterification of the fatty acids to make fats greatly diminishes the hydrophilic nature of the polar end of the original fatty acid. Consequently, fats are very nonpolar and do not form micelles readily. Fats are used to store energy.

Some **lipids**, such as glycerophospholipids and some **sphingolipids**, have a very nonpolar end containing a phosphate. These molecules readily form **lipid** bilayers and are important in forming membranes surrounding cells ([Figure 10.5](#)). In this case, the polar portions face outwards, towards water, and the nonpolar moieties associate with each other inside the bilayer.

Another class of **lipids**, called **steroids**, is a large group of molecules that includes [cholesterol](#) and is only weakly amphiphilic due to few polar groups ([Figure 10.9](#)). Cholesterol is a prominent component of **lipid** bilayers, but its bulky shape tends to disrupt the regularity of the membrane.

See also: [Fatty acids](#), [Fats](#), [Glycerophospholipids](#), [Sphingolipids](#), [Steroids](#), [Lipid Bilayer](#)

β -Carotene

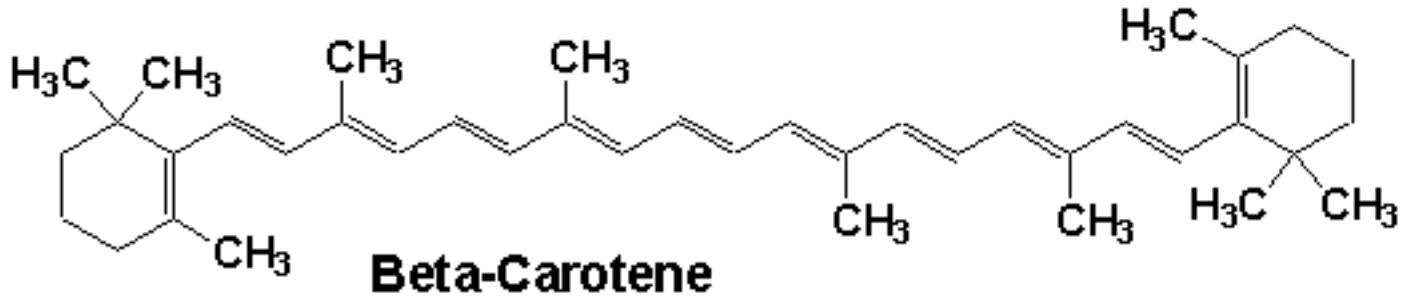

β -Carotene is an isoprenoid found abundantly in carrots that is an accessory photosynthetic pigment and a precursor of all-trans-retinol ([Vitamin A](#)) ([Figure 19.25](#)).

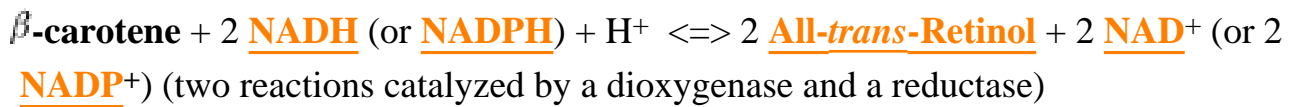

β -Carotene is made in plants from lycopene.

See also: [Lipid-Soluble Vitamins](#), [Figure 17.7](#), [Lycopene](#)

INTERNET LINK: [Retinol Metabolism](#)

Figure 19.25: Synthesis of vitamin A₁, all-*trans*-retinol.

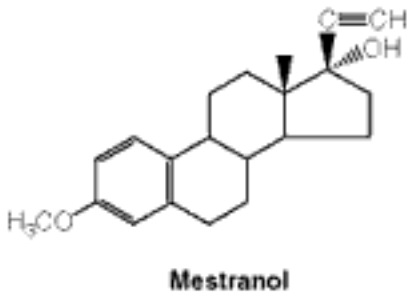
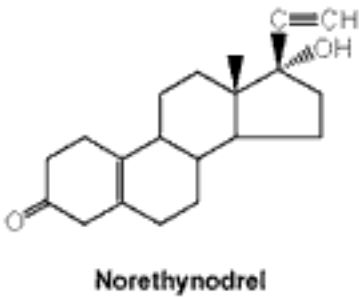
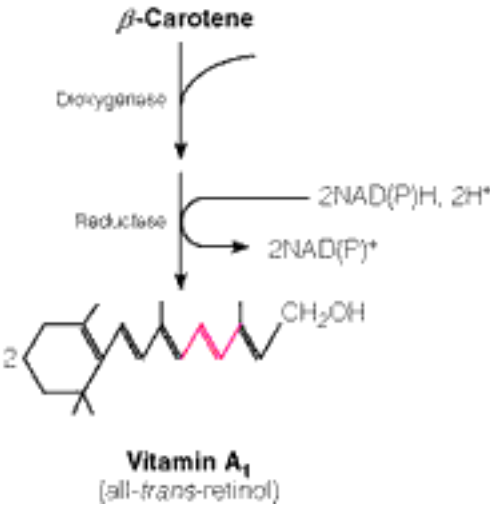

Lycopene

Lycopene is a terpenoid compound ([Figure 19.28](#)) that is a precursor of β -[carotene](#), a molecule which is broken down in animals to form [vitamin A](#).

See also: [Cholesterol Biosynthesis](#),

INTERNET LINK:
[Terpenoid Biosynthesis](#)

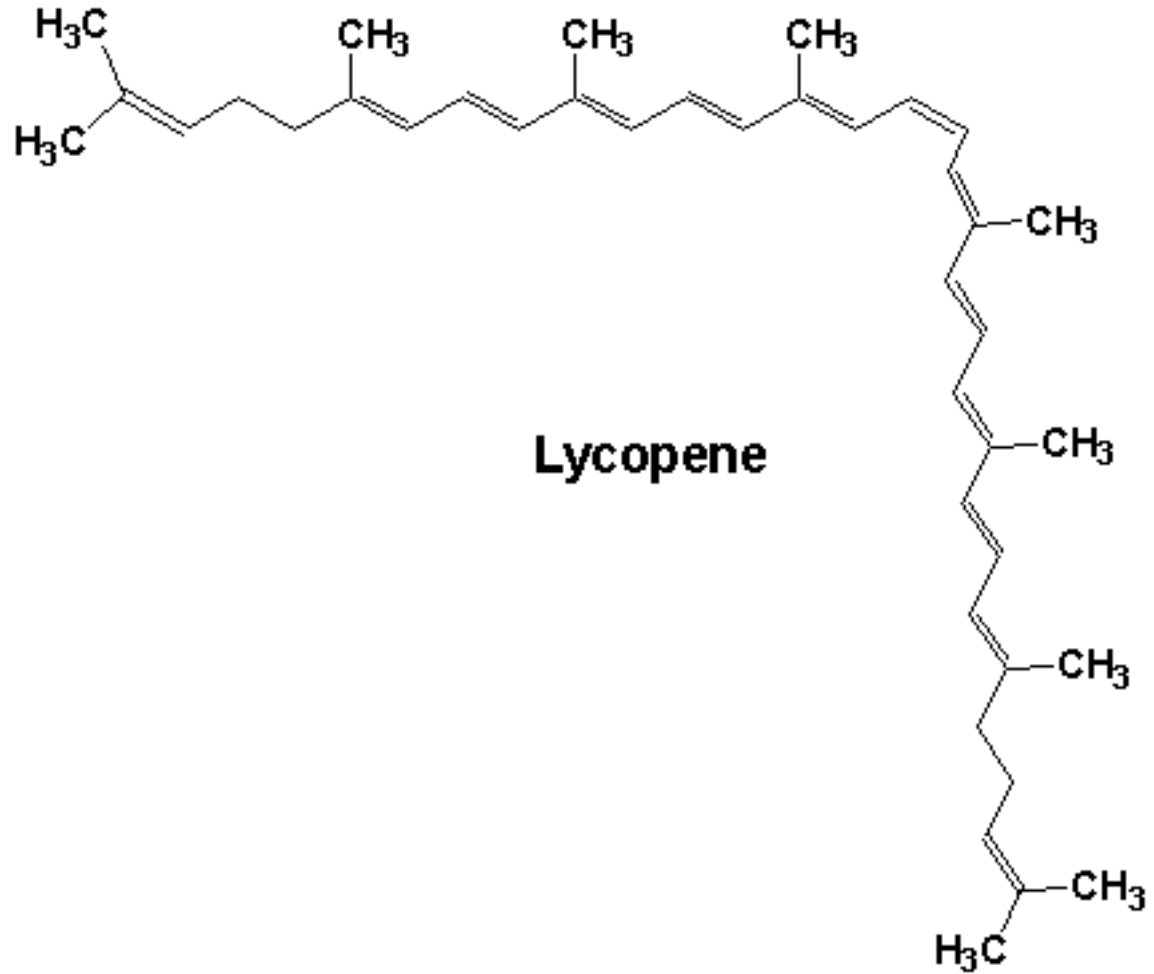
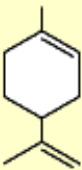
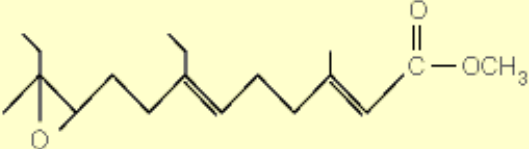
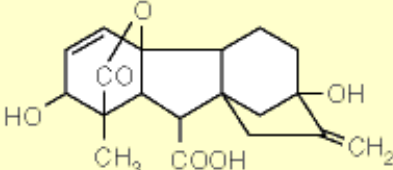
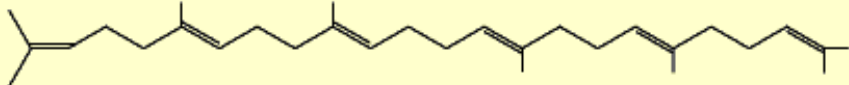
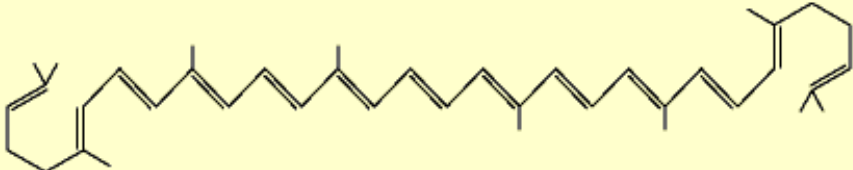
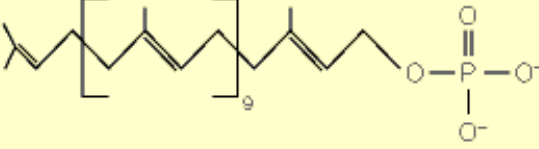
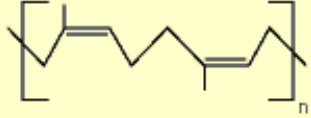
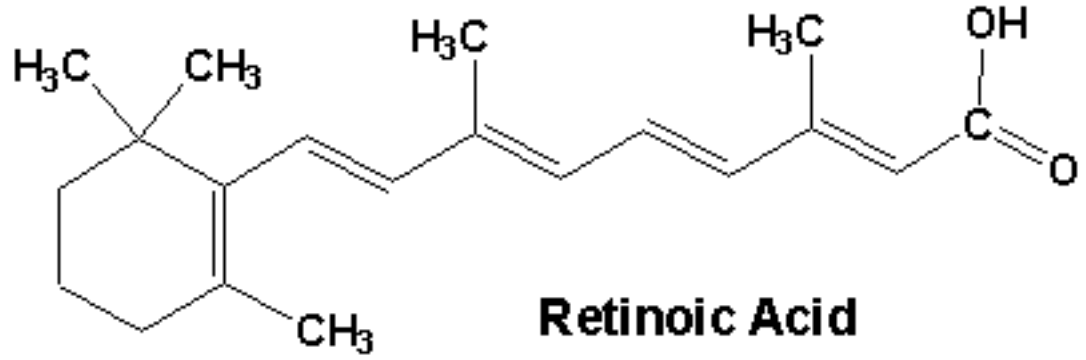

Figure 19.28: Some terpene compounds.

Class	Example	Function
Monoterpenes	 <p>Limonene</p>	Responsible for the characteristic odor of lemons
Sesquiterpenes	 <p>Juvenile hormone I</p>	Controls metamorphosis in insects
Diterpenes	 <p>Gibberellic acid</p>	Plant growth hormone
Triterpenes	 <p>Squalene</p>	Cholesterol precursor
Tetraterpenes	 <p>Lycopene</p>	Tomato pigment
Polyprenols	 <p>Undecaprenol phosphate</p>	Sugar carrier for oligosaccharide synthesis
	 <p>cis-Polyisoprene</p>	Natural rubber

Retinoic Acid

Retinoic acid is an oxidized derivative of **vitamin A** that functions in embryonic development.



See also: [β-Carotene](#), [Lipid-Soluble Vitamins](#), [Vitamins](#)

INTERNET LINKS:

1. [Retinol Metabolism](#)
 2. [Rod Photoreceptor](#)
-

Vitamins



Vitamins are organic molecules that are essential to the biological processes of higher organisms, but cannot be synthesized by these organisms. Examples include the fat-soluble **vitamins** A, D, E, and K and the water-soluble B complex **vitamins** and ascorbic acid, also known as **vitamin** C.

See also: [Lipid-Soluble Vitamins](#)

Vitamin D

The most abundant form of vitamin D is D₃, called cholecalciferol. Vitamin D is not technically a vitamin, because it is not required in the diet. It arises from uv-photolysis of [7-dehydrocholesterol](#), an intermediate in cholesterol biosynthesis (see [here](#)).

Vitamin D regulates calcium and phosphorus metabolism, particularly the synthesis of the inorganic matrix of bone, which consists largely of calcium phosphate.

D₃ undergoes two successive hydroxylations catalyzed by mixed-function oxidases. The first occurs at carbon 25 in liver. When calcium levels are low, hydroxylation occurs at carbon 1, yielding the active form, [1,25\(OH\)D₃](#), which stimulates osteoblasts to take up calcium. In the intestine, 1,25(OH)D₃ stimulates transcription of a protein that stimulates calcium absorption into the bloodstream. When calcium levels are adequate, hydroxylation occurs instead at carbon 24, yielding the inactive 24,25(OH)D₃ form.

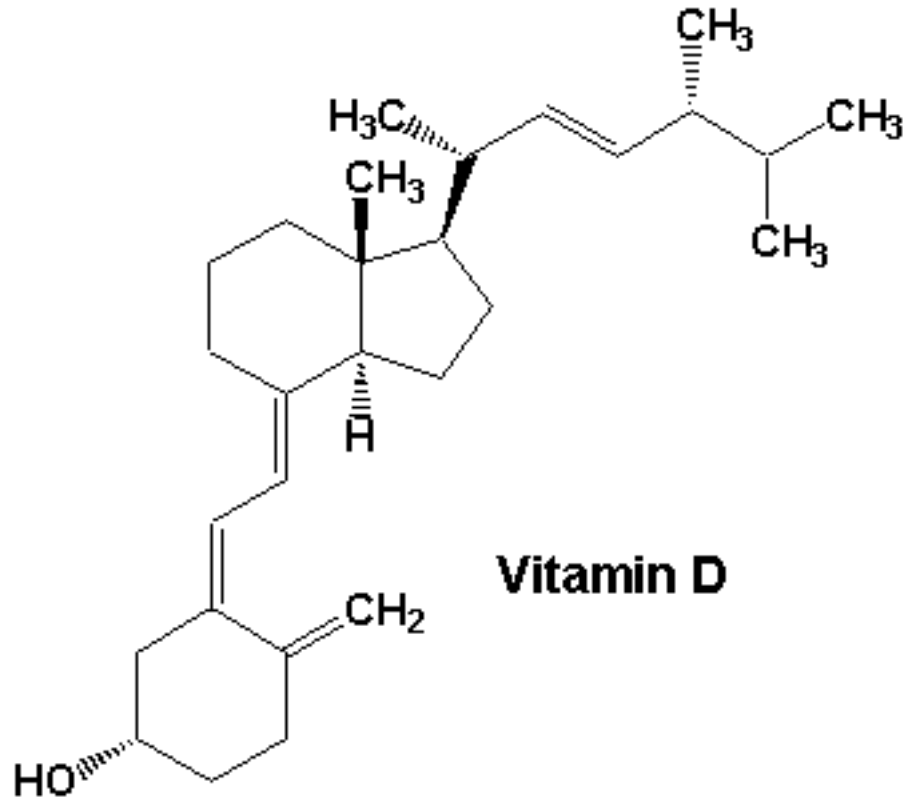

See also: [Lipid-Soluble Vitamins](#), [Steroid Metabolism](#), [Dimethylallyl Pyrophosphate](#), [Isopentenyl Pyrophosphate](#)

7-Dehydrocholesterol

7-**Dehydrocholesterol** is an intermediate from cholesterol biosynthesis that is a precursor of vitamin D3 ([cholecalciferol](#)).

See also: [Lipid-Soluble Vitamins](#), [Steroid Metabolism](#), [Dimethylallyl Pyrophosphate](#), [Isopentenyl Pyrophosphate](#), [Vitamin D](#)

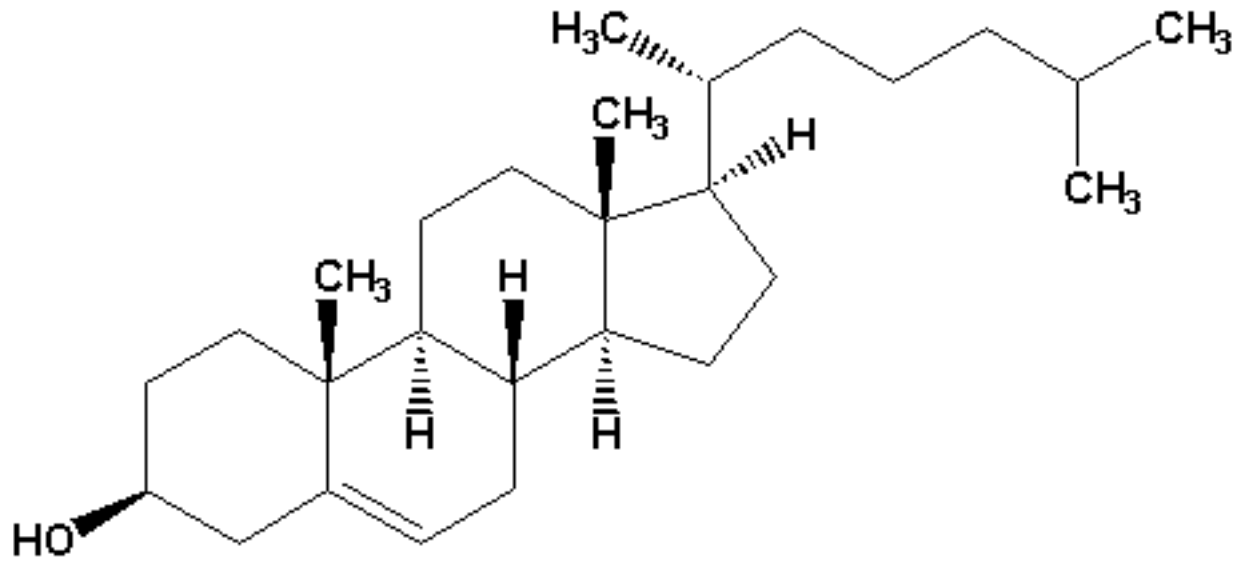

7-Dehydrocholesterol

Cholecalciferol

Cholecalciferol (vitamin D3) is the most abundant form of vitamin D. It arises from uv-photolysis of **7-dehydrocholesterol**, an intermediate in cholesterol biosynthesis (see [here](#)).

See also: [Lipid-Soluble Vitamins](#), [Steroid Metabolism](#), [Dimethylallyl Pyrophosphate](#), [Isopentenyl Pyrophosphate](#)

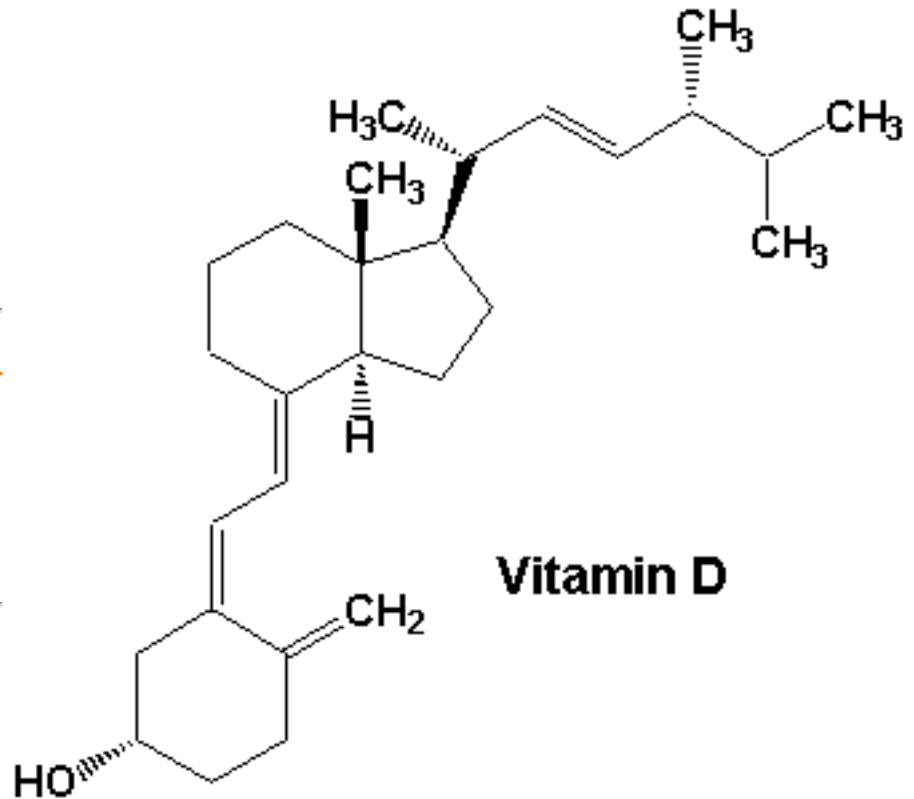

Unnumbered Item

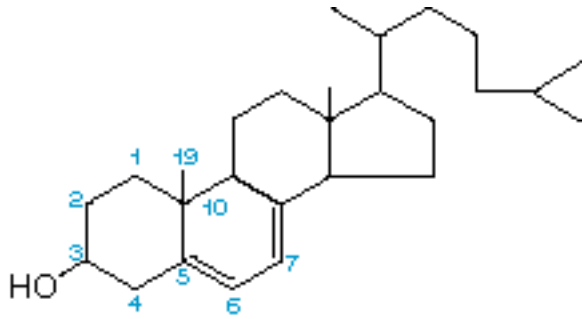

7-Dehydrocholesterol

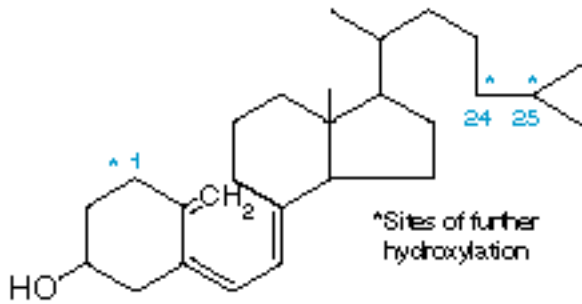

Cholecalciferol (vitamin D₃)

1,25 Dihydroxycholecalciferol - 1,25(OH)D₃

The most abundant form of **vitamin D** is **D₃**, called **cholecalciferol**. **Vitamin D** is not technically a vitamin, because it is not required in the diet. It arises from uv-photolysis of **7-dehydrocholesterol**, an intermediate in cholesterol biosynthesis (see [here](#)).

Vitamin D regulates calcium and phosphorus metabolism, particularly the synthesis of the inorganic matrix of bone, which consists largely of calcium phosphate.

D₃ undergoes two successive hydroxylations catalyzed by mixed-function oxidases. The first occurs at carbon 25 in liver. When calcium levels are low, hydroxylation occurs at carbon 1, yielding the active form, **1,25(OH)D₃**, which stimulates osteoblasts to take up calcium. In the intestine, **1,25(OH)D₃** stimulates transcription of a protein that stimulates calcium absorption into the bloodstream. When calcium levels are adequate, hydroxylation occurs instead at carbon 24, yielding the inactive **24,25(OH)D₃** form.

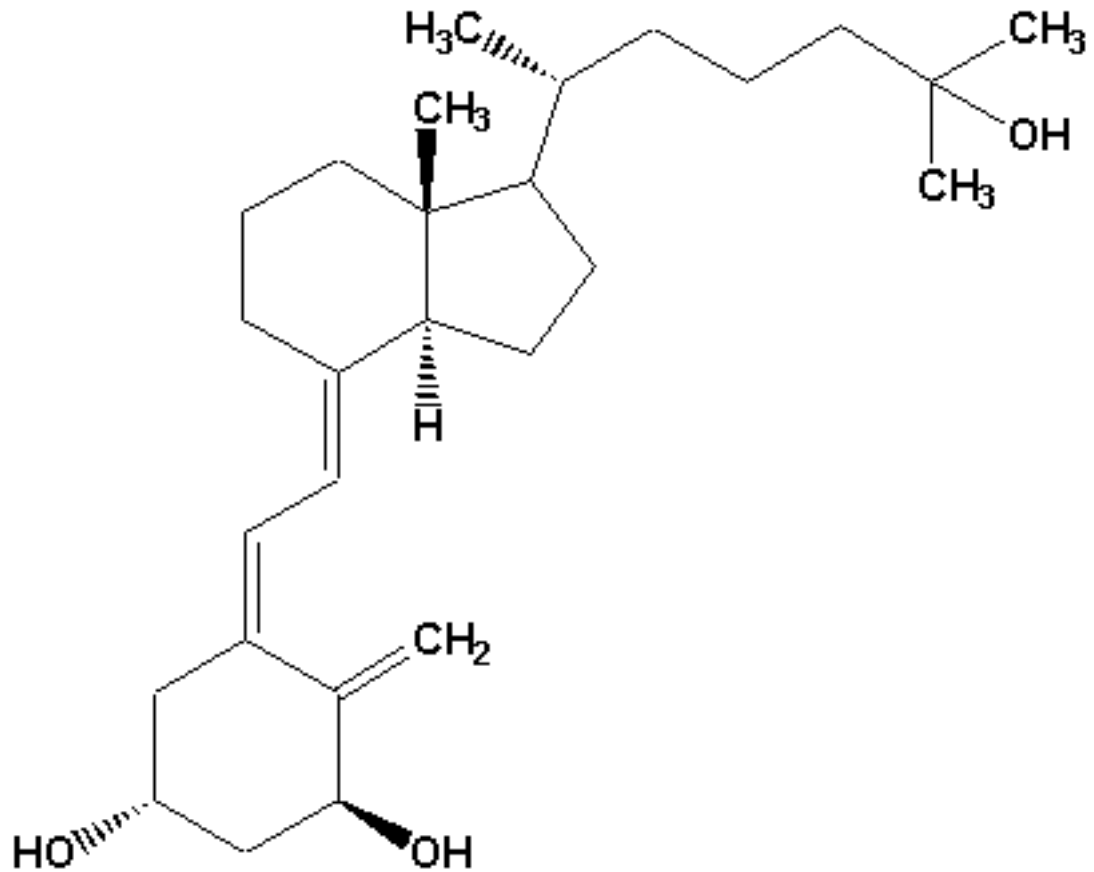

1,25-Dihydroxycholecalciferol

See also: [Lipid-Soluble Vitamins](#), [Steroid Metabolism](#), [Dimethylallyl Pyrophosphate](#), [Isopentenyl Pyrophosphate](#)

Vitamin E (α)

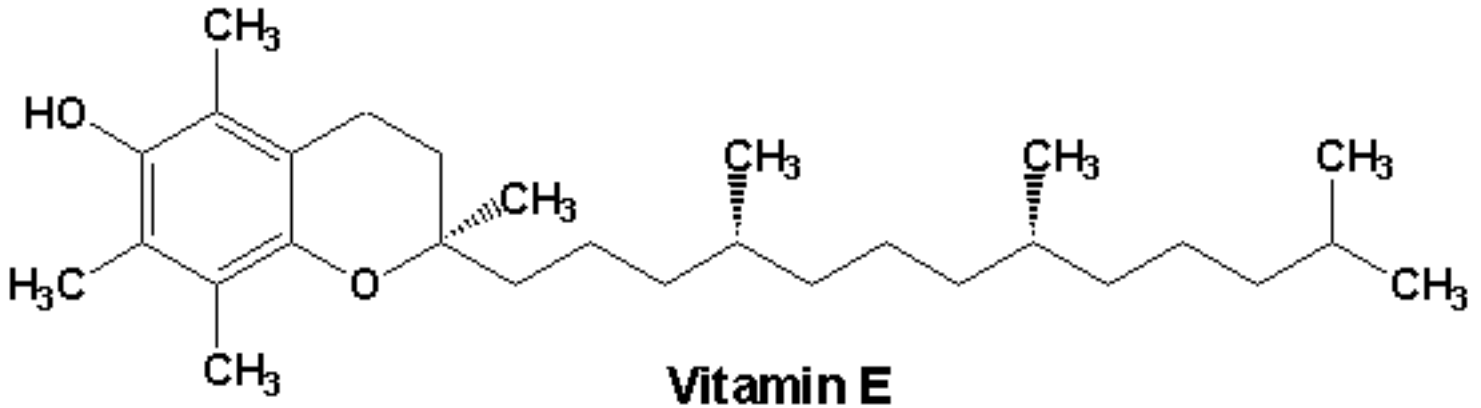

Vitamin E is a fat soluble vitamin that appears to protect against oxidative damage in cellular membranes. Vitamin E is also called α -tocopherol. Vitamin E is an antioxidant. It is particularly effective in preventing the attack of peroxides on unsaturated fatty acids in membrane lipids. Deficiency of vitamin E also leads to other symptoms, however, so vitamin E probably plays other roles as yet undiscovered.

See also: [Antioxidants](#), [Reactive Oxygen](#), [Oxygen Metabolism and Human Disease](#), [Vitamins](#), [Lipid-Soluble Vitamins](#)

Oxygen Metabolism and Human Disease

Oxidative damage has been implicated in as many as one hundred disease states, including cardiovascular disease, cancer, stroke, neurodegenerative diseases, and chronic inflammatory diseases. The health-promoting effects of diets rich in fresh fruits and vegetables probably result in large part from their high content of antioxidant compounds, particularly [vitamin C](#) and [vitamin E](#).

Generation of altered, **oxidized bases** in DNA, such as [8-oxoguanine](#) or [5-hydroxyuracil](#), and [thymine glycol](#) (see [here](#) also) is intensely mutagenic. The intracellular generation of reactive oxygen species causes the formation of DNA bases such as 8-oxoguanine (8-hydroxyguanine) or thymine glycol. 8-oxoguanine is the most significant product of oxidative DNA damage. One of the protective mechanisms is not a DNA repair enzyme, but a nucleotide hydrolase. In *E. coli*, 8-oxo-dGTP accumulates in oxygen-stressed cells, and an enzyme encoded by the mutT gene cleaves this altered nucleotide before it can be used as a DNA replication substrate:



A similar enzyme exists in mammalian cells.

Partly because cancer incidence is strongly correlated with age, many scientists also attribute normal aging to the accumulation of unrepaired mutagenic DNA lesions, and oxidative stress is implicated in what has been called the "free radical theory of aging."

Human mutations in the gene encoding the copper/zinc form of [superoxide dismutase](#) have been shown to cause amyotrophic lateral sclerosis, a neurodegenerative disorder better known as Lou Gehrig's disease.

The role of peroxynitrite in the nerve degeneration causing multiple sclerosis (MS) has been brought into focus with the observation that patients with gout hardly ever develop MS, suggesting that the chronic uric acid elevation causing gout also prevents the development of MS.

Mutations affecting the mitochondrially encoded subunits of cytochrome oxidase have been associated with Alzheimer's disease.

See also: [Reactive Oxygen](#), [Antioxidants](#), [Types and Consequences of DNA Damage](#) (from Chapter 25), [Uric Acid](#)

5-Hydroxymethyluracil

5-Hydroxymethyluracil is an altered base of DNA created by reaction with hydroxyl radicals. Other modified nucleotides resulting from similar reactions include [8-oxoguanine](#) and [thymine glycol](#).

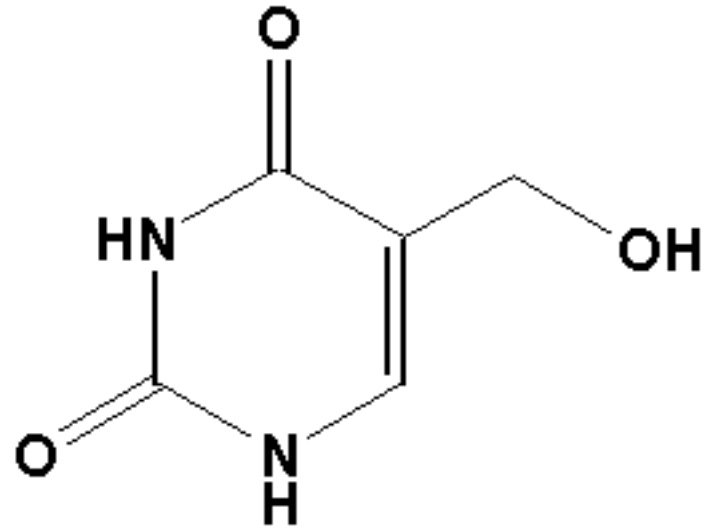

5-Hydroxymethyluracil

See also: [Antioxidants](#), [Reactive Oxygen](#), [Oxygen Metabolism and Human Disease](#), [DNA](#), [Nucleotides](#)

Thymine Glycol

Thymine glycol is an altered base of DNA created by reaction with hydroxyl radicals. Other modified nucleotides resulting from similar reactions include [8-oxoguanine](#) and [5-hydroxymethyluracil](#).

See also: [Antioxidants](#), [Reactive Oxygen](#), [Oxygen Metabolism and Human Disease](#), [DNA](#), [Nucleotides](#)

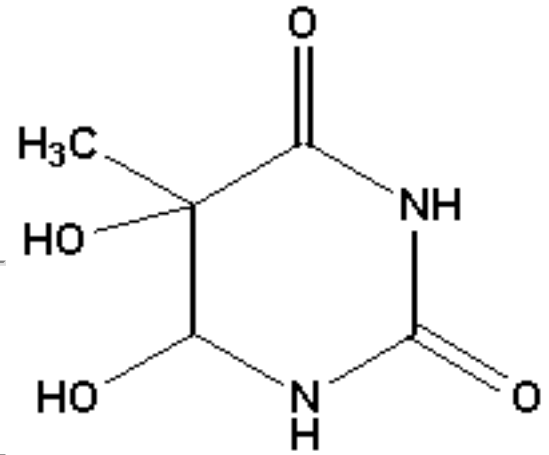

Thymine glycol

Unnumbered Item

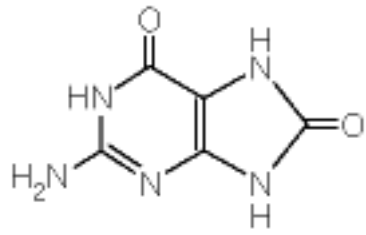

8-Oxoguanine

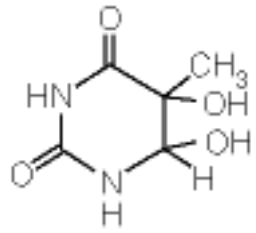

Thymine glycol

Superoxide Dismutase

Superoxide dismutases are a class of enzymes that catalyze reactions similar to the one below:

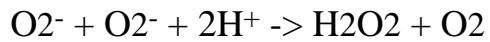

The term **dismutase** describes an enzyme that acts on two identical substrate molecules in a way that results in two different products. The hydrogen peroxide formed in the reaction above can be broken down by the enzyme catalase or, to some extent, by peroxidases.

See also: [Antioxidants](#), [Reactive Oxygen](#), [Oxygen Metabolism and Human Disease](#), [Catalase](#), [Glutathione Peroxidase](#)

Catalase

Catalase is a heme-iron-containing enzyme that catalyzes the reaction below:

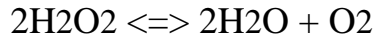

Catalase has an extremely high turnover rate (>40,000 molecules per second) and acts to protect against oxidative damage by the reactive oxygen species, H₂O₂.

See also: [Antioxidants](#), [Reactive Oxygen](#), [Oxygen Metabolism and Human Disease](#), [Catalase](#), [Glutathione Peroxidase](#), [Superoxide Dismutase](#)

Chemistry of Photoreception

In the eye, specialized photoreceptor cells of the retina, called rod cells are primarily responsible for low-light vision, with relatively little color detection. Rod cell outer segments contain lamellar protein disks rich in the protein opsin ([Figure 19.26](#)). Oxidation and isomerization of all-*trans*-retinol yields an intermediate, 11-*cis* retinal, which is important in photoreception. The chemistry of photoreception is shown in [Figure 19.27](#) (see [here](#) also) and summarized as follows.

1. 11-*cis*-retinal is linked to opsin via a Schiff's base to form [rhodopsin](#).
2. Absorption of light by the retinal portion of the complex isomerizes the *cis*-bond in 11-*cis* retinal to a *trans*-bond, forming an all-*trans* compound called bathorhodopsin.
3. Release of a proton yields metarhodopsin II
4. Hydrolysis yields opsin and [all-*trans* retinal](#).
5. Retinal isomerase converts all-*trans* retinal to [11-*cis* retinal](#).

At step 3 above, bathorhodopsin (activated form of rhodopsin) can activate [transducin](#) so that it binds [GTP](#). The transducin-GTP complex can bind to a specific phosphodiesterase that cleaves [cyclic GMP](#) to [GMP](#). This, in turn, stimulates a cascade of events that generates a visual signal to the brain.

See also: [Lipid-Soluble Vitamins](#), [Vitamin A](#), [G Proteins in Vision](#)

INTERNET LINKS: [Rod Photoreceptor](#)

G Proteins in Vision

Vision consists of the following processes (see [here](#)):

1. A photon of light stimulates the membrane receptor called rhodopsin, which is an abundant membrane protein in the outer segment of rod cells in the retina.
2. A photochemical change in the structure of [rhodopsin](#) causes it to activate the G protein called [transducin](#) so that it binds [GTP](#).
3. The transducin--GTP complex activates a specific phosphodiesterase, which cleaves a cyclic nucleotide, guanosine 3',5'-monophosphate (cyclic GMP, or [cGMP](#)).
4. Cleavage of cGMP, in turn, stimulates intracellular reactions that generate a visual signal to the brain.

Thus, the stimulated hydrolysis of cGMP is the visual analog of the stimulated synthesis of cAMP in β -adrenergic responses.

See also: [G Proteins and Signal Transduction](#), [Hormone Mechanisms of Action](#), [Guanylate Cyclase](#)

INTERNET LINKS:

1. [G Protein Receptor Coupled Database](#)
 2. [G Protein Coupled Receptors Point Mutation Database](#)
-

Unnumbered Item

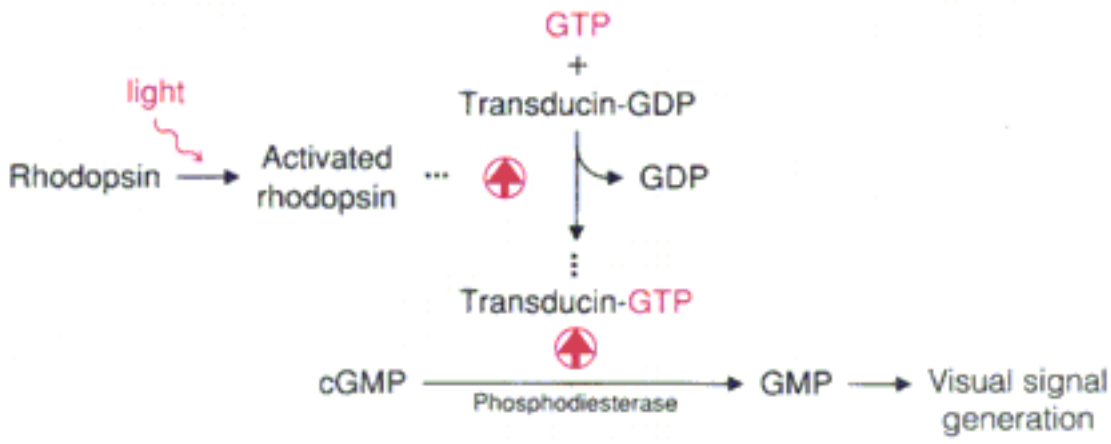

Hormone Mechanisms of Action

Hormonal mechanisms include the following:

1. Enzyme activation or inhibition via second messengers, as noted for [epinephrine](#) and [glucagon](#);
2. Stimulation of the synthesis of particular proteins, through activation of specific genes; and
3. Selective increases in the cellular uptake of certain metabolites. Among this last category are some receptors that serve directly as ion channels, with hormone binding causing a conformational change that opens the channel, and other receptors that stimulate uptake by still-unknown mechanisms, such as the effects of [insulin](#) upon glucose uptake.

Most hormones interacting with intracellular receptors exert their effects by controlling rates of transcription of specific genes. In this case, the hormone binds to a receptor and the complex migrates to the nucleus, where it interacts with specific DNA sites. Hormones in this class include [steroids](#), thyroid hormones (see [here](#)), and the hormonal forms of [vitamin D](#). In addition, retinoids, derived from retinoic acid (related to [vitamin A](#)), exert regulatory effects in embryonic development through interactions with intracellular receptors.

Mechanisms of hormones that act through membrane-bound receptors that interact with G proteins (see [here](#)) [Figure 12.13](#) or that have catalytic domains on the cytoplasmic side, are summarized in [Figure 23.7](#). The end result of most interactions between a hormone and a membrane receptor is activation of one or more protein kinases, whether or not a second messenger is involved. More than 100 different protein kinases have been described in vertebrate cells, all of them related, as determined by amino acid sequence homologies. More recent work is uncovering a host of specific protein phosphatases, also subject to control by cell signaling mechanisms.

See also: [Hormone Action](#), [Hormone Receptors](#), [Hormone Hierarchy of Action](#), [G Proteins and Signal Transduction](#)

Neurotransmitters and Receptors

There is great diversity in the types of neurotransmitters and their corresponding synapses. Some are rapid in action, others are slow. Nicotinic cholinergic synapses and those involving **glutamate** are stimulatory in nature and promote an action potential in the postsynaptic cell. Others, such as those using γ -aminobenzoic acid (**GABA**) as a transmitter are inhibitory. Impulses received at these synapses discourage transmission of an action potential in the recipient neuron. Inhibition can occur by the opening of chloride channels. Whether a neuron fires depends on the net summation of stimulatory and inhibitory inputs.

Acetylcholine can also bind to another receptor, called the muscarinic acetylcholine receptor. This receptor can be inhibitory, but not by the chloride channel mechanism. **Figure 21.36** shows a schematic representation of transmission and inhibition in a neural network.

Small peptides, such as somatostatin, neurotensin, and the enkephalins also act as neurotransmitters (**Table 21.2**). They may also act as neurohormones.

Some specialized synapses do not use neurotransmitters at all. These are gap junctions, which perform direct electrical-ionic conduction between neural cells.

Neurohormones affect the nervous system by modifying the way in which nerve cells respond to transmitters. Enkephalins and endorphins are small peptides that act as natural analgesics and bind to the same receptors as **morphine**.

Dopamine metabolism may be involved in addictive behavior. All addictive drugs have been shown to cause a surge in dopamine levels in the "reward" section of the brain, the *nucleus accumbens*. Glutamate receptors may also be involved in controlling addictive behavior.

See also: [**Biochemistry of Neurotransmission**](#), [**Neurotransmitters and Biological Regulators**](#)

INTERNET LINKS:

1. [**Neurotransmitter Receptors and Their Effects**](#)
 2. [**Neurotransmitter Newsletter**](#)
-

Action Potential

The **action potential** is a wave of transient depolarization that travels along the membrane of a nerve cell (or any other kind of excitable cell, such as a muscle cell) as a result of the movements of ions across the membrane. ([Figure 10.31](#)).

At the resting potential of a nerve cell, K^+ is much closer to its equilibrium distribution than is Na^+ . When the membrane becomes fully permeable to ions, there is a massive influx of sodium ions, with an accompanying shift in the membrane potentials toward $\Delta\psi_{Na^+}$.

This influx of sodium ions is what happens when an **action potential** is transmitted along a nerve ([Figure 10.32](#)). The action potential is generated and propagated because a small depolarization of the nerve cell membrane opens gated channels, allowing ions to flow through.

See also: [Neurotransmission](#), [Resting Potential](#)

Figure 10.31: The action potential.

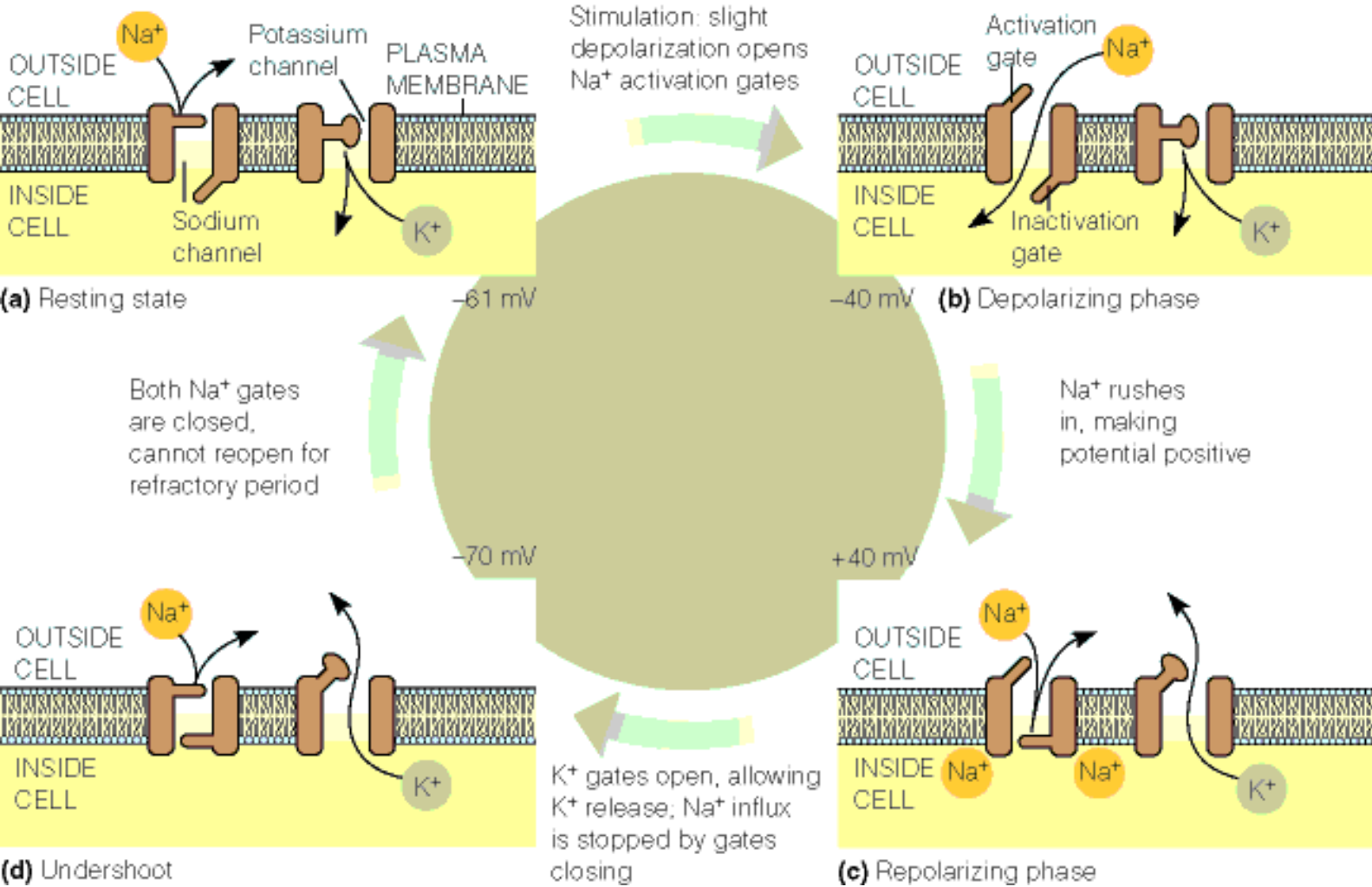

From Neil Campbell, Jane Reece, and Larry Mitchell, *Biology*, 5th ed. (Menlo Park, CA: Addison Wesley Longman, 1999). © Addison Wesley Longman, Inc.

Nicotine

Nicotine is an alkaloid from tobacco that can bind to nicotinic acetylcholine receptors (see [here](#)).

See also: [Neurotransmitters and Receptors](#),
[Neurotransmitters and Biological Regulators](#)

INTERNET LINKS:

1. [Neurotransmitter Receptors and Their Effects](#)
 2. [Neurotransmitter Newsletter](#)
-

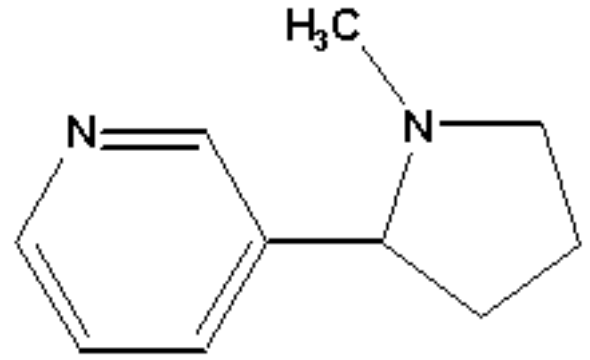

Nicotine

Figure 21.36: Transmission and inhibition in neural networks.

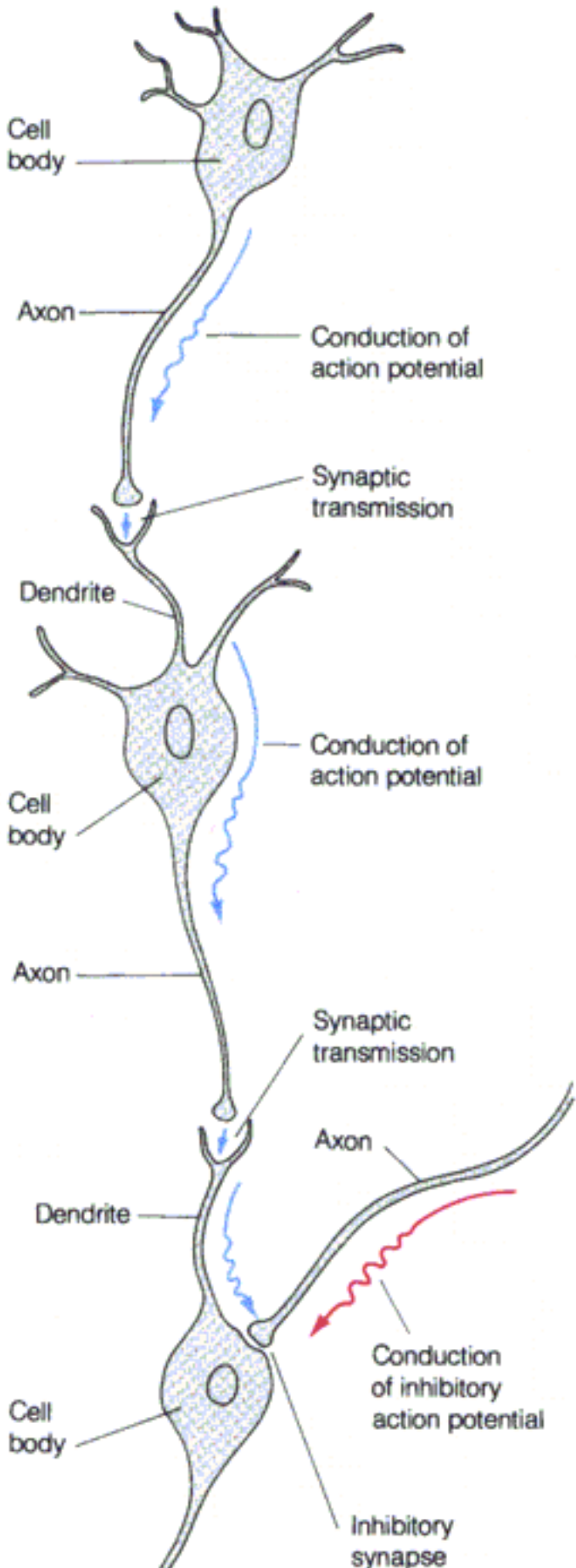

body

Inhibitory
synapse

**Inhibition
prevents further
transmission**

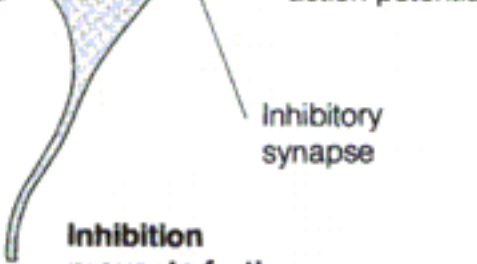

Table 21.2

Name	H/T	Sequence ^a
β -Endorphin	H	<u>YGG</u> EMTSFKSQTPLVTLFKNAIIKNAYKKGE
Met-enkephalin	H, T	<u>YGG</u> FM
Leu-enkephalin	H, T	<u>YGG</u> EL
Neurotensin	T	pELYENKPRRPYIL
Somatostatin	T	AGCKNFFWKTFTSC

^aThe subsequence YGGE, common to β -endorphin and the enkephalins, appears to be essential for their narcotic effects. The p at the N-terminal end of neurotensin signifies that the glutamate has been cyclized to the "pyro" form.

Morphine

Neurohormones affect the nervous system by modifying the way in which nerve cells respond to transmitters. Enkephalins and endorphins are small peptides that act as natural analgesics and bind to the same receptors as **morphine**.

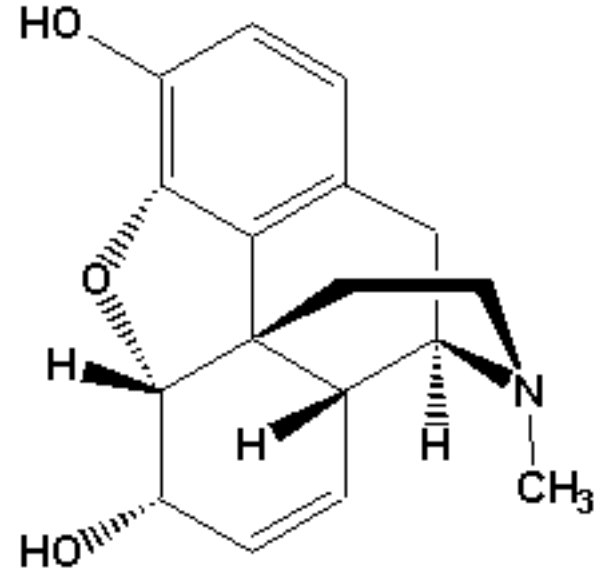

Morphine

See also: [Neurotransmitters and Receptors](#), [Biochemistry of Neurotransmission](#), [Neurotransmitters and Biological Regulators](#)

INTERNET LINKS:

1. [Neurotransmitter Receptors and Their Effects](#)
 2. [Neurotransmitter Newsletter](#)
-

Table 11.4

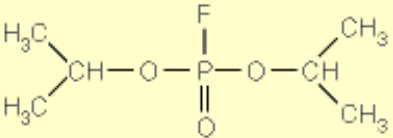
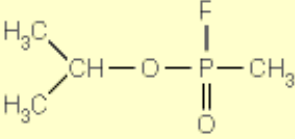
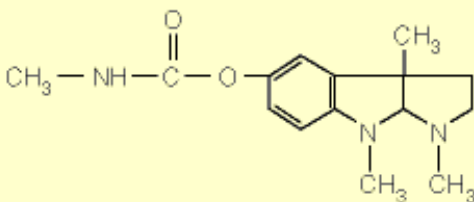
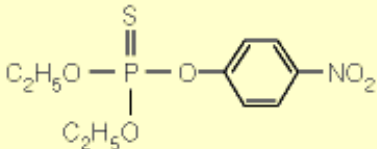
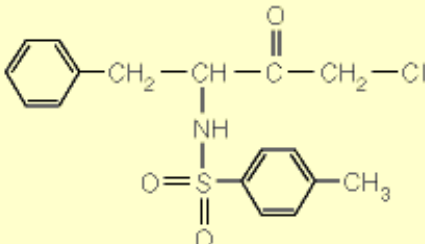
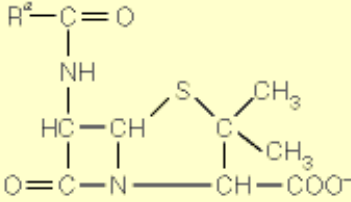
Name	Formula ^a	Source	Mode of Action
Cyanide	CN ⁻	Bitter almonds	Reacts with enzyme metal ions (i.e., Fe, Zn, Cu); respiratory chain enzymes are primary targets (see Chapter 15)
Diisopropyl fluorophosphate (DFP)		Synthetic	Inhibits enzymes with active site serine, including acetylcholinesterase
Sarin		Synthetic (nerve gas)	Like DFP
Physostigmine		Calabar beans	Like DFP
Parathion		Synthetic (insecticide)	Like DFP, but especially inhibitory to insect acetylcholinesterase
N-Tosyl-L-phenylalaninechloromethyl ketone (TPCK)		Synthetic	Reacts with His 57 of chymotrypsin
Penicillin		From <i>Penicillium</i> fungus	Inhibits enzymes in bacterial cell wall synthesis (see Chapter 16)

^aR = variable group; differs on different penicillins.

3,4-Dihydroxyphenylalanine (L-Dopa)

The importance of dopamine in neural transmission is emphasized by the number of major neurological diseases that are associated with improper dopamine regulation. The earliest indication of this type of defect was the finding that dopamine levels are abnormally low in a particular region of the brain of patients with Parkinsonism, a severe neurological disorder. Attempts to treat such patients with dopamine were futile, because after injection, dopamine does not cross the bloodbrain barrier. However, the dopamine precursor, **dopa**, does cross the bloodbrain barrier. For many individuals with Parkinsonism, daily doses of **dopa** have provided dramatic clinical improvement.

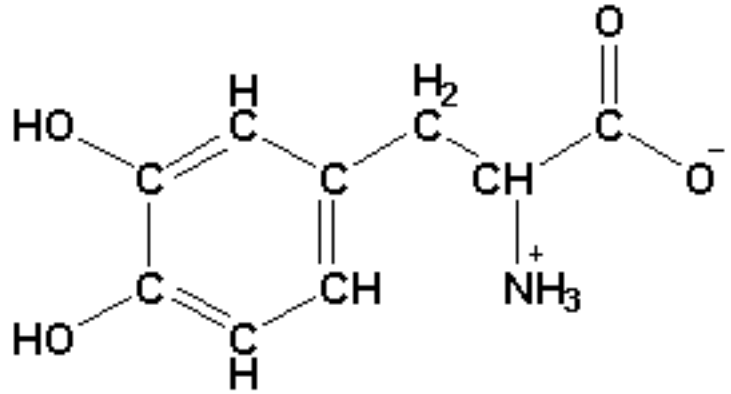

3,4-Dihydroxyphenylalanine (L-Dopa)

The biosynthetic pathway from tyrosine to **dopa**, and the other catecholamines is shown in [Figure 21.32](#).

See also: [Dopamine](#), [Neurotransmitters and Biological Regulators](#), [Biochemistry of Neurotransmission](#), [Tyrosine](#), [Catecholamines](#)

INTERNET LINK: [Dopamine](#)

Serotonin (5-Hydroxytryptamine)

Serotonin is a hormone that helps the body control satiety, the feeling of fullness after eating. The anti-obesity drug, **fenfluramine**, which acts by increasing **serotonin** levels and affecting the appetite, was becoming quite popular until it was found to do serious damage to the heart and was withdrawn from the market.

The metabolic biosynthetic pathway from tryptophan to **serotonin** is shown [here](#). **Serotonin** plays multiple roles in the nervous system, including neurotransmission. It is a precursor to **melatonin**, which is involved in regulation of sleepiness and wakefulness. In the intestine, **serotonin** regulates intestinal peristalsis. **Serotonin** is a potent vasoconstrictor, which helps regulate blood pressure.

The metabolic biosynthetic pathway from **tryptophan** to **serotonin** is shown [here](#).

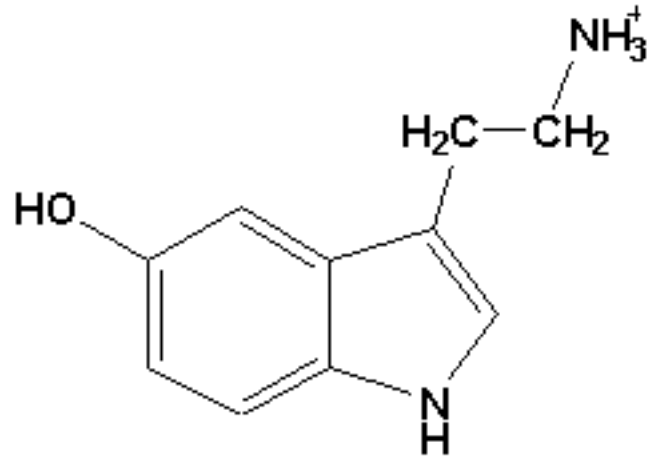

Serotonin (5-hydroxytryptamine)

See also: [Biochemistry of Obesity](#), [Leptin](#)

INTERNET LINKS:

1. [Neurotransmitter Receptors and Their Effects](#)
 2. [Neurotransmitter Newsletter](#)
-

Fenfluramine

Fenfluramine was a popular diet drug until it was discovered that it damaged heart valves.
Fenfluramine increases the amounts of serotonin, which gives the feeling of fullness after a meal.

See also: [Biochemistry of Obesity](#)

Biochemistry of Obesity

In mice, defects in the **ob gene** leads to mice with body weights as much as three times normal. The **ob gene** codes for a protein called leptin, which is normally synthesized in adipocytes and acts as a hormone, binding to a specific site in the brain. **Obese mice** lacking leptin eat as if perpetually starved. Conversely, injecting leptin into these mice causes them to lose weight dramatically. **Obese humans**, on the other hand, appear to contain high levels of leptin.

Serotonin controls the feeling of fullness after eating. The anti-obesity drug **fenfluramine** was originally prescribed because it increases serotonin levels, thus curbing appetite. It turned out, however, that fenfluramine also did but serious damage to the heart and has since been withdrawn from the market. Despite this setback, biochemical research on obesity is one of the most active current research frontiers.

See also: [Leptin](#)

Leptin

Leptin is the product of the "ob" gene, originally identified in abnormally obese mice. The gene acts as a hormone, binding to a specific site in the brain. **Leptin** appears to function in mice in sensing the amount of fat stored in adipocytes and controlling Feeding behavior appropriately. Mice lacking leptin become very fat from overeating. In humans, the function of **leptin** is less clear, as obese people frequently have large amounts of **leptin**.

See also: [Biochemistry of Obesity](#), [Serotonin](#)

Unnumbered Item

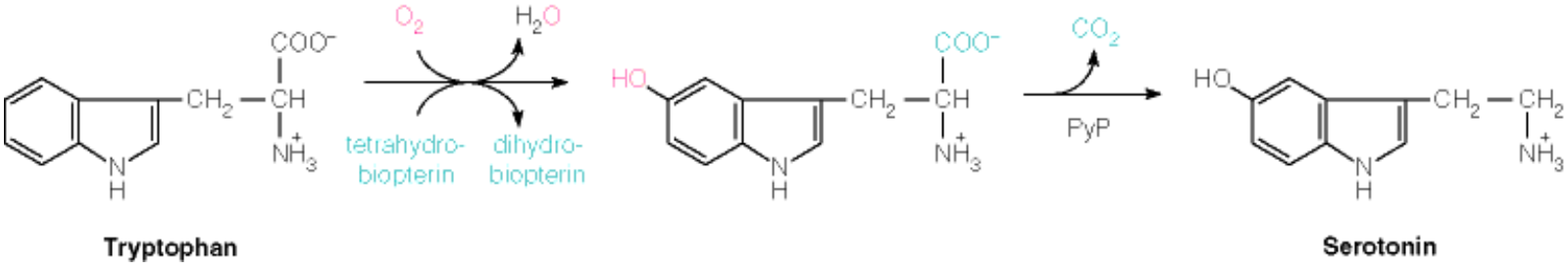

Melatonin (O-Methyl-N-Acetylserotonin)

Melatonin is a byproduct of [serotonin](#) that is involved in regulation of sleepiness and wakefulness.

See also: [Neurotransmitters and Biological Regulators](#)

[Biochemistry of Neurotransmission](#)

[Neurotransmitters and Receptors](#)

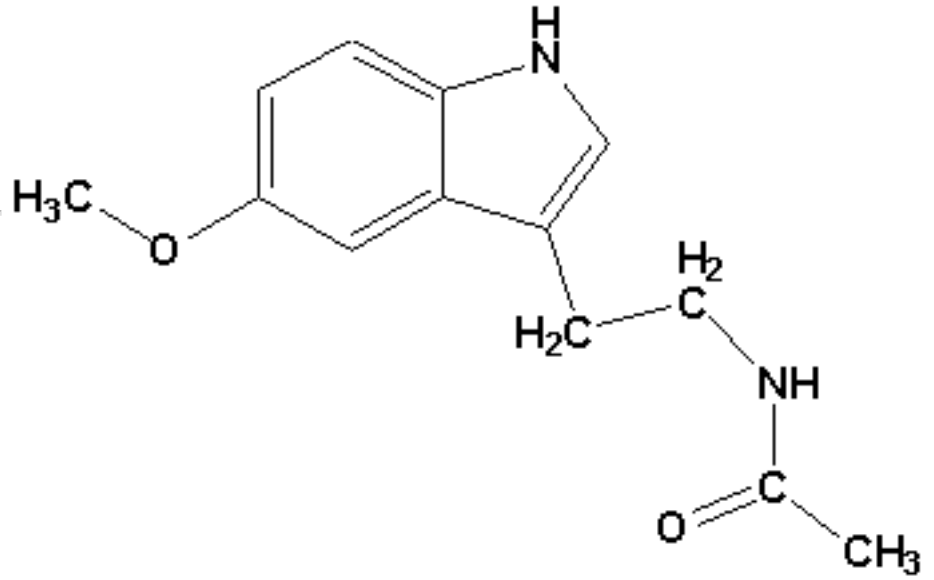

Melatonin (O-methyl-N-acetylserotonin)

Action of Insulin

Hormones are compounds secreted by specific tissues called endocrine glands ([Figure 23.6](#)). Endocrine glands secrete hormones directly into the bloodstream, so the response to a hormonal signal comes as a direct and rapid result of its secretion. [Insulin](#) is a 5.8-kilodalton protein hormone synthesized in the so-called B cells, which are endocrine cells in the pancreas.

Insulin promotes

1. Uptake of fuel substrates into some cells;
2. Storage of fuels ([lipids](#) and [glycogen](#)); and
3. Biosynthesis of macromolecules ([nucleic acids](#) and [protein](#)).

Because insulin promotes biosynthesis, **insulin** can be considered a growth hormone. Specific effects of **insulin** include the following:

1. Increased uptake of [glucose](#) in muscle and adipose tissue;
2. Activation of [glycolysis](#) in liver;
3. Increased synthesis of [fatty acids](#) and [triacylglycerols](#) in liver and adipose tissue;
4. Inhibition of [gluconeogenesis](#) in liver;
5. Increased [glycogen synthesis](#) in liver and muscle;
6. Increased uptake of [amino acids](#) into muscle with consequent activation of muscle protein synthesis; and
7. Inhibition of protein degradation.

Insulin stimulates [glucose](#) uptake into muscle and adipose cells, at least partly by translocating the glucose transporter (a membrane protein that carries out facilitated diffusion of glucose) from the cytosol (where it resides in the absence of insulin) to the cell surface, in response to **insulin**.

See also: [Pancreas Anatomy](#), [Action of Glucagon](#), [Action of Epinephrine](#), [Response to Starvation](#),

Diabetes, Insulin (from Chapter 13), Figure 23.2, Facilitated Diffusion

Lipids

Lipids are a class of nonpolar molecules that include the [fats](#), [cholesterol](#), [fatty acids](#), [lipid-soluble vitamins](#), waxes, soaps, [glycerophospholipids](#), [sphingolipids](#), and others. **Lipids** are found in the membranes of cells, the [endoplasmic reticulum](#), and in specialized fat storage cells called [adipocytes](#).

See also: [Adipocytes](#), [Endoplasmic Reticulum](#),

Adipocytes



Adipocytes are cells of the body involved in storage of fat.

See also: [Energy Storage](#), [Triacylglycerol Synthesis](#), [Biochemistry of Obesity](#), [Lipids](#)

Pancreas Anatomy

The **pancreas** contains endocrine cells, which secrete hormones directly into the bloodstream, and exocrine cells, which secrete zymogen precursors of digestive enzymes into the upper small intestine. The endocrine tissue contains cell clusters known as islets of Langerhans, which contain at least four different cell types (A, D, P, and B), each specialized for synthesis of one hormone. The A cells produce **glucagon**; the D cells, **somatostatin**; and the P cells, a recently discovered pancreatic hormone. **Insulin** is synthesized in the B cells, which sense **glucose** levels and secrete insulin in response to increased levels of blood glucose.

See also: **Action of Insulin**, **Action of Glucagon**

Action of Glucagon

Hormones are compounds secreted by specific tissues called endocrine glands ([Figure 23.6](#)). Endocrine glands secrete hormones directly into the bloodstream, so the response to a hormonal signal comes as a direct and rapid result of its secretion. **Glucagon** is a 3.5-kilodalton polypeptide hormone synthesized by the A cells of the islets of Langerhans in the pancreas. These endocrine cells sense the blood [glucose](#) concentration and release **glucagon** in response to low levels (see [Figure 23.2](#) and [Table 23.1](#)). Both synthesis and release of **glucagon** are controlled by [insulin](#).

In the liver, **glucagon** increases [cyclic AMP](#) (cAMP) levels, as schematized in [Figure 23.3](#). The resultant metabolic cascades, discussed in Chapters 13 ([here](#)) and 16 ([here](#)), promote [glycogenolysis](#) and inhibit [glycogen synthesis](#). In addition, by activating the hydrolysis of [fructose-2,6-bisphosphate](#), cAMP inhibits [glycolysis](#) and activates [gluconeogenesis](#) (see [here](#)).

Glucagon brings about the inhibition of [pyruvate kinase](#) (PK) in the liver, causing [phosphoenolpyruvate](#) (PEP) to accumulate. The level of [pyruvate](#) decreases, both because its synthesis from PEP is blocked and because it continues to be converted to PEP, via the [pyruvate carboxylase](#) and [phosphoenolpyruvate carboxykinase](#) reactions. Accumulation of PEP promotes [gluconeogenesis](#), while the inhibition of pyruvate kinase diminishes the [glycolytic](#) flux rate.

Glucagon also raises cAMP levels in adipose tissue. There the chief effect of cAMP is to promote triacylglycerol mobilization via phosphorylation of [hormone-sensitive lipase](#), yielding [glycerol](#) and [fatty acids](#).

See also: [Pancreas Anatomy](#), [Glycogen Regulatory Cascade](#) (from Chapter 13), [Action of Insulin](#), [Action of Epinephrine](#), [Response to Starvation](#)

Figure 23.2: Aspects of the control of blood glucose levels by pancreatic secretion of insulin and glucagon.

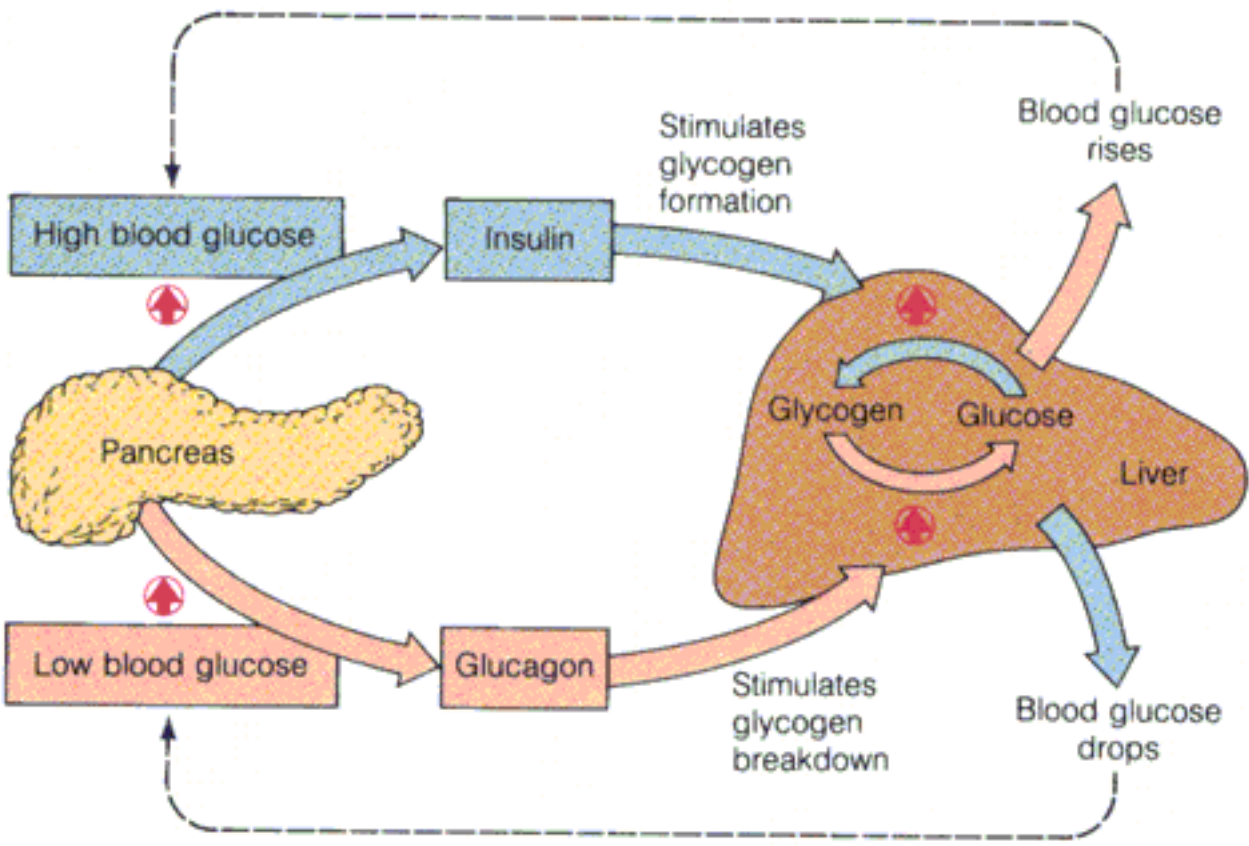
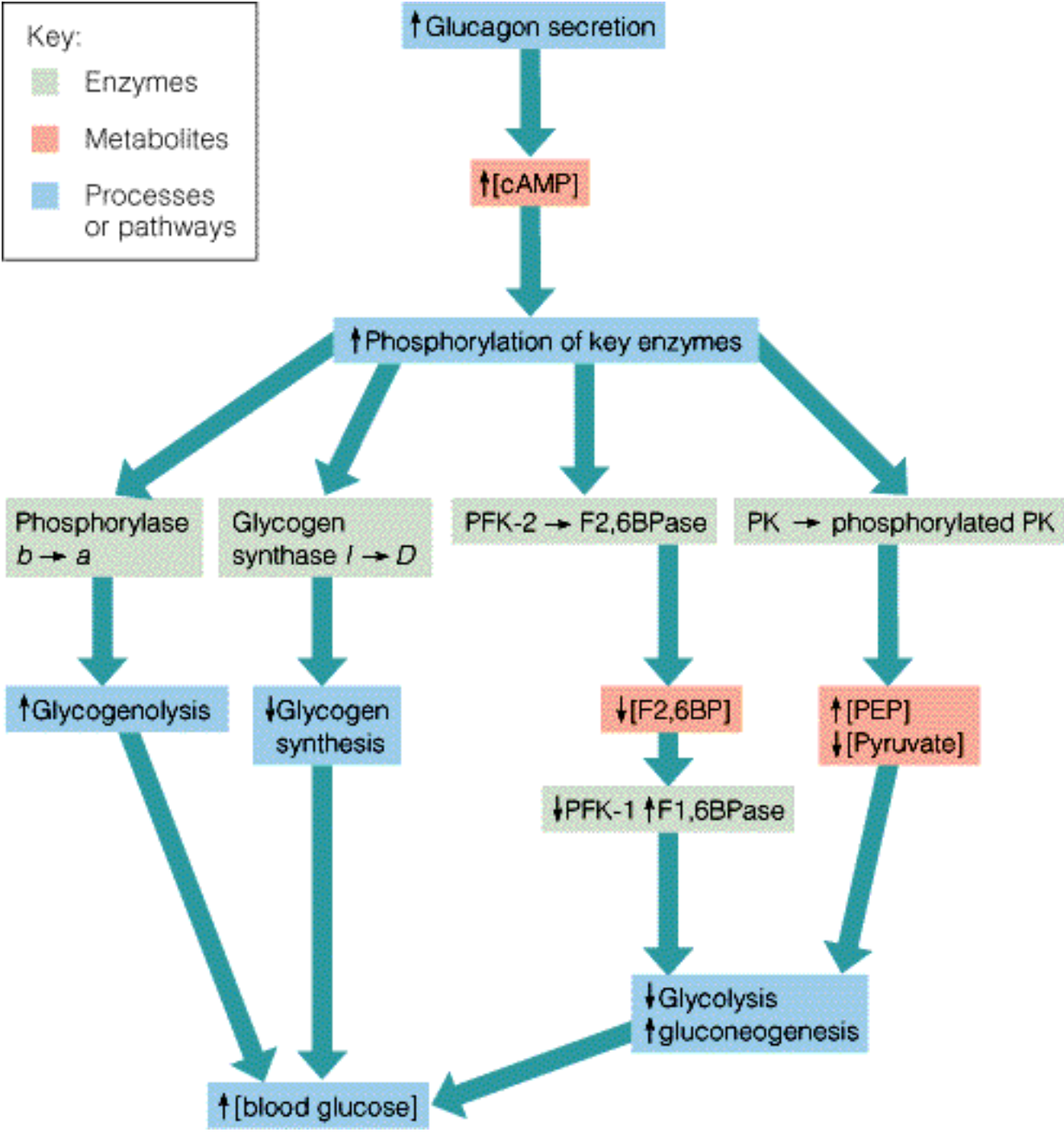

Table 23.1



Tissue	Fuel Store	Preferred Fuel	Fuel Sources Exported
Brain	None	Glucose (ketone bodies during starvation)	None
Skeletal muscle (resting)	Glycogen	Fatty acids	None
Skeletal muscle (during exertion)	None	Glucose	Lactate, alanine
Heart muscle	None	Fatty acids	None
Adipose tissue	Triacylglycerols	Fatty acids	Fatty acids, glycerol
Liver	Glycogen, triacylglycerols	Amino acids, glucose, fatty acids	Fatty acids, glucose, ketone bodies

Figure 23.3: Actions of glucagon in liver that lead to a rise in blood glucose.



Mechanism of Activating Glycogen Breakdown

Glycogen mobilization is controlled hormonally by a metabolic cascade that is activated by cAMP formation and involves successive phosphorylations of enzyme proteins ([Figure 13.18](#))

1. [Glucagon](#) or [epinephrine](#) interacts with a cellular receptor, which sends a signal via a G protein to the membrane-bound enzyme, adenylate cyclase.
2. [Adenylate cyclase](#), in turn, forms [cAMP](#) from ATP.
3. cAMP activates [cAMP-dependent protein kinase](#).
4. cAMP-dependent protein kinase phosphorylates [phosphorylase b kinase](#).
5. Phosphorylase b kinase phosphorylates [glycogen phosphorylase b](#) (the inactive form) to convert it to glycogen phosphorylase a (the active form).
6. [Glycogen phosphorylase a](#) catalyzes phosphorolysis of [glycogen](#) to form [glucose-1-phosphate](#).

Glycogen breakdown is reciprocally regulated with glycogen synthesis as follows:

cAMP exerts two effects in inhibiting glycogen synthesis: (1) phosphorylation of [glycogen synthase](#) (the enzyme that makes glycogen), inactivating it in the process, and (2) inhibition of [phosphoprotein phosphatase \(PP-1\)](#), whose activity tends to restore the activity of glycogen synthase. PP-1 and other phosphoprotein phosphatases play converse roles in glycogenolysis, in which dephosphorylation of glycogen phosphorylase b kinase causes its inactivation.

See also: [Action of glucagon](#) (from Chapter 23), [Glycogen Breakdown Regulation](#), [Glycogen Breakdown](#), [Kinase Cascade](#), [Reciprocal Regulation of Glycogen Biosynthesis and Mobilization](#) (from Chapter 16)

Glycogen Breakdown Regulation

Glycogen breakdown (and synthesis) is regulated by hormones.

Epinephrine (also called adrenalin) and **glucagon** stimulate **breakdown**. Insulin stimulates **synthesis**.

Breakdown occurs as a result of a **kinase cascade** that arises from binding of the appropriate hormone to the appropriate cell surface receptor. Recall that a regulatory cascade is a process in which the intensity of an initial regulatory signal is amplified manyfold through a series of enzyme activations.

The cascade depicted in **Figure 13.18** provides a way for cells to rapidly turn on **glycogen breakdown** and release of glucose. This is useful in emergency situations (e.g., the need to catch prey or the need to avoid being caught).

See also: **Reciprocal Regulation of Glycogen Biosynthesis and Mobilization** (from Chapter 16)

Fructose-2,6-Bisphosphate and Gluconeogenesis Regulation

The most potent allosteric regulator of the **glycolysis** and **gluconeogenesis** pathways is **fructose-2,6-bisphosphate (F2,6BP)**. As shown in **Figure 16.6**, **F2,6BP** activates phosphofructokinase (also called **PFK1**) - the enzyme in glycolysis that converts fructose-6-phosphate to fructose-1,6-bisphosphate. **F2,6BP** also inhibits fructose-1,6-bisphosphatase (**F1,6BPase**) - the enzyme in gluconeogenesis that accomplishes the opposite reaction. In fact, F1,6BP is ten times more sensitive to **F2,6BP** than **AMP**, another reciprocal regulator. The complex regulatory system involving **F2,6BP** is shown in **Figure 16.7**.

A single polypeptide contains both of the activities necessary to synthesize and degrade **F2,6BP**. The synthetic activity is called phosphofructokinase-2 (**PFK2**). To distinguish PFK2 from phosphofructokinase (the glycolysis enzyme), the latter enzyme is sometimes called PFK1. The catalytic activity that breaks down **F2,6BP** is referred to as fructose-2,6-bisphosphatase (**F2,6BPase**). Interconversion of PFK2 and F2,6BPase is accomplished by a **cAMP**-stimulated phosphorylation of PFK2 (by **cAMP-dependent protein kinase**) to form F2,6BPase.

Thus, in the presence of cAMP (which is produced in response to glucagon or epinephrine action), destruction of **F2,6BP** is favored. Because PFK1 is stimulated by **F2,6BP**, but F1,6BPase (the corresponding gluconeogenesis enzyme) is inhibited by **F2,6BP**, cAMP produced by glucagon or epinephrine will turn off glycolysis and turn on gluconeogenesis. Thus, due to hormonal control of F2,6BP, glycolysis and gluconeogenesis respond rapidly to hormonal regulation.

Summary

1. F2,6BP activates PFK1 (glycolysis) and inhibits F1,6BPase (gluconeogenesis)
2. PFK2 makes F2,6BP from F6P
3. F2,6BPase breaks down F2,6BP to F6P
4. PFK2 is converted to F2,6BPase by cAMP-dependent protein kinase by phosphorylation (requires cAMP - stimulated by glucagon or epinephrine)
5. F2,6BPase is converted back to PFK2 in absence of cAMP

So, when **epinephrine** or **glucagon** stimulates cells -> cAMP is produced ->cAMP-dependent protein kinase is activated -> PFK2 is converted to F2,6BPase ->F2,6BP is broken down -> Fructose 1,6-bisphosphatase (gluconeogenesis) is activated and PFK1 (glycolysis) is inhibited.

In the absence of epinephrine/glucagon stimulation (or with **insulin** stimulation), cAMP is broken down -
> cAMP-dependent protein kinase is inactivated -> F2,6BPase is converted to PFK2 -> F2,6BP is made -
> PFK1 (glycolysis) is stimulated and fructose-1,6-bisphosphatase (gluconeogenesis) is inhibited.

See also: [Regulation of Gluconeogenesis](#), [Reciprocal Regulation](#)

Action of Epinephrine

Epinephrine and **norepinephrine** are **catecholamines** which, when released from presynaptic nerve endings, function as neurotransmitters (see [here](#)). When released from adrenal medulla in response to low blood glucose levels, **epinephrine** interacts with second-messenger systems in many tissues, with varied effects. In muscle, **epinephrine** activates **adenylate cyclase**, with concomitant activation of **glycogenolysis** and inhibition of **glycogen synthesis**.

Triacylglycerol breakdown in adipose tissue is also stimulated by **epinephrine**, providing fuel for the muscle tissue. In consequence, glucose uptake into muscle is diminished, contributing to an increase in blood **glucose** levels.

Epinephrine also inhibits **insulin** secretion and stimulates **glucagon** secretion. These effects tend to increase glucose production and release by the liver. The net result is to increase blood glucose levels.

Unlike glucagon, the catecholamines have short-lived metabolic effects. **Epinephrine** action on skeletal and heart muscle cells is a crucial part of the "fight or flight" response.

See also: [Action of Insulin](#), [Action of Glucagon](#), [Hormonal Regulation of Fuel Metabolism](#), [Neurotransmitters and Biological Regulators](#)

Hormonal Regulation of Fuel Metabolism

Animals must maintain blood glucose levels within rather narrow limits to ensure proper functioning of the nervous system. The liver plays a major role in this process.

The amounts of [glucose](#) available to the blood vary with the nutritional status. In response to dietary glucose, homeostatic mechanisms come into play to promote uptake of glucose into cells and its use by tissues, thereby lowering glucose in the blood. When glucose levels fall, several hours after a meal, other mechanisms promote both glucose release, from intracellular [glycogen](#) stores, and [gluconeogenesis](#), so that the normal level is maintained. Some of the homeostatic mechanisms are regulated **hormonally**.

The most important **hormone** promoting glucose uptake and use is [insulin](#), whereas both [glucagon](#) and [epinephrine](#) act conversely, to increase blood glucose levels. The major effects of these agents are summarized in [Table 23.2](#).

[Figure 23.2](#) illustrates the interplay between insulin and glucagon.

See also: [Action of Insulin](#), [Action of Glucagon](#), [Action of Epinephrine](#), [Response to Starvation](#), [Diabetes](#), [Hormone Action](#), [Hormone Hierarchy of Action](#)

Table 23.2



Hormone	Biochemical Actions	Physiological Actions
Insulin	<ul style="list-style-type: none"> ↑ Cell permeability to glucose (in muscle and adipose tissue) ↑ Glycolysis ↑ Glycogen synthesis ↑ Triacylglycerol synthesis ↓ Gluconeogenesis ↓ Lipolysis ↓ Protein degradation ↑ Protein, DNA, and RNA synthesis 	<ul style="list-style-type: none"> Signals fed state ↓ Blood glucose level ↑ Fuel storage ↑ Cell growth and differentiation
Glucagon	<ul style="list-style-type: none"> ↑ cAMP level in liver and adipose tissue ↑ Glycogenolysis ↓ Glycogen synthesis ↑ Triacylglycerol hydrolysis ↑ Gluconeogenesis ↓ Glycolysis 	<ul style="list-style-type: none"> ↑ Glucose release from liver ↑ Blood glucose level
Epinephrine	<ul style="list-style-type: none"> ↑ cAMP level in muscle ↑ Triacylglycerol mobilization ↑ Glycogenolysis ↓ Glycogen synthesis 	<ul style="list-style-type: none"> ↑ Glucose release from liver ↓ Glucose use by muscle ↑ Blood glucose level

Response to Starvation

A 70-kg human can store at most the equivalent of 6700 kJ of energy as [glycogen](#). This source of blood [glucose](#) will be exhausted just a few hours after a meal. Because it is critical for brain function that blood glucose levels be maintained near 4.4 mM, the organism adapts metabolically during **starvation** to increase the use of fuels other than carbohydrate.

About 565,000 kJ is stored in the body as [triacylglycerol](#), largely in adipose tissue, and 100,000 kJ as mobilizable [proteins](#), largely in muscle. These stores provide sufficient energy to permit survival for up to several months, but the compounds must be modified to be of use.

Triacylglycerol mobilization generates energy largely as [acetyl-CoA](#), whose further oxidation in the [citric acid cycle](#) requires oxaloacetate. [Oxaloacetate](#) and other citric acid cycle intermediates are used in other metabolic reactions and must be replenished via anaplerotic pathways. The most important of these processes is the [pyruvate carboxylase](#) reaction, with most of the [pyruvate](#) coming from carbohydrate catabolism. During carbohydrate limitation, citric acid cycle intermediates can be provided from [glycerol](#) released from fat digestion, but glycerol is not produced in amounts adequate to maintain levels of citric acid cycle intermediates. Alternatively, these intermediates can be produced from protein catabolism and transamination. Consequently, proteolysis is accelerated during the first few days of **starvation**, because [amino acids](#) for protein synthesis are not present in sufficient amounts to counterbalance protein breakdown, which continues at normal rates. A major fate of the released amino acids is [gluconeogenesis](#). During this time, the liver and muscle are shifting to fatty acids as the dominant fuels for their own use.

Because fat breakdown has been activated, both acetyl-CoA and reduced electron carriers accumulate in the liver to the point that the acetyl-CoA cannot all be oxidized (see [here](#)). [Ketone bodies](#) then begin to accumulate. Accumulation of [acetoacetate](#) and β -[hydroxybutyrate](#) favors reactions that catabolize these ketone bodies. Thus, the brain adapts to reduced glucose levels by increasing the use of ketone bodies as alternative energy substrates. This trend continues for the duration of **starvation**. The metabolic changes accompanying **starvation** compromise the organism's abilities to respond to further stresses, such as extreme cold or infection. However, the adaptations do allow life to continue for many weeks without food intake, the total period being determined largely by the size of the fat deposits.

See also: [Maintaining blood glucose levels](#)

Unnumbered Item

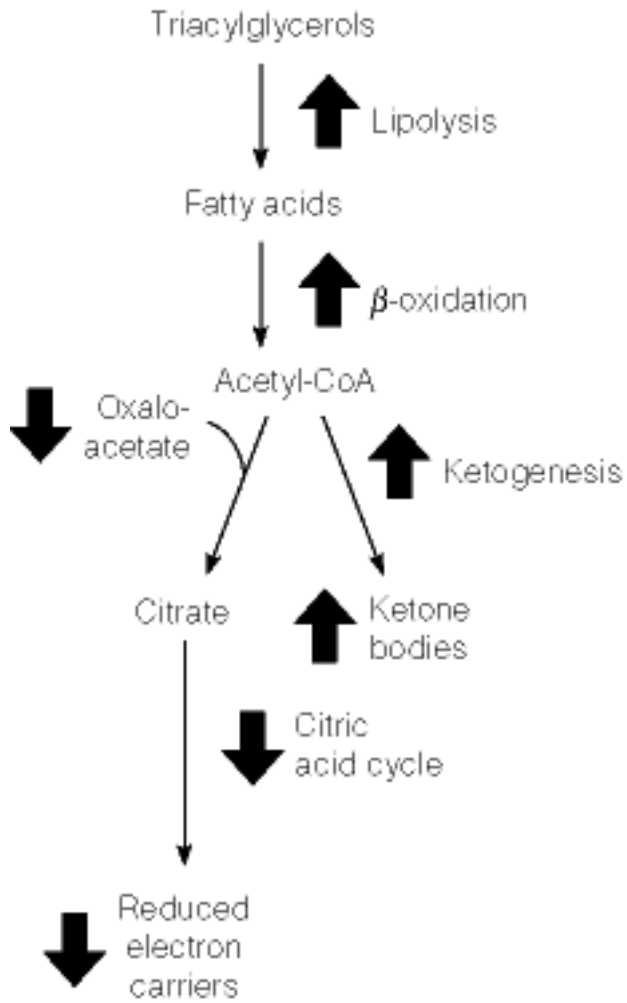

Key:
Increased (↑) and decreased (↓)
flux during starvation.

Lipoprotein Lipase (LPL)

Lipoprotein lipase is an enzyme found in the capillaries that catalyzes the hydrolysis of triacylglycerols in chylomicrons to glycerol and fatty acids ([Figure 18.6](#), [Figure 18.7](#)). **Lipoprotein lipase** is activated by apoprotein [C-II](#), which is found in all of the lipoprotein complexes except LDLs. Apoprotein [C-1](#) may also be involved in activation of **lipoprotein lipase**.

See also: [Tricylglycerol](#), [Lipoprotein Complexes](#), ,

Figure 18.6: Binding of a chylomicron to lipoprotein lipase on the inner surface of a capillary.

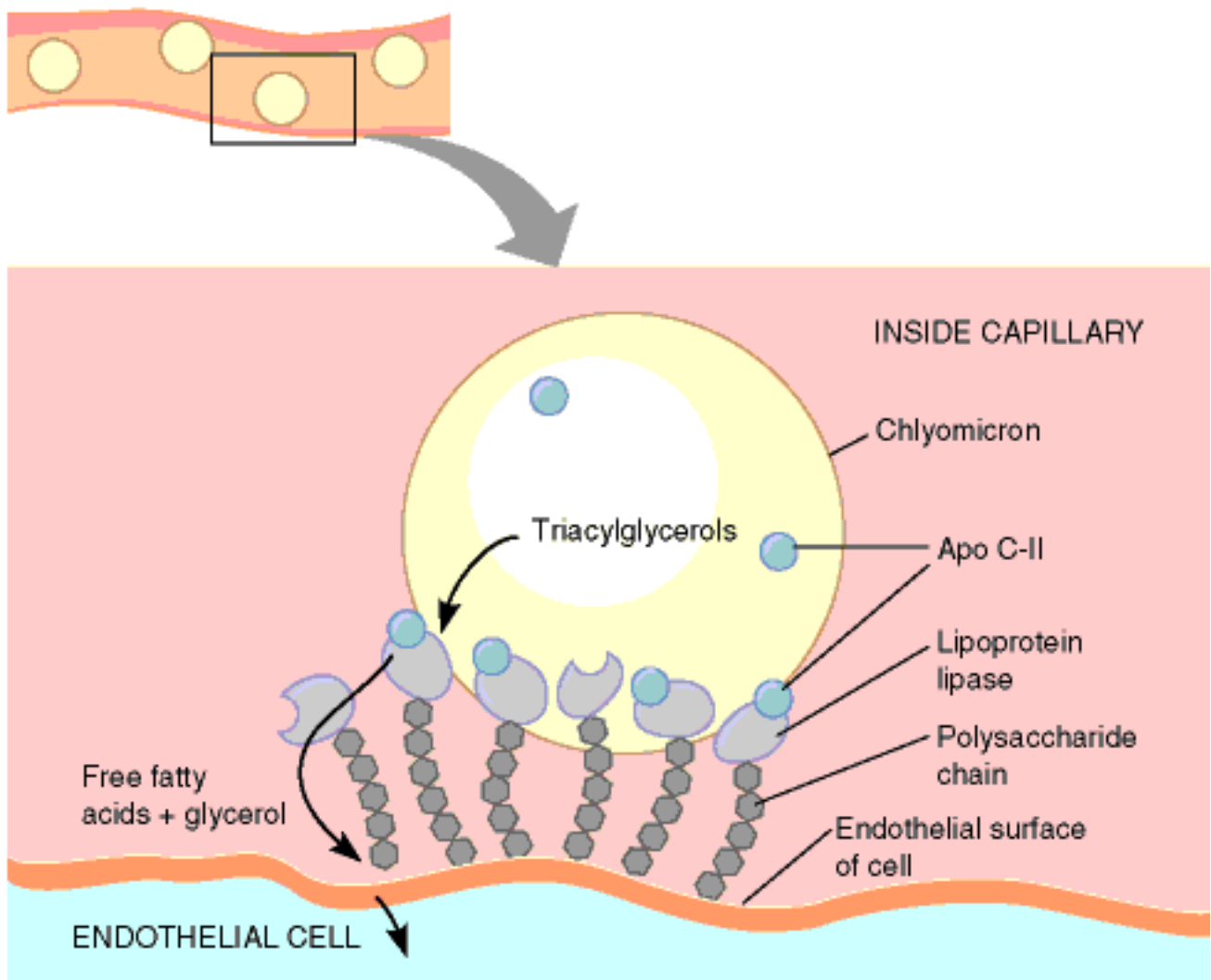

Apoprotein C-II (Apo C-II)

Apo C-II is a polypeptide of molecular weight 10,000 found primarily in VLDLs and, to a lesser extent, in chylomicrons ([Table 18.1](#)). **Apo C-II** activates Lipoprotein Lipase. A human deficiency of **Apo C-II** is associated with elevated triacylglycerol levels in blood. Apo E is also found in the **Apo C-II** gene cluster.

See also: [Table 18.2](#), [Lipoproteins](#), [Apoproteins](#), [VLDLs](#), [Chylomicrons](#), [Lipoprotein Lipase](#), [Apo E](#)

INTERNET LINK: [Lipid Transport](#)

Apoprotein E (Apo E)

Apo E is a protein found in VLDLs, LDLs, and HDLs ([Table 18.1](#)). With a molecular weight of 33,000, **Apo E** is involved in binding lipoprotein complexes to the LDL receptor. **Apo E** is found in the human Apo C-II gene cluster and a variant of **Apo E** has been associated with an increased risk for Alzheimer's disease.

See also: [Table 18.2](#), [Lipoproteins](#), [Apoproteins](#), [VLDLs](#), [LDLs](#), [HDLs](#), [LDL receptor](#), [Apo C-II](#)

INTERNET LINKS:

1. [Lipid Transport](#)
-

Apoprotein C-III (Apo C-III)

Apo C-III is a polypeptide of molecular weight 9,300 found primarily in chylomicrons, VLDLs, and HDLs ([Table 18.1](#)). **Apo C-III** inhibits the action of Lipoprotein Lipase.

See also: [Table 18.2](#), [Lipoproteins](#), [Apoproteins](#), [Chylomicrons](#), [VLDLs](#), [HDLs](#), [Lipoprotein Lipase](#)

INTERNET LINK: [Lipid Transport](#)

Apoprotein D (Apo D)

Apo D is a polypeptide found in HDLs ([Table 18.1](#)). **Apo D** is also called cholesterol ester transfer protein.

See also: [Table 18.2](#), [Lipoproteins](#), [Apoproteins](#), [HDLs](#)

INTERNET LINK: [Lipid Transport](#)

Diabetes



In starvation, **glucose** utilization is abnormally low because of inadequate glucose supplies. In **diabetes mellitus**, glucose utilization is similarly low, but it is low because the hormonal stimulus to glucose utilization--namely, **insulin**--is defective. As a result, glucose is present in excessive amounts in the blood, but in deficient amounts in the cells of peripheral tissues. The consequences of insulin deficiency are comparable to those of starvation in revealing important aspects of interorgan metabolic relationships.

Diabetes mellitus is not a single disease but rather a family of diseases.

Insulin-dependent **diabetes** often involves autoimmune destruction of the B cells of the pancreas, which can be caused by various factors, including viral infection.

Some forms of **diabetes** have a genetic origin. Mutations in insulin structure can render the hormone inactive, and other mutations cause defects in the conversion of preproinsulin or proinsulin to the active hormone. In these cases, treatment involves administration of insulin.

Some forms of the disease involve mutations in the structure of the cellular **insulin receptor** or in its intracellular activities that promote glucose utilization. These latter forms of the disease are called insulin-resistant **diabetes**, because patients cannot respond to therapeutic doses of insulin.

The failure of insulin to act normally in promoting glucose utilization by cells, with resultant glucose accumulation in the blood, starves the cells of nutrients and promotes metabolic responses similar to those of fasting (**Figure 23.5**). Liver cells attempt to generate more glucose by stimulating **gluconeogenesis**. Most of the substrates come from **amino acids**, which in turn come largely from degradation of muscle proteins. Glucose cannot be reused for resynthesis of amino acids or of fatty acids, so a diabetic may lose weight even while consuming what would normally be adequate calories in the diet.

As cells attempt to generate usable energy sources, **triacylglycerol** depots are mobilized in response to high glucagon levels. Fatty acid oxidation is elevated, with concomitant generation of **acetyl-CoA**. Activity of the **citric acid cycle** may decrease, due to accumulation of reduced electron carriers and/or **Oxaloacetate** limitation. In liver, both effects accelerate ketone body formation, generating increased levels of organic acids in the blood. These acids can lower the blood pH from the normal value of 7.4 to 6.8 or lower. Decarboxylation of **acetoacetate**, which is stimulated at low pH, generates **acetone**, which can be smelled on the breath of patients in severe uncontrolled diabetic situations.

Excessive concentrations of glucose in body fluids generates other metabolic problems. At blood glucose levels above 10 mM, the kidney can no longer reabsorb all of the glucose in the blood filtrate, and glucose is spilled into the urine, sometimes in amounts approaching 100 grams per day. Glucose excretion creates an osmotic load, which causes large amounts of water to be excreted as well. Under these conditions the kidney cannot reabsorb most of this water. As a result, the earliest indications of diabetes are often frequent and excessive urination, coupled with excessive thirst.

When diabetes strikes in childhood (the insulin-dependent form of the disease, representing about 10% of all cases), the metabolic imbalance is usually more severe and difficult to control than in the milder and more common adult-onset form. The latter can often be controlled by dietary restriction of carbohydrate, whereas treatment for juvenile diabetes usually involves daily self-injection of insulin.

See also: [Maintaining Blood Glucose Levels](#), [Response to Starvation](#), [Action of Insulin](#), [Action of Glucagon](#), [Peptide Hormone Synthesis](#)

INTERNET LINK: [Type I Insulin Dependent Diabetes Mellitus](#)

Figure 23.5: The metabolic abnormalities in diabetes.

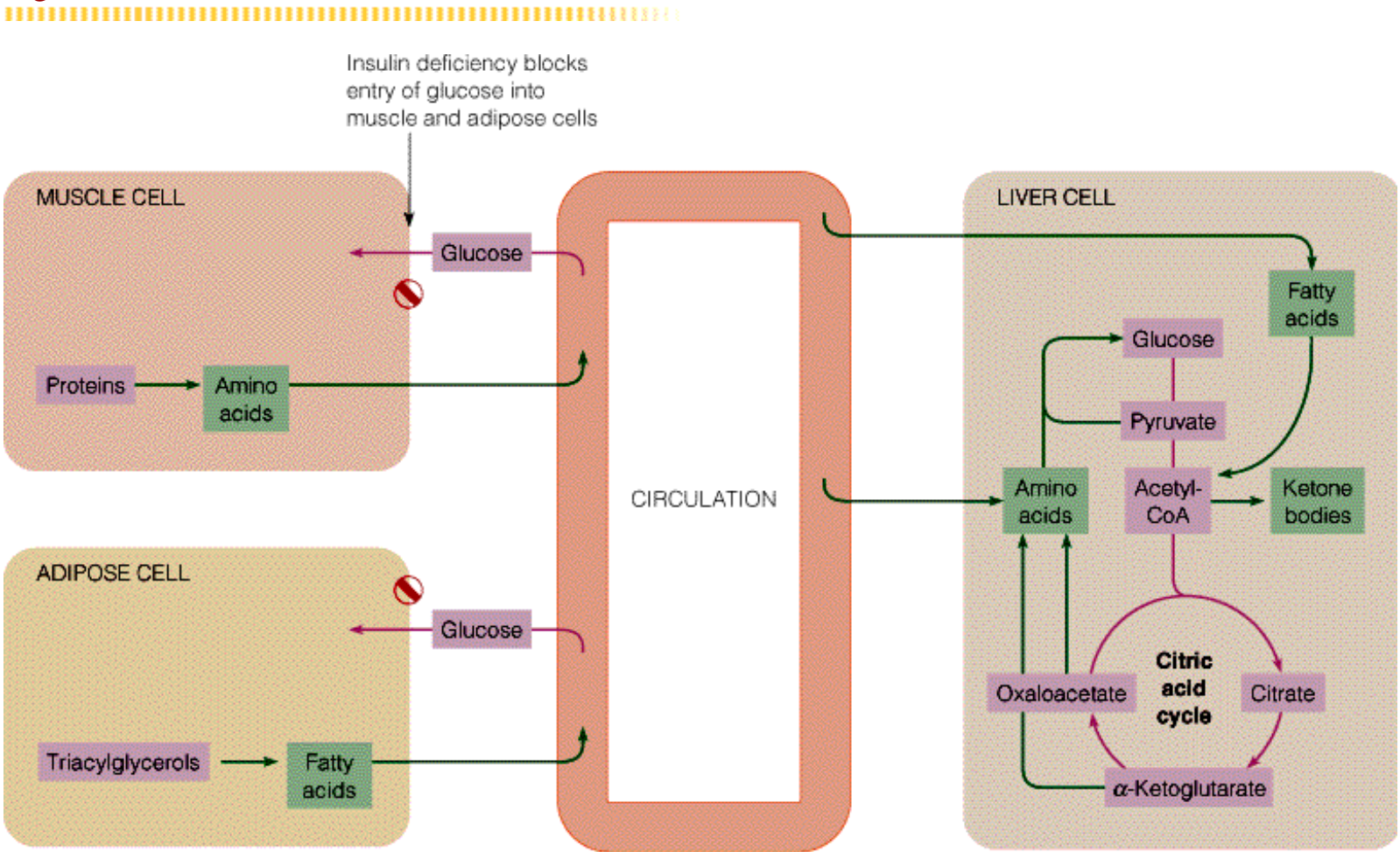

Acetone

Acetone is produced in the body as a product of ketone body metabolism.

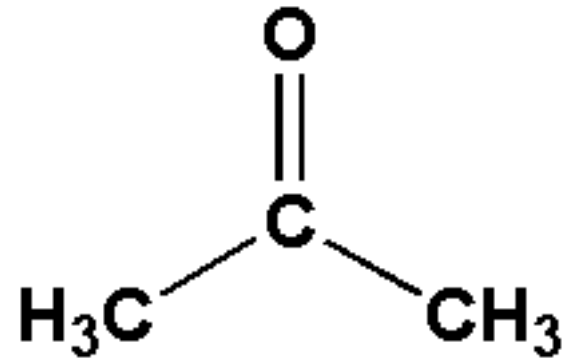

Acetone

The reaction making **acetone** can occur non-enzymatically or can be catalyzed by the enzyme acetoacetate decarboxylase. The presence of **acetone** on a person's breath is a sign they are undergoing ketogenesis - formation of ketone bodies. This can indicate starvation or metabolic anomalies associated with diabetes.

See also: [Ketone Bodies](#), [Ketogenesis](#)

Peptide Hormone Synthesis

Synthesis of [steroid hormones](#) (shown [here](#)) and of [catecholamines](#) (see [Figure 21.32](#)) and thyroid hormones ([Figure 21.19](#)), occur via straightforward metabolic pathways.

Nearly all **peptide hormones** are synthesized as inactive precursors and then converted to active hormones by proteolytic processing. Studies of the synthesis of [insulin](#) provided the first evidence of this phenomenon (see [Figure 5.21](#)). Insulin contains two polypeptide chains, of 21 and 30 residues, with two interchain disulfide bridges and one intrachain bridge ([Figure 5.15](#)).

The first product of translation of the insulin gene is a 105-residue polypeptide called preproinsulin. Cleavage from preproinsulin of a 24-residue N-terminal "signal sequence" yields proinsulin, an 81-residue polypeptide. Proinsulin then undergoes folding, disulfide bond formation, and cleavage to give the two polypeptide chains of the active hormone, insulin. The signal sequence that is eventually cleaved from preproinsulin to form proinsulin is needed transport the protein through membranes (see [here](#)).

All known polypeptide hormones are synthesized in "prepro" form, with a signal sequence and additional sequence(s) that are cleaved out during maturation of the hormone.

A particularly interesting case is that seen when a single polypeptide sequence contains two or more distinct hormones. The most complex example is a pituitary multihormone precursor that contains sequences for β - and γ -lipotropin, α -, β -, and γ -melanocyte-stimulating hormone (MSH), endorphin, enkephalin, and [ACTH](#) ([Figure 23.10](#)). This precursor, called pro-opiomelanocortin, derives its name from its role as precursor to endogenous opiates, melanocyte-stimulating hormone, and corticotropin. A remarkable fact about pro-opiomelanocortin is that it is cleaved at different sites in different cells, so that different cell types produce different ensembles of hormones derived from this one precursor.

Cleavage sites are shown in red in [Figure 23.10](#). In the anterior pituitary, cleavage generates ACTH and β -lipotropin, and further processing in the central nervous system yields endorphin and enkephalin, among other products.

See also: [Hormone Hierarchy of Action](#), [Hormone Action](#)

INTERNET LINKS:

1. [Enkephalins](#)

2. The Biology of Pleasure (endorphins and enkephalins)

Figure 5.21: Structure of preproinsulin and its conversion to insulin.

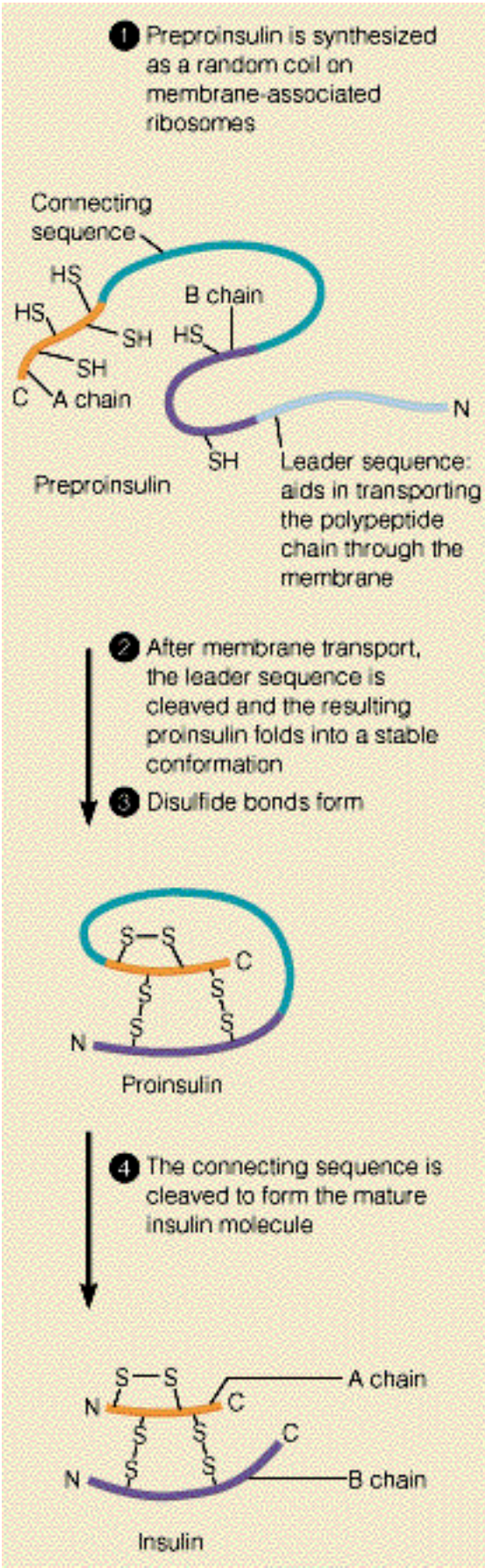

See also: **Post Translational Modification of Proteins**

Figure 5.15: The primary structure of bovine insulin.

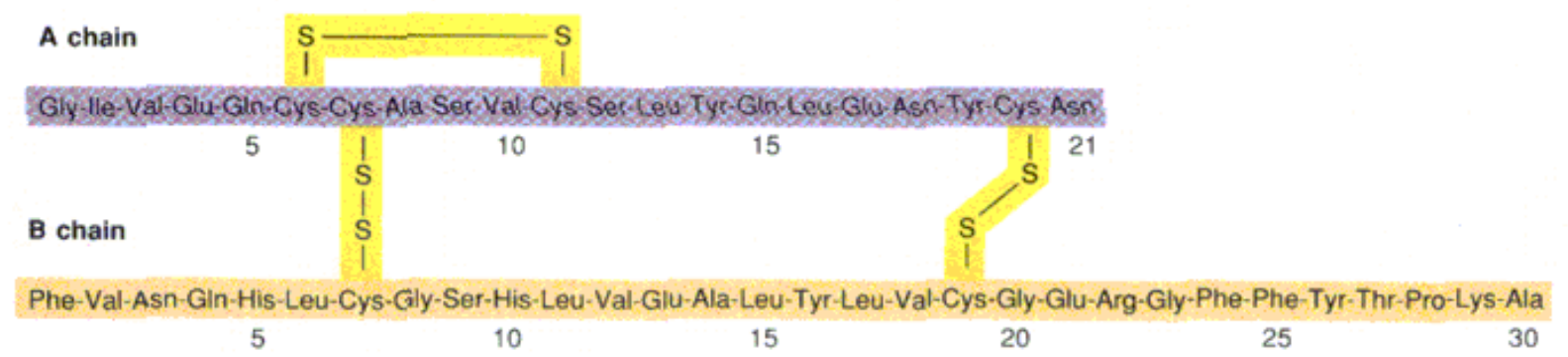

Covalent Modification of Proteins

In addition to folding, there are other **modifications** that happen to proteins after translation is completed. In prokaryotic organisms, for example, the N-formyl group is removed from most proteins by an enzyme called a deformylase. This can happen as soon as the N-terminus emerges from the ribosome.

Bacterial proteins destined for secretion (translocation across the cell membrane) contain highly hydrophobic stretches of amino acids (called signal sequences or leader sequences) at their amino terminal region. Examples are shown in Table 27.5. After the protein has passed through the membrane, the leader sequence is cleaved off at the point shown by the arrow in the table.

The currently accepted model for translocation is shown in Figure 27.30. Steps are as follows:

The protein to be translocated (called a pro-protein) is complexed in the cytoplasm with a chaperone (for example, the Sec B protein). The complex keeps the protein from folding prematurely, which would prevent it from passing through the secretory pore, which consists of two transmembrane proteins, Sec E and Sec Y. Sec A is an ATPase that helps drive the translocation. After the pro-protein is translocated, the leader peptide is cleaved by a membrane-bound protease and the protein can fold into its active three-dimensional form.

See also: Polypeptide Chain Folding, Covalent Modifications to Regulate Enzyme Activity (from Chapter 11)

Table 27.5

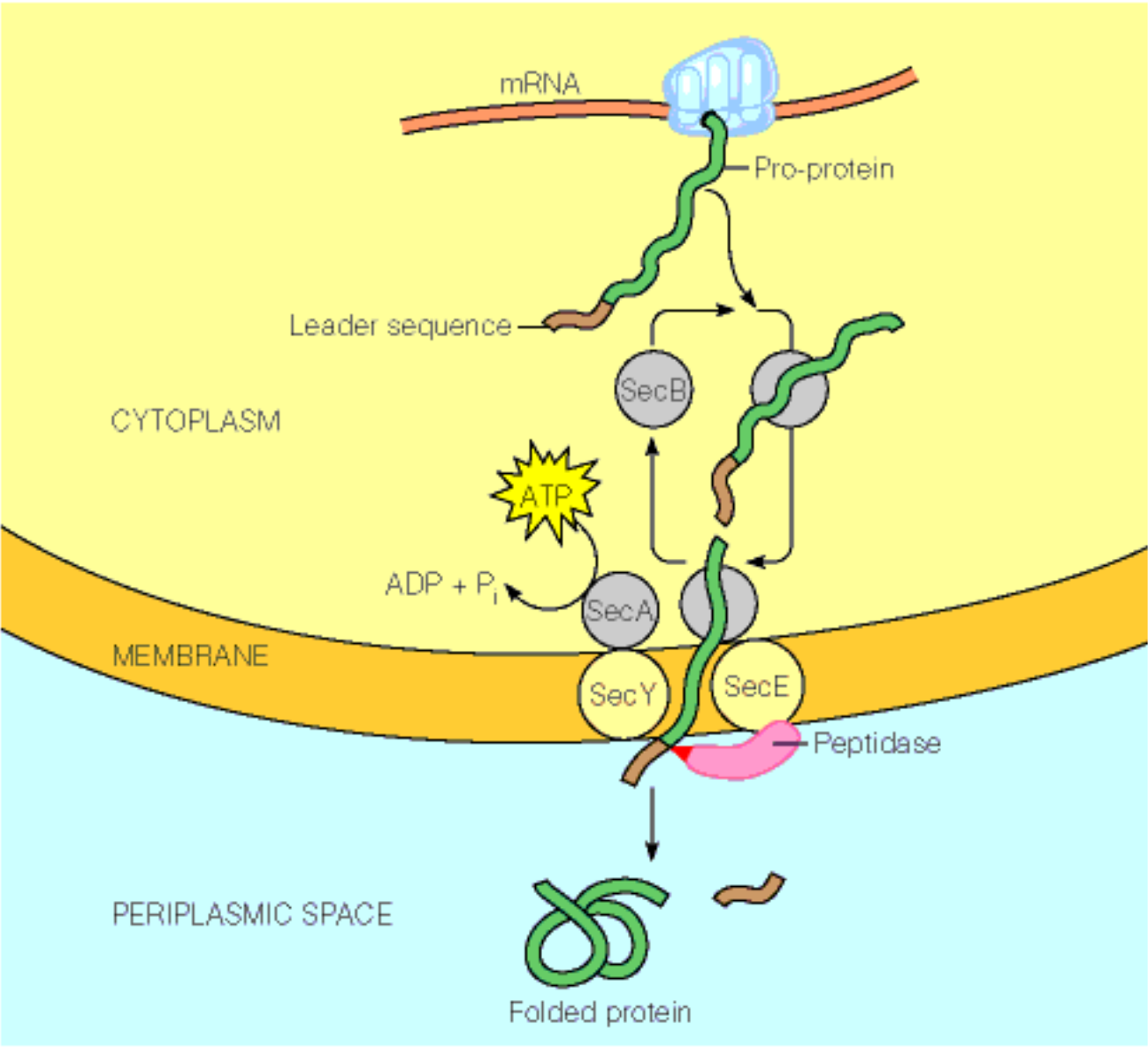

TABLE 27.5 N-terminal signal sequences of representative prokaryotic pr

Protein	-20	-15	-10	-5	-1 ↓	+1	
Leucine-binding protein	M K A N A K T I I A G M I A L A I S H T A M A					E E ...	
Prealkaline phosphatase	M K Q S T I A L A L L P L L F T P V T K A					R T ...	
Prelipoprotein	M K A T K L V L G A V I L G S T L L A G					C S ...	

Note: Hydrophobic residues are in red. The cleavage site is designated by the arrow.

Figure 27.30: A current model for protein secretion by prokaryotes.



Adrenal Corticotrophic Hormone (ACTH)

Adrenal Corticotrophic Hormone (ACTH) (also called β -**corticotropin**) is a peptide hormone secreted by the anterior pituitary gland. **ACTH** stimulates the adrenal cortex to produce **glucocorticoids** and **mineralocorticoids**, which in turn act on a number of tissues (**Figure 23.8**).

See also: [Hormone Hierarchy of Action](#), [Steroid Hormones](#), [Steroid Hormone Synthesis](#)

INTERNET LINK: [ACTH](#)

Hormone Hierarchy of Action

Hormonal regulation involves a hierarchy of cell types acting on each other either to stimulate or to modulate the release and action of a **hormone**. Secretion of **hormones** from endocrine cells is stimulated by chemical signals from regulatory cells that occupy a higher position in this hierarchy ([Figure 23.8](#)).

The **hierarchical nature of hormone action** can be summarized as follows:

1. **Hormonal** action is controlled ultimately by the central nervous system, which transmits signals to the hypothalamus. It responds by producing factors that either stimulate (called releasing factors) or inhibit the release of **hormones** from the pituitary.
2. Pituitary **hormones** do one of the following:
 - a. They stimulate other endocrine glands, each of which releases a **hormone** that acts on a target tissue and elicits a specific metabolic response.
 - b. Alternatively, they act directly on a target tissue. The action of a **hormone** sets in motion events that ultimately limit that action.

Some pituitary **hormones** stimulate target tissue directly. For example, prolactin stimulates mammary glands to produce milk.

Most pituitary **hormones** act on endocrine glands that occupy an intermediate, or secondary, position in the hierarchy, stimulating them to produce **hormones** that exert the ultimate actions on target tissues. Pituitary **hormones** that act on other endocrine glands are called tropic **hormones** or tropins. An example is adrenal corticotropic **hormone** ([ACTH](#)), also called β -corticotropin (see [here](#) also). This peptide is secreted from the anterior pituitary, and it stimulates the adrenal cortex to produce [glucocorticoids](#) and [mineralocorticoids](#), which in turn act on a number of tissues.

The action of a **hormone** is self-limiting because of the existence of feedback loops, in which secretion of a **hormone** sets in motion a series of events that leads to inhibition of that secretion ([Figure 23.9](#)).

See also: [Hormone Action](#), [Hormone Mechanisms of Action](#), [Hormone Receptors](#), [Steroid Hormone Synthesis](#) (from Chapter 19)

INTERNET LINK: [ACTH](#)

Corticotropin Releasing Hormone (CRH)

The neurohormone **corticotropin-releasing hormone (CRH)**, is released from cells in the hypothalamus in response to central nervous system inputs. **CRH** stimulates release from the pituitary gland of corticotropin, or adrenocorticotrophic hormone (**ACTH**), which in turn stimulates the synthesis of **mineralocorticoids** and **glucocorticoids** in adrenal cortex.

See also: [Figure 23.8, Hormone Hierarchy of Action](#), [Peptide Hormone Synthesis](#)

Figure 23.10: Structure and properties of pro-opiomelanocortin.

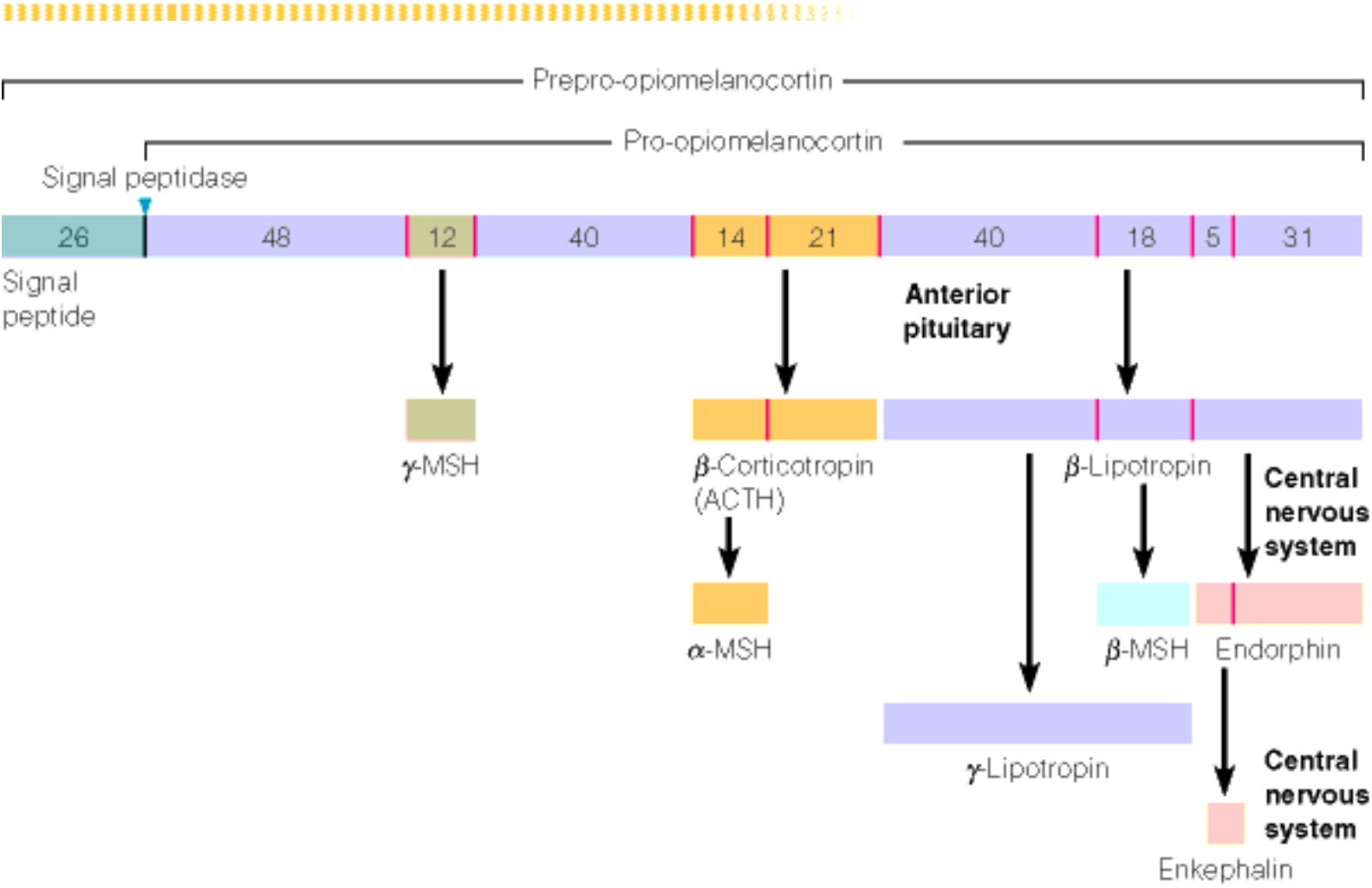
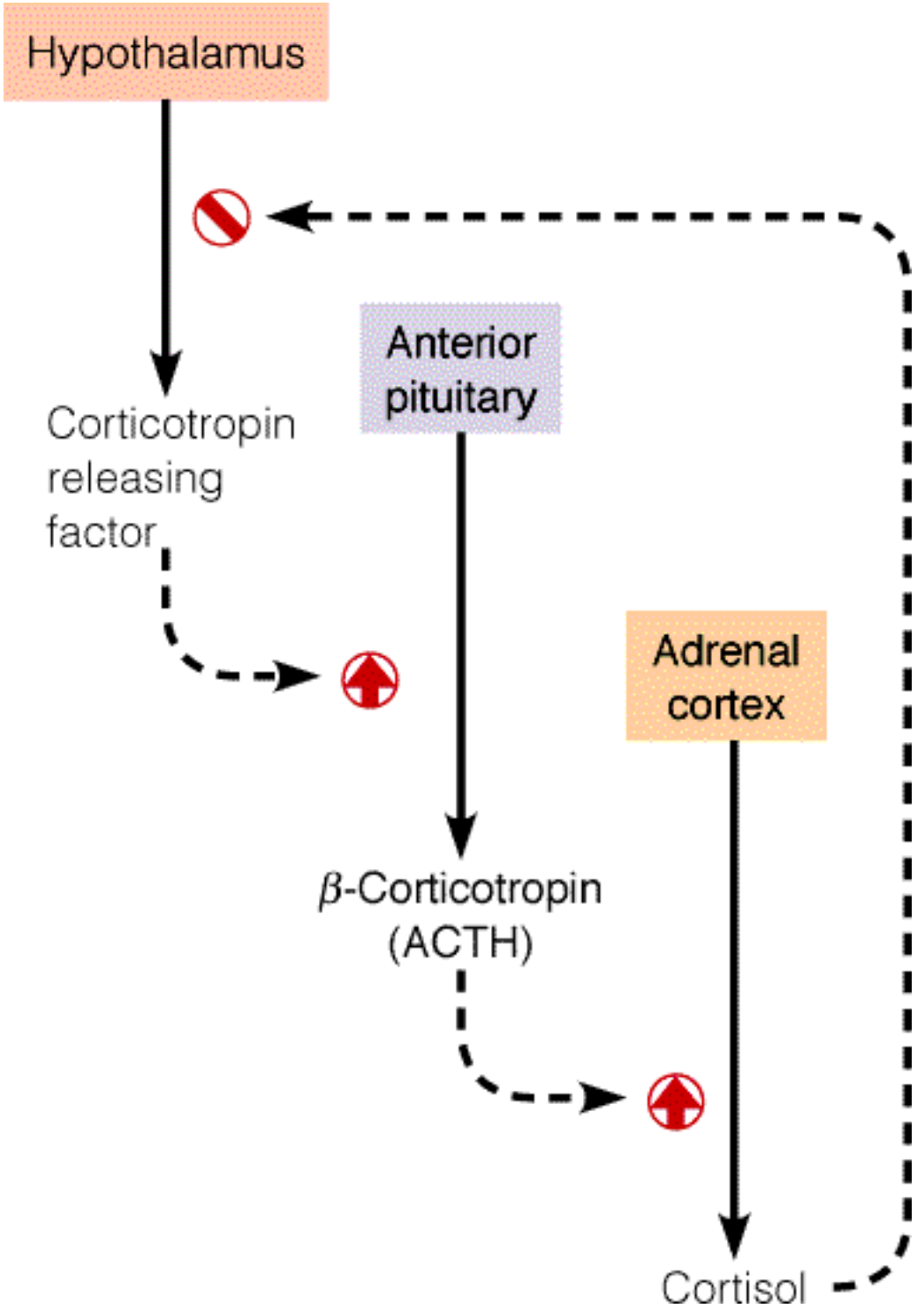

Figure 23.9: An example of feedback regulation of a hormone.



Concepts



Molecular Structures and Properties of Lipids

Lipids in Biological Membranes

Membrane Proteins

Membrane Fluidity

Membrane Asymmetry

Erythrocyte Membrane

Thermodynamics of Transport Across Membranes

Passive Versus Active Transport

Transport Mechanisms

Passive Transport Mechanisms

Active Transport Mechanisms

Resting Potential

Neurotransmission

Unnumbered Item

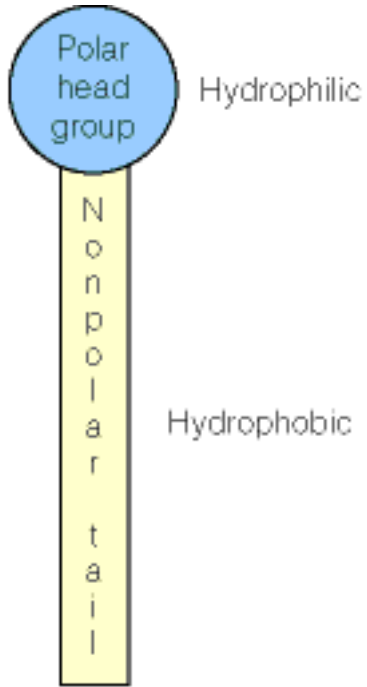

General lipid structure

Figure 10.1: Structures of the ionized forms of some representative fatty acids.

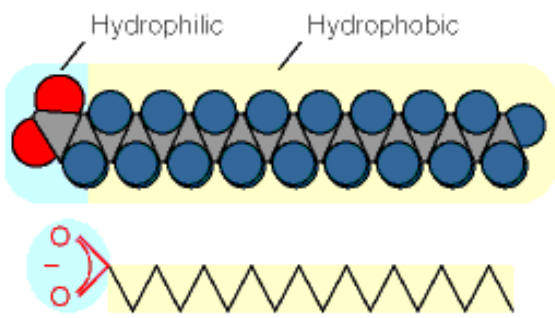

(a) Stearate ion

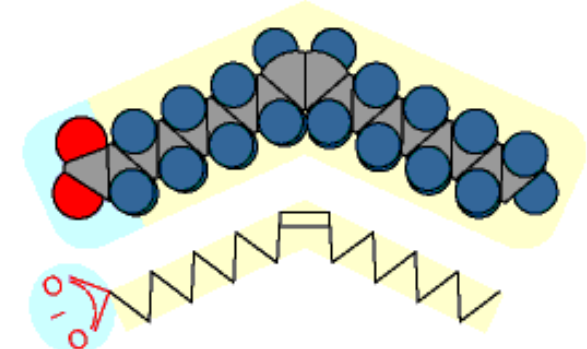

(b) Oleate ion

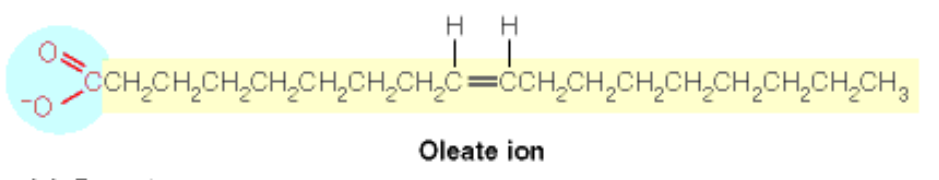
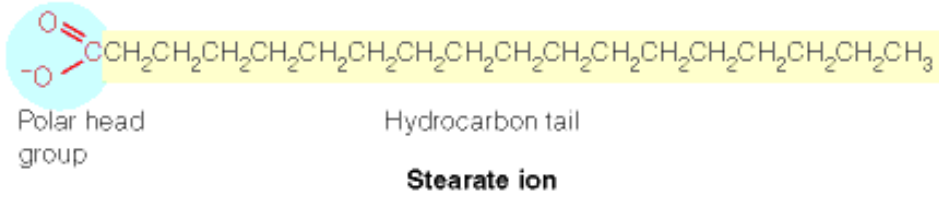

(c) Formulas

Figure 10.5: Phospholipids and membrane structure.

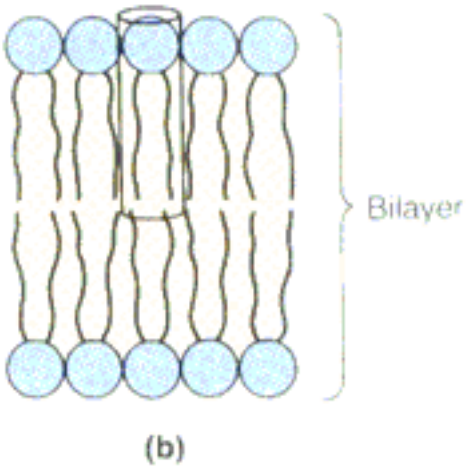
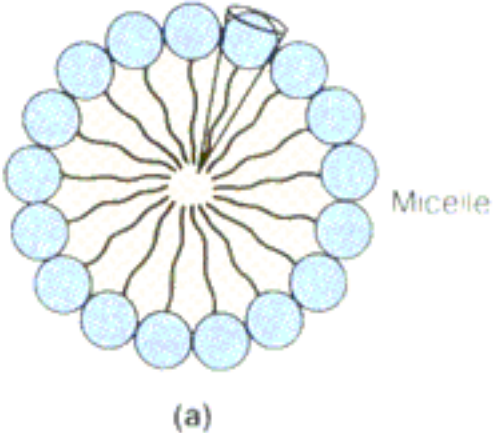

Membrane Fluidity

Biological membranes are **fluid** in nature. For example, when individual cells with different surface protein markers are fused, the initially separated proteins rapidly mix on the newly formed hybrid ([Figure 10.11](#)). This phenomenon is known as lateral diffusion, because molecules move laterally within the plane of the **membrane**. By contrast, in the much less frequent transverse diffusion, a molecule moves from one side of the **lipid bilayer** to the other.

The **fluidity** of a **membrane** is a function of its lipid composition and temperature. For example, lower temperatures tend to decrease **membrane fluidity** because the molecules of the lipid bilayer tend to form regular, more rigid crystalline structures. Higher temperatures favor less regular, more gel-like structures. The temperature at which a **membrane** converts from crystalline to gel-like structures is referred to as the transition temperature ([Figure 10.12](#)).

The transition temperature itself depends on the composition of the lipids in the **membrane**. **Membrane** lipids with shorter fatty acids or unsaturated fatty acids have lower transition temperatures. In addition, the composition of the polar head group can have a drastic effect. For example, an ethanolamine head group raises the transition temperature compared to a choline head group. Organisms have **membrane** compositions consistent with transition temperatures somewhat below their lowest body temperature.

[Cholesterol](#) has an interesting effect on **membrane fluidity**. As seen in [Figure 10.12b](#), cholesterol does not change the transition temperature of a membrane, but rather broadens the range of the transition considerably. It has been hypothesized that this broadening occurs because cholesterol can both stiffen the **membrane** above the transition temperature and inhibit regularity in structure formation below the transition temperature. Thus, it blurs the distinction between the gel and fluid state.

See also: [Glycerophospholipids](#), [Membrane Asymmetry](#)

INTERNET LINKS:

1. [Lipid Bilayer Simulation](#)
 2. [Lipid Bilayer Models for RasMol](#)
-

Figure 10.11: Experimental demonstration of membrane fluidity.

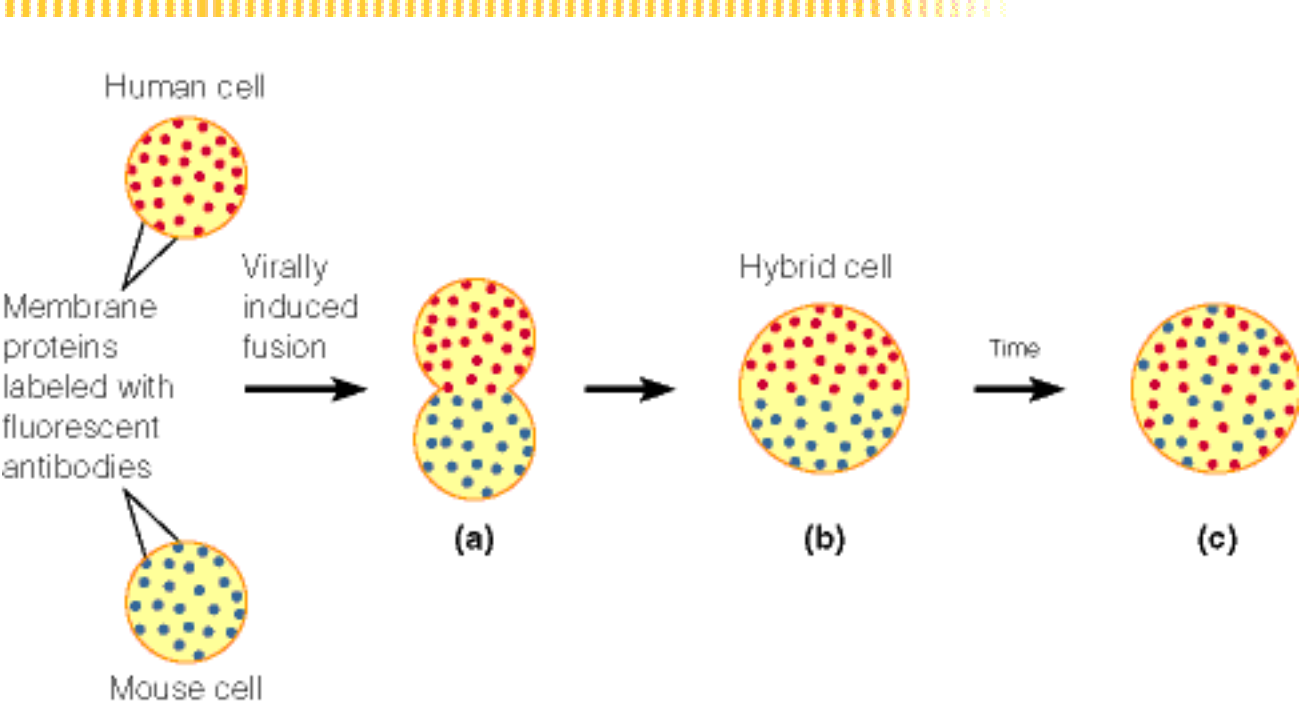

From W. M. Becker, L.J. Kleinsmith, and J. Hardin, *The World of the Cell*, 4th ed. (San Francisco, CA: Addison Wesley Longman, 2000) © Addison Wesley Longman, Inc.

Figure 10.12: The gel-liquid crystalline transition in a synthetic lipid bilayer.

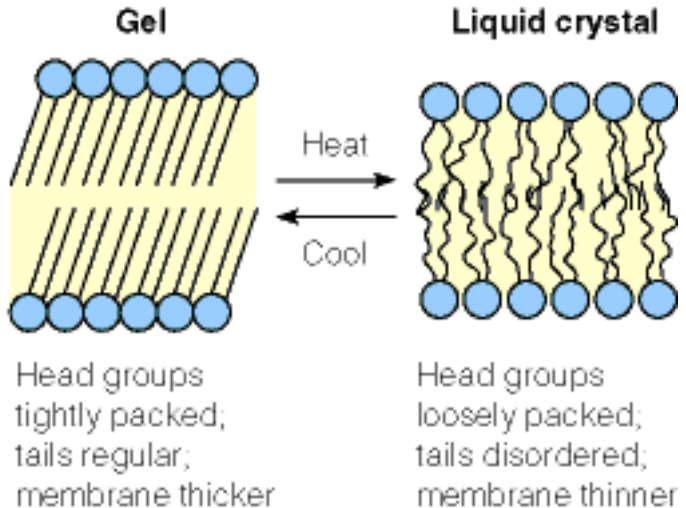

(a) Transition

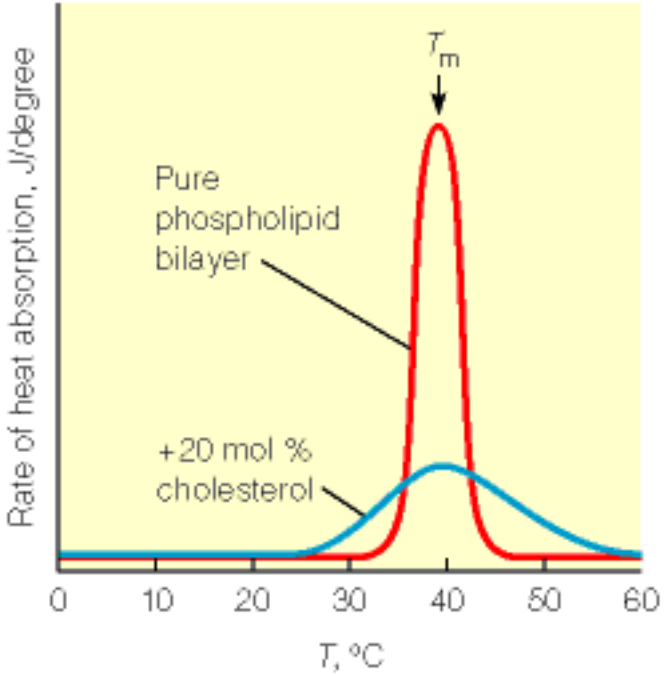

(b) Transition with and without cholesterol

Lipids in Biological Membranes

Biological membranes contain an interesting array of molecules. These include [glycerophospholipids](#), [sphingolipids](#), [cholesterol](#), proteins, carbohydrates, and some molecules which are conjugates containing molecules from two or more of these groups ([Figure 10.10](#)).

The primary structural requirement for a molecule to reside in a **lipid bilayer** is an amphiphilic nature (i. e., part polar, part nonpolar). Molecules are oriented within the **lipid bilayer** so that their nonpolar portion is inserted into (and sometimes through) the nonpolar core of the **bilayer**. The polar portion associates with the polar outsides of the **bilayer**.

Membrane proteins have their polypeptide chains folded so that the nonpolar regions associate with each other in a cluster. This nonpolar unit then sticks into the nonpolar part of the **bilayer** with the remaining polar parts sticking out. Some protein molecules, such as bacteriorhodopsin, actually extend though both sides of the **lipid bilayer**.

The presence of bulky nonpolar molecules, such as cholesterol, disrupts the regularity of a **lipid bilayer**.

See also: [Membrane Proteins](#)

INTERNET LINKS:

1. [Lipid Bilayer Simulation](#)
 2. [Lipid Bilayer Models for RasMol](#)
-

Oxidation as a Metabolic Energy Source

Thermodynamically, biological **oxidation** of organic substrates is comparable to nonbiological **oxidations**, such as the burning of wood. The total free energy released is the same, whether the source is a biological substance, such as **glucose**, or the oxidation of a compound in a wood fire, calorimeter, or cell.

Biological **oxidations**, however, are far more complex processes than combustion. When wood is burned, all of the energy is released as heat; that is, useful work cannot be performed, except through the action of a device such as a steam engine. In biological **oxidations**, by contrast, **oxidation** reactions occur without a large increase in temperature and with capture of some of the free energy as chemical energy.

Metabolic energy capture occurs largely through the synthesis of ATP, a molecule designed to provide energy for biological work. The capture of energy is quite efficient. In the catabolism of glucose, for example, about 40% of the 2870 kJ/mol of energy released is used to drive the synthesis of ATP from **ADP** and Pi.

Unlike the **oxidation** of glucose by oxygen (as in a fire), most biological **oxidations** do not involve direct transfer of electrons from a substrate directly to oxygen. Instead, a series of coupled **oxidation-reduction** reactions occurs, with the electrons passed to intermediate electron carriers such as NAD⁺ before they are finally transferred to oxygen.

Because the potential energy stored in the organic substrate is released in small increments, it is easier to control **oxidation** and capture some of the energy as it is released—small energy transfers waste less energy than a single large transfer.

Not all metabolic energy comes from **oxidation** by oxygen. Substances other than oxygen can serve as terminal electron acceptors. For example, some microorganisms growing anaerobically (in the absence of oxygen) generate energy by transferring electrons to inorganic substances, such as sulfate ion or nitrate ion. Other microorganisms, like the lactic acid bacteria, reduce organic substances, such as pyruvate, to form lactate. Most of these organisms derive their energy from fermentations, which are energy-yielding catabolic pathways that proceed with no net change in the **oxidation** state of the products as compared with that of the substrates.

Because metabolic energy comes primarily from **oxidative** reactions, the more highly reduced a substrate, the higher its potential for generating biological energy. Thus, combustion of fat provides more heat energy than combustion of an equivalent mass of carbohydrate.

Reducing equivalents can be defined as 1 mole of hydrogen atoms (one proton and one electron per H atom). For example, two reducing equivalents are used in the reduction of one half mole of oxygen to

water

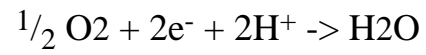

Remember that the breakdown of complex organic compounds yields both energy and reducing equivalents, but the biosynthesis of such compounds utilizes both.

See also: [ATP as Free Energy Currency](#), [Oxidative Phosphorylation](#) (from Chapter 18)

Factors Contributing to Large Energies of Hydrolysis of Phosphate Compounds

1. Resonance stabilization of phosphate products. [Figure 3.9](#) depicts the resonance stabilization of the orthophosphate ion, HPO_4^{2-} (abbreviated Pi). The multiple resonance forms are of equal energy, but all are not possible when the phosphate group is bound in an ester, such as ATP. Once Pi is released upon hydrolysis, however, the multiple resonance forms increase the overall entropy of the system, an energetically favorable process.
2. Additional hydration of hydrolysis products - Release of Pi allows greater opportunities for hydration. Hydration is an energetically favored state.
3. Electrostatic repulsion between charged products - When both products of hydrolysis are negatively charged (e.g., ADP and Pi in the hydrolysis of ATP), repulsion of the ionized products favors hydrolysis.
4. Enhanced resonance stabilization or tautomerization of product molecules - Hydrolysis is favored when product molecules can adopt multiple molecular forms. For example, pyruvate has two molecular forms, whereas PEP has only one.
5. Release of a proton in buffered solution - A proton is released in some hydrolysis reactions (see [Figure 3.7](#)), so hydrogen ion concentration (pH) influences the reaction.

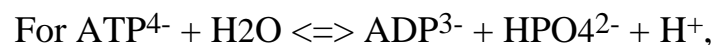

$\Delta G = \Delta G^\circ + RT \ln \left\{ \frac{([\text{ADP}^{3-}][\text{HPO}_4^{2-}][\text{H}^+])}{([\text{ATP}^{4-}][\text{H}_2\text{O}])} \right\}$, which can be rearranged as

$$\Delta G = \Delta G^\circ + RT \ln \left\{ \frac{([\text{ADP}^{3-}][\text{HPO}_4^{2-}])}{([\text{ATP}^{4-}])} \right\} + RT \ln \left\{ \frac{[\text{H}^+]}{[\text{H}_2\text{O}]} \right\}$$

Because $RT \ln \left\{ \frac{[\text{H}^+]}{[\text{H}_2\text{O}]} \right\}$ is relatively constant at pH 7.0 in biological systems, it can be incorporated into ΔG° to make $\Delta G^{\circ'}$. Thus,

$$\Delta G^{\circ'} = \Delta G^\circ + RT \ln \left\{ \frac{[\text{H}^+]}{[\text{H}_2\text{O}]} \right\}$$

See also: [Free Energy and Concentration](#), [ATP as Free Energy Currency](#) (from Chapter 12)

Figure 3.9: Resonance stabilization of orthophosphate, HPO_4^{2-} (Pi).

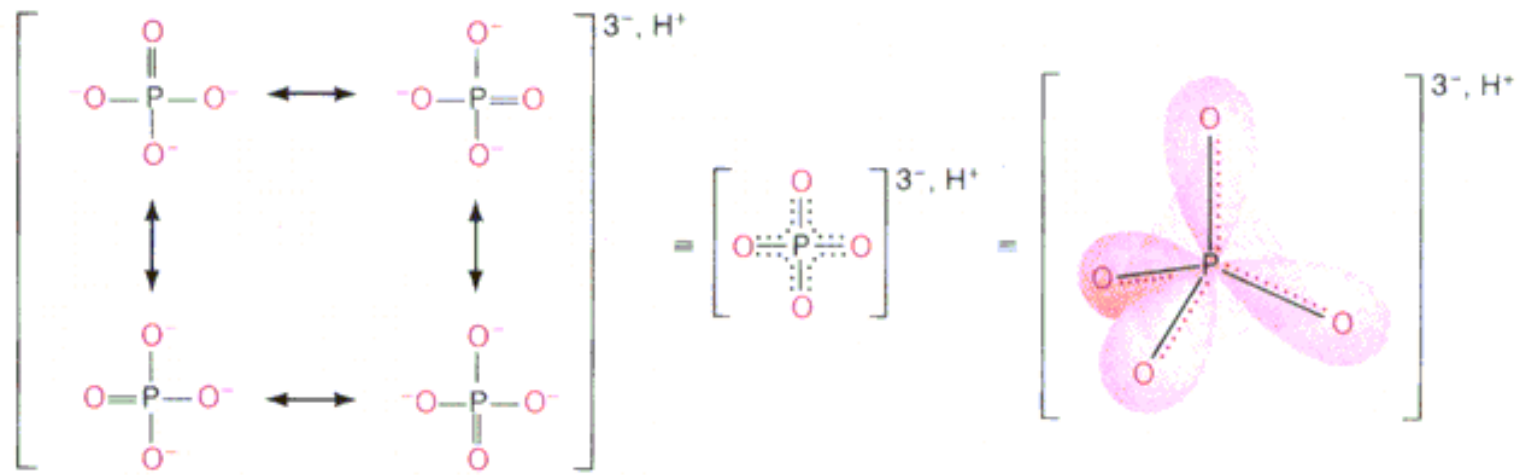

(a) Structures of phosphate ion contributing to resonance stabilization

(b) Resonance hybrid

(c) Molecular orbitals of tetrahedral phosphate ion

Free Energy Change and the Equilibrium Constant

Free energy is a state function, so ΔG for a reaction depends only on the **free energy** of the initial state (the reactants) and the **free energy** of the final state (the products):

$$\Delta G = G(\text{products}) - G(\text{reactants})$$

Consider the reaction $aA + bB \rightleftharpoons cC + dD$, where a is the number of moles of component A, b is the number of moles of component B, etc.

Using the equation for the chemical potential, and collecting the standard state terms into a single ΔG° , yields

$$\Delta G = \Delta G^\circ + RT \ln \left\{ \frac{[C]^c [D]^d}{[A]^a [B]^b} \right\}$$

Simplifying (and remembering that each product and reactant must be raised to the appropriate power) yields the following general equation for determining ΔG under any set of conditions, where ΔG° is the **free energy change** for the standard state (1M):

$$\Delta G = \Delta G^\circ + RT \ln \left\{ \frac{[\text{Products}]}{[\text{Reactants}]} \right\}$$

At equilibrium, the **equilibrium constant K** for the reaction is given by

$$K = \left\{ \frac{[C]^c [D]^d}{[A]^a [B]^b} \right\}$$

Recall that $\Delta G = 0$ at **equilibrium**, so substituting yields

$$0 = \Delta G^\circ + RT \ln K,$$

$$-\Delta G^\circ = RT \ln K, \text{ or}$$

$$K = e^{(-\Delta G^\circ / RT)}$$

Whenever a system is displaced from **equilibrium**, it will spontaneously proceed in the direction necessary to reestablish the **equilibrium** state. Negative ΔG is the driving force for such a reaction.

See also: [Internal Energy \(E\)](#), [Enthalpy](#), [Interplay of Enthalpy and Entropy](#)

Passive Versus Active Transport

The driving force for **passive transport** is simply the process of diffusion. Though this may be masked a bit by movement of molecules through pores or via carrier molecules, the end result of passive transport is always an equal concentration of the transported molecule on both sides of the membrane.

Equation 10.4 defines the net rate of **transport**, J in terms of membrane thickness (l), the diffusion coefficient (D_1), the partition coefficient (K), and the concentration difference ($C_2 - C_1$) of the compound across the membrane. This is simplified to $J = -P(C_2 - C_1)$, where P is the permeability coefficient (**Table 10.6**).

The slow process of diffusion is insufficient to **transport** many needed molecules across cellular membranes, so cells have evolved a variety of mechanisms for speeding up diffusion. This process, called **facilitated transport**, includes **pore-facilitated transport** and **carrier-facilitated transport**. It is important to note, however, that though pores or carriers speed the diffusion process, the driving force for each process is still diffusion, with all of its built-in limitations.

Active transport, on the other hand, couples transport of compounds across the membrane to energetically favorable processes, such as hydrolysis of **ATP**. Because of the additional energy provided by the coupled process, **active transport systems** can "pump" molecules against a concentration gradient. Thus, with **active transport** provided by the sodium-potassium pump, cells can maintain a higher concentration of potassium ions inside of the cell than outside and a higher concentration of sodium ions outside than inside.

In the sodium-glucose **cotransport** system (**Figure 10.27**), energy for the **transport** is provided by the high sodium ion concentration outside the cell compared to inside. This might seem to be a **passive transport** process, because diffusion of sodium ions into the cell carries glucose with it. It is not, however, because the sodium ions are pumped back out as they enter the cell, so the sodium ion concentration never comes to equilibrium inside and outside the cell. The sodium-glucose cotransport system is thus an **active transport system** that derives its energy from another **active transport system**—the sodium ion gradient maintained by the sodium-potassium pump (**Figure 10.26**).

See also: [Thermodynamics of Transport Across Membranes](#), [Passive Transport Mechanisms](#), [Active Transport Mechanisms](#)

Equation 10.4

$$J = -\frac{KD_1(C_2 - C_1)}{l} \quad (10.4)$$

11-*cis*-Retinal

11-*cis*-retinal is a derivative of **vitamin A** involved in vision.

See also: [G Proteins in Vision](#), [Chemistry of Photoreception](#)

INTERNET LINKS: [Rod Photoreceptor](#)

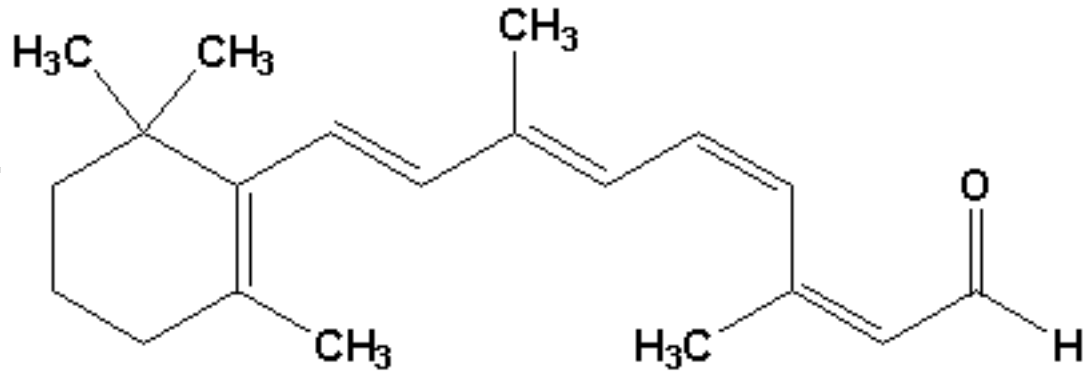

11-*cis*-Retinal

Bacteriorhodopsin

Bacteriorhodopsin is an integral bacterial membrane protein. As seen in [Figure 10.15](#), the linear polypeptide chain of **bacteriorhodopsin** folds back and forth several times in the membrane to provide a channel through which protons move. [Figure 10.16](#) shows that a plot of the hydrophobic tendency of amino acids in the protein parallels the regions embedded in the membrane. Thus, hydrophobic regions of the protein are embedded in the protein and hydrophilic regions are at the surfaces.

See also: [Membrane Proteins](#)

Figure 10.16: Hydrophobicity plot for the bacteriorhodopsin molecule depicted in Figure 10.15.

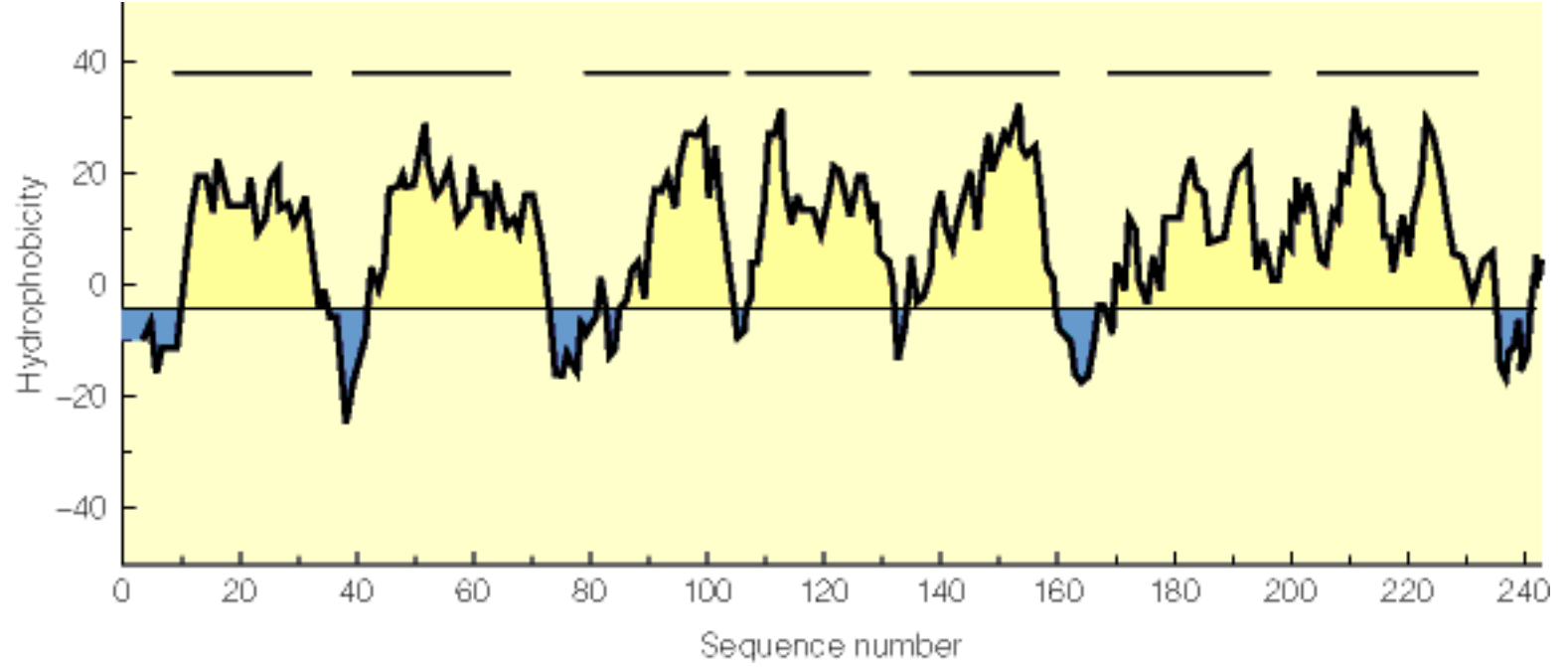

Adapted from J. Kyte and R. F. Doolittle, *J. Mol. Biol.* (1982) 157:105-132.

(See [Figure 10.15](#))

Figure 10.20: The two major mechanisms for facilitated transport.

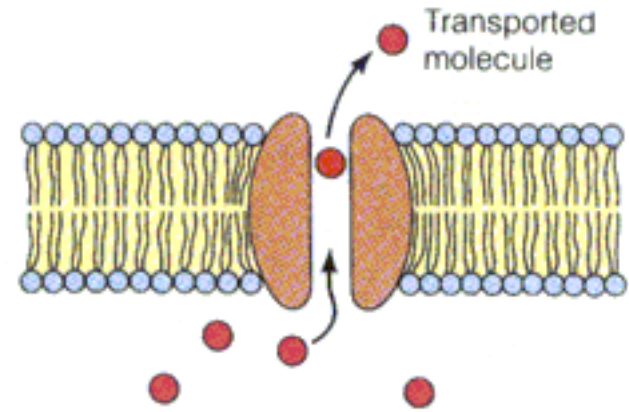

(a) Protein pores

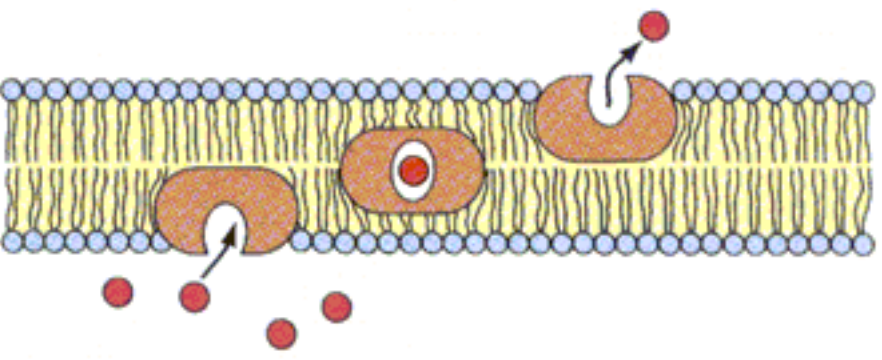

(b) Carrier molecules

Figure 10.22: Gramicidin A, an antibiotic that acts as an ion pore.

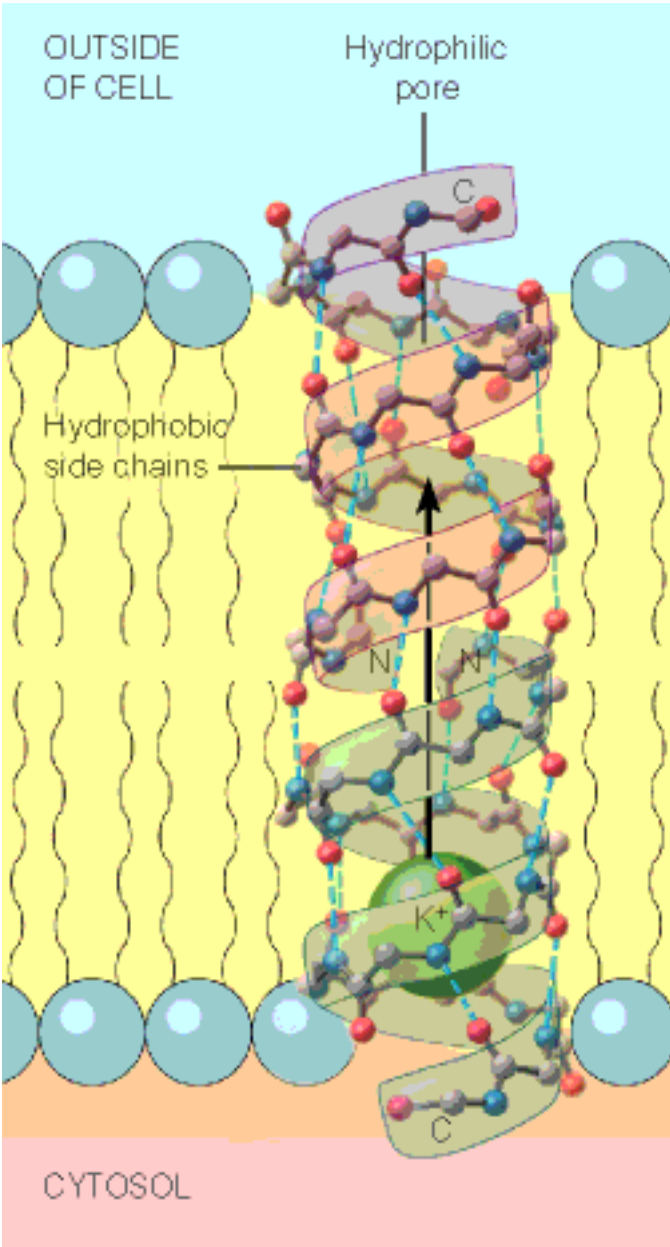

Valinomycin

Valinomycin is an antibiotic produced by the bacterium *Streptomyces* ([Figure 10.23](#)). **Valinomycin** is a cyclic polypeptide-like molecule, involving three repeats of the sequence (D-valine)–(L-lactate)–(L-valine)–(D-hydroxyisovalerate). Its folded conformation presents an outside surface rich in CH₃ groups and an interior cluster of nitrogens and oxygens that is well-suited to chelating cations.

The dimensions of the interior cavity nicely accommodate a K⁺ ion but do not fit other cations as well. This structure is exactly what is needed for a cation carrier: The outer surface is hydrophobic, making the molecule soluble in the lipid bilayer, whereas the inside mimics in some ways the hydration shell that the cation would have in aqueous solution. A molecule like **valinomycin** can diffuse to one surface of a membrane, pick up an ion, and then diffuse to the other surface and release it. There is no directed flow, but the carrier, in effect, increases the solubility of the ion in the membrane.

See also: [Passive Transport Mechanisms](#), [Sodium-Potassium Pump](#), [Lipid Bilayer](#)

Figure 10.23: Valinomycin, an antibiotic that acts as an ion carrier.

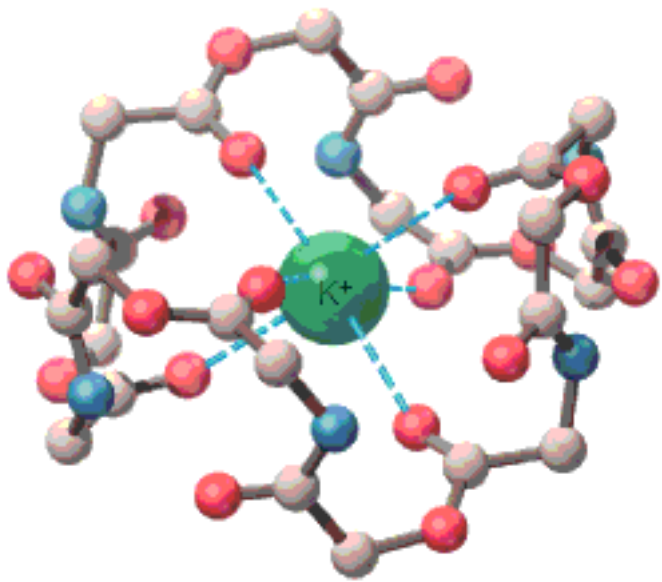
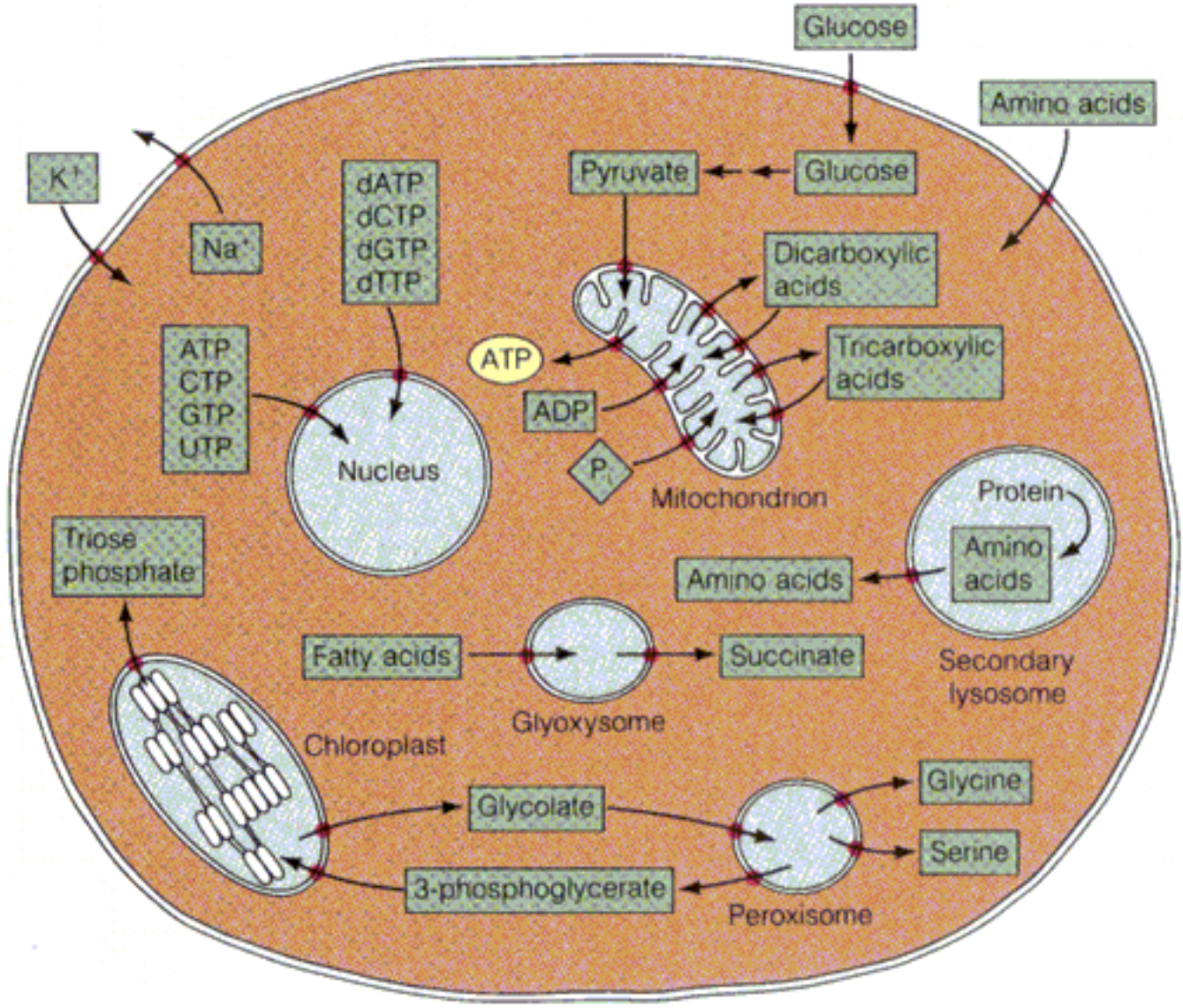

Figure 10.28: Specific transport processes.



3306610038

Choline Kinase

Choline kinase catalyzes the reaction that follows:



The reaction is part of the major biosynthetic pathway of [phosphatidylcholine](#) in animals ([Figure 19.5](#)).

See also: [Glycerophospholipids](#), [Glycerophospholipid Pathway](#), [Glycerophospholipid Metabolism in Eukaryotes](#)

INTERNET LINKS

1. [Glycerolipid Metabolism](#)
 2. [Phospholipid Catabolism](#)
-

CDP-Choline: 1,2-Diacylglycerol Phosphocholine Transferase

CDP-Choline: 1,2-diacylglycerol phosphocholine transferase catalyzes the following reaction in the biosynthetic pathway leading to phosphatidylcholine ([Figure 19.5](#))



See also: [Glycerophospholipids](#), [Glycerophospholipid Pathway](#), [Glycerophospholipid Metabolism in Eukaryotes](#)

INTERNET LINKS

1. [Glycerolipid Metabolism](#)
 2. [Phospholipid Catabolism](#)
-

Cholesterol Esters

Cholesterol esters are synthesized in plasma from cholesterol and an acyl chain on phosphatidylcholine via a reaction catalyzed by lecithin:cholesterol acyltransferase (LCAT). Another mechanism for making cholesterol esters is via the enzymatic reaction catalyzed by ACAT.

Cholesterol esters are considerably more hydrophobic than cholesterol itself. The amounts of cholesterol and **cholesterol esters** associated in blood lipoprotein complexes called LDL are typically about two-thirds of the total plasma cholesterol (total plasma cholesterol ranges from 130 to 260 mg/100 mL of human plasma, with the most desirable levels between 160 and 200). More than 40% of the weight of the LDL particle is **cholesterol esters**, and the total of esterified and free cholesterol amounts to well over half the total weight.

See also: [Figure 18.7](#), [Cholesterol](#), [Phosphatidylcholine](#), [LCAT](#), [Lipoprotein Complexes](#), [LDL](#), [ACAT](#)

Acyl-CoA: Cholesterol Acyltransferase (ACAT)

ACAT is an intracellular enzyme that catalyzes synthesis of cholesterol esters from cholesterol and long chain fatty acyl-CoA:



ACAT is activated by cholesterol internalized by a cell during receptor-mediated endocytosis. The esterified form of cholesterol is for storage.

See also: [Receptor Mediated Endocytosis](#), [Lipoprotein Complexes in Fat Transport](#)

Lipoprotein Complexes in Fat Transport

Five major classes of lipoprotein complexes transport the hydrophobic fats through the aqueous environment of the bloodstream ([Table 18.1](#) and [Figure 18.7](#)). Free lipids are all but undetectable in the blood. The protein components of the lipoprotein complexes ([Table 18.2](#)) are called apo(lipo)proteins. A summary of the functions of the various lipoprotein complexes is as follows:

Chylomicrons - **Chylomicrons** emulsify dietary lipids and carry them from the lymph system through the blood stream to tissues. **Chylomicrons** carry dietary cholesterol and have the lowest density of the lipoprotein complexes. Digestion of fats (in capillaries) from **chylomicrons** produces **chylomicron remnants**, which are taken up by the liver.

Very Low-Density Lipoprotein (VLDL) - **VLDLs** transport triacylglycerols (and other lipids to a lesser extent) that are synthesized in the liver to target tissues via the bloodstream. Fats in **VLDLs** are largely hydrolyzed in capillaries of peripheral tissues by **lipoprotein lipase**.

Intermediate-Density Lipoprotein (IDL) - **IDLs** are remnants of the VLDLs remaining after the fats have been digested in the capillaries are called **IDLs** ([Figure 18.7](#)). **IDLs**, like the chylomicron remnants, are taken up by the liver via a specific receptor.

Low-Density Lipoprotein (LDL) - **LDLs** are produced by the liver and are the principal form in which cholesterol is transported to tissues ([Figures 18.7, 18.10](#)). More than 50% of the weight of the **LDL** particle is composed of cholesterol esters and free cholesterol. **LDLs** are absorbed by target cells in a process called receptor-mediated endocytosis. This occurs when the **LDL** interacts with a specific **LDL receptor**. Components of **LDLs**, such as unsaturated fatty acids, cholesterol, and amino acid residues of the apoprotein, are readily oxidized (forming oxidized **LDLs**). Oxidized **LDLs** are taken up by white blood cells via their scavenger receptor. Cholesterol-engorged white blood cells are called **foam cells**, which are primary constituents of atherosclerotic plaques. As a result, **LDLs** are often referred to as "bad cholesterol."

High-Density Lipoprotein (HDL) - carries excess cholesterol from tissue to the liver for metabolism or excretion ([Figure 18.7](#)). Also referred to as "good cholesterol" because it removes cholesterol from the blood and returns it to the liver.

See also: [Lipoprotein Complexes](#), [Apo\(lipo\)proteins](#), [Familial Hypercholesterolemia \(FH\)](#), [Atherosclerosis](#)

INTERNET LINK: [Lipid Transport](#)

Intermediate Density Lipoprotein Complexes (IDLs)

IDLs are lipoprotein complexes that carry lipids in the bloodstream. **IDLs** are derived from VLDLs and can be converted into LDLs (See [Figure 18.7](#)). **IDLs** are composed of the following apoproteins:

[Apo B-100](#), [Apo C-I](#), [Apo C-II](#), [Apo C-III](#), [Apo E](#)

See also: [Lipoproteins](#), [Cholesterol](#), [LDL](#), [VLDL](#), [Lipoprotein Complexes in Fat Transport](#)

Foam Cells

Oxidative damage to LDLs in the bloodstream stimulates production of a class of white blood cells that bind to the damaged LDL and absorb them in a process similar, but not identical to receptor mediated endocytosis. Since LDLs contain a good deal of cholesterol and cholesterol uptake by these cells is virtually unlimited, the cells become filled with cholesterol. These cholesterol-engorged immune cells are referred to as "**foam cells**".

See also: [Receptor Mediated Endocytosis](#), [Atherogenesis](#), [LDL](#), [Cholesterol](#), [Scavenger Receptor](#)

Atherogenesis

Atherogenesis is the process by which **atherosclerotic plaques** form, a critical step in the disease, **atherosclerosis**.

Low-density lipoprotein complexes (**LDLs**), which are the primary means of transporting **cholesterol** in the blood, are readily oxidized. These oxidations include peroxidation of unsaturated fatty acids, hydroxylation of cholesterol, and oxidation of amino acid residues in the apoprotein. A class of white blood cells recognizes the oxidation and absorbs the LDL through its scavenger receptor. After a white blood cell has absorbed numerous LDLs containing cholesterol, it becomes engorged and is referred to as a foam cell. **Foam cells** attract other white blood cells, which leads to accumulation of more cholesterol. Ultimately, this accumulation of cholesterol becomes one of the chief chemical constituents of the **atherosclerotic plaque** that forms at the site.

See also: [**Apolipoproteins**](#),

INTERNET LINK: [**Cardiovascular Pathology**](#)

Scavenger Receptor

The **scavenger receptor** is a specialized receptor on the surface of white blood cells that binds to oxidized LDLs in the process of engorging the LDL. Unlike the LDL receptor, the **scavenger receptor** is not down-regulated by cholesterol, so these white blood cells can take up an almost unlimited amount of cholesterol. This converts them into foam cells.

See also: [LDL](#), [LDL Receptor](#), [Cholesterol](#), [Foam Cells](#)

Pancreatic Lipase

Pancreatic lipase is an enzyme found in intestinal mucosal cells that digests triacylglycerols to a mixture of free fatty acids, glycerol, monoacylglycerols, and diacylglycerols. The enzyme requires calcium and is unusual in catalyzing its reaction at an oil-water interface ([Figure 18.6](#)).

See also: [Triacylglycerols](#), [Fatty Acids](#), [Figure 18.4](#), [Glycerol](#), [Monoacylglycerol](#), [Diacylglycerol](#)

Lovastatin

Lovastatin is a drug used to lower cholesterol levels. **Lovastatin** is an inhibitor of **HMG-CoA reductase**, the major regulatory enzyme in cholesterol biosynthesis that catalyzes the committed step in cholesterol and other isoprenoid syntheses.

See also: , [Cholesterol](#), [Cholesterol Biosynthesis](#)

INTERNET LINKS:

1. [Sterol Biosynthesis](#)
 2. [Terpenoid Biosynthesis](#)
-

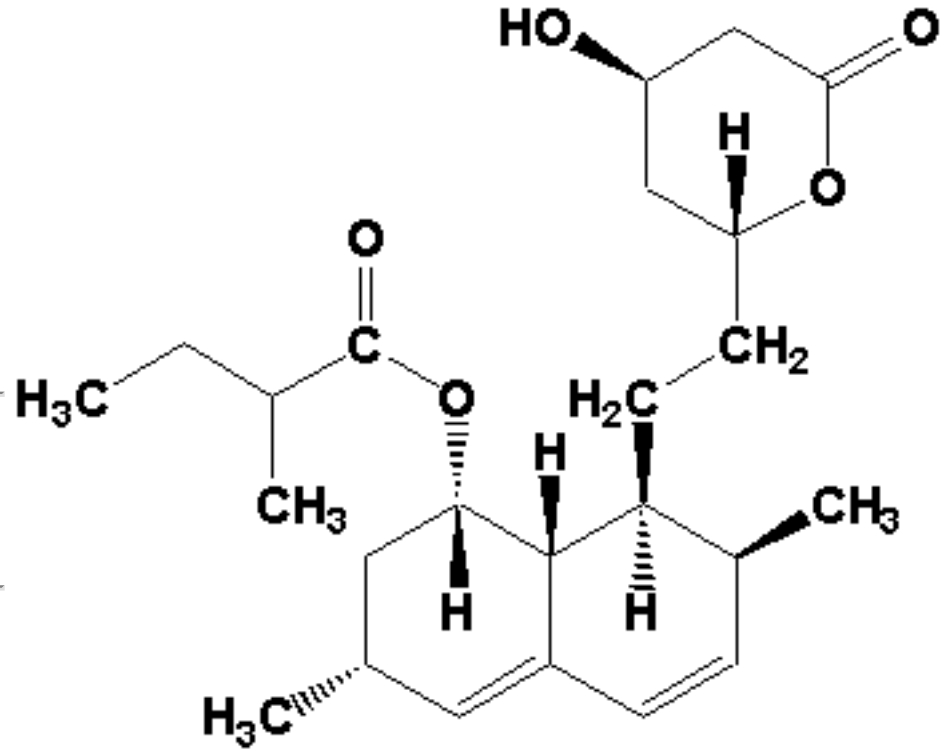

Lovastatin

Apoprotein B-48 (Apo B-48)

Apo B-48 is a protein of molecular weight 241,000 found exclusively in chylomicrons ([Table 18.1](#)). Coding for **Apo B-48** derives from the N-terminal region of Apo B-100.

See also: [Table 18.2](#), [LDL](#), [IDL](#), [VLDL](#), [Lipoproteins](#), [Apoproteins](#), [Chylomicrons](#), [Apo B-100](#)

INTERNET LINK: [Lipid Transport](#)

Figure 18.5: Generalized structure of a plasma lipoprotein.

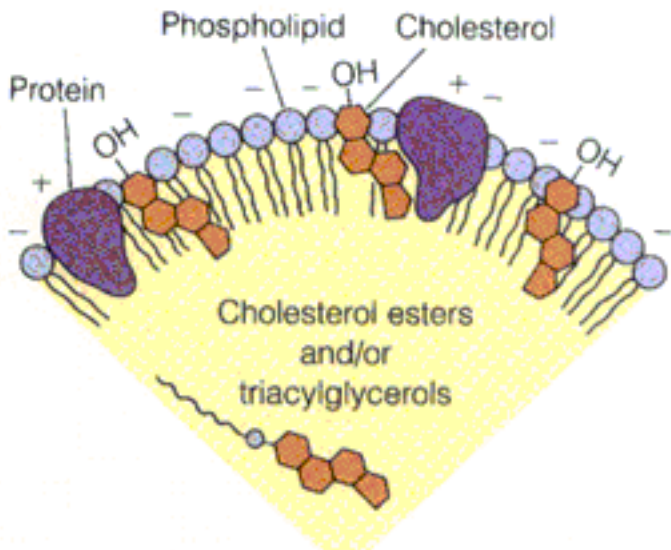

Light Absorbing Pigments

In order to capture energy from light, cells need pigments that absorb light efficiently in the visible and near-infrared portions of the spectrum. The light absorbing portions of these **pigments** are called chromophores. Structures of a few common chromophores are shown in [Figure 17.7](#). [Figure 17.8](#) shows that chromophores absorb light that completely spans the visible spectrum.

[Chlorophyll a](#) and [chlorophyll b](#) are the most abundant **pigments** in higher plants. Both **pigments** are related to [protoporphyrin IX](#) of [hemoglobin](#) and [myoglobin](#). One important difference is that the metal bound in chlorophylls is Mg^{2+} versus Fe^{2+} in the blood proteins.

Chlorophylls are located in the thylakoid membranes of the chloroplast.

Chlorophylls a and b absorb deep blue and red light strongly ([Figure 17.8](#)). The reflected light (the light not absorbed) is (green) and is what we see when we look at most plants. The other colors of plants arise from the colors of accessory pigments. Loss of chlorophylls in the autumn allows the accessory **pigments** (and nonphotosynthetic pigments) of leaves to become apparent.

Some photosynthetic bacteria use **pigments** that absorb wavelengths in the near infrared portion of the spectrum.

See also: [Light Gathering Structures](#), [Energy of Light](#), [The Chloroplast](#), [Photosystem II](#), [Photosystem I](#), [Thylakoid Membranes](#), [Porphyrin and Heme Metabolism](#) (from Chapter 21)

INTERNET LINK: [Photosynthetic Pigments](#)

Figure 17.8: Absorption spectra and light energy.

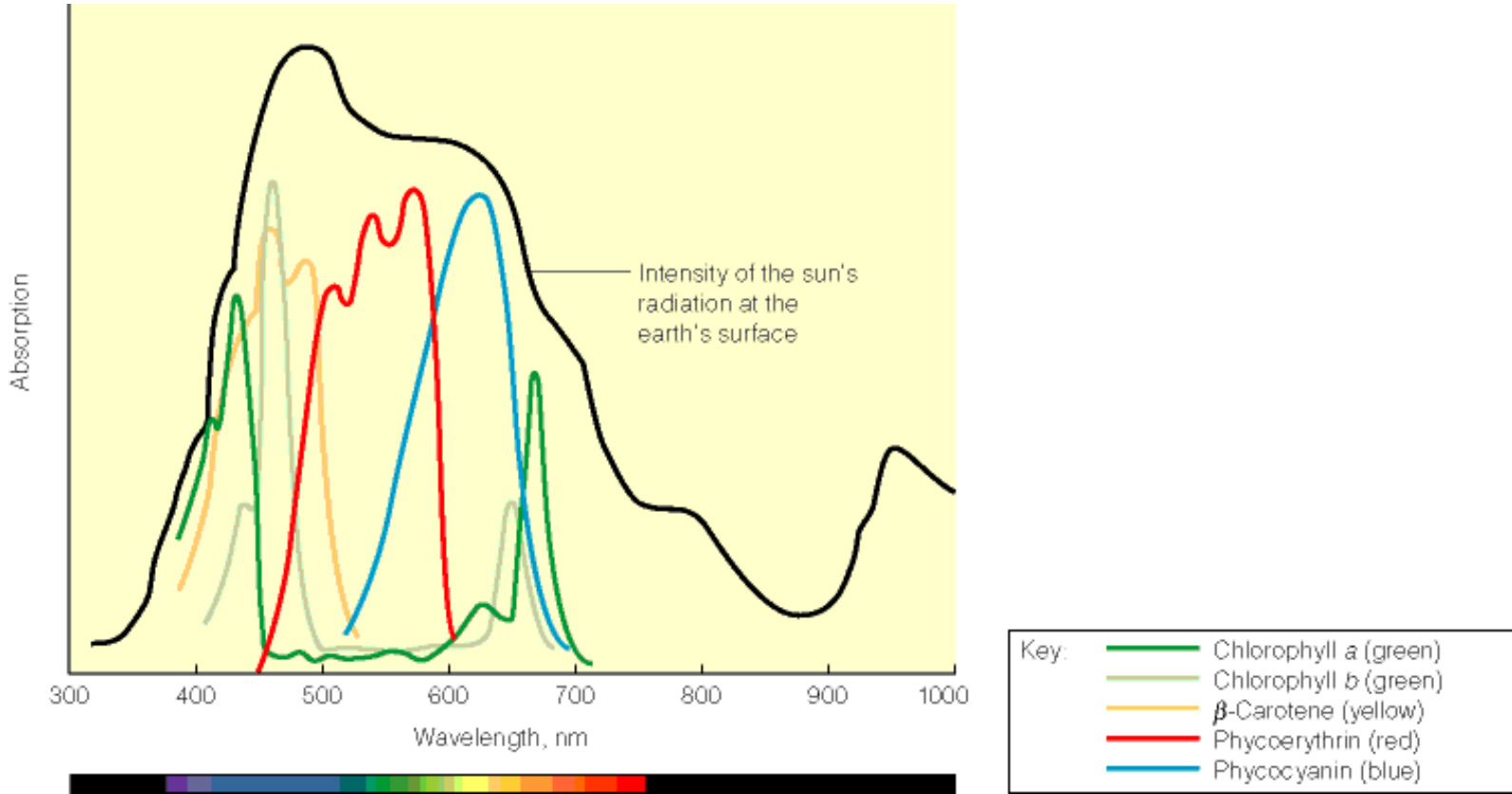

Chlorophyll a

Chlorophyll a and chlorophyll b are the most abundant plant pigments.

Chlorophylls a and b are found in higher plants and algae. Bacteriochlorophylls differ slightly in structure.

Chlorophylls a and b are related to the protoporphyrin IX found in **hemoglobin** and **myoglobin**.

However, the bound metal in the chlorophylls is Mg^{2+} rather than Fe^{2+} .

In **Figure 17.7c**, the accessory pigments β -carotene and phycocyanin are also shown.

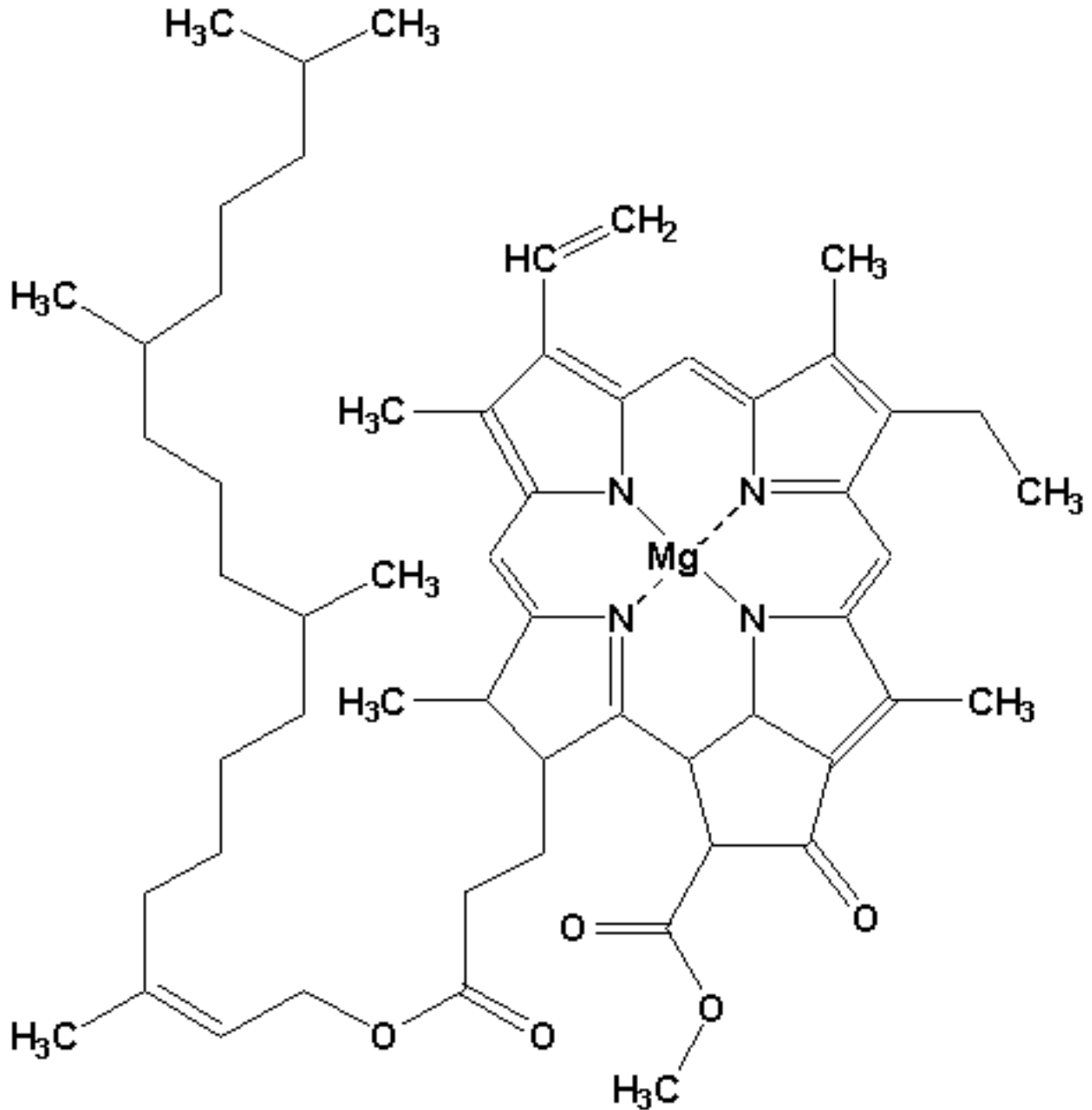

Chlorophyll A

All of these molecules absorb light in the visible region of the spectrum because they have large conjugated double-bond systems. Because **chlorophylls a** and b absorb strongly in both the deep blue and red, the light that is not absorbed but reflected from chloroplasts is green, the color we associate with most growing plants. The other observed colors, such as the red, brown, or purple of algae and photosynthetic bacteria, are accounted for by differing amounts of accessory pigments. Loss of chlorophylls in autumn leaves allows the colors of the accessory pigments, as well as nonphotosynthetic pigments, to become evident. Some photosynthetic bacteria use pigments that absorb wavelengths up to about 1000 nm, in the near infrared.

See also: [Chlorophyll](#), [Chlorophyll b](#), [Protoporphyrin IX](#), [Figure 17.8](#), [\$\beta\$ -Carotene](#), [Chloroplasts](#)

INTERNET LINKS:

1. [Porphyrin and Chlorophyll Metabolism](#)
 2. [Photosynthetic Pigments](#)
-

Chlorophyll b

Chlorophyll a and **chlorophyll b** are the most abundant plant pigments. **Chlorophylls b** and a are found in higher plants and algae. Bacteriochlorophylls differ slightly in structure.

Chlorophylls a and b are related to the protoporphyrin IX found in **hemoglobin** and **myoglobin**.

However, the bound metal in the chlorophylls is Mg^{2+} rather than Fe^{2+} . In **Figure 17.7c**, the accessory pigments β -carotene and phycocyanin are also shown.

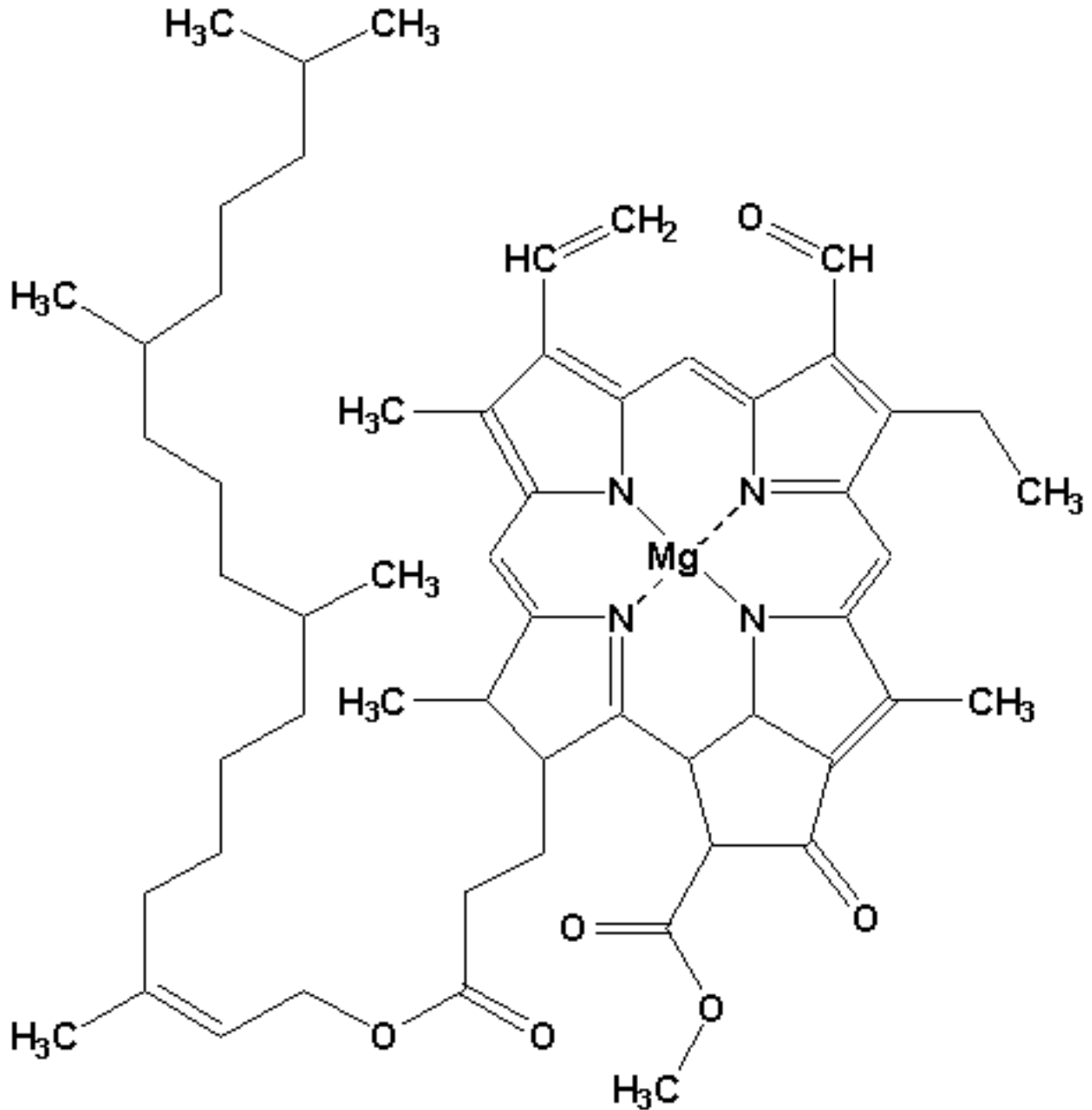

Chlorophyll B

All of these molecules absorb light in the visible region of the spectrum because they have large conjugated double-bond systems. Because **chlorophylls b** and a absorb strongly in both the deep blue and red, the light that is not absorbed but reflected from chloroplasts is green, the color we associate with most growing plants. The other observed colors, such as the red, brown, or purple of algae and photosynthetic bacteria, are accounted for by differing amounts of accessory pigments. Loss of chlorophylls in autumn leaves allows the colors of the accessory pigments, as well as nonphotosynthetic pigments, to become evident. Some photosynthetic bacteria use pigments that absorb wavelengths up to about 1000 nm, in the near infrared.

See also: [Chlorophyll](#), [Chlorophyll b](#), [Protoporphyrin IX](#), [Figure 17.8](#), [\$\beta\$ -Carotene](#), [Chloroplasts](#)

INTERNET LINKS:

1. [Porphyrin and Chlorophyll Metabolism](#)
 2. [Photosynthetic Pigments](#)
-

Light Gathering Structures



The thylakoid membranes of the chloroplast hold the **chlorophyll** and some of the **accessory pigments**. Their membranes contain only a small fraction of the common phospholipids, but are rich in glycolipids. They also contain much protein, and some of the photosynthetic pigments are attached to certain of these proteins.

Chlorophylls a and **b** are not attached to proteins, but interact with both membrane lipids (through their phytol tails) and proteins.

The assemblies of **light-harvesting pigments** in the thylakoid membrane together with their associated proteins, are organized into well-defined photosystems, structures that absorb light photons and convert some of it into a chemical form.

The first part of the process occurs in **light-harvesting complexes**. Each multisubunit protein complex contains multiple **antenna pigment molecules**, **chlorophylls** and some **accessory pigments**, and two **chlorophyll** molecules that act as the reaction center. The reaction center traps energy quanta excited by the absorption of light.

Absorption of light by a molecule excites it from the ground state to a higher electronic state. With **photosynthetic pigments**, the excited electron occupies a π orbital in the system of conjugated double bonds of the porphyrin. The excitation energy in photosynthesis is harvested in two ways:

1. Resonance or exciton transfer (**Figure 17.9a**) - transfer of energy to an identical molecule. In this case, the first molecule retains the photon and returns to the ground state after the energy is transferred.
2. Electron transfer (**Figure 17.9b**) - transfer of an electron to a nearby molecule with a slightly lower excited state, making molecule I a cation and molecule II an anion.

Resonance transfer is important for the way **chlorophylls** function in cells. Only about 1 O₂ molecule is produced for every 2500 **chlorophylls**. Instead, most of the **chlorophyll** molecules act as antenna molecules of the light-harvesting complexes. Antenna molecules absorb photons and the energy is passed by resonance transfer to specific **chlorophyll** molecules in a relatively few reaction centers. The path the energy takes to arrive at the energy center is random (**Figure 17.11**).

Chlorophylls in the reaction center are in a somewhat different environment, so the excited state energy of the reaction center is a bit lower. Excitation of the reaction center begins the actual photochemistry of the light reactions via a series of electron transfers.

See also: [Light Absorbing Pigments](#), [Chloroplast Anatomy](#), [Photosystem II](#), [Photosystem I](#), [The Chloroplast](#), [Chlorophyll](#), [Chlorophyll a](#), [Chlorophyll b](#)

Figure 17.9: Two modes of energy transfer following photoexcitation.

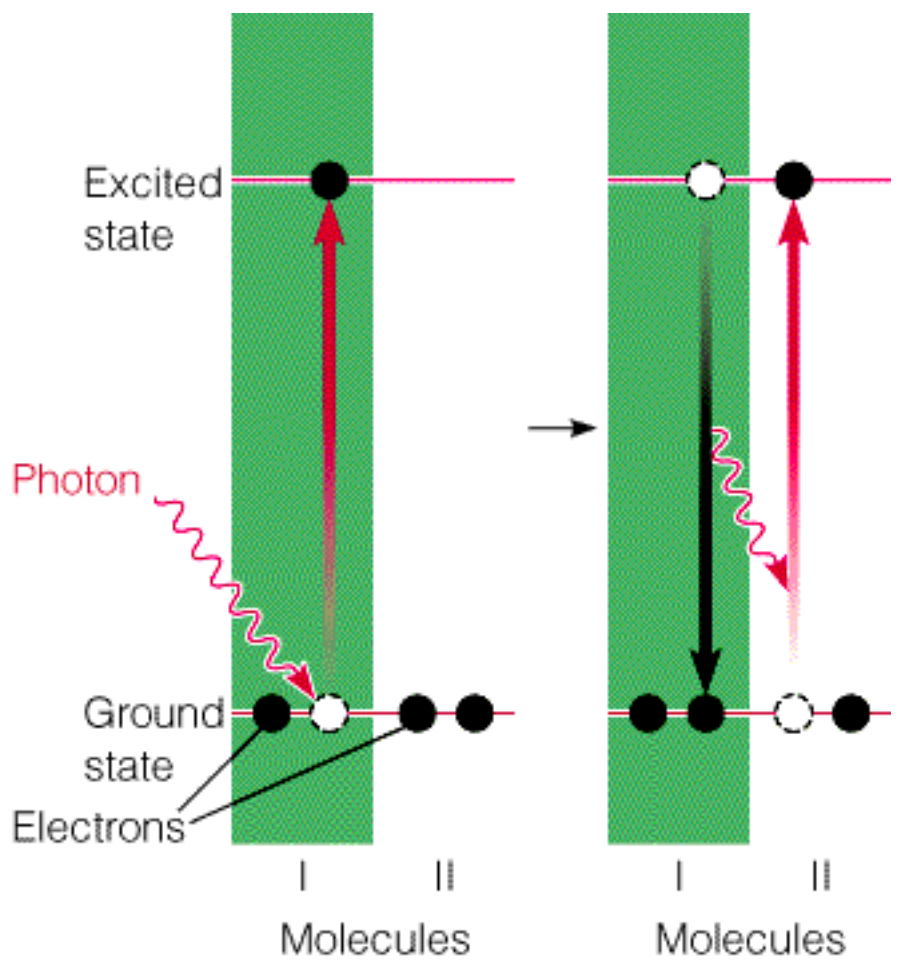

(a) Resonance transfer

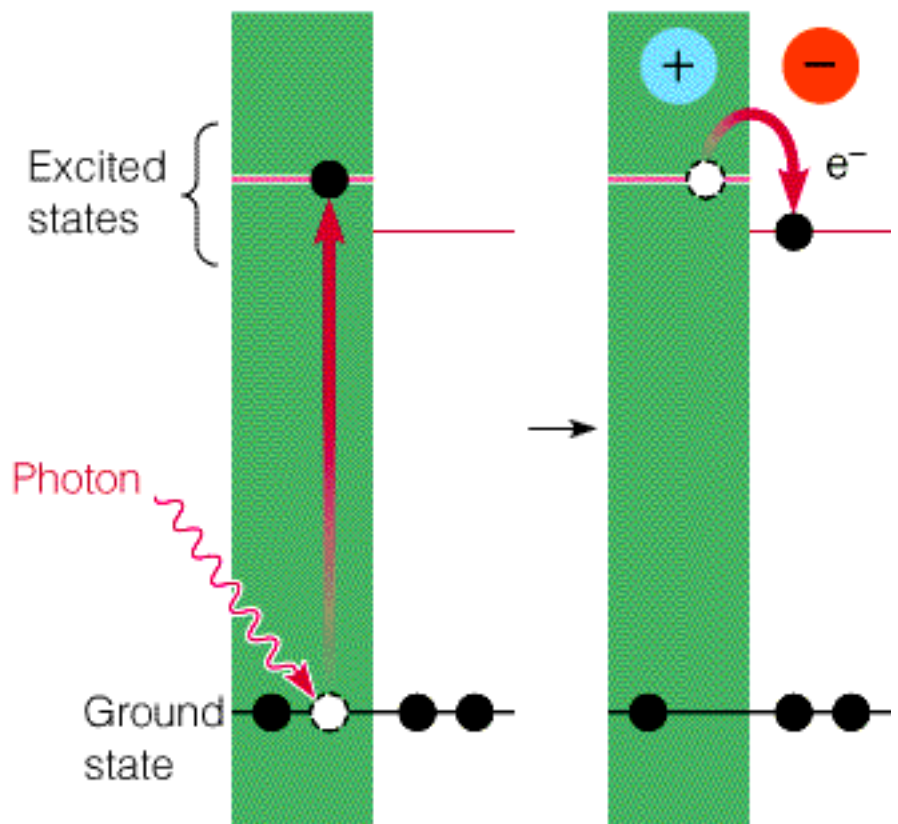

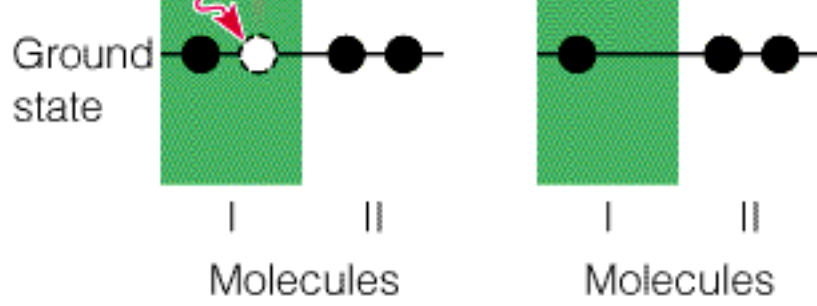

(b) Electron transfer

The Energy of Light

From quantum mechanical theory, we observe that

$$\nu = c/\lambda,$$

where λ is the wavelength of light, ν is its frequency, and c is the speed of light in a vacuum. The energy per photon is given by Planck's law,

$$E = h\nu,$$

where E is the energy and h is Planck's constant (6.626×10^{-34} J s). [Figure 17.6](#) shows the energy per mole of photons (one einstein) versus wavelength. The range of sensitivity of photosynthetic pigments is shown, as is the vibrational energy of molecules and a few common covalent bonds. Note also that the range of sensitivity of photosynthetic pigments corresponds to the span of wavelengths received at the surface of the Earth ([Figure 17.8](#)).

Photosynthesis depends primarily on light in the visible and near-infrared regions of the spectrum. Light of shorter wavelengths can break covalent bonds and is thus too strong to be practical for use in photosynthesis. Also, ultraviolet light can penetrate only a very short distance into water and is thus unavailable to photosynthetic organisms living in the sea. Wavelengths longer than visible light (i.e., infrared radiation), on the other hand, contain too little energy to be of much use for photosynthesis.

See also: [Light Absorbing Pigments](#), [Light Gathering Structures](#)

INTERNET LINK: [The Physics of Photosynthesis](#)

UDP-Galactose

UDP-Galactose is involved in the synthetic reaction to make N-acetyl- β -lactosamine, catalyzed by **galactosyltransferase**.

UDP-Galactose + N-Acetylglucosamine \rightleftharpoons **UDP + N-Acetyl- β -Lactosamine**

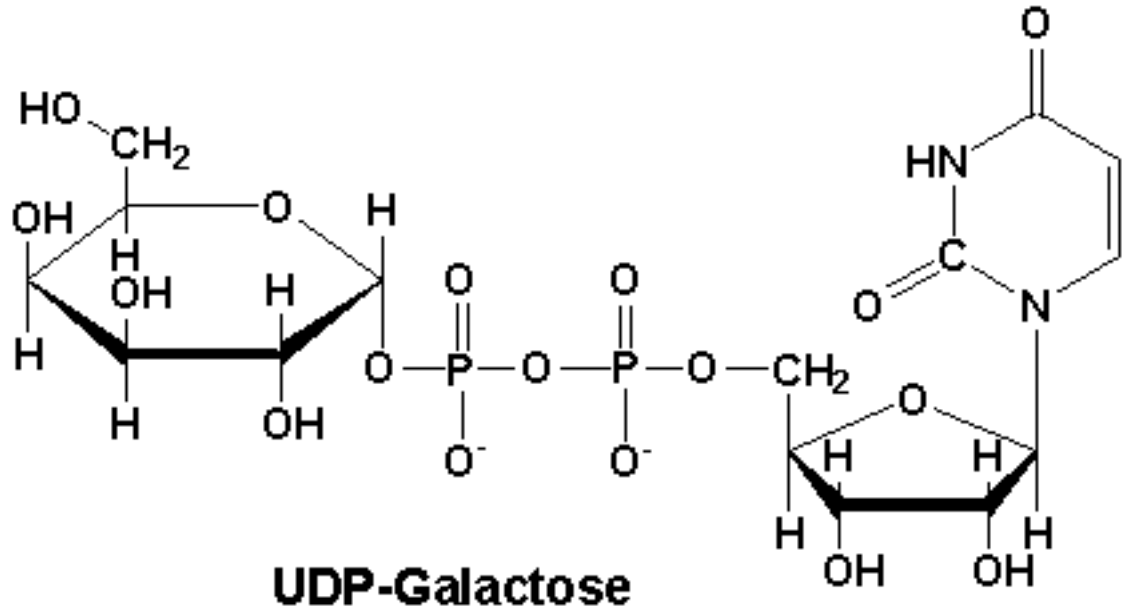

See also: [Figure 11.26](#),
[Figure 9.17](#)

Figure 11.26: Proposed mechanism for UDP-galactose epimerase.

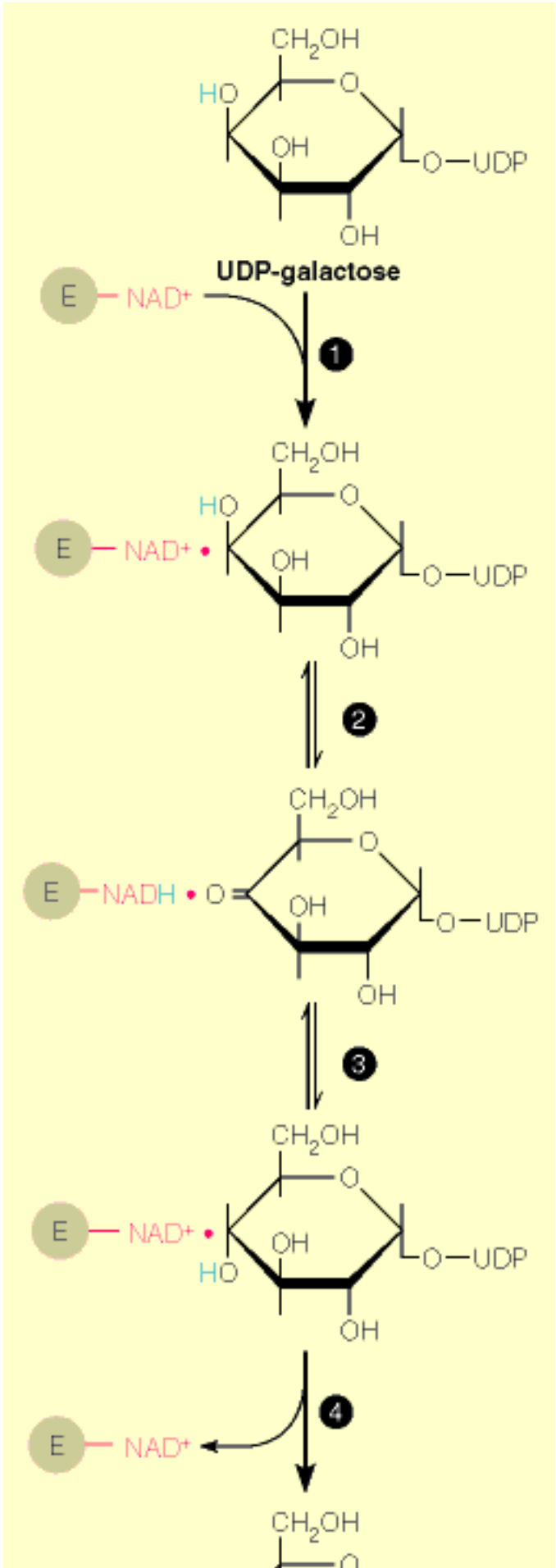

E - NAD⁺

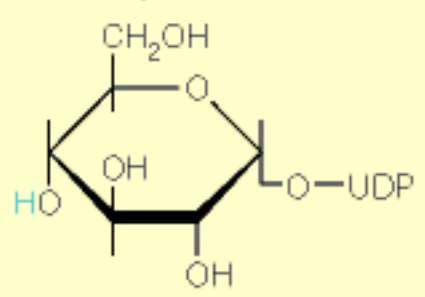

UDP-glucose

Oligosaccharides and Polysaccharides as Cell Markers

Oligosaccharides play a role in cell recognition/identity. **Oligosaccharides** form the blood group antigens. In some cells, these antigens are attached as O-linked glycans to membrane proteins. Alternatively, the **oligosaccharide** may be linked to a lipid molecule to form a glycolipid. These oligosaccharides determine the blood group types in humans ([Figure 9.29](#)). There are actually 14 genetically characterized blood group systems with more than 100 different blood group antigens.

Molecules of the blood group antigens represent only a special case of a much more general phenomenon - **cell marking** by **oligosaccharides** ([Figure 9.30a](#)). In multicellular organisms, different kinds of cells must be marked on their surfaces so that they can interact properly with other cells and molecules. The surface of many cells are nearly covered with **polysaccharides**, which are attached to either proteins or lipids in the cell membrane. Some animal cells have an extremely thick coating of **polysaccharides** called a glycocalyx.

For **oligosaccharides** or **polysaccharides** to serve as recognition signals, there must be proteins that bind to them specifically. One such class is the **immunoglobulins**. Another very diverse group of saccharide-binding proteins is the lectins. In plants, lectins appear to play defensive roles and aid in adhering nitrogen-fixing bacteria to roots. In animals, lectins seem to be involved in interactions between cells and proteins of the intercellular matrix, such as collagen, and help to maintain tissue and organ structure.

The cell surfaces of many cancer cells are abnormal, which may account for the loss in tissue specificity that such cells commonly exhibit.

Properties of oligosaccharides that aid in their role as **cellular markers**:

They can present a wide variety of structures in relatively short chains. The multiple possible monomers, linkages, and branching patterns allow a vast, but specific vocabulary.

They are very potent antigens (antibodies can be elicited swiftly against them)

See also: [Saccharides](#), [Monosaccharides](#), [Antibody Structure](#), [Antigens](#), [Biosynthesis of Glycoconjugates](#) (from Chapter 16)

Figure 9.30a: Cell surface recognition factors.

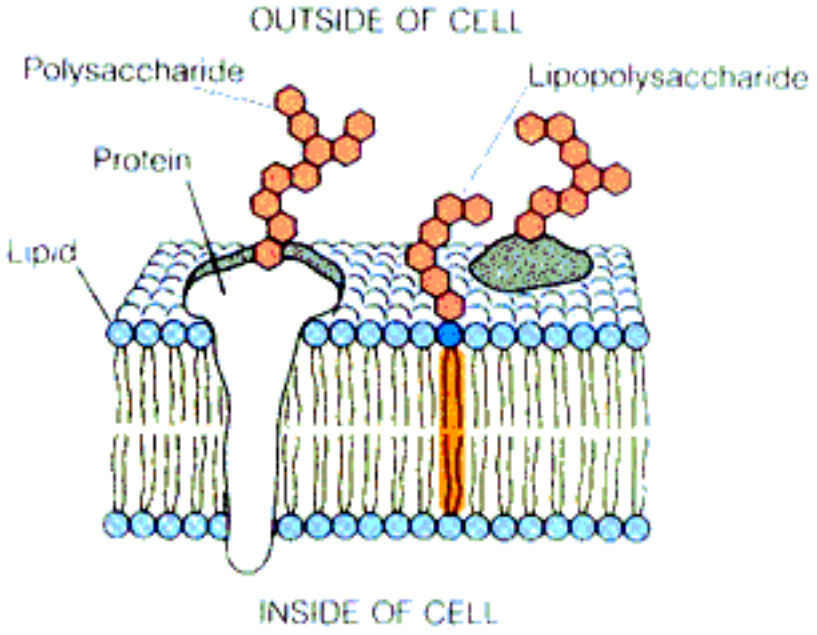

(a) Cell surface oligosaccharides

Immunoglobulins

The immune response is our first line of defense against infection and probably against cancer cells as well. Substances that elicit an immune response are called antigens, and a specific **immunoglobulin** that binds to this substance is called an antibody. If the invading particle is large, like a cell, a virus, or a protein, many different antibodies may be elicited, each type binding specifically to a given antigenic determinant (or epitope) on the surface of the particle ([Figure 7.29a](#)). The major types of **immunoglobulin** molecules are listed below:

IgA - An immunoglobulin found in bodily secretions, including saliva, sweat, tears, and along the walls of the intestines. It is the major antibody of colostrum, the initial secretion from a mother's breasts after birth.

IgD - An immunoglobulin found on the surface of B cells.

IgE - An immunoglobulin associated with some of the body's allergic responses.

IgG - An immunoglobulin also known as gamma-globulin. It is the most abundant of circulating antibodies (see [Figure 7.33](#)).

IgM - An immunoglobulin produced during the early response to an invading microorganism that is the largest immunoglobulin. It contains 5 Y-shaped units of two light and two heavy chains each.

See also: [Antibody Structure](#), [The Immune Response](#), [T Cells and the Cellular Response](#), [Clonal Selection Theory](#), [Antigens](#)

INTERNET LINKS:

1. [The Latest in Antibody News](#)
 2. [Antibody Resource Page](#)
-

Mechanisms of Protein Mutation

Mutation Mechanisms - When organisms copy their **DNA**, mistakes are occasionally made. These mistakes may be random errors that occur during copying, or they may be the result of damage the DNA has sustained from radiation or chemical mutagens, substances that produce mutations (**Table 7.1**). These alterations will appear as mutations in the DNA of the next and subsequent generations. There are two basic kinds of changes in the DNA sequence that may give rise to mutations in proteins.

1. Replacement of DNA Bases by Others - Replacement of bases in a section of DNA encoding a gene can have several possible consequences.

a. The base change may not affect the protein sequence at all. The change may occur in an **intron** or other region of the DNA that does not code for protein. But even if it is in a protein-coding region (exon), the replacement will make no difference in the protein sequence if the new codon codes for the same **amino acid** as the original one. The redundancy of the genetic code (see **here**) is such that fairly frequently a base change does not alter the amino acid sequence of the protein product.

b. An amino acid residue in the original protein may be replaced by a different one in the mutated protein; this type of replacement is called a **missense mutation** (**Figure 7.21a**).

c. If the **codon** for an amino acid residue within the original protein is changed to a **stop codon**, the protein will be terminated prematurely and usually will be nonfunctional (**Figure 7.21b**). This is called a **nonsense mutation**.

d. Sometimes the opposite happens—a stop codon mutates into a codon for an amino acid residue. In this case translation continues past the original stopping point, elongating the chain until the next stop codon is encountered.

Base substitutions may, in some cases, be neutral in effect, either not changing the amino acid coded for or changing it to another that functions equally well at that position in the protein. More often, the result is deleterious. Nonsense mutations, for example, almost always result in destruction of protein function. Occasionally mutations due to base substitutions increase the efficiency of a protein. When they do, the organism having the mutation may have a survival advantage over those that don't, allowing it to pass on the mutation to subsequent generations. This is one way that organisms adapt and evolve.

2. Deletions or Insertions of Bases in the Gene - Deletions or insertions in the gene may be large or small. Large insertions or deletions in coding regions almost invariably prevent the production of useful protein. The effect of short deletions or insertions depends on whether they involve multiples of three bases.

a. Deletion or insertion in a coding region of any number of bases other than a multiple of three has a drastic effect: It causes a shift in the reading frame during translation, resulting in a meaningless change in the amino acid sequence in the C-terminal direction from the point of mutation ([Figure 7.21c](#)). Such **frameshift mutations** are sometimes called **gibberish mutations** because the amino acid sequence is usually rendered meaningless.

b. Insertion or deletion of multiples of three bases do not affect coding of the protein outside the site of the insertion or deletion. Instead, the consequence is the deletion or addition of a corresponding number of amino acid residues. This may or may not affect the function of the protein made from the sequence.

Frameshift mutations almost always result in destruction of protein function.

By accumulating many small mutations over millions of years, proteins gradually evolve. The diversity of functions that they can collectively perform is increased by two other phenomena:

Gene Duplications - On rare occasions, events in a cell lead to a situation where two copies of the same gene are present. If there is no selective pressure, the two copies may evolve independently. One copy may continue to express the protein fulfilling the original function, but the other may evolve through mutations into an entirely different protein with a new function.

Gene Rearrangements - Fusion of two or more initially independent genes leads to the production of multidomain proteins exhibiting new combinations of functions in a single protein. Intervening sequences in eukaryotic genes (introns) are not used for coding, so they are places where genes can be easily cut and recombined in the process of genetic recombination. The mechanisms of recombination are described [here](#). If an exon from one gene, which codes for a protein region with physiological function B, is inserted into an intron region in a gene for a protein carrying function A, the new hybrid protein is capable of both functions A and B and may serve a new physiological function.

Through the combined effects of **mutations**, **gene duplication**, and **genetic rearrangement**, organisms can develop new proteins. The process of organismal evolution is largely a consequence of this molecular evolution of proteins.

See also: [Evolution of Myoglobin/Hemoglobin Proteins](#), [Hemoglobin Variants](#), [Thalassemias](#), [Generation of Antibody Diversity](#)

Table 7.1



Substance	Formula	Source	Effects
Benzo[a]pyrene		Smoke	Intercalates in DNA, causes frameshifts; also is metabolized to a product which binds to residues, causing base substitutions.
Nitrous acid	$\text{HO}-\text{N}=\text{O}$	Some prepared foods	Deaminates C to U, leads to missense
Dimethyl nitrosamine		Some prepared foods	Methylating agent, modifies bases, yields missense (see Chapter 25)
Aflatoxin		Moldy nuts or grains	Alkylating agent, modifies guanine, causes missense
Ultraviolet light		Sunlight	Causes the formation of pyrimidine dimers (see Chapter 25)

Figure 5.16: The genetic code.



		Second position					
		U	C	A	G		
U	UUU	Phe	Ser	UAU	UGU	U	
	UUC					UCC	UAC
	UUA	UCA		UAA	UGA	A	
	UUG	UCG		UAG	UGG	G	
C	CUU	Leu	Pro	CAU	CGU	U	
	CUC					CCC	CAC
	CUA			CCA	CAA	CGA	A
	CUG			CCG	CAG	CGG	G
A	AUU	Ile	Thr	AAU	AGU	U	
	AUC					ACC	AAC
	AUA			ACA	AAA	AGA	A
	AUG			ACG	AAG	AGG	G
G	GUU	Val	Ala	GAU	GGU	U	
	GUC					GCC	GAC
	GUA			GCA	GAA	GGA	A
	GUG			GCG	GAG	GGG	G

UAA

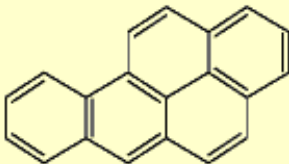
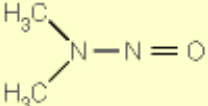
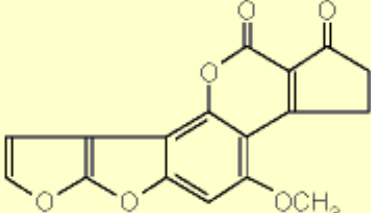

In the [genetic code](#), **UAA** is a stop codon. It is known as the ochre [codon](#).

See also: [Stop codons](#), , [UAG](#), [UGA](#)

UAG



In the genetic code, **UAG** is a stop codon. It is known as the amber codon.

See also: Stop codons, UAA, UGA

UGA



In the [genetic code](#), **UAG** is a stop codon. It is known as the opal [codon](#).

See also: [Stop codons](#), [UAA](#), [UAG](#)

One and Three Letter Amino Acid Codes

1 Letter	3 Letter	Name	Genetic Code
A	Ala	<u>Alanine</u>	GCA, GCC, GCG, GCU
C	Cys	<u>Cysteine</u>	UGU, UGC
D	Asp	<u>Aspartic Acid</u>	GAU, GAC
E	Glu	<u>Glutamic Acid</u>	GAU, GAC
F	Phe	<u>Phenylalanine</u>	UUU, UUC
G	Gly	<u>Glycine</u>	GGU, GGC, GGA, GGG
H	His	<u>Histidine</u>	CAU, CAC
I	Ile	<u>Isoleucine</u>	AUU, AUC, AUA
K	Lys	<u>Lysine</u>	AAA, AAG
L	Leu	<u>Leucine</u>	CUU, CUC, CUA, CUG, UUA, UUG
M	Met	<u>Methionine</u>	AUG
N	Asn	<u>Asparagine</u>	AAU, AAC
P	Pro	<u>Proline</u>	CCU, CCC, CCG, CCA
Q	Gln	<u>Glutamine</u>	CAA, CAG
R	Arg	<u>Arginine</u>	CGU, CGC, CGA, CGG, AGA, AGG
S	Ser	<u>Serine</u>	UCU, UCC, UCA, UCG, AGU, AGC
T	Thr	<u>Threonine</u>	ACU, ACC, ACA, ACG
V	Val	<u>Valine</u>	GUU, GUC, GUA, GUG
W	Trp	<u>Tryptophan</u>	UGG
Y	Tyr	<u>Tyrosine</u>	UAU, UAC

See also: [The Genetic Code](#)

Figure 7.21: Mutation types.

Residue number	1	2	3	4	5	6	7	8	9	10	
Normal β gene	...A T G G T G Val	C A C His	C T G Leu	A C T Thr	C C T Pro	G A G Glu	G A G Glu	A A G Lys	T C T Ser	G C C Ala	...
(a) Missense mutation	G T G Val	C A C His	C T G Leu	A C T Thr	C C T Pro	G T G Val	G A G Glu	A A G Lys	T C T Ser	G C C Ala	...
(b) Nonsense mutation	G T G Val	C A C His	C T G Leu	A C T Thr	C C T Pro	G A G Glu	G A G Glu	T A G Stop	T C T Ser	G C C Ala	...
(c) Frameshift mutation by deletion	G T G Val	C A C His	C T G Leu	A C C Thr	C C T Leu	G A G Arg	G A G Arg	A A G Ser	T C T Leu	G C C Ala	...

Recombination

Genetic diversity in a species is maintained through both mutation and **recombination**. Mutation alters single genes or small groups of genes in an individual, whereas **recombination** redistributes the contents of a genome among various individuals during reproduction. In classical biology, **recombination** is the outcome of crossing over between paired sister chromosomes during meiosis in eukaryotes. Strictly speaking, **recombination** is any process that creates end-to-end joining from two different DNA molecules. Thus, the daughter-strand gap repair process (see [here](#)) is a form of **recombination**.

Meiotic **recombination** in diploid organisms requires extensive sequence homology between the recombining partners and is called homologous **recombination**. This term also describes certain **recombinational** events between bacterial chromosomes. Most bacterial homologous **recombination** processes share a common requirement for the RecA protein or its counterpart.

New DNA can be introduced into a bacterial cell by the following processes:

1. **Conjugation** during bacterial mating;
2. **Transformation**, when DNA is taken up by cells; and
3. **Transduction**, when bacterial DNA that was accidentally packaged into a phage particle is introduced by infection.

Site-specific **recombination**, by contrast, involves only limited sequence homology between recombining partners. Sites of breaking and joining are determined by specific DNA--protein interactions. Integration of bacteriophage λ into the host bacterial chromosome occurs by a site-specific **recombination** mechanism ([Figure 25.17](#)). The **RecA protein** of *E. coli* is not required for this process. Rather, the virus makes a site-specific enzyme, called integrase, and specific DNA - protein interactions between the enzyme and the recombining partners (rather than extensive DNA - DNA sequence homology) determine the site of **recombination**.

Two other forms of **recombination** are the following:

1. **Transposition**, which involves neither sequence homology nor the RecA protein, but does require a special sequence on the donor DNA.
 2. Illegitimate **recombination**, an extremely rare event that may occur by chance, involves neither sequence homology nor the action of any known protein. [Table 25.3](#) summarizes the main distinctions among the four major types of recombination.
-

See also: [Homologous Recombination](#), [Site-Specific Recombination](#), [Transposable Genetic Elements](#), [Generating Antibody Diversity](#), [Gene Rearrangements](#), [Mechanisms of Protein Mutation](#) (Chapter 7)

INTERNET LINK: [The Recombination Pages](#)

Figure 25.17: Site-specific recombination, establishing lysogeny in bacteriophage λ .

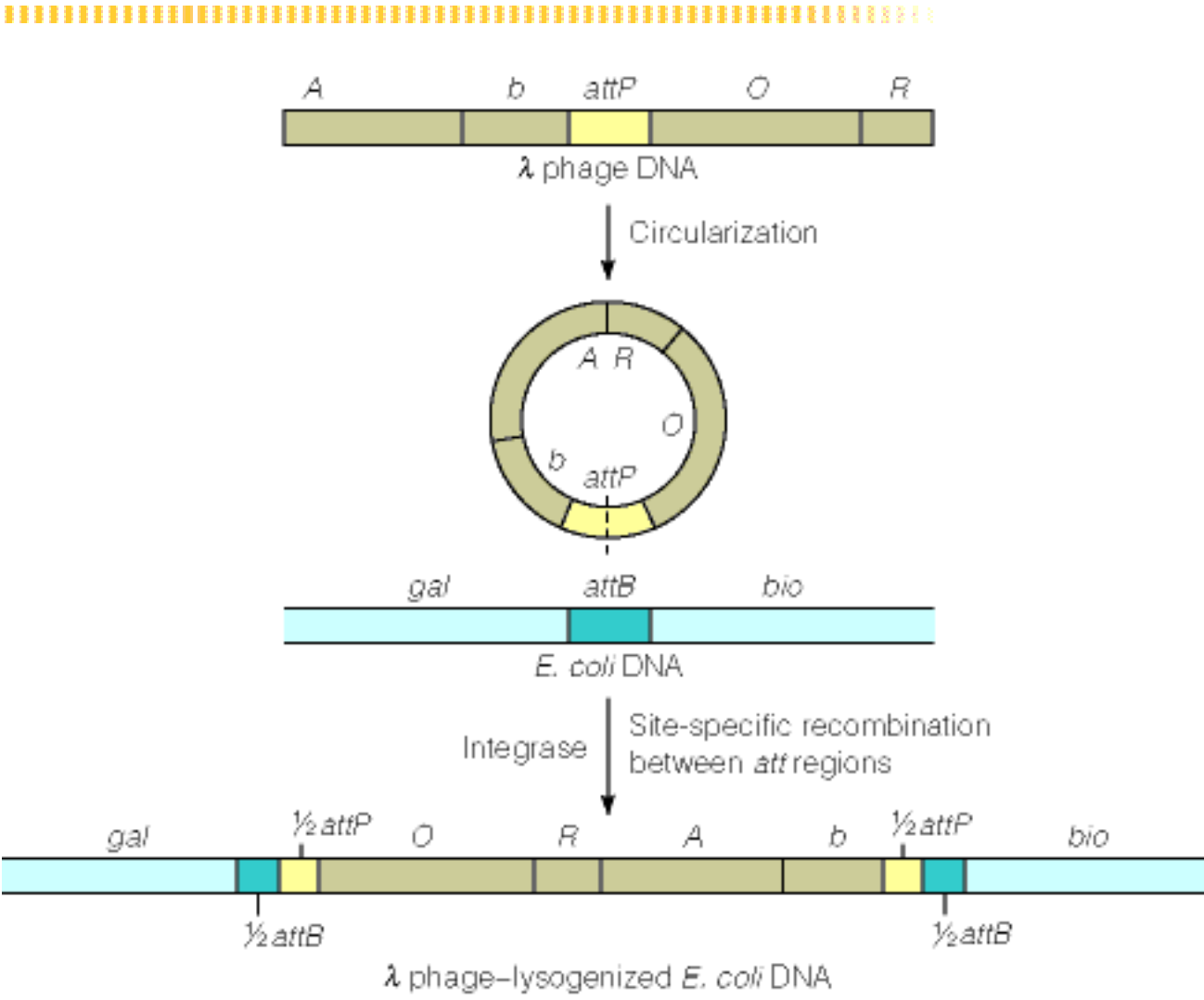

Terminology



5,10-Methenyltetrahydrofolate - A molecule that acts like 8-hydroxy-5-deazaflavin in DNA photolyases. It acts as a light harvesting factor.

5-Methylcytosine - The only methylated base found in eukaryotic DNA

6-4 Photoproduct - A structure in DNA of a covalent link made between carbon #4 of the 3' pyrimidine and carbon #6 of an adjacent 5' pyrimidine. It occurs as a result of exposure to UV light. It can lead to mutation during replication. [Figure 25.9](#).

8-Hydroxy-5-deazaflavin - A molecule that acts like 5,10-methenyltetrahydrofolate in DNA photolyases. It acts as a light harvesting factor.

8-Oxoguanine - An oxidized form of guanine arising from oxidative damage.

attB - A locus in the *E. coli* chromosome targeted by the bacteriophage λ for site-specific recombination. [Figure 25.31](#).

attP The site on the λ chromosome involved in site-specific recombination with the *E. coli* chromosome. [Figure 25.31](#).

Base Excision Repair - Cellular DNA repair system that cleaves the glycosidic bond connecting a damaged base to the DNA sugar-phosphate backbone.

BRCA-1 - A gene associated with an increased risk of breast and ovarian cancer that is involved in transcription-coupled excision repair.

Chi - An octanucleotide sequence in *E. coli* (5'-GCTGGTCC-3') recognized by exonuclease V. At this sequence, the exonuclease switches strands and its preferred polarity of DNA degradation. This facilitates the loading of RecA to a free 3' end and initiates strand invasion of a nearby duplex. [Figure 25.28](#)

Chromophore - A structural moiety that absorbs light of characteristic wavelengths. [Figure 25.10](#)

Clonal Expansion - A mechanism by which large-scale production of specific antibodies occurs. The B and T cells produced by the body have randomly generated antigen specificities. When a particular antigen enters the body, it induces proliferation only in B and T cells that happen to be specific for it. Thus, the antigen selects the cells that will mount an immune response against it and stimulates them to undergo clonal proliferation.

Cyclobutane Pyrimidine Dimer - A structure in DNA of two covalent bonds made between adjacent

pyrimidine residues as a result of exposure to UV light. The two new bonds form a four-membered ring and can lead to mutation during replication if not repaired. [Figure 25.9](#)

DNA Photolyase - An enzyme that repairs cyclobutane pyrimidine dimers in the presence of visible light. [Figure 25.10](#).

Excinuclease - A term used to describe the enzymatic cutting of DNA by the uvrABC system.

Exonuclease V (also called RecBCD nuclease) - A protein in *E. coli* recombination that binds at a double-strand break on duplex DNA and uses a helicase activity to unwind and partially degrade the DNA. It helps to load RecA to a 3' end. [Figure 25.28](#)

Gene Amplification - Selective amplification of a specific region of a genome

Heteroduplex - A double stranded DNA in which the two strands were not made from each other and came from other molecules. [Figure 25.19](#)

Holliday Junction - An intermediate during homologous recombination; a four-armed structure in which each of the participating DNA duplexes has exchanged one strand with the other duplex. [Figure 25.20](#)

Holliday Model - A model for homologous recombination involving alignment of homologous sequences, nicking, strand invasion, ligation, migration of the cross point (Holliday Junction), isomerization, breaking of strands, and rejoining. A variation of the model was proposed by Meselson and Radding. [Figure 25.20](#)

Homogeneously Staining Region - A region of a chromosome that lacks the typical chromosome banding pattern. It can be produced by gene amplification.

Homologous Recombination - Genetic recombination that requires extensive sequence homology between the recombining DNA molecules. Meiotic recombination by crossing over in eukaryotes is an example.

Illegitimate Recombination - An extremely rare type of recombination that possibly occurs by chance. It involves neither sequence homology nor the action of any known protein.

Immunoglobulin G (IgG) - An antibody of class 'G' containing two heavy chains and two light chains.

Maintenance Methylase - A eukaryotic enzyme that ensures that all of the methylated sites in the parental DNA are also methylated in the progeny DNA. [Figure 25.3](#)

Meselson -Radding Model - A proposed model for homologous recombination involving alignment of homologous sequences, nicking, strand displacement synthesis, strand invasion, loop cleavage, ligation of the displaced strand, isomerization, branch migration and ligation of the invading 'A' strand, and

resolution as in the Holliday model. [Figure 25.22](#)

Microsatellite Instability - Mutations consisting of repeats of single, double, and triple-nucleotide sequences which probably arise by 'slipping' of strands during DNA polymerization.

Mismatch Repair - Cellular DNA repair system that recognizes DNA mismatches created either by replication errors, non-homologous recombination, or damage to one DNA base, and corrects the error.

Mutagenesis - The process of creating mutations.

mutT - An *E. coli* gene that catalyzes the following reaction: $8\text{-oxo-dGTP} + \text{H}_2\text{O} \rightleftharpoons 8\text{-oxo-dGMP} + \text{PPi}$

Nucleotide Excision Repair - A process whereby a damaged section of a DNA chain is cut out, or excised, followed by the action of DNA polymerase and then DNA ligase to regenerate a covalently closed duplex at the site of the original damage.

O⁶-Alkylguanine Alkyltransferase - An unusual repair enzyme that transfers a methyl or ethyl group from an O⁶-methylguanine or O⁶-ethylguanine to a cysteine residue in the active site of the protein. It can thus, only function once.

Oncogenic Transformation - Conversion of a normal cell to a cancerous one.

Photoproducts - The products that result when light energy causes a chemical reaction to occur in a substance. With respect to DNA, the term refers to the types of damaged DNA that can be caused by uv irradiation.

Plaque - A cleared area on a Petri dish on a plate of bacteria arising from growth of a bacteriophage in that region.

Postreplication Repair - Processes that attempt to fix mismatches, gaps, or damage to DNA that escapes the repair process that occurs during replication

Prophage - The integrated, inactive λ chromosome in the *E. coli* genome.

Provirus - With respect to a retrovirus, a virus integrated into the host genome.

RecA - A multifunctional protein with Mr of about 38,000. In recombination it promotes the pairing of homologous strands. In the SOS response it also plays a role in gene activation. [Figure 25.23](#)

Recombination - A process in an organism in which two parent DNA molecules give rise to daughter DNA that combines segments from both parent molecules. It may involve the integration of one DNA molecule into another, the substitution of a DNA segment for a homologous segment on another DNA molecule, or the exchange of homologous segments between two DNA molecules.

Recombinational Repair - Cellular DNA repair system in which newly replicated DNA duplexes undergo genetic recombination, with ultimate removal of the damaged DNA segment.

Resolvase - An enzyme found in class II and class III type transposons that catalyzes site-specific recombination between the two elements of the transposon created by replicative transposition.

Restriction Endonucleases - Enzymes that catalyze the double-strand cleavage of DNA at specific base sequences.

Restriction/Modification - A defense system common in bacteria involving a restriction endonuclease and a site-specific methylase that methylates the same sequence the restriction endonuclease cuts at. Normally, the host DNA is methylated, which protects against the action of the restriction endonuclease, but invading viral DNA is not methylated, and is cut. [Figure 25.5](#)

Retrotransposon - A transposable element which goes through an RNA stage.

Retroviruses - A family of RNA viruses that possess reverse transcriptase. After the virus infects a cell, this enzyme transcribes the RNA genome into a double-strand DNA version, which integrates into a host chromosome. Human immunodeficiency virus (HIV) is an example.

ruvA - A protein involved in *E. coli* recombination. It is a DNA binding protein, whose specificity directs it toward the four-stranded Holliday structure

ruvB A protein involved in *E. coli* recombination. It is an ATP-requiring motor protein, which binds to two opposed arms of the Holliday junction and rotates them in opposite directions, forcing branch migration by driving the rotational movement of the other two strands toward the junction.

ruvC A protein involved in *E. coli* recombination. It begins resolution of the Holliday structure by nicking two strands.

Site-specific Recombination - Recombination that involves only limited sequence homology between recombining partners. Sites of breaking and joining are determined by specific DNA-protein interactions. [Figure 25.17](#)

Somatic Mutations - Mutations that occur in non-germline cells.

SOS Response - A bacterial response to various potentially lethal stresses, including severe UV irradiation. It involves the coordinated expression of a set of proteins that carry out survival maneuvers, including an error-prone type of repair for thymine dimers in DNA.

Strand Invasion - A process that is postulated to occur in homologous recombination in which an unpaired part of a strand of DNA invades a duplex region of another DNA.

Thymine Glycol - An oxidized form of thymine arising from oxidative damage.

Transition Mutation - A mutation that changes a purine-pyrimidine base pair to a different purine-pyrimidine base pair. An example is a transition from G-C to A-T.

Transposable Genetic Elements - DNA fragments containing genes that do not have a fixed location in a genome but can move from place to place within the genome, albeit with low frequency. [Figure 25.34](#).

Transposase - An enzyme involved in movement of a transposon from one DNA to another. It can make a staggered cut in a specific sequence in a target DNA into which the transposon moves.

Transposition - A type of recombination which involves neither sequence homology nor the RecA protein (in *E. coli*) but does require a special sequence on the donor DNA.

Transverse Mutation - A mutation that changes a purine-pyrimidine base pair to a different pyrimidine-purine base pair. An example is a transition from G-C to T-A.

Unequal Crossing Over - A recombinational process that can lead to multiple copies of a gene. It may be important in gene amplification.

uvrD - A helicase component of the *E. coli* nucleotide excision repair system.

Xis - A protein required in addition to Int and IHF to reverse the process by which λ was integrated into the *E. coli* genome.

Figure 25.31a: Integrative recombination in phage λ .

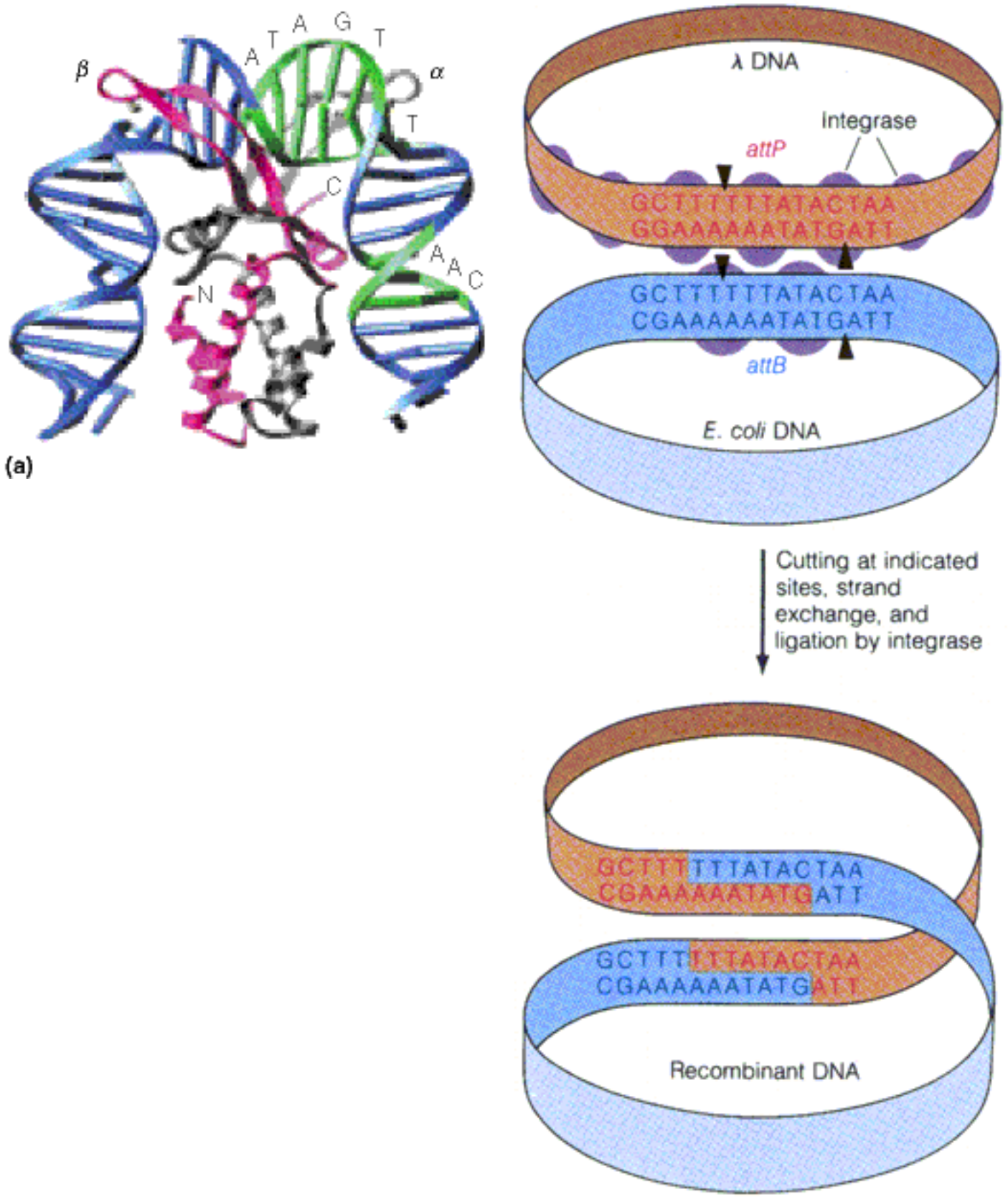

(a) Courtesy of P. A. Rice, S. Yang, K. Miznuchi, and H. A. Nash, Cell (1996) 87:1298.

Figure 25.28: A model for the action of RecBCD, Chi sites, and RecA in initiating homologous recombination.

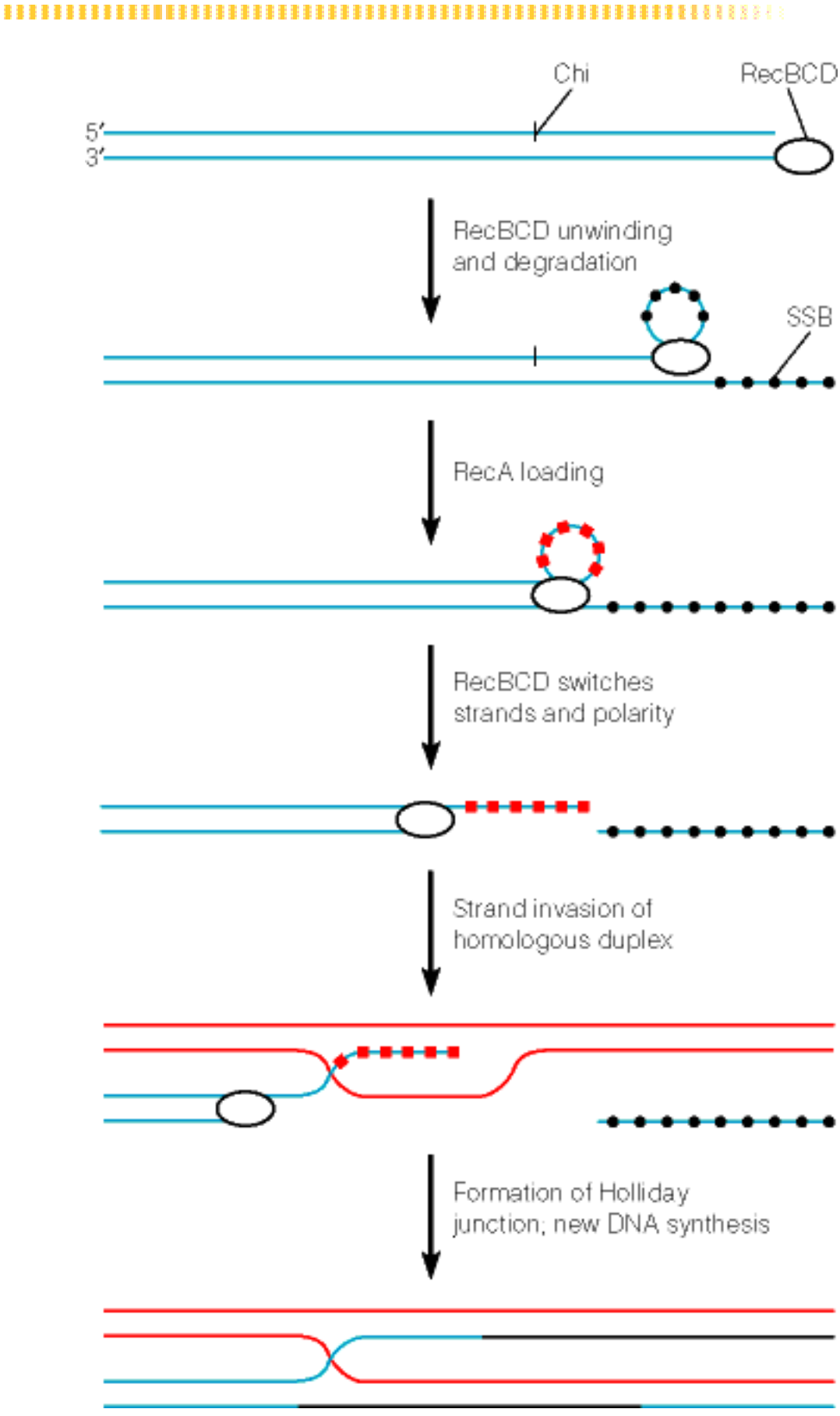

Redrawn from D. G. Anderson and S. C. Kowalczykowski, Cell (1997) 90:77-86.

Figure 25.19: Generation of progeny phage containing two genotypes by replication of heteroduplex DNA.

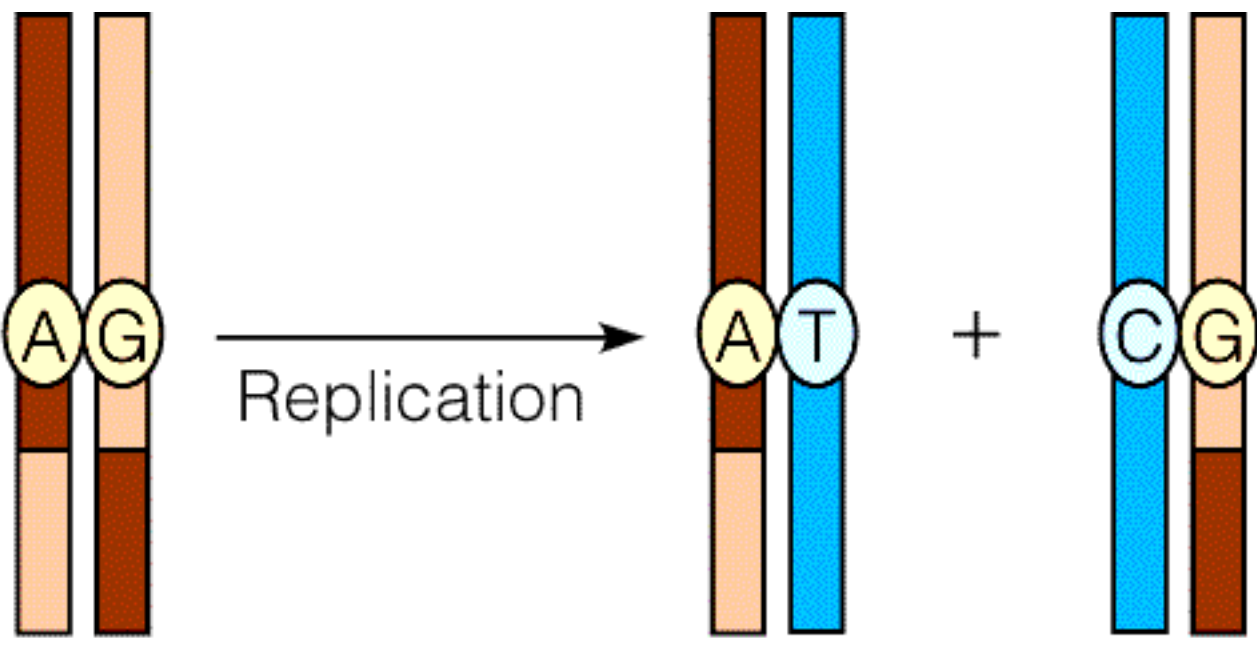

Heteroduplex DNA

Progeny DNA

Figure 25.20: The Holliday model for homologous recombination.

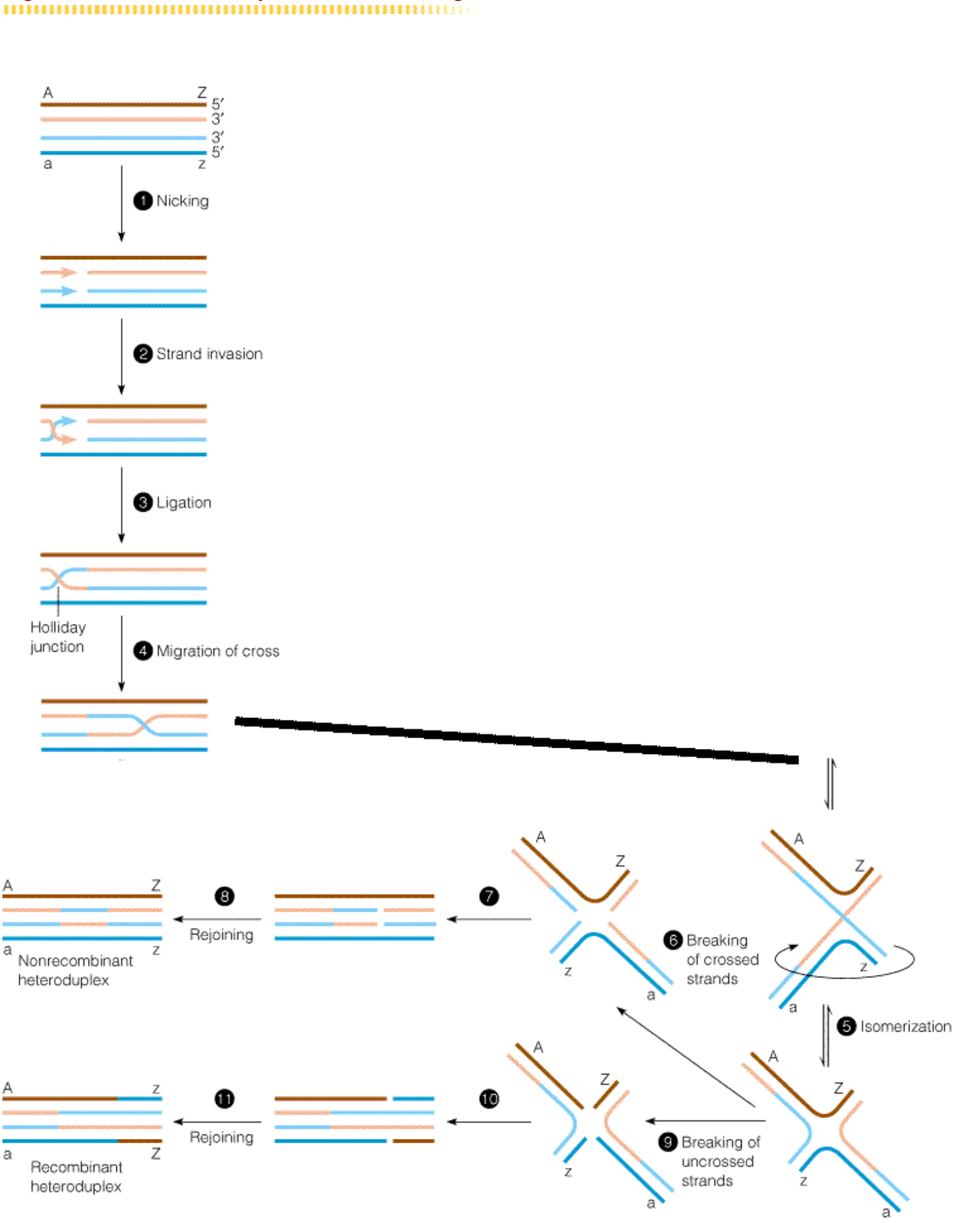

heteroduplex

z



strands

z



Figure 25.3: Maintenance methylation of eukaryotic DNA.

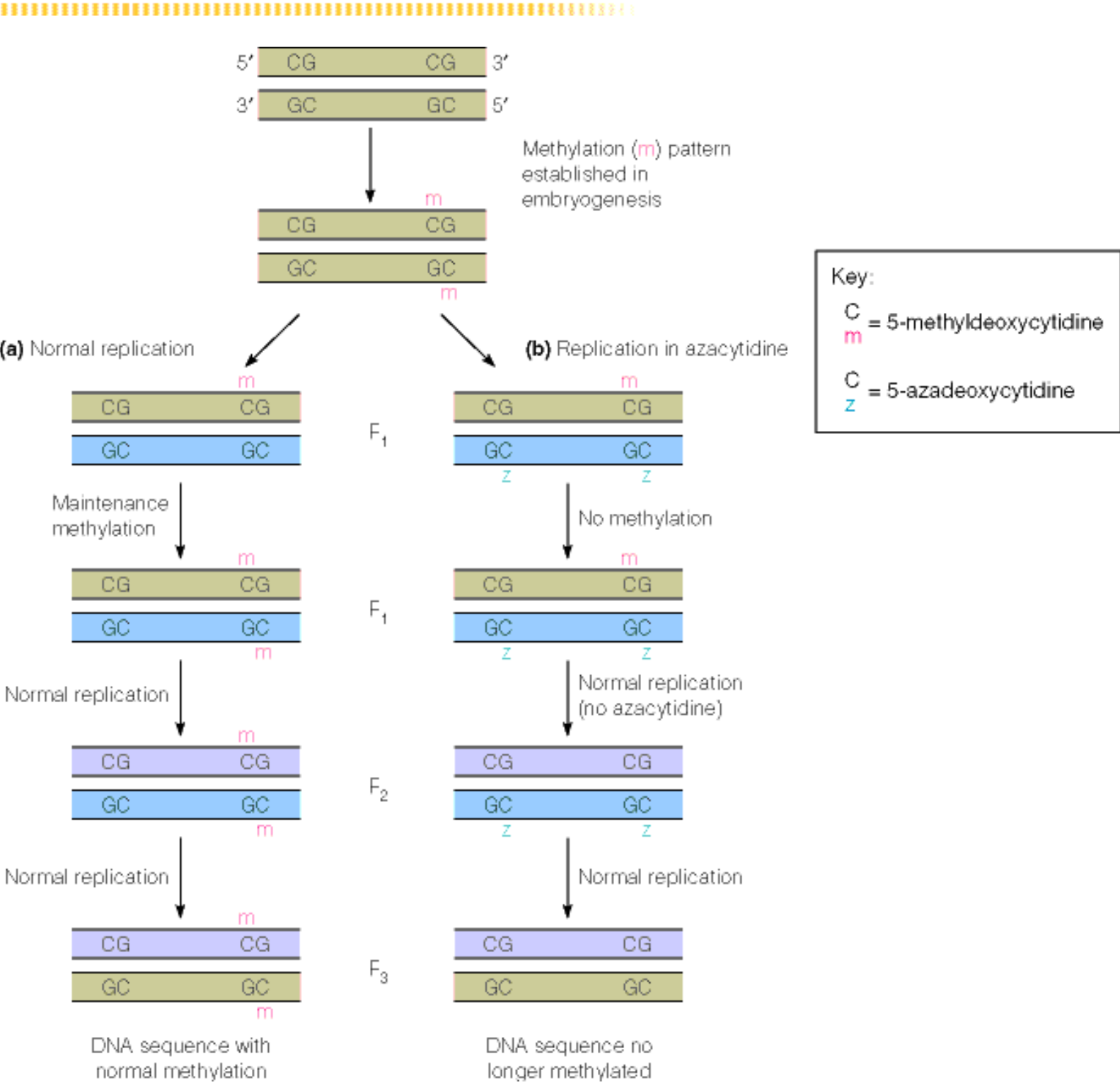
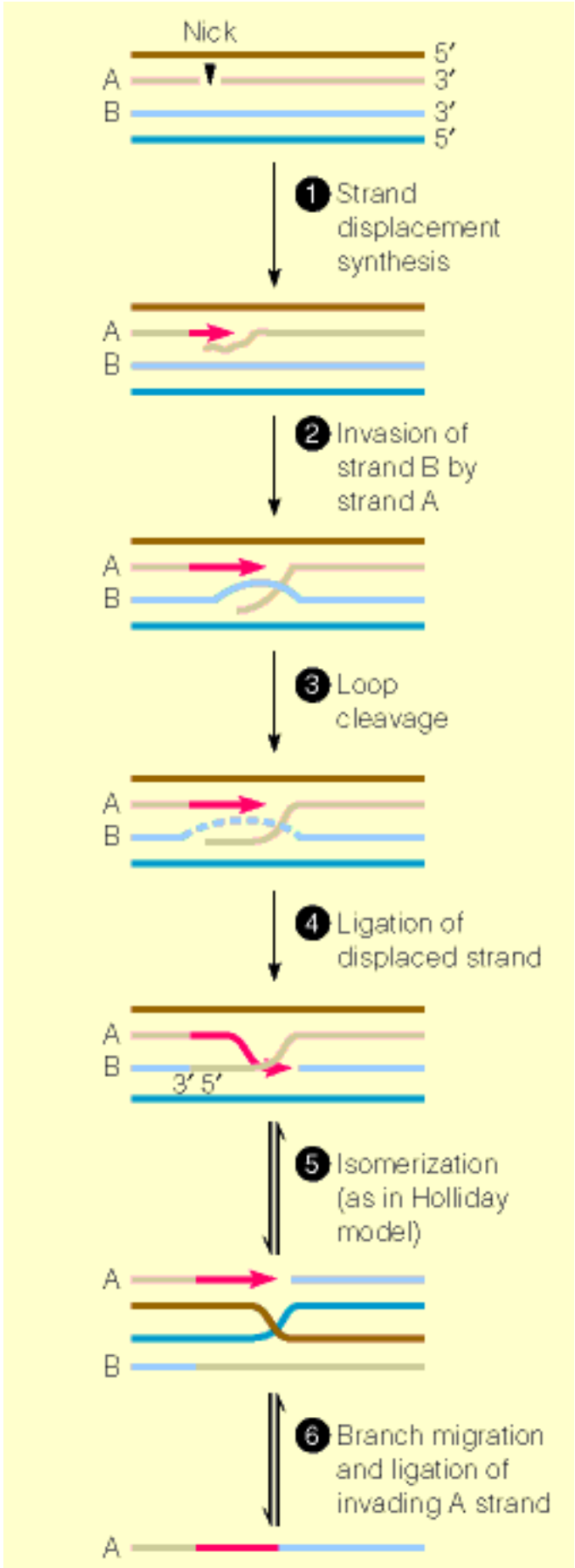

Figure 25.22: The Meselson-Radding model for homologous recombination.



6 Branch migration and ligation of invading A strand



7 Resolution as in Holliday model

Nonrecombinant heteroduplex

Recombinant heteroduplex

Figure 25.5: Host-induced restriction and modification.

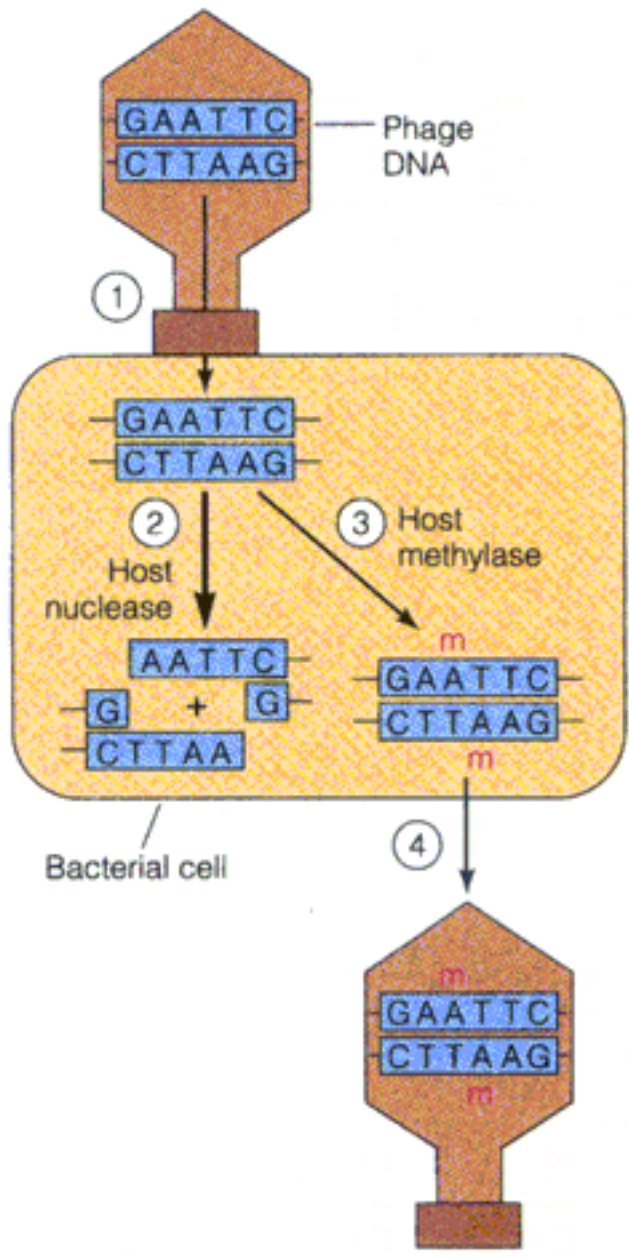

Figure 25.34: Genome rearrangements that can be promoted by homologous recombination between two copies of the same transposable element.

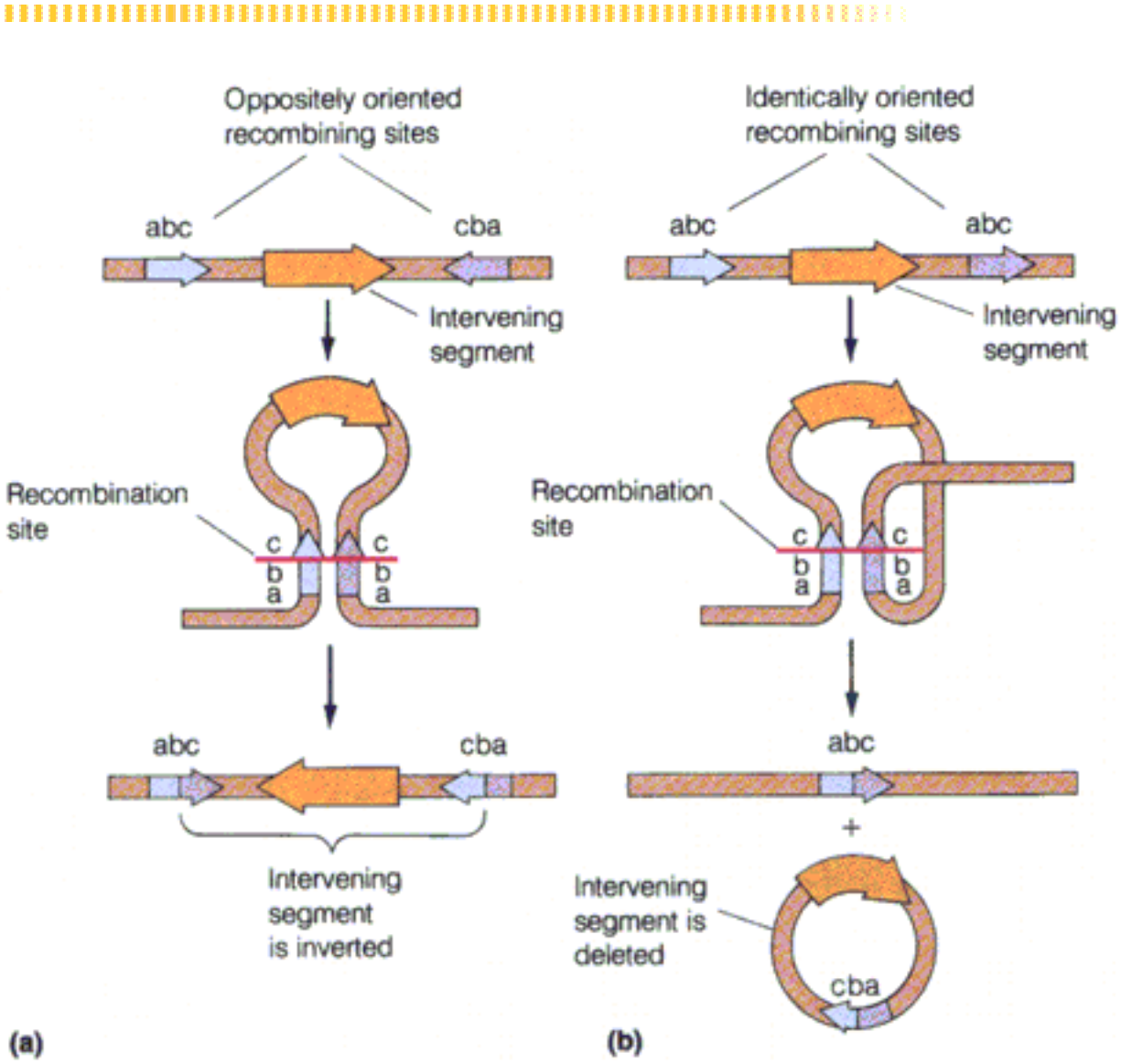

Table 25.3



Type	Requirement		
	Sequence homology	RecA protein or counterpart	Sequence-specific enzyme
Homologous	Yes	Yes	No ^a
Site-specific	Yes (about 15 bases)	No	Yes
Transposition	No	No	Yes
Illegitimate	No	No	Unknown

^aThe Chi site or its counterpart determines cutting sites (see page 951), but initial recognition of pairing sites occurs by sequence homology.

Homologous Recombination

The most straightforward way to accomplish recombination is to break and rejoin DNA molecules, a process called **homologous recombination**. In 1964 Robin Holliday proposed a model (detailed in [Figure 25.20](#)) for **homologous recombination** between duplex DNA molecules.

Holliday proposed that **recombination** proceeds as follows (with steps numbered according to [Figure 25.20](#)):

1. Nicking at the same site on two paired chromosomes;
2. Partial unwinding of the duplexes is followed by strand invasion, in which a free single-strand end from one duplex pairs with its unbroken complementary strand in the other duplex, and vice versa;
3. Enzymatic ligation generates a crossed-strand intermediate, called a Holliday junction;
4. The crossed-strand structure can move in either direction by duplex unwinding and rewinding;
5. The Holliday junction "resolves" itself into two unbroken duplexes, by a process of strand breaking and rejoining. The process leading to recombination begins with isomerization of the Holliday structure (step 5), followed by strand breakage;
- 6 - 8 . If the original crossed strands (those that were broken in step 1) break and rejoin, the products are nonrecombinant duplexes, each containing a heteroduplex region (that is, nonrecombinant with respect to the outside markers A and Z); and
- 9 - 11. If the strands that will break are those that were not broken in step 1, resolution of the resulting structure generates two chromosomes recombinant for DNA flanking the region and each containing a heteroduplex region.

A modification of the Holliday model, proposed by Meselson and Radding, is shown in [Figure 25.22](#). In it,

1. Strand displacement synthesis occurs;
2. A displaced single-strand end of the nicked duplex, A, invades the homologous region of the unbroken duplex, B;

3. The displaced loop on duplex B is cleaved and partially degraded;
4. The displaced end from duplex A is ligated to B; and
5. Isomerization then occurs, as in the Holliday model, with the originally unbroken strands crossed.

An additional feature of the Meselson - Radding model is branch migration, a process of simultaneous strand unwinding and rewinding of both duplexes, which allows the site at which the strands cross to move. As a result, the final cuts of these strands may occur some distance from the site of either strand invasion or the original nick (steps 6 and 7). In principle either a 5' or a 3' end could initiate the strand invasion process, but a 3' end probably initiates recombination in *E. coli*.

See also: [Recombination](#), [Proteins of Recombination](#)

INTERNET LINKS:

1. [Recombination via Holliday Junction](#)
 2. [Recombination Tutorial](#)
-

Proteins of Recombination

The Holliday and Meselson-Radding model of **recombination** ([here](#)) can easily be adapted to explain daughter strand gap repair or the **recombination** that occurs in bacteria after transformation or conjugation. Some of the proteins thought to participate in bacterial **recombination** include the following:

1. [DNA polymerase](#);
2. [DNA ligase](#);
3. [Single-strand DNA-binding protein](#);
4. [RecA protein](#)--a multifunctional protein with Mr of about 38,000. In **recombination** it promotes the pairing of homologous strands (see [here](#)). Several strand-pairing reactions can be demonstrated *in vitro*. Two examples are shown in [Figure 25.23](#). RecA binds just 3 DNA strands during the strand exchange reaction that it catalyzes. A model for the strand exchange reaction is shown in [Figure 25.24](#). In the process, RecA wraps single-stranded DNA ([Figure 25.23](#), [Figure 25.24](#)) and then examines double-stranded DNA for sequences complementary to those in the single strand by sliding the single stranded DNA along the double stranded DNA in a process that requires ATP. When complementarity is found, branch migration occurs, with simultaneous strand exchange;
5. Exonuclease V (also called RecBCD nuclease)--In *E. coli*, **recombination** occurs preferentially at or near the octanucleotide sequence, 5'-GCTGGTCC-3'. This sequence is called Chi. The RecBCD protein (a heterotrimer of the protein products of the *recB*, *recC*, and *recD* genes) displays sequence specificity for Chi. It binds at a double-strand break on duplex DNA and uses a helicase activity to unwind and partially degrade the DNA. The 3' end is displaced as a loop, which is coated with single strand binding protein. When the enzyme reaches Chi, a sequence-specific interaction causes RecBCD to switch strands and switch its preferred polarity of DNA degradation. These changes facilitate the loading of RecA to a free 3' end, which initiates strand invasion of a nearby duplex ([Figure 25.28](#));
6. *ruvA*--a DNA binding protein, whose specificity directs it toward the four-stranded Holliday structure;
7. *ruvB*--an ATP-requiring "motor protein," which binds to two opposed arms of the Holliday junction and rotates them in opposite directions, forcing branch migration by driving the rotational movement of the other two strands toward the junction; and
8. *ruvC*--begins resolution of the Holliday structure by nicking two strands.

Ruv protein homology has not yet been detected in eukaryotic cells, but much of the mechanism appears to be similar to that of *E. coli*. For example, the RAD51 protein of human cells and yeast has a strand-pairing activity similar to that of RecA.

In eukaryotic cells, an essential function of homologous **recombination** is the repair of double-strand breaks. A broken eukaryotic chromosome can use the sequence information in its homolog to reconstruct the original DNA sequence at the site of the break ([Figure 25.30](#)).

See also: [Recombination](#), [Homologous Recombination](#), [RecA / SOS Response](#)

INTERNET LINKS:

1. [Recombination via Holliday Junction](#)
-

Figure 25.30: A model for double-strand break repair via homologous recombination.

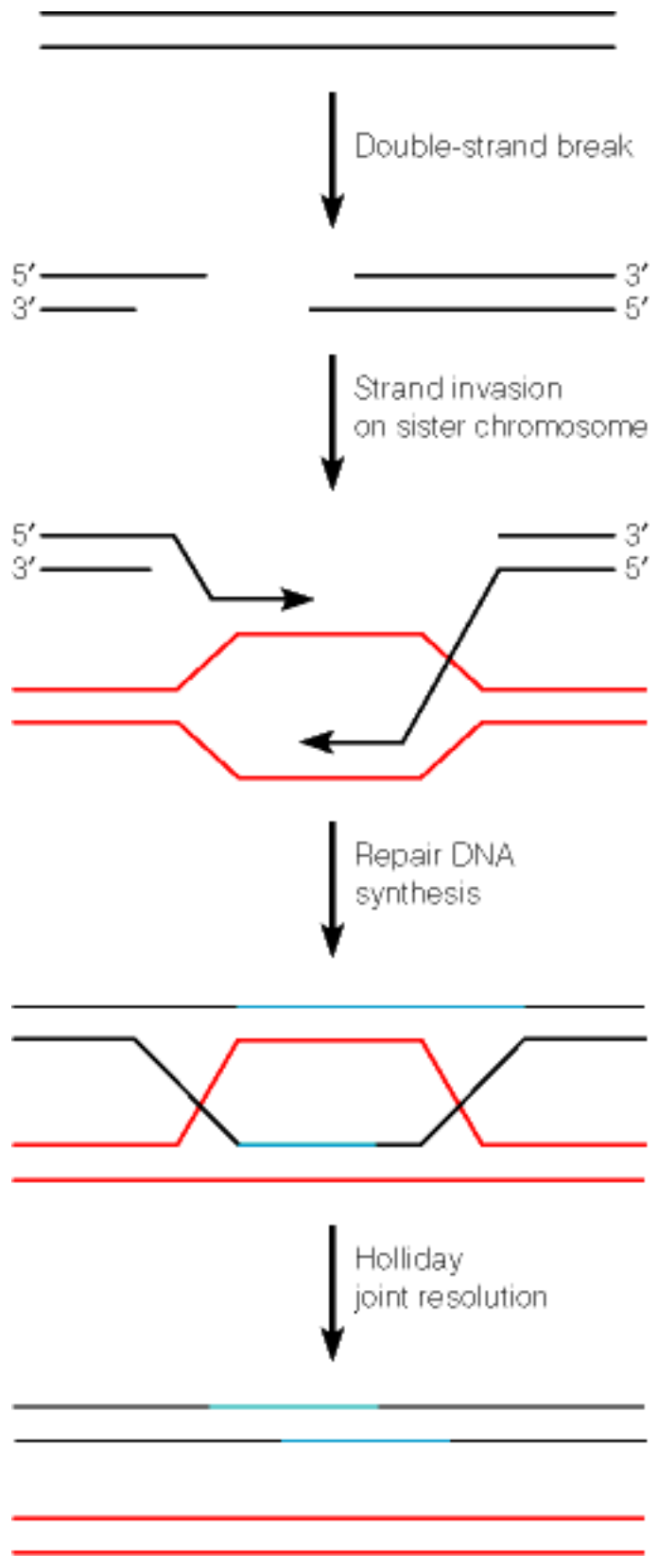

Redrawn from P. Baumann and S. C. West, Trends Biochem. Sci. (1998) 23:247-251. © 1991 with

permission of Elsevier Science.: Redrawn from P. Baumann and S. C. West, Trends Biochem. Sci. (1998) 23:247-251. © 1991 with permission of Elsevier Science.

Site-Specific Recombination

Alignment of sites for homologous recombination occurs via DNA - DNA (base-pairing) interactions. Another important class of recombination reactions is called **site-specific recombination**. It is directed by highly specific DNA - protein interactions, although a short stretch of DNA homology occurs at the actual site of cutting and resealing. Information about **site-specific recombination** is most advanced for the mechanism by which phages, such as λ , become integrated at specific sites on an infected bacterium's chromosome.

The λ chromosome integrates at a specific site on the *E. coli* chromosome, *attB*, which maps between genes involved in galactose utilization and biotin synthesis (the *gal* and *bio* markers), as illustrated in [Figure 25.17](#). Integration occurs at a specific site on the phage chromosome called *attP*.

Two proteins are required for this **site-specific recombination**. They are as follows:

1. **Phage integrase (Int)** - the product of the λ *int* gene; and
2. **Integration Host Factor (IHF)**--an *E. coli* protein.

Phage DNA must be supercoiled for the recombination to occur. Supercoiling, plus distortion created by Ihf binding to specific sites in *attP*, facilitates Int binding at adjacent sites. The nucleoprotein structure is called an intasome, which aligns with *attB* (also bound with Int). At the core of the λ and *E. coli* sequences is a 15-base region of complete homology ([Figure 25.31](#)). In each of these sequences, Int creates a staggered cut, with a 7-nucleotide overlap. The ends then exchange to form a Holliday junction and a DNA ligase activity of Int joins the ends covalently.

Upon integration, λ is dormant. Later, changes in the cell activate the virus which excises from the host genome by a reversal of the above steps to yield a circular virus. In this reaction, a protein called Xis is required in addition to Int and IHF.

See also: [Recombination](#), [Homologous Recombination](#)

INTERNET LINK [Recombination Tutorial](#)

Figure 25.35: Structures of class I, class II, and class III mobile genetic elements.



CLASS I

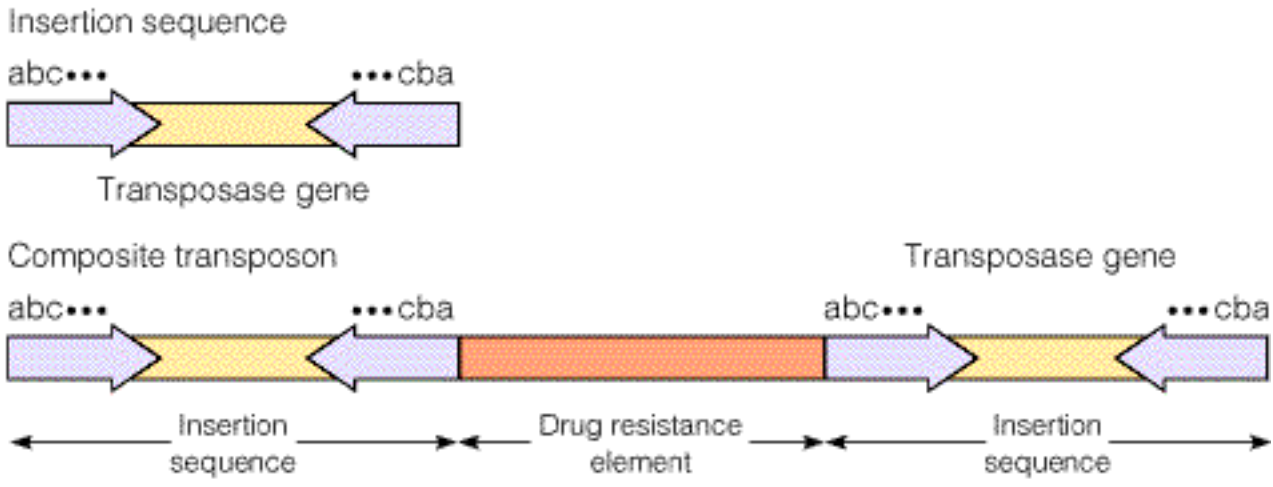

CLASS II

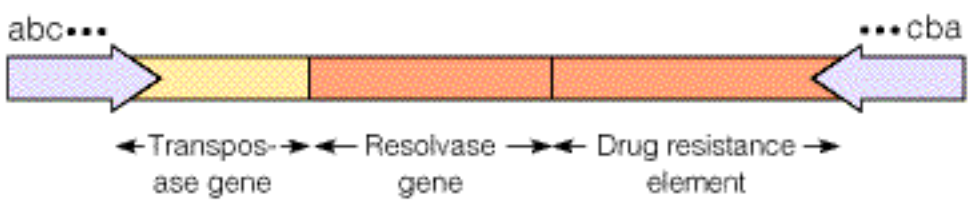

CLASS III

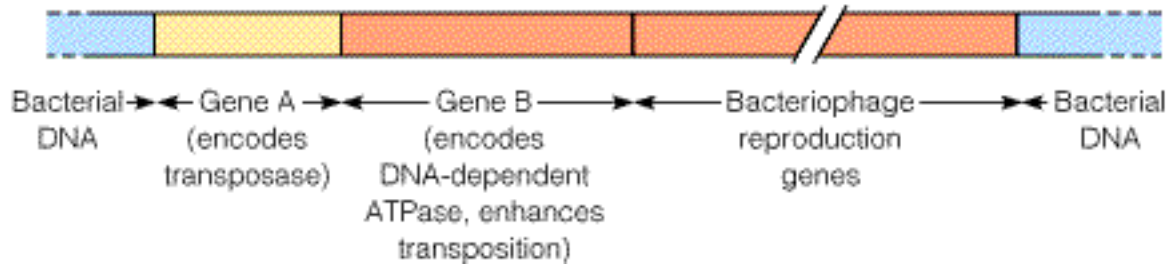

Class I Transposable Elements

Class I elements ([Figure 25.35](#)) encode a transposase but not a resolvase, and are of two types. The simplest is called an insertion sequence (IS), which consists simply of a gene for transposase, flanked by two short inverted repeat sequences of about 15 to 25 base pairs. A less simple structure, called a composite transposon, consists of a protein-encoding gene, such as a gene conferring antibiotic resistance, flanked by two insertion sequences, or IS-like elements. These elements may be in either identical or inverted orientations.

See also: [Transposable Genetic Elements Recombination](#), [Site-Specific Recombination](#), [Gene Rearrangements](#), [Table 25.4](#)

Table 25.4



Element	Size (bp)	Target DNA (bp)	Resistance Conferred
Insertion sequences			
IS1	768	9	None
IS2	1327	5	None
IS10-R	1329	9	None
Composite transposons			
Tn5	5700	9	Kanamycin
Tn10	9300	9	Tetracycline
Tn2571	23,000	9	Chloramphenicol, fusidic acid, streptomycin, sulfonamides, and mercury
Class II transposons			
Tn3	4957	5	Ampicillin
Class III transposons			
Phage Mu	38,000	5	None

Source: Excerpted from N. Kleckner, *Annu. Rev. Genet.* (1981) 15:354. © 1981 Annual Reviews, Inc.

Class II Transposable Elements



Class II transposons ([Figure 25.35](#)) contain only one set of short flanking direct repeat sequences. In addition to a protein-encoding gene (often conferring antibiotic resistance) and a transposase gene, the elements include a gene for resolvase.

See also: [Transposable Genetic Elements Recombination](#), [Site-Specific Recombination](#), [Gene Rearrangements](#), [Table 25.4](#)

Class III Transposable Elements

Class III elements ([Figure 25.35](#)) belong to a small group of bacteriophages, of which the best-known is phage Mu. This phage is known to insert its chromosome at random in the host chromosome by a transpositional mechanism and also to replicate its genome by a transpositional mechanism, similar to that of type II elements. One gene of this phage, A, encodes a transposase. Another gene, B, encodes a protein with DNA-dependent ATPase activity. Whereas class I and class II transposable elements synthesize transposase at such low levels that transposition occurs at frequencies of only 10^{-7} to 10^{-5} per generation, phage Mu integrates about 100 times per lytic infection. The B gene product is partially responsible for this far greater efficiency of transposition. Other genes encode structural and other proteins of the virus.

See also: [Transposable Genetic Elements Recombination](#), [Site-Specific Recombination](#), [Gene Rearrangements](#), [Table 25.4](#)

Figure 25.36: Model of how direct repeats are generated during the insertion of a transposon or an insertion sequence.

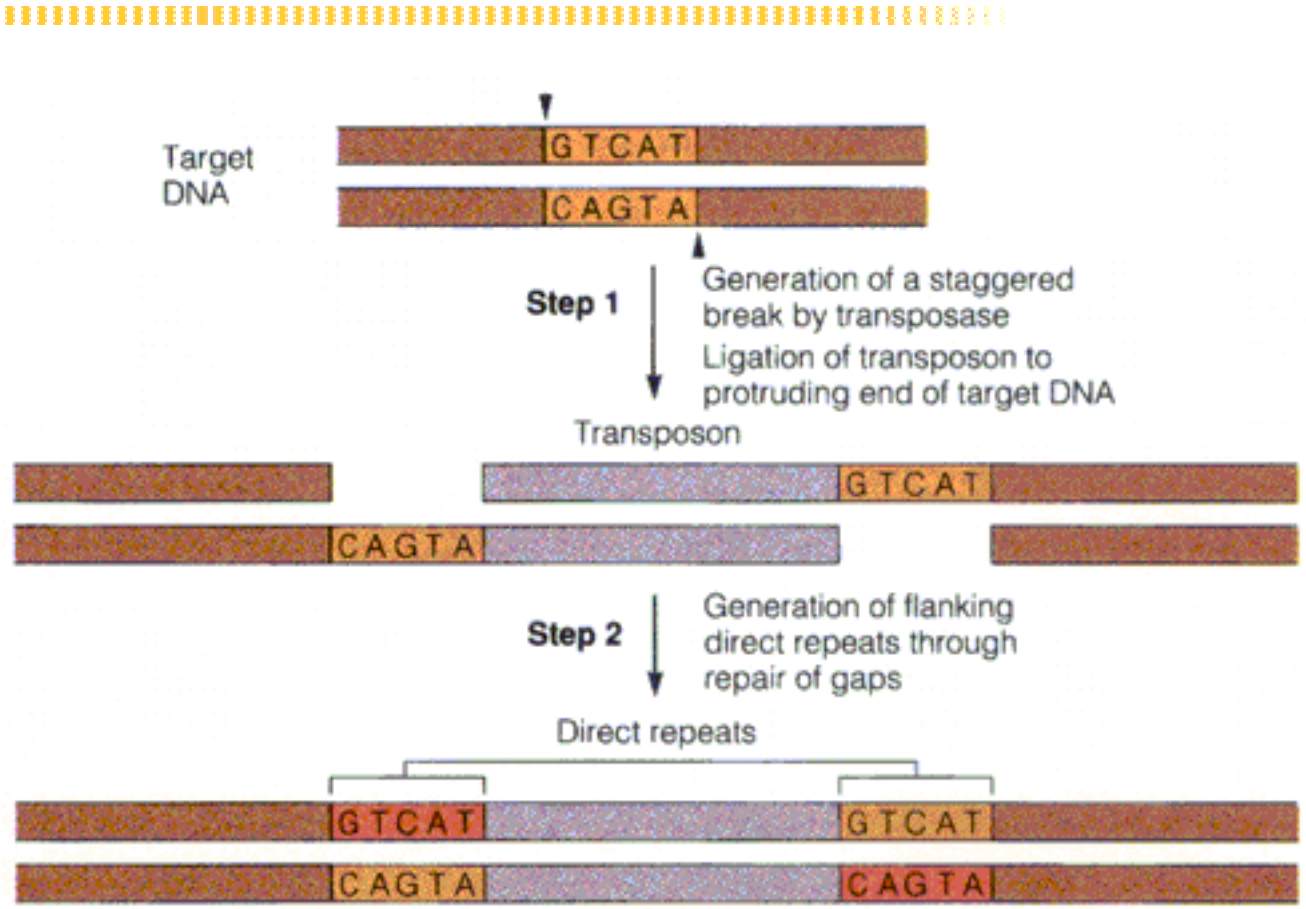
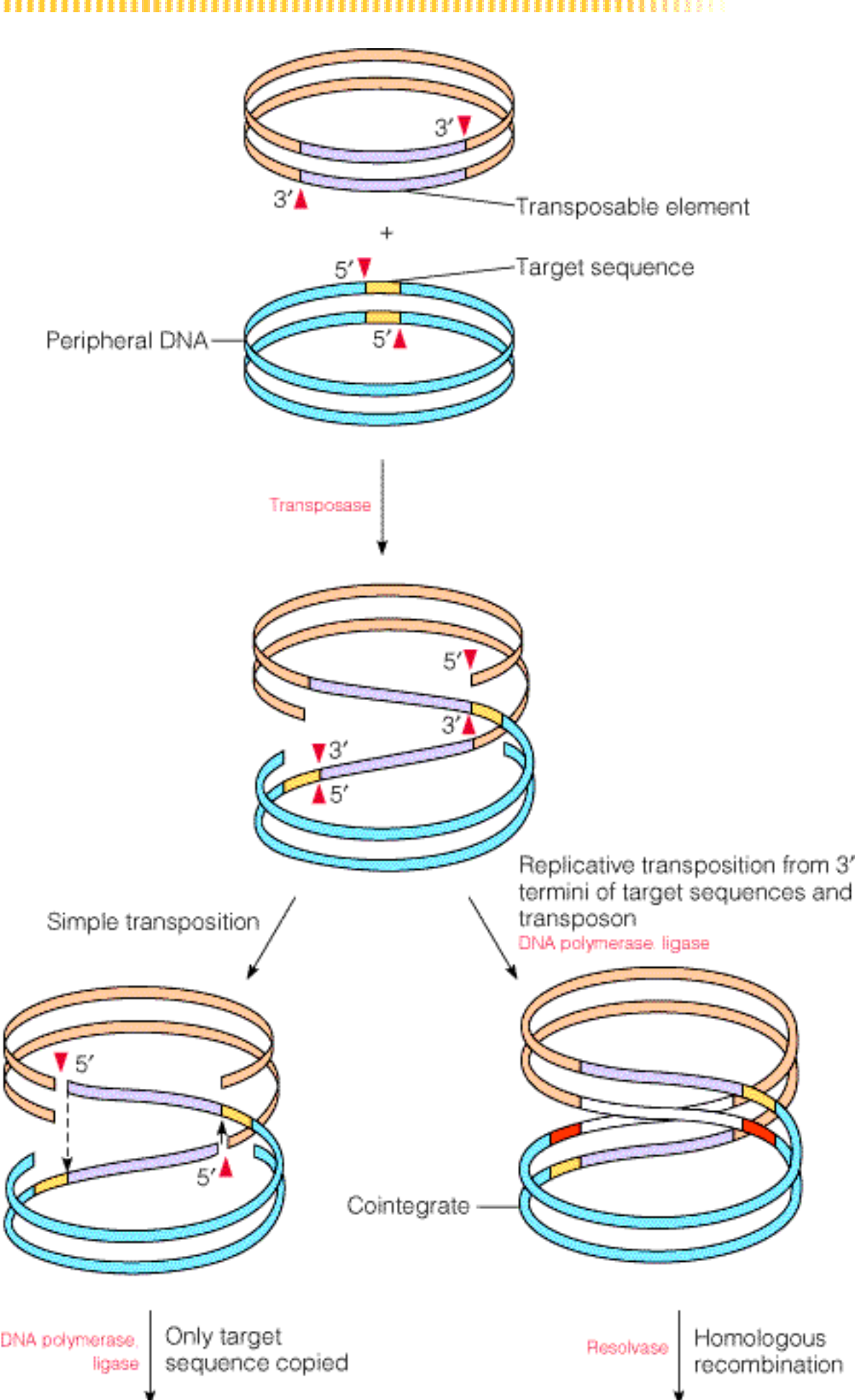
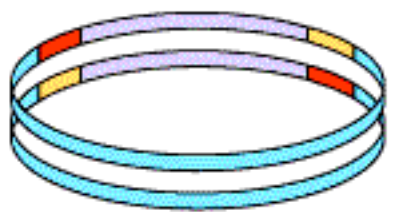

Figure 25.37: Models of simple transposition and replicative transposition.



DNA polymerase, ligase
Only target sequence copied



+

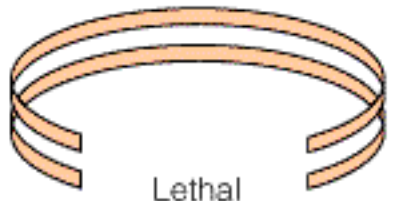

Resolvase
Homologous recombination

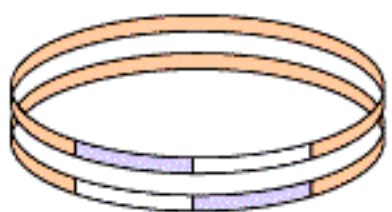

+

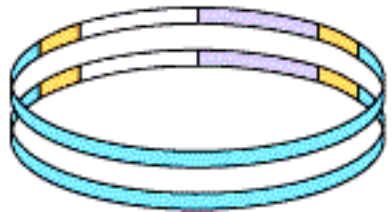

Evolution of Myoglobin / Hemoglobin Proteins

Protein Evolution - [Figure 5.14](#) compares the amino acid sequences of sperm whale myoglobin and human myoglobin. Out of the 153 **amino acids** in both myoglobins, there are only 25 differences, thus 25 amino acid changes have arisen since sperm whales and humans diverged from a common mammalian ancestor about 100 million years ago. For human and shark myoglobin, on the other hand, about 88 differences have arisen since their evolutionary lines diverged about 400 million years ago. The number of amino acid substitutions in two related proteins is roughly proportional to the evolutionary time that has elapsed since the proteins (and the species) had a common ancestor. Using this principle, and comparing the sequences of both **hemoglobins** and **myoglobins** one can construct a "family tree" of the globin proteins ([Figure 7.23](#)). The tree is complicated by the fact that higher eukaryotes, including humans, carry genes for both myoglobin and several different hemoglobin chains (see [here](#)).

Primitive Globin - Very primitive animals had only a myoglobin-like, single-chain ancestral globin for oxygen storage and were so small that they did not require a transport protein. Roughly 500 million years ago the ancestral myoglobin gene was duplicated. One copy became the ancestor of the myoglobin genes of all higher organisms. The other copy evolved into the gene for an oxygen transport protein and gave rise to the hemoglobins.

Most Primitive Hemoglobin - The most primitive animals to possess hemoglobin are the lampreys. Lamprey hemoglobin can form dimers but not tetramers and is only weakly cooperative. It represents a first step toward allosteric binding. Subsequently a second gene duplication must have occurred, giving rise to the ancestors of the present-day α and β hemoglobin chain families. This must have happened about 400 million years ago, at about the time of divergence of the sharks and bony fish. The evolutionary line of the bony fish led to the reptiles and eventually to the mammals, all carrying genes for both α and β globins and capable of forming tetrameric $\alpha_2\beta_2$ hemoglobins. Further gene duplications have occurred in the hemoglobin line, leading to the embryonic forms ζ and ϵ , the fetal form, γ , and the infant form δ ([Figure 7.22](#)).

Conserved Amino Acid Sequences - During the long evolution of the myoglobin/hemoglobin family of proteins, only a few amino acid residues have remained invariant ([Figure 7.11](#)). They include the histidines proximal and distal to the heme iron (F8 and E7- see [Figure 7.5b](#)) and Val FG5, which has been implicated in the hemoglobin deoxy/oxy conformation change. These may mark the truly essential positions in the molecule. Other regions highly conserved in hemoglobins are those near the $\alpha_1 - \beta_2$ and $\alpha_2 - \beta_1$ contacts. These parts of the molecule are most directly involved in the allosteric conformational change.

Backbone Structures - [Figure 7.24](#) shows the backbone structure of members of the myoglobin/hemoglobin family, ranging from insect to horse. It reveals that the secondary and tertiary structures of these proteins have remained surprisingly constant, despite the major changes in primary structure

(amino acid sequence) changes that have occurred over hundreds of millions of years. Survival of mutant proteins in the globin family has been restricted to those that maintain the basic "globin fold."

See also: [Globin Gene Expression in Development](#), [Mechanisms of Protein Mutation](#), [Hemoglobin Variants](#)

INTERNET LINK: [Globin Gene Server](#)

Figure 7.23: Evolution of the globin genes.

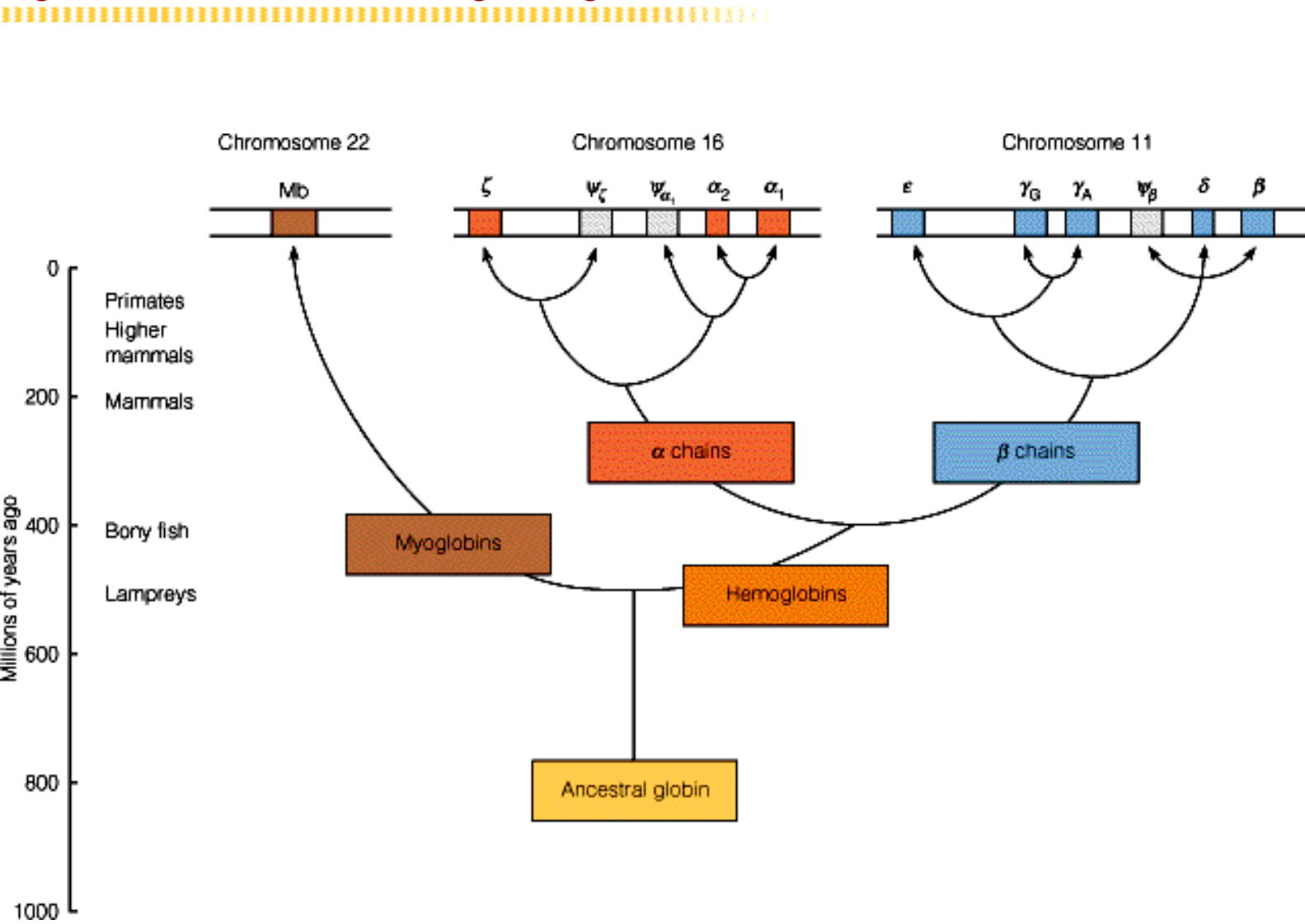

Globin Gene Expression in Development

Developmental Expression of Globins - Multiple **globin** genes are expressed at different times in human development ([Figure 7.22](#)). In the early embryo, the hemoglobin genes expressed are those for the embryonic chains, ζ and ϵ . As the fetus develops, these chains are replaced by α and γ chains, and finally, at about the time of birth, the γ chains are replaced by β chains. In addition, after birth a small amount of a δ chain is produced. By age six months, the infant will have almost all $\alpha_2\beta_2$ (adult) hemoglobin. These developmental types of hemoglobin chain are slightly different, and each is coded for by a separate gene in the human genome.

See also: [Evolution of Myoglobin/Hemoglobin Proteins](#)

INTERNET LINKS:

1. [Human Globin Genes](#)
 2. [Globin Gene Server](#)
-

Figure 7.22: Expression of human globin genes at different stages of development.

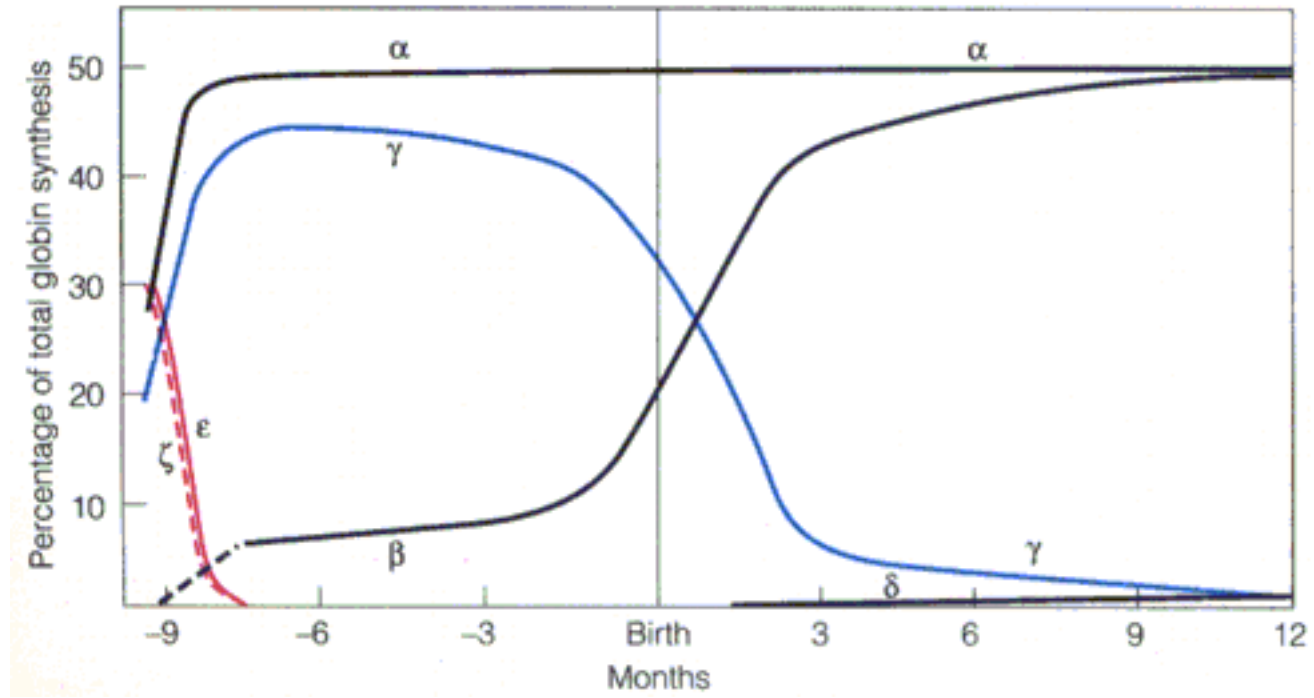

W. G. Wood, Br. Med. Bull. (1976) 32:282-287.

Figure 7.5: The geometry of iron coordination in oxymyoglobin.

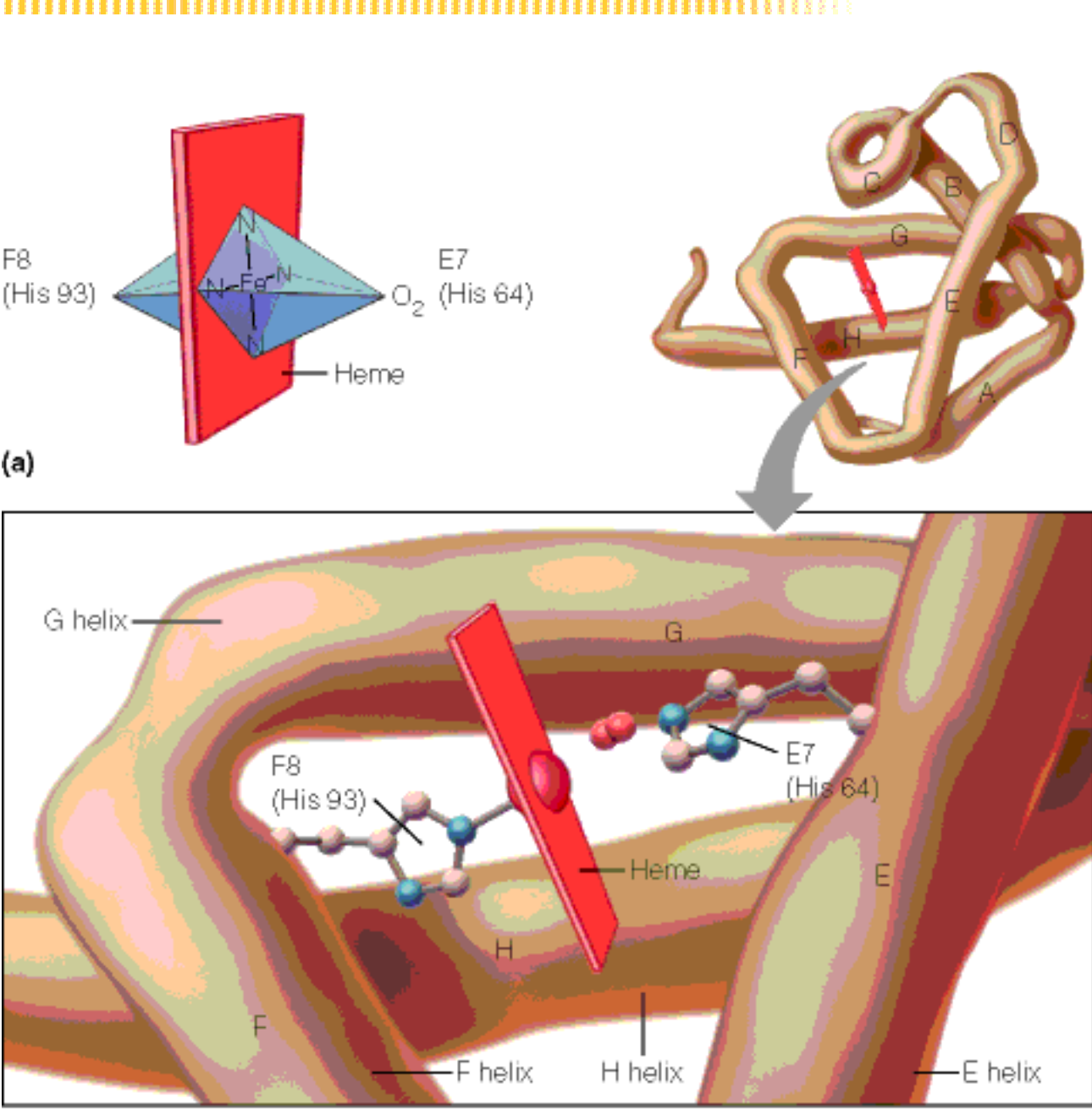
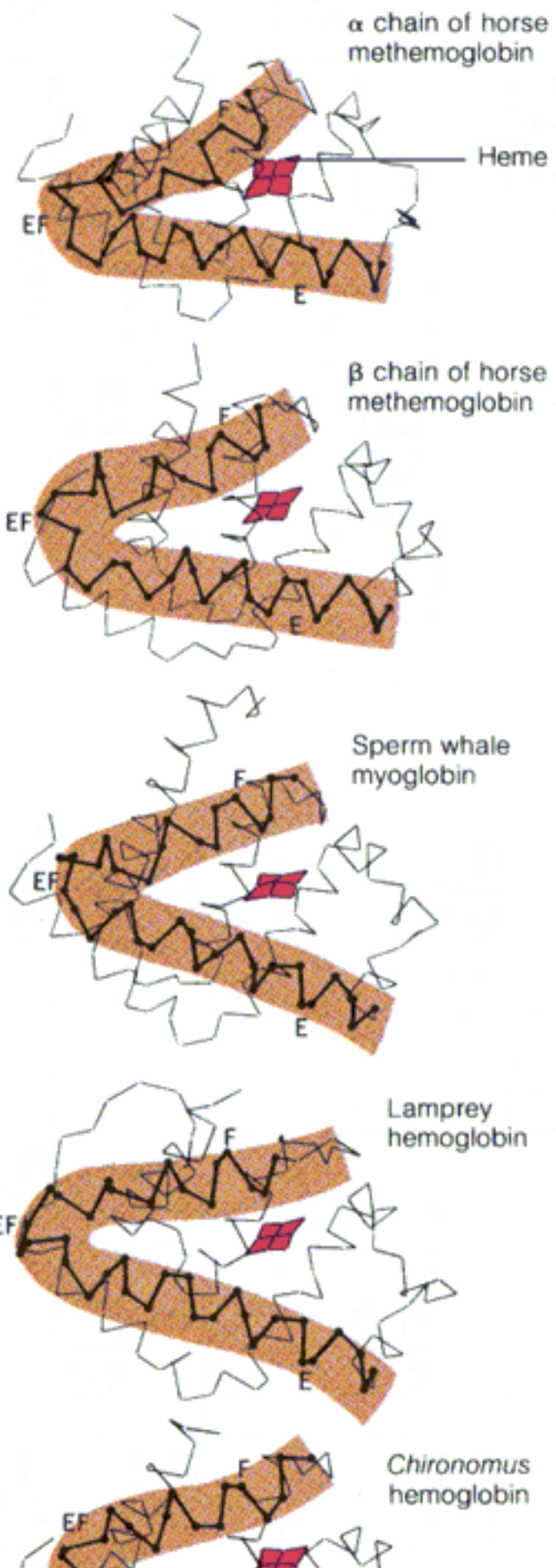
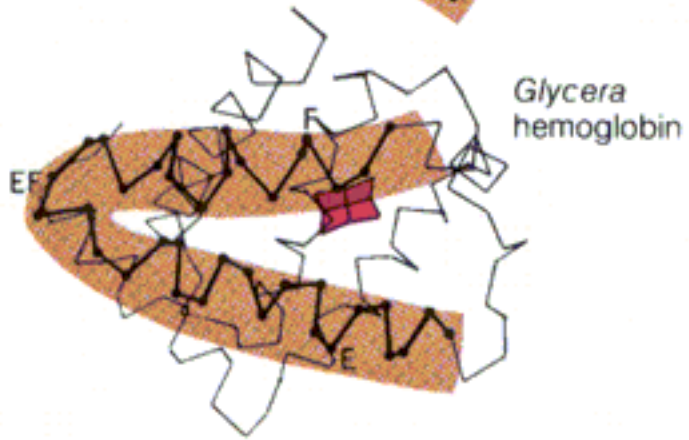
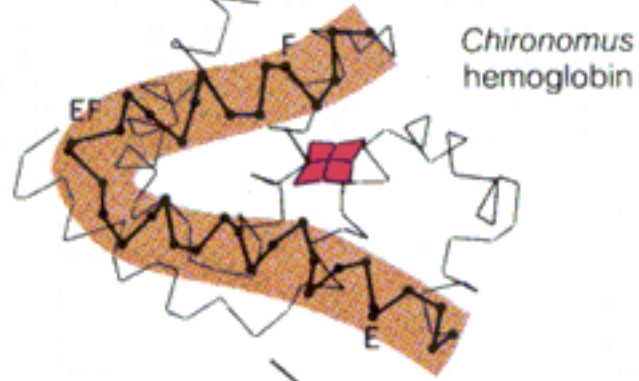

Figure 7.24: Evolutionary conservation of the globin folding pattern.





© Irving Geis.

Hemoglobin Variants



Ongoing Evolution - Evidence for the ongoing evolution of hemoglobin genes can be seen in the existence of numerous hemoglobin variants. Mutation positions of mutant hemoglobins in the human population are shown in [Figure 7.25](#). Most proteins in existing plants and animals probably show comparable diversity.

Each of the mutant forms of [hemoglobin](#) exists in only a small fraction of the total human population. Many of the mutant forms are deleterious. Others appear to be harmless, and are often referred to as neutral mutations. A very few may have advantages. Inheritance of globin genes occurs as a result of standard genetic processes (see [here](#) for a review of genetics).

Pathological Effects - Deleterious mutations ([Table 7.2](#)) are mostly clustered about the heme pockets and in the vicinity of the α - β contact region that is so important in the allosteric transition ([Figure 7.25](#)).

Sickle-Cell Hemoglobin - **Sickle-cell hemoglobin** has gained its name because it causes red blood cells to adopt an elongated, sickle shape at low oxygen concentrations, due to the tendency of the mutant hemoglobin, in its deoxygenated state, to aggregate into long, rodlike structures. The elongated cells tend to block capillaries, causing inflammation and considerable pain. Even more serious is that the sickled cells are fragile. Their breakdown leads to an anemia that leaves the victim susceptible to infections and diseases. Individuals who are homozygous for the sickle-cell mutation often do not survive into adulthood, and those who do are seriously debilitated.

Sickling Mechanism - Remarkably, sickling stems from an apparently innocuous mutation in a part of the molecule far from the critical regions of the heme pockets and the α/β contact regions ([Figure 7.21a](#)). The [Glutamate](#) residue normally found at position 6 in β chains is replaced by a [valine](#) (see [Figure 7.21a](#)). Valine is small (and hydrophobic) and can fit into a pocket at the EF corner of a β chain in another hemoglobin molecule. Thus adjacent hemoglobin molecules can fit together into a long, rodlike helical fiber. Sickling occurs with deoxyhemoglobin, but not with oxyhemoglobin, because the rearrangement of subunits in the oxy form makes the EF pocket inaccessible.

Sickle Cell Advantage - Individuals heterozygous for sickle-cell hemoglobin have a higher resistance to malaria than those who do not carry the sickle-cell mutation. The malarial parasite spends a portion of its life cycle in human red cells, and the increased fragility of the sickled cells, even in heterozygous individuals, tends to interrupt this cycle. Heterozygous individuals have a higher survival rate-and therefore a better chance of passing on their genes-in malaria-infested regions. However, the high incidence of these genes in the population leads to the birth of many people who are homozygous for the mutant trait.

See also: [Evolution of Myoglobin/Hemoglobin Proteins](#), [Thalassemias](#), [Hemoglobin](#)

INTERNET LINKS:

1. [Thalassemia Overview](#)
 2. [Sickle Cell Disease](#)
 3. [Hemoglobin Overview](#)
 4. [Globin Gene Server](#)
-

Figure 7.25: Distribution of mutations in human hemoglobins.

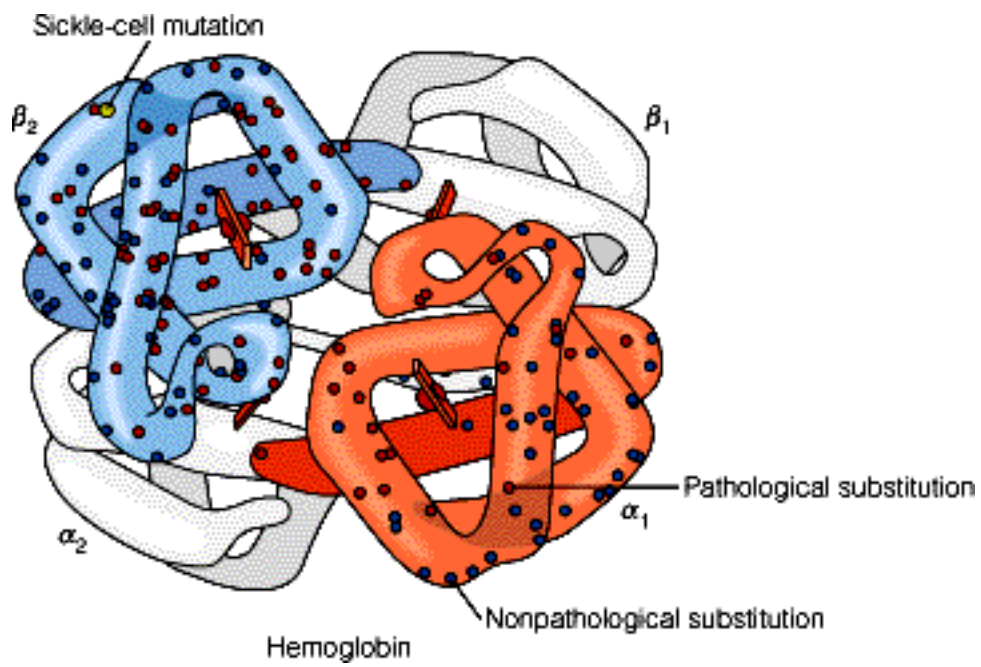

© Irving Geis.

Genetics Review

Human cells are diploid, which means they carry two copies of each chromosome. Thus, they carry two copies of each gene, one on each of the paired chromosomes. For a gene such as the adult β hemoglobin gene, which can exist in two forms—the "normal" type, β , and a variant (mutant) type, β^* , an individual can have three possible combinations of these genes in the paired chromosomes:

- A. $\beta + \beta$: homozygous (same genes) in the normal type
- B. $\beta + \beta^*$: heterozygous (mixed genes)
- C. $\beta^* + \beta^*$: homozygous in the variant type

Individual A will produce only normal β hemoglobin chains. Individual C, will produce only variant hemoglobin chains. Individual B, with genes for both types, will produce both. If the mutation is deleterious, A will be unaffected, but C will be in serious trouble. B, on the other hand, may do fairly well, because he or she will make normal protein chains along with the variant ones.

When two individuals produce offspring, each parent donates to a child one copy of the β hemoglobin gene, the selection of which will be random. If both parents are heterozygous for the gene ([Figure 7.26](#)), the child has one chance in four of being homozygous normal, one in four of being homozygous for the variant gene, and two in four of being heterozygous. Because most variant hemoglobin genes are rare in the human population, only occasionally do we find an individual homozygous for the variant type.

Return to: [Hemoglobin Variants](#)

Figure 7.26: Inheritance of normal and variant proteins in a heterozygous cross.

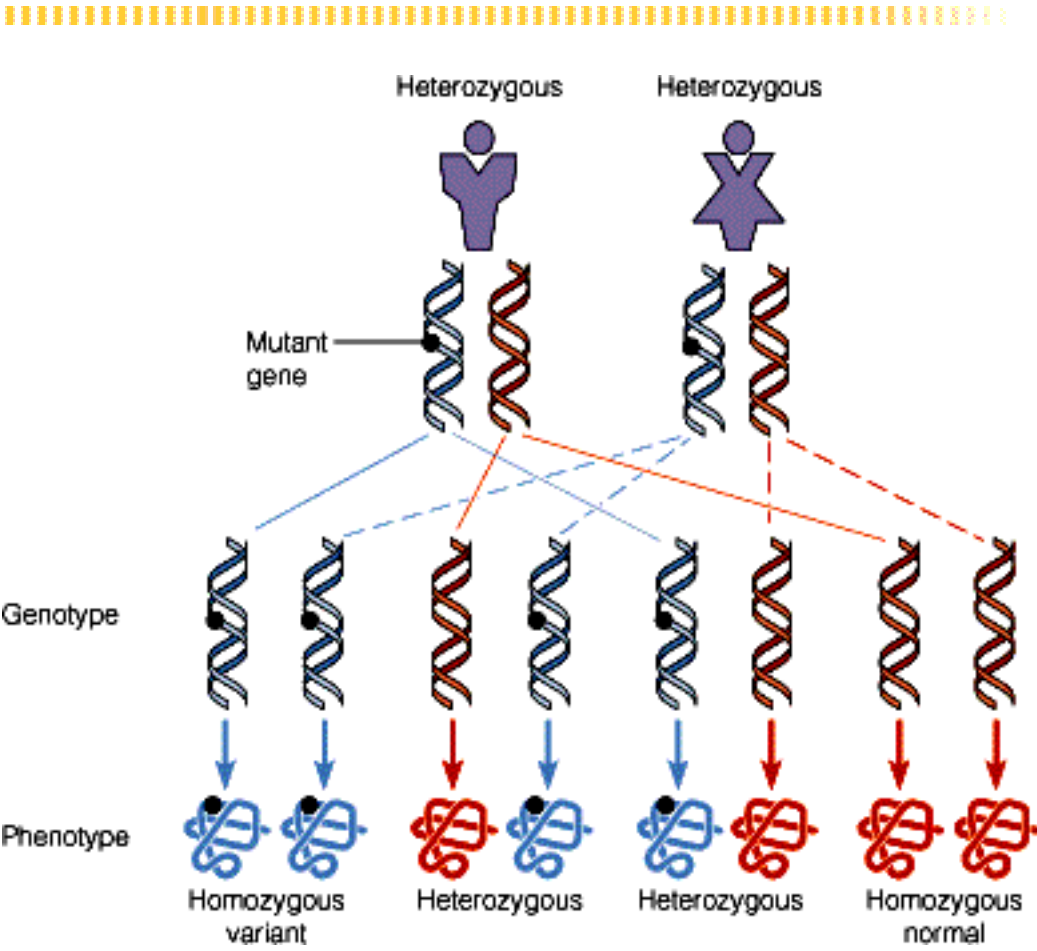

Table 7.2



Effect	Residue Changed	Change	Name	Consequences of Mutation	Explanation
Sickling	$\beta 6$ (A3)	Glu \rightarrow Val	S	Sickling	Val fits into EF pocket in chain of another hemoglobin molecule.
	$\beta 6$ (A3)	Glu \rightarrow Ala	G Makassar	Not significant	Ala probably does not fit the pocket as well.
	$\beta 121$ (GH4)	Glu \rightarrow Lys	O Arab, Egypt	Enhances sickling in S/O heterozygote	$\beta 121$ lies close to residue $\beta 6$; Lys increases interaction between molecules.
Change in O ₂ affinity	$\alpha 87$ (F8)	His \rightarrow Tyr	M Iwate	Forms methemoglobin, decreased O ₂ affinity	The His normally ligated to Fe has been replaced by Tyr.
	$\alpha 141$ (HC3)	Arg \rightarrow His	Suresnes	Increases O ₂ affinity by favoring R state	Replacement eliminates bond between Arg 141 and Asn 126 in deoxy state.
	$\beta 74$ (E18)	Gly \rightarrow Asp	Shepherds Bush	Increases O ₂ affinity by decrease in BPG binding	The negative charge at this point decreases BPG binding.
	$\beta 146$ (HC3)	His \rightarrow Asp	Hiroshima	Increases O ₂ affinity, reduced Bohr effect	Disrupts salt bridge in deoxy state and removes a His that binds a Bohr-effect proton.
	$\beta 92$ (F8)	His \rightarrow Gln	St. Etienne	Loss of heme	The normal bond from F8 to Fe is lost, and the polar glutamine tends to open the heme pocket.
Heme loss	$\beta 42$ (CD1)	Phe \rightarrow Ser	Hammersmith	Unstable, loses heme	Replacement of hydrophobic Phe with Ser attracts water into heme pocket.
Dissociation of tetramer	$\alpha 95$ (G2)	Pro \rightarrow Arg	St. Lukes	Dissociation	Chain geometry is altered in subunit contact region.
	$\alpha 136$ (H19)	Leu \rightarrow Pro	Bibba	Dissociation	Pro interrupts helix H.

Thalassemias

Variant Hemoglobins - **Hemoglobin** variants (see [here](#)) arise from **missense mutations**. By contrast, if one or more of the chains of hemoglobin are produced in insufficient amounts, a pathological condition called **thalassemia** arises. **Thalassemia** can arise in the following ways:

1. One or more of the genes coding for hemoglobin chains is deleted.
2. One or more of the genes coding for hemoglobin chains may have undergone a nonsense mutation that produces a shortened chain or a frameshift mutation that produces a nonfunctional chain (see [Figure 7.21b and c](#)).
3. A mutation may have occurred outside the coding regions, leading to a block in transcription or to improper processing of the pre-mRNA, so the protein is not produced or is not functional.

In case 1 or 2, the gene produces no functional protein. In case 3, limited transcription and translation of the correct polypeptide sequence may occur.

Classes - Two major classes of **thalassemias** involving loss or malfunction of genes for the adult β and α chains:

β -Thalassemia - In individuals where the β globin gene is lost or cannot be expressed, no β chains are made. These individuals are dependent upon continued production of the fetal γ chains to make a functional hemoglobin, $\alpha_2\gamma_2$. Such individuals may produce γ chains well into childhood, but they usually die before reaching maturity.

Much less serious is the heterozygous state, in which one β gene is still functioning. Milder **thalassemias** (called β_1) are known in which transcription or processing of the β genes are partially inhibited, reducing the amount of β globin synthesized.

α -Thalassemias - **Thalassemias** involving the α chain are more complicated. Two copies of the gene (α_1 and α_2) are next to each other on human chromosome 16. Their sequences differ by only one amino acid, and one can replace the other in the assembled hemoglobin tetramer. An individual can have 4, 3, 2, 1, or 0 copies of an α gene. Only if three or more genes are nonfunctional are serious effects observed. Individuals with only one α gene are anemic, because their total hemoglobin production is low. The low level of α hemoglobin is partially compensated for by formation of β_4 tetramers (hemoglobin H) and γ_4 tetramers (hemoglobin Bart's). These tetramers can bind and carry oxygen, but they do not exhibit the allosteric transition (they remain always in the R state), nor do they

exhibit a **Bohr effect**. As a result, the unloading of oxygen to tissues is inefficient. If all four α gene copies are missing, individuals with this condition are inevitably stillborn. They can form only γ_4 hemoglobin and, because the supply of γ chains falls near birth (**Figure 7.22**), not enough hemoglobin is available to support the near-term fetus.

Because there are two copies of the α gene but only one of the β gene, the most deleterious mutations in mammalian hemoglobins usually occur in the β chains. This phenomenon may suggest a functional role for gene duplication. That is, if two or more copies of a gene are present, the species is somewhat protected from the harmful effects of mutations.

See also: [Hemoglobin Variants](#), [Globin Gene Expression in Development](#), [Evolution of Myoglobin/Hemoglobin Proteins](#), [Mechanisms of Protein Mutation](#), [Hemoglobin](#)

INTERNET LINKS:

1. [Thalassemia Overview](#)
 2. [Sickle Cell Disease](#)
 3. [Hemoglobin Overview](#)
 4. [Globin Gene Server](#)
-

Oxygen Binding by Hemoglobin



Parameters of Oxygen Binding - To be useful, an oxygen transport protein must accept oxygen efficiently at the partial pressure found in lungs or gills (approximately 100 mm Hg) and then deliver an appreciable fraction of it at the partial pressure found in tissues (about 30 mm Hg). Thus, an ideal oxygen transport protein would be nearly saturated at 100 mm Hg and unsaturated at about 20 - 40 mm Hg. In that way, each transport protein molecule could deliver a significant fraction of its oxygen load. If the transport protein had a hyperbolic binding curve like that of [myoglobin](#), it could be efficient either in uptake or in delivery of oxygen ([Figure 7.8a and b](#)), but not both.

Cooperativity of Binding/Release - [Hemoglobin](#), which has a sigmoidal binding curve like that shown in [Figure 7.8c/d](#), transports oxygen very efficiently, allowing nearly full oxygen saturation of the protein in the lungs or gills, and delivers oxygen very efficiently, allowing maximal release of oxygen in the capillaries. As more oxygen is bound, hemoglobin's affinity for oxygen increases. Such behavior indicates that a **cooperative** interaction exists among oxygen binding sites in the protein molecule. Thus, filling the first oxygen binding site in hemoglobin increases the affinity of the remaining sites for oxygen. Conversely, losing an oxygen from hemoglobin makes it easier for the protein to lose its remaining oxygen molecules. This can happen only if some kind of communication takes place among binding sites. A single-site protein, such as myoglobin, cannot accomplish this sort of communication, for one myoglobin molecule is completely ignorant (independent) of the state of another. It is for this reason that all oxygen transporting proteins are multisubunit structures (such as hemoglobin), whereas oxygen storage proteins are single-subunit structures (such as myoglobins).

Evolution of Hemoglobin - In the evolutionary line that led to the vertebrates, the protein used for oxygen transport (hemoglobin) has evolved from the more primitive, single subunit myoglobin into the kind of tetrameric structure shown in [Figure 7.3](#). Each of the subunits has primary, secondary, and tertiary structures like those of myoglobin, but the amino acid side chains in hemoglobin also provide interactions-salt bridges, hydrogen bonds, and hydrophobic interactions - to stabilize hemoglobin's quaternary (multisubunit) structure.

Differences Between Myoglobin and Hemoglobin - Each hemoglobin molecule can bind four oxygens (versus one for myoglobin), in four sites similar to those of myoglobin. Functionally, hemoglobin differs from myoglobin because the oxygenation state (filled or empty) of one site of the multisubunit hemoglobin can be communicated to another site, resulting in cooperative binding and release of oxygen.

Allosteric Effects - The cooperative binding of oxygen by hemoglobin is one example of what is referred to as **allosteric effects**. In **allosteric** binding, the uptake of one ligand by a protein influences the affinities of remaining unfilled binding sites. The ligands may be of the same kind, as in oxygen binding to hemoglobin, or they may be different, as in the way binding of [2,3-bisphosphoglycerate](#) to hemoglobin affects the protein's affinity for oxygen (see [here](#)). **Allostery** is also an important mechanism for regulating the activity of enzymes. For example, both the enzymatic activity and the

substrate preferences of the nucleotide metabolism enzyme, [ribonucleotide reductase](#), are controlled by small effector molecules, such as [ATP](#) (see [here](#)). In this case, **allostery** allows one kind of small molecule to regulate the action of a protein on another kind of molecule. The ability of multisubunit proteins to be regulated **allosterically** may be one of the reasons these proteins are so common.

See also: [Hill Plots and Cooperativity](#), [Oxygen Binding by Myoglobin](#), [Hemoglobin Allostery](#), [Evolution of Myoglobin/Hemoglobin Proteins](#), [Regulation of Ribonucleotide Reductase](#) (from Chapter 22), [Bisphosphoglycerate and Hemoglobin](#)

Oxygen Binding by Myoglobin

Physiological Usefulness of Myoglobin - [Myoglobin](#) in tissues (especially in muscle) accepts oxygen from hemoglobin in the circulating arterial blood, then delivers the oxygen to the [mitochondria](#) when oxygen needs are sufficiently great ([Figure 7.1](#)).

From Henry's law, the concentration of any gas dissolved in a fluid is proportional to the partial pressure of that gas above the fluid. For O₂, this is expressed as PO₂.

Measuring Myoglobin Binding of Oxygen - Spectrophotometry can measure the fraction of myoglobin molecules that are oxygenated. The O₂ binding curve of myoglobin in solution at neutral pH, shown in [Figure 7.6](#), illustrates how the fraction of the myoglobin sites that have oxygen bound to them (θ) depends on the concentration (partial pressure) of free oxygen.

Derivation of the Hyperbolic Shape of the Myoglobin Binding Curve - [here](#).

Useful Properties of Myoglobin's Binding of Oxygen - The P₅₀ (oxygen partial pressure required for half saturation) for myoglobin is very low, signifying that myoglobin has a high affinity for oxygen-an important characteristic for a protein that must extract oxygen from the small amounts present in blood. At the oxygen concentration existing in the capillaries, the myoglobin in adjacent tissues is nearly saturated. When cells are metabolically active, their internal PO₂ falls to levels where myoglobin will lose (deliver) its oxygen.

Binding and Release of Oxygen - The affinity with which myoglobin binds oxygen can be expressed with an affinity constant, K. K is an equilibrium constant that is the ratio of two rate constants.

$$K = k_1/k_{-1},$$

where k₁ is the rate constant for the binding reaction and k₋₁ is the rate constant for the release reaction.

Computer simulations of the behavior of oxymyoglobin suggest that the rate-limiting process in oxygen release is the opening of a pathway for the O₂ molecule to escape from the heme pocket. Oxygen may spend time "rattling in its cage" - and perhaps being recaptured - before the tertiary structure of the myoglobin shifts enough to let it escape ([Figure 7.7](#)). This process is an explicit example of a principle set forth elsewhere ([here](#)) - the dynamic internal motions of globular protein molecules play important roles in regulating the processes proteins mediate. The flexibility of myoglobin may thus determine how strongly myoglobin binds oxygen.

See also: [Oxygen Binding by Heme Proteins](#), [Oxygen Binding by Hemoglobin](#), [Myoglobin](#)

Figure 7.6: Oxygen binding curve for myoglobin. Oxygen binding curve for myoglobin.

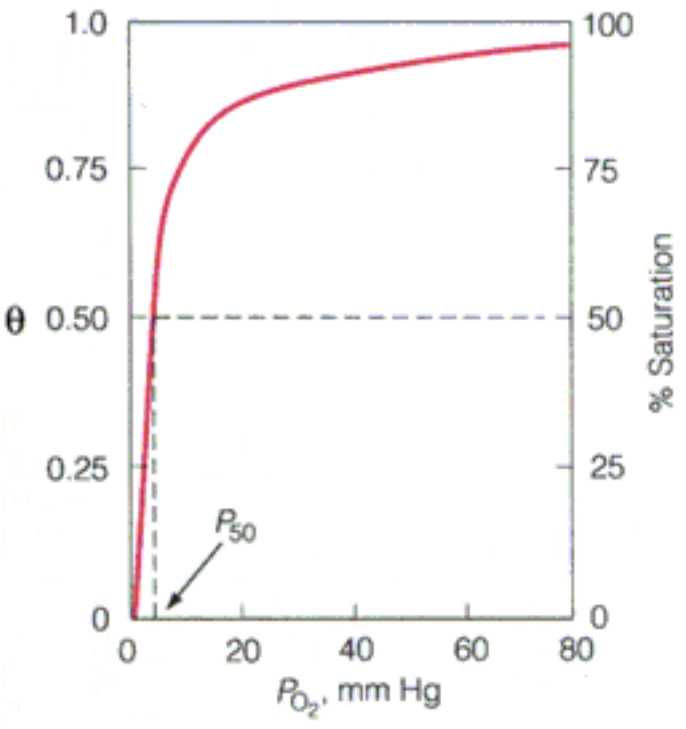

Derivation of the Hyperbolic Oxygen Binding Curve of Myoglobin

The binding equilibrium is described by the following equation

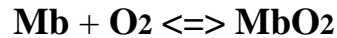

where Mb is nonoxygenated myoglobin and MbO₂ is oxygenated myoglobin. As a result,

$$K = \frac{[\text{MbO}_2]}{[\text{Mb}][\text{O}_2]} \quad (7.1)$$

where the equilibrium constant K is called an association constant or affinity constant. The quantities in brackets denote molar concentrations of oxygenated myoglobin [MbO₂], nonoxygenated myoglobin [Mb], and free oxygen [O₂]. The fraction of myoglobin sites occupied is defined as follows:

$$\theta = \frac{\text{sites occupied}}{\text{total available sites}} \quad (7.2)$$

Each myoglobin molecule has only one site, so the total number of available sites is proportional to the total concentration of myoglobin, [MbO₂] + [Mb]. Therefore,

$$\theta = \frac{[\text{MbO}_2]}{[\text{Mb}] + [\text{MbO}_2]} = \frac{K[\text{Mb}][\text{O}_2]}{[\text{Mb}] + K[\text{Mb}][\text{O}_2]} \quad (7.3)$$

where we have used [MbO₂] = K[Mb][O₂] from equation (7.1) to obtain the expression on the right. The concentration of unliganded myoglobin, [Mb], can be factored out of the numerator and denominator to give

$$\theta = \frac{K[\text{O}_2]}{1 + K[\text{O}_2]} = \frac{[\text{O}_2]}{1/K + [\text{O}_2]} \quad (7.4)$$

or

$$\theta = \frac{[\text{O}_2]}{[\text{O}_2]_{1/2} + [\text{O}_2]} \quad (7.5)$$

where we have made use of the fact that $1/K = [\text{O}_2]_{1/2}$, the oxygen concentration when half of the myoglobin molecules have oxygen bound to them. It is easy to check this relationship by setting $\theta = 1/2$ in equation (7.4). Because oxygen concentration is proportional to oxygen partial pressure, equation (7.5) can equally well be written as

$$\theta = \frac{P_{O_2}}{P_{50} + P_{O_2}} \quad (7.6)$$

where P_{50} is the oxygen partial pressure for half-saturation. Equation 7.6 describes the hyperbolic oxygen binding curve of myoglobin in [Figure 7.6](#).

Return to: [Oxygen Binding by Myoglobin](#)

Figure 7.7: Dynamics of oxygen release by myoglobin.

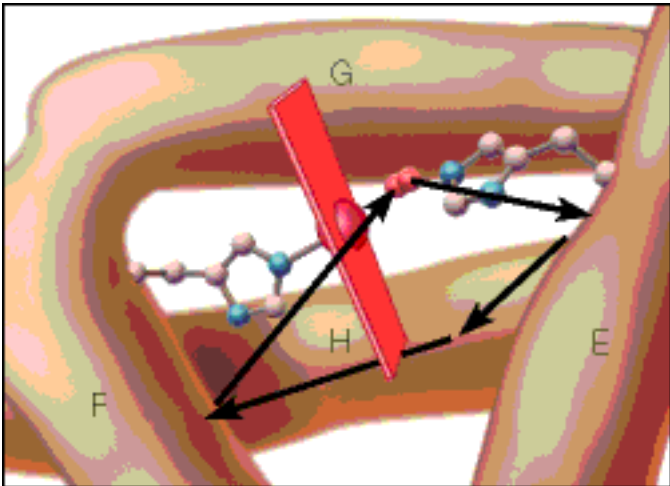

(a)

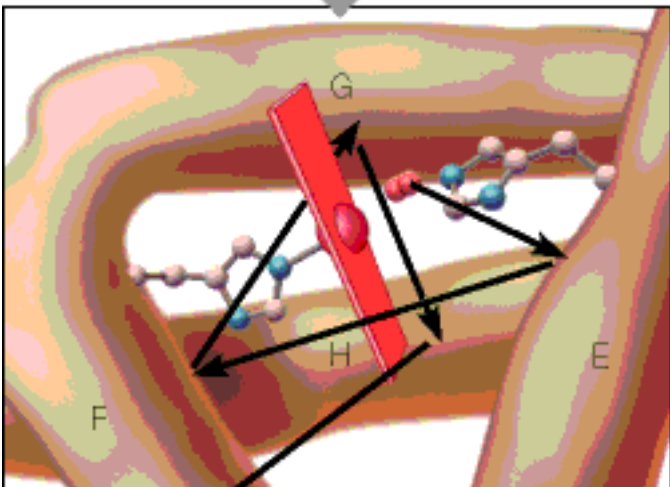

(b)



Motions Within Globular Protein Molecules

Much evidence indicates that **motions** are continually occurring within folded protein molecules. **Protein motions** can be roughly grouped into several classes, as shown in [Table 6.5](#).

Class 1 **motions** occur even within protein molecules in crystals and account, at least in part, for the limits of resolution obtainable in x-ray diffraction studies.

The larger, slower **motions** in classes 2 and 3 are more likely to occur in solution. Some of these, like the opening and closing of clefts in molecules, are thought to be involved in the catalytic functions of enzymes.

How long it takes for a protein to bind or release a small molecule may depend on the time required for the protein to open or close a cleft. Similarly, the protein "gates" that pass molecules and ions through membranes rapidly change from open to closed states. The dynamic behavior of proteins is at least as important in their function as the static details of their structure.

See also: [Globular Proteins](#), [Oxygen Binding by Myoglobin](#) (from Chapter 7)

INTERNET LINK: [Database of Macromolecular Movements](#)

Table 6.5



Class	Type of Motion	Approximate Range	
		Amplitude (nm)	Time (s)
1	Vibrations and oscillations of individual atoms and groups	0.2	10^{-15} – 10^{-12}
2	Concerted motions of structural elements, like α helices and groups of residues	0.2–1	10^{-12} – 10^{-8}
3	Motions of whole domains; opening and closing of clefts	1–10	$\geq 10^{-8}$

T Cells and the Cellular Response

Different Immune Responses - The humoral immune response is based on precipitation, but the **cellular response** involves a quite different mechanism for killing foreign cells. The **cellular response** plays a major role in tissue rejection and in destroying virus-infected cells. It may also destroy potential cancer cells before they have a chance to propagate. Although the mechanisms of the humoral and cellular processes are quite different, similar immunoglobulin molecules are involved in both cases ([Figure 7.35](#)).

Cytotoxic T Cells - The major participants in the cellular immune response are cytotoxic T cells, also referred to as killer T cells, which carry on their surfaces receptor molecules (T cell receptors) that are similar to the Fab fragments of antibody molecules. T cell receptors have a wide range of binding specificities, mostly directed toward short oligopeptide sequences. Oligopeptide sequences on foreign cells are bound by the major histocompatibility complex of T cells (MHC proteins; see [Figure 7.35](#)). When a killer T cell identifies (via its receptor) an appropriate antigen carried on the surface of another cell by an MHC protein, it releases a protein called perforin which forms pores in the plasma membrane of the cell being attacked, allowing critical ions to diffuse out and thereby killing the cell.

Common Structures - Both the antibodies of the humoral response and the molecules involved in the cellular response contain elements of common structure. The similarity is even greater than [Figure 7.35](#) suggests. The domains in these molecules are built on a common motif, called the immunoglobulin fold, in which two antiparallel β sheets lie face to face ([Figure 7.36](#)). This structure probably represents the primitive structural element in the evolution of the immune response. The immunoglobulin fold is also found in a number of other proteins.

See also: [AIDS and the Immune Response](#), [The Immune Response](#)

Figure 7.35: Comparison of proteins of the humoral and cellular immune responses.

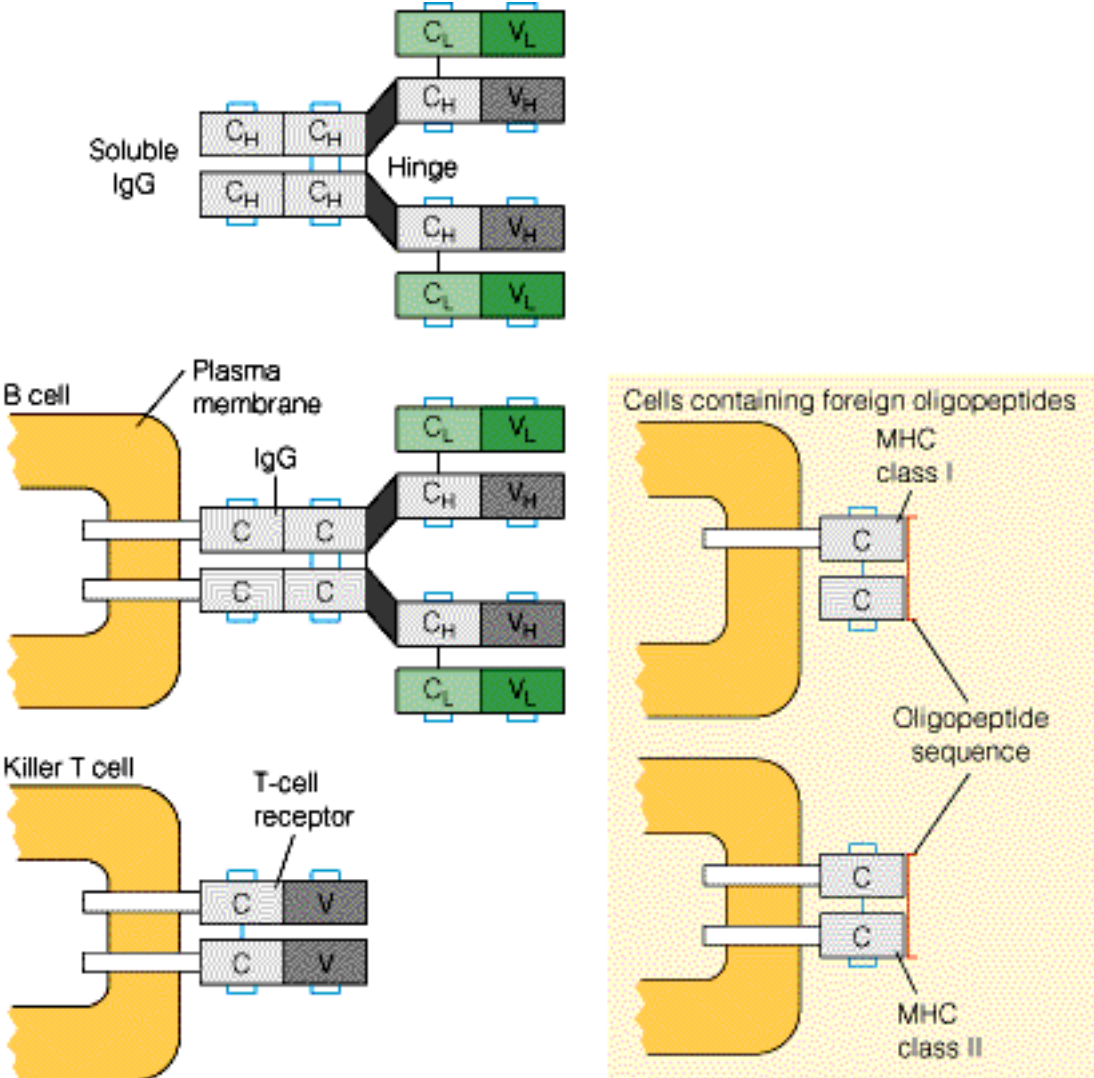
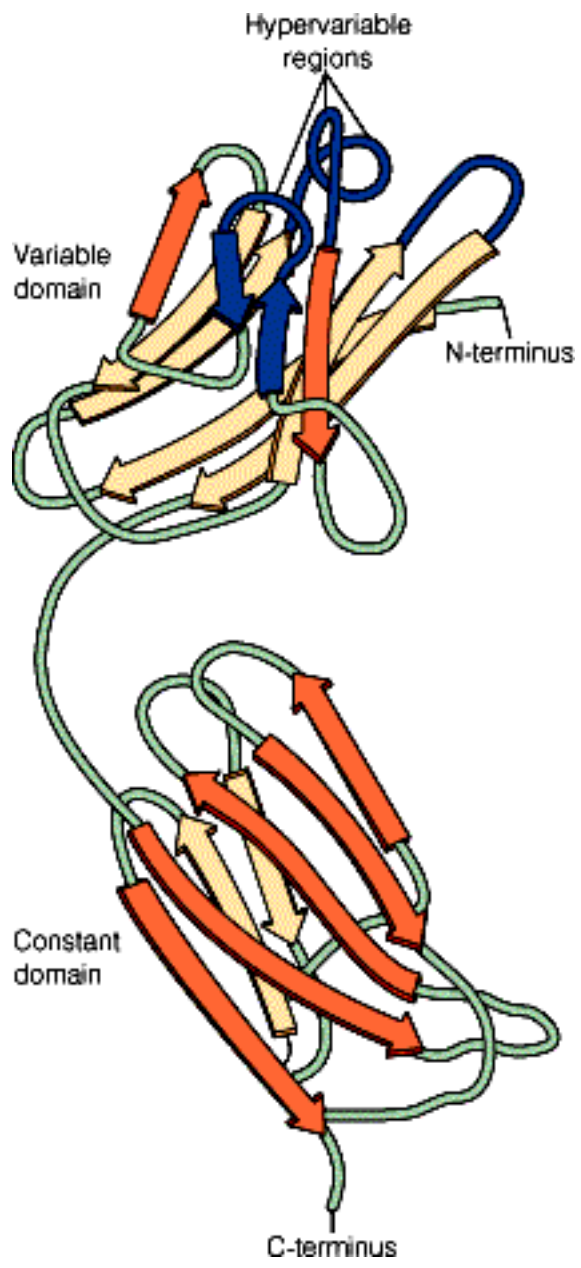

Figure 7.36: The immunoglobulin fold.



From C. Branden and J. Tooze, Introduction to Protein Structure (New York:Garland Publishing 1991), p. 187. © 1991 Garland Publishing.

AIDS and the Immune Response

AIDS (acquired immune deficiency syndrome) is a disease of the immune system caused by the human immunodeficiency virus, or HIV ([Figure 7.37b](#)), which attacks a number of kinds of cells but is particularly virulent toward a class of helper T cells.

T-cell Infection - HIV wages a long battle with rapidly replicating T cells, but eventually the rate of cell destruction exceeds the rate of replication. The consequence is a deterioration of the whole immune response, in particular the ability of B cells to proliferate in response to antigen stimulation. In addition, there is a general failure in T-cell activation.

Most **AIDS** patients succumb either to diseases they could have easily resisted before contracting **AIDS** or to certain kinds of cancer. **AIDS** is so deadly because it attacks our most fundamental defenses against all disease.

High Mutation Rate - Mutations occur in the AIDS genome at a rate many times higher than in the human genome, thwarting efforts to develop a cure. To better understand the magnitude of the problem, consider that a life-long "flu" vaccine has never been developed because of the variability of the influenza virus. HIV mutates about 60 times faster than the influenza virus.

Because of the difficulty in producing safe and effective vaccines, and because HIV infection has already spread so widely, huge efforts have been made to produce a therapy. The efforts that have been most successful so far have used a combination of approaches. On the one hand, the replication of the virus can be slowed by specific inhibitors of [reverse transcriptase](#) (see [here](#) and [here](#)). A quite different approach uses a protease inhibitor to block a proteolytic step essential in the maturation of new viruses within the infected cells.

See also: [T Cells and the Cellular Response](#), [HIV](#)

INTERNET LINKS:

1. [HIV | In Site](#)
 2. [AIDS and HIV Information Resource](#)
 3. [HIV Protease Image](#)
-

Figure 7.37b: Schematic model of HIV

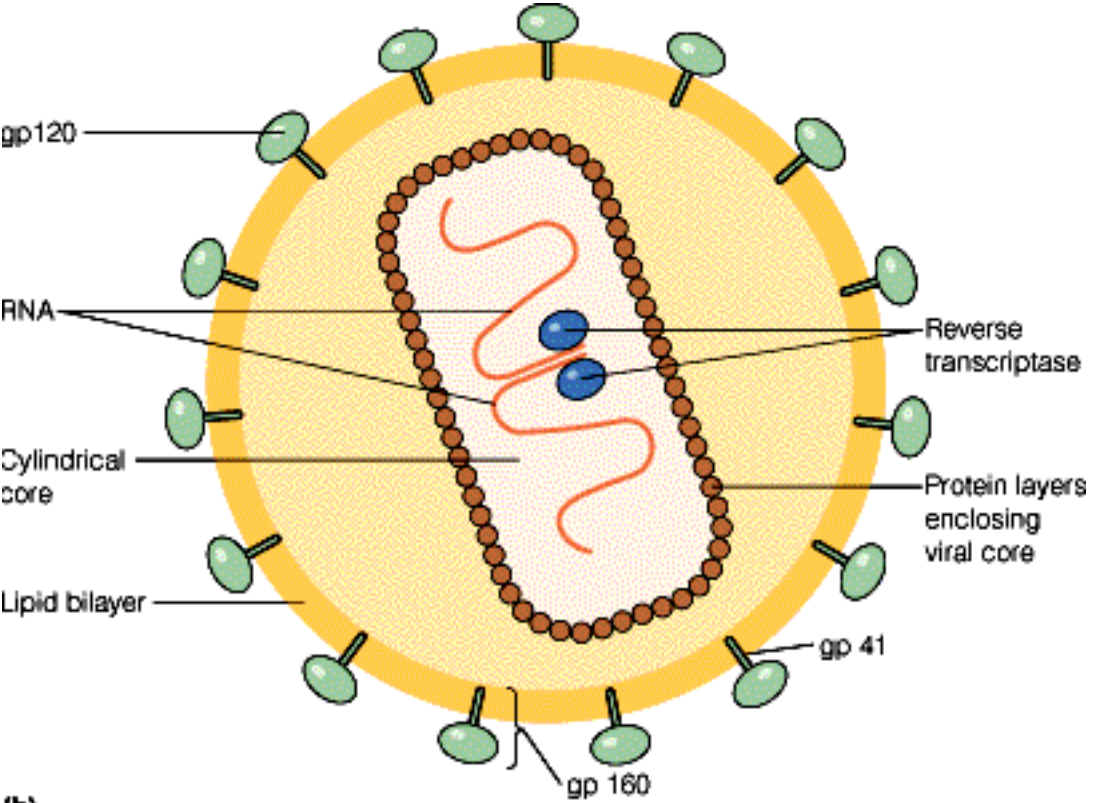

(b)

(a) Courtesy of Hans Gelderblom; (b) From Hoth, Jr., Myers, and Stein, Hospital Practice 27:9, p. 154. Illustration © Alan D. Iselin.

Human Immunodeficiency Virus (HIV)

AIDS (acquired immune deficiency syndrome) is a disease of the immune system. It is caused by the human immunodeficiency virus, or **HIV**, which attacks a number of kinds of cells but is particularly virulent toward a class of helper T cells. The virus wages a long battle with rapidly replicating T cells, but eventually the rate of cell destruction exceeds the rate of replication. The consequence is a deterioration of the whole immune response, in particular the ability of B cells to proliferate in response to antigen stimulation. In addition, there is a general failure in T-cell activation. Most **AIDS** patients succumb either to diseases they could have easily resisted before contracting **AIDS** or to certain kinds of cancer. **AIDS** is so deadly because it attacks our most fundamental defenses against all disease.

Because **AIDS** poses such a grave threat to world health, searches for a vaccine are being intensely pursued. Such searches entail unusual problems, for the **AIDS** virus has an unparalleled capacity to mutate and thus develop strains resistant to any vaccine. Mutations occur in the **AIDS** genome at a rate many times higher than in the human genome. The genetic variation is increased by the many virus replication cycles. The magnitude of the problem can be grasped by considering our experience with the influenza virus. We have never been able to produce an effective "flu" vaccine because of the great variability of the influenza virus. **HIV** mutates about 60 times faster than the influenza virus.

See also: [AIDS and the Immune Response](#), [AZT](#), [Reverse Transcriptase](#)

INTERNET LINKS:

1. [HIV | In Site](#)
 2. [AIDS and HIV Information Resource](#)
-

Antigens

An **antigen** is a substance that can elicit a specific immune response. A foreign particle in the body, such as a virus, bacterium, or protein can be an antigen. **Antigens** bind to specific antibodies. Typically, only a part of the antigen molecule is bound by an antibody. This part of the antigen is called the **antigenic determinant**.

See also: [Antibody Structure](#), [The Immune Response](#), [T Cells and the Cellular Response](#), [Clonal Selection Theory](#), [Immunoglobulins](#)

INTERNET LINKS:

1. [The Latest in Antibody News](#)
 2. [Antibody Resource Page](#)
-

UDP-N-Acetylgalactosamine

UDP-N-Acetylgalactosamine is a nucleotide derivative of **N-acetylgalactosamine** that is an intermediate in the biosynthesis of **sialic acid** (**Figure 16.14**).

UDP-N-acetylgalactosamine is also used to add **galactose** residues in synthesis of O-linked oligosaccharides of glycoproteins (**Figure 16.15**)

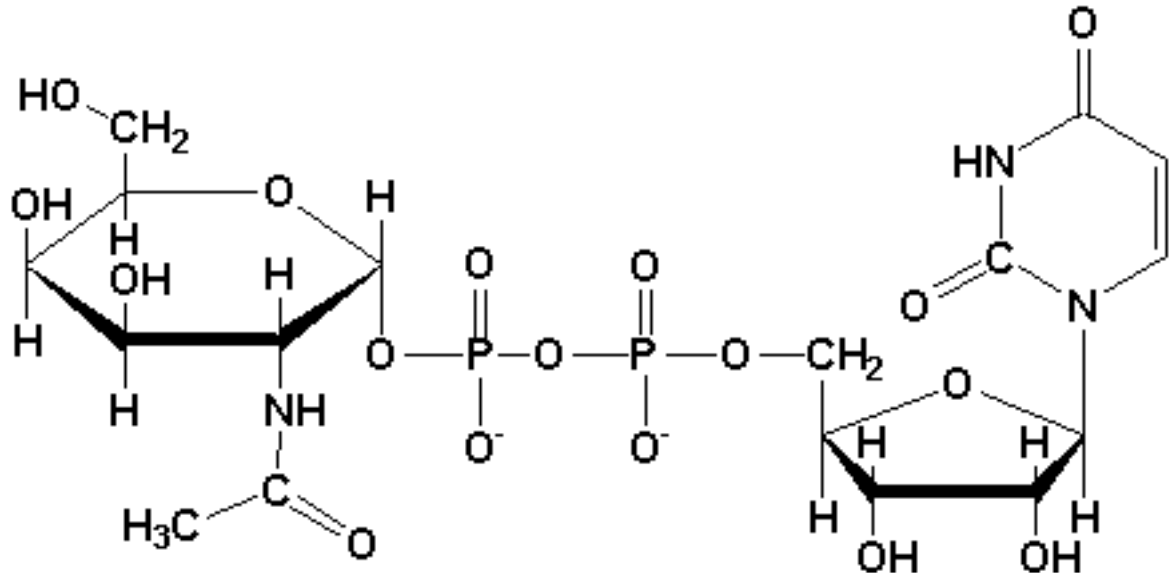

UDP-N-acetylgalactosamine

See also: [Glycoproteins](#), [Biosynthesis of Glycoconjugates](#)

D-Galactosamine

D-Galactosamine is a simple amine sugar made by replacing the hydroxyl at position two of galactose with an amine group.

See also: Derivatives of Monosaccharides, Biosynthesis of Amino Sugars

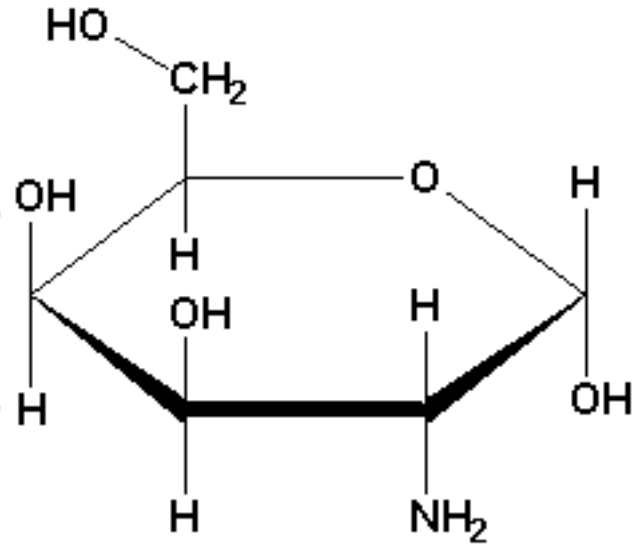

D-Galactosamine

Amygdalin

Amygdalin is an O-linked glycoside found in the seeds of bitter almonds. Its poisonous nature results from the release of cyanide upon hydrolysis. **Amygdalin** is commonly called Laetrile.

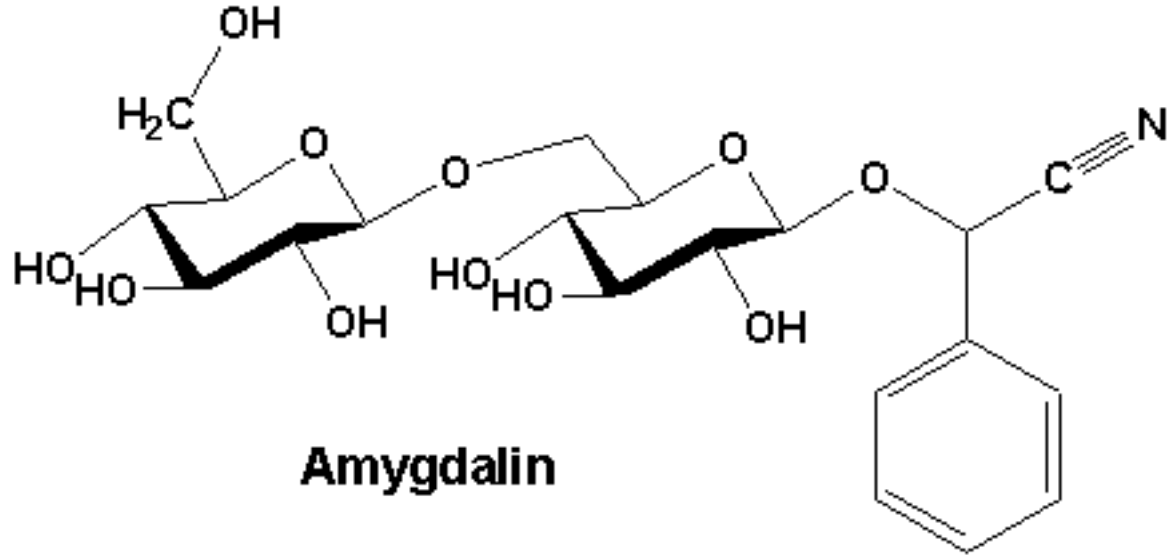

See also: [Figure 9.15](#),
[Glycosides](#)

Figure 9.15: Two naturally occurring glycosides.

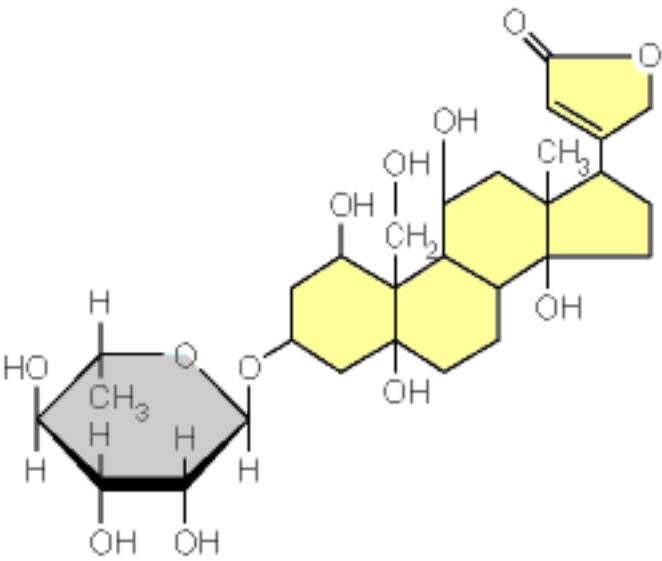

Ouabain

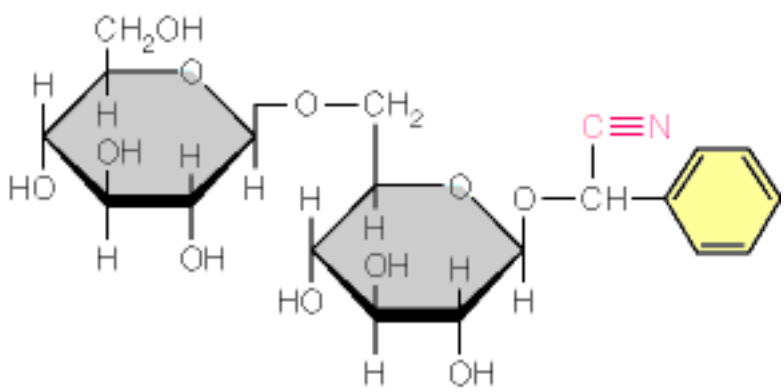

Amygdalin

Protein Targeting

Eukaryotic cells contain several organelles. Each organelle, in turn, requires specific proteins, only a few of which are synthesized within the organelles themselves.

Proteins synthesized in the cytoplasm - These include proteins destined for the cytoplasm and those to be incorporated into mitochondria, chloroplasts, or nuclei. Newly synthesized proteins targeted to mitochondria (the chloroplast mechanism is probably similar) contain specific signal sequences (i.e., specific amino acid sequences) at their N-terminal ends. The signal sequences probably aid in membrane insertions, but they also signal that these polypeptides will interact with a particular class of **chaperonins** (see [here](#)). These chaperones are members of the "heat shock" HSP70 family, which act to insure that the newly synthesized protein remains unfolded and is delivered to a receptor site on the organelle membrane. The unfolded protein then passes through gates in the inner and outer membranes which discriminate between proteins destined for the lumen, the membrane, or the matrix. If it passes into the matrix, the protein may be taken up by intra-organelle chaperonins for final folding. The N-terminal targeting sequence is also cleaved off during this transport ([Figure 28.38](#)).

Proteins Synthesized on the rough [endoplasmic reticulum](#) - Proteins destined for cellular membranes, lysosomes, or extracellular transport use a special distribution system involving the rough endoplasmic reticulum (RER) and the Golgi complex. The RER is a network of membrane-enclosed spaces within the cytoplasm, which is heavily coated on the outer, cytosolic surface with polyribosomes, giving the membrane its rough appearance. The Golgi complex resembles the RER in that it is a stack of thin, membrane-bound sacs, but the Golgi sacs are not interconnected, nor do they carry polyribosomes on their surfaces. The Golgi complex acts as a "switching center" for proteins with various destinations.

Proteins to be directed to their destinations via the Golgi complex are synthesized by polyribosomes associated with the RER as follows:

1. Synthesis begins ([Figure 28.38](#)) when an N-terminal hydrophobic signal sequence is synthesized by **ribosomes** on cytoplasmic **mRNA**.
2. Signal recognition particles (SRPs), containing several proteins and a small (7SL) RNA, recognize the signal sequences of the appropriate nascent proteins and bind to them as they are being extruded from the ribosomes. The SRP temporarily halts translation, so that no more than the N-terminal signal sequence extends from the ribosome and recognizes a docking protein in the RER membrane.
3. The docking protein binds the ribosome to the RER, and the signal sequence is inserted into the RER membrane.

4. The SRP is released ([Figure 28.38](#), step 4), allowing translation to resume.
5. The protein being synthesized is actually pulled through the membrane by an ATP-dependent process.
6. Before translation is complete, signal sequences are cleaved from some proteins by an RER-associated protease. These proteins are released into the lumen of the RER and further transported. Proteins that will remain in the endoplasmic reticulum have resistant signal peptides and thereby remain anchored to the RER membrane.

Role of the Golgi complex - In the lumen of the RER, proteins undergo the first stages of glycosylation. Vesicles carrying these proteins bud off the RER and move to the Golgi complex ([Figure 28.40](#)) where the carbohydrate moieties of glycoproteins are completed (see [here](#)). The membrane sacs of the Golgi complex are a multilayer arena for sorting modified proteins. Vesicles from the RER enter at the *cis* face of the Golgi complex (that closest to the RER) and fuse with the Golgi membrane. Proteins are then passed, again via vesicles, to the intermediate layers. Finally, vesicles bud off from the *trans* face of the Golgi complex (that furthest from the RER) to form lysosomes, peroxisomes, or glyoxysomes or to travel to the plasma membrane.

Vesicle targeting - Vesicle transport of proteins from the Golgi complex requires high specificity in targeting, for transport of vesicles to the wrong destinations would cause cellular chaos. Each kind of protein carbon packed in a vesicle is marked by specific vesicle membrane proteins. In some cases, target membranes contain complementary proteins (called SNARES), which interact with the vesicle and cause membrane fusion and accurate delivery of the cargo proteins ([Figure 28.41](#)).

See also: [Covalent Modification of Proteins](#) (from Chapter 27), [Polypeptide Chain Folding](#) (from Chapter 27)

INTERNET LINKS:

1. [Signal Recognition Particle Database](#)
 2. [The Chaperonin Home Page](#)
 3. [Protein Folding](#)
-

Figure 28.38: A schematic view of steps in the delivery of a protein, synthesized in cytosol, to the matrix of an organelle.

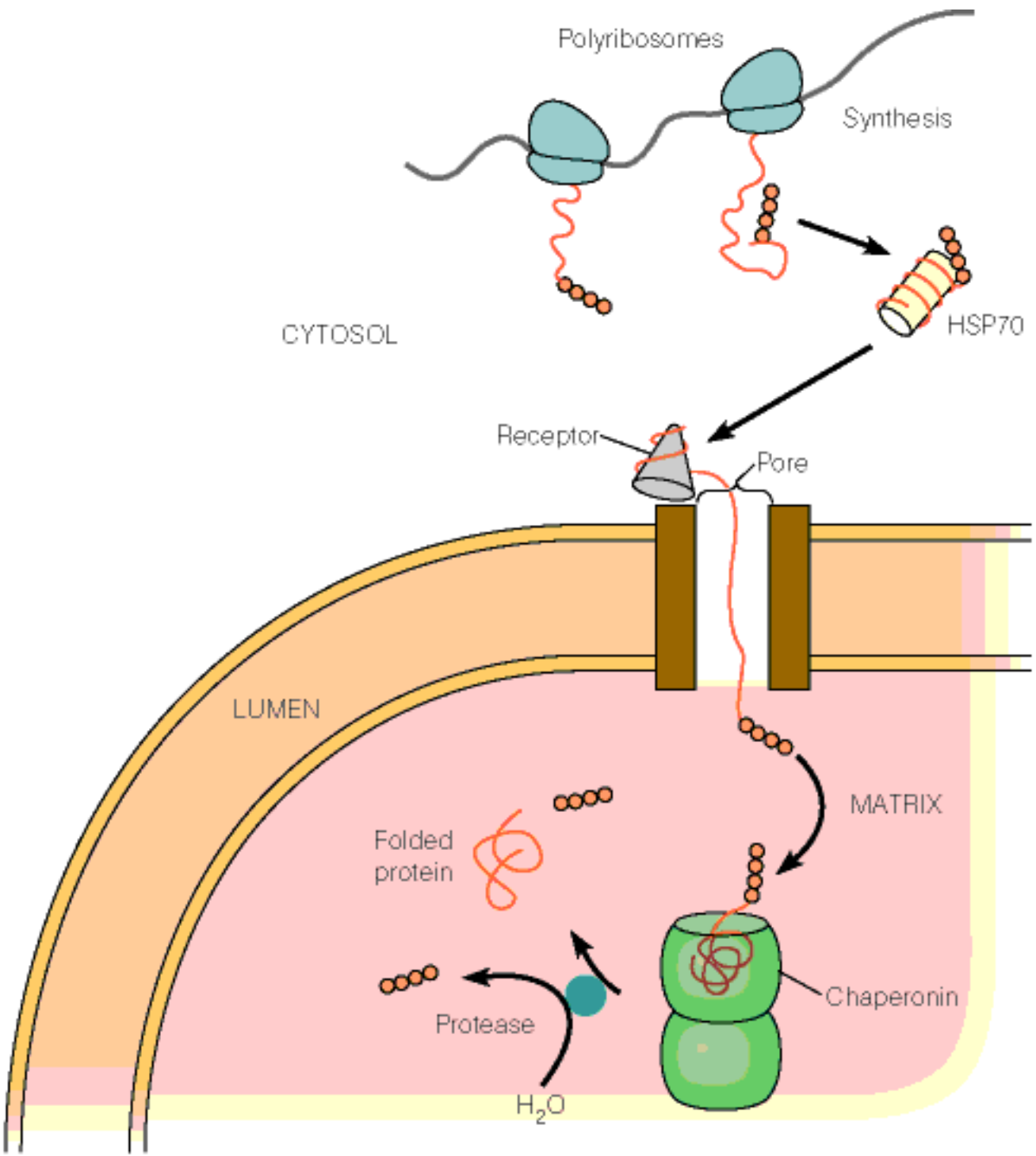

Figure 28.40: Transfer from the rough endoplasmic reticulum (RER) to the Golgi complex.

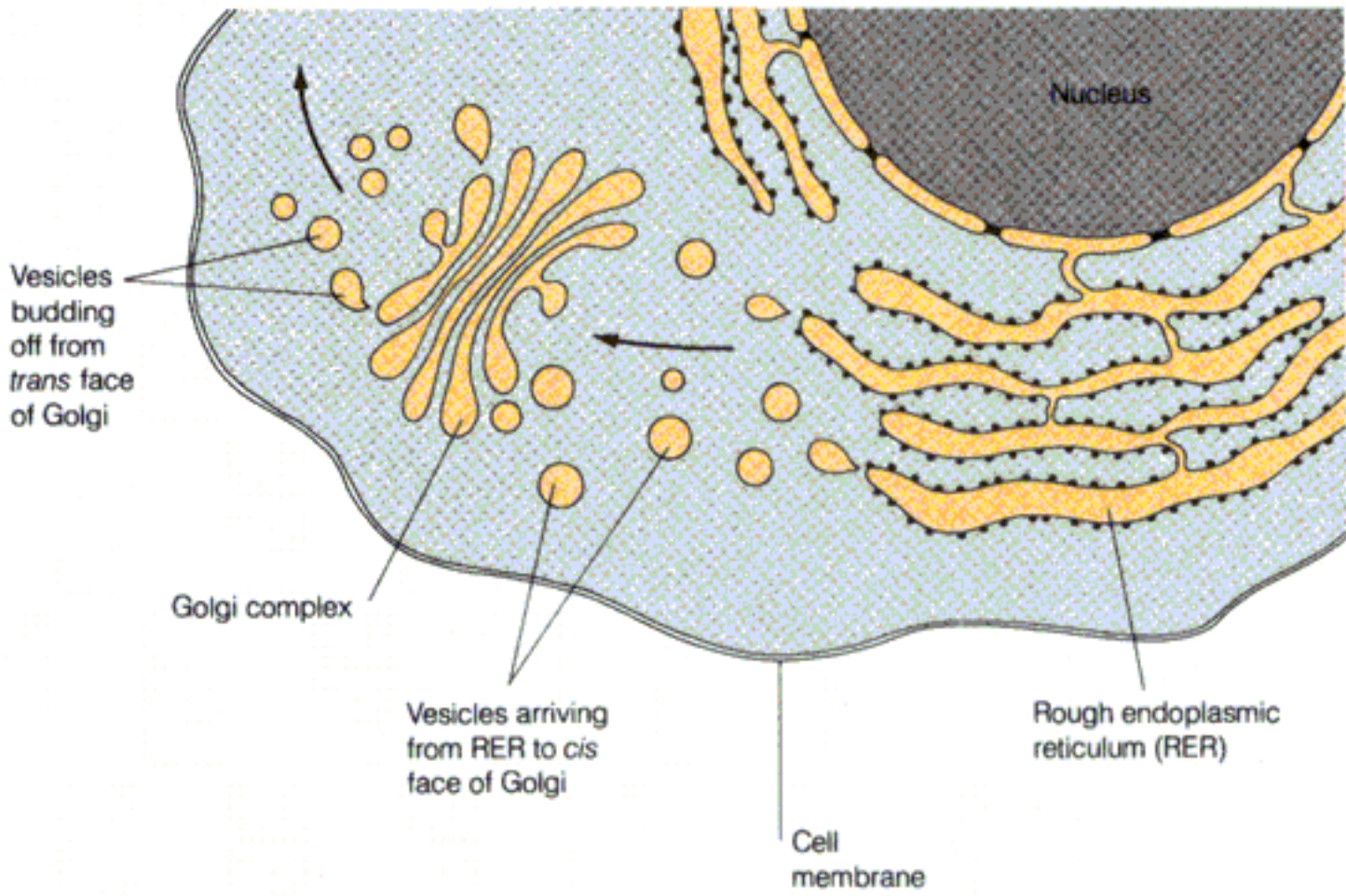
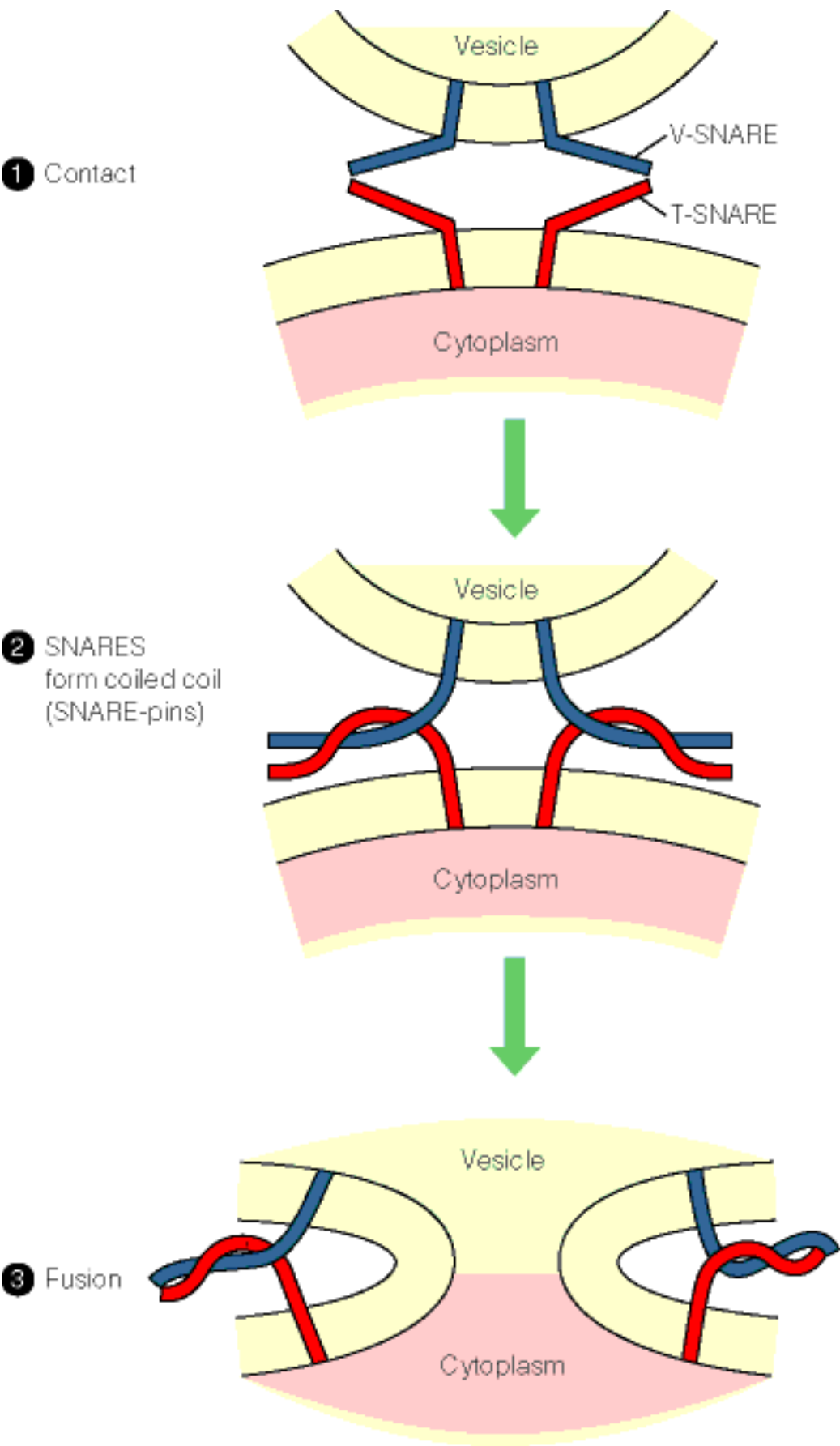
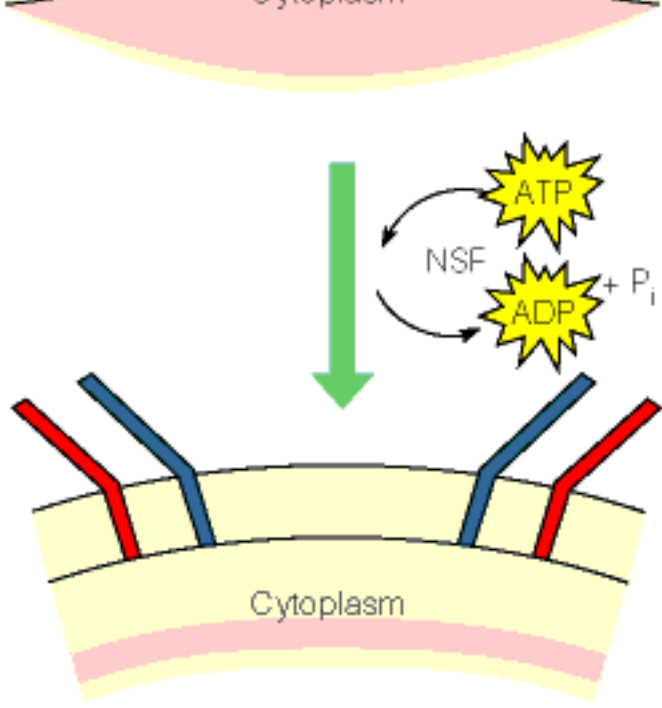

Figure 28.41: A schematic, and somewhat hypothetical, view of SNARE-pin fusion.





4 Dissociation of complexes, vesicle taken up

Ubiquitin

Ubiquitin is a small (76-residue), heat-stable protein found in all eukaryotic cells. It derives its name from its widespread (ubiquitous) distribution. **Ubiquitin** undergoes an ATP-dependent reaction with proteins, which condenses C-terminal **glycine** residues of **ubiquitin** with **lysine** amino groups on the target protein, as shown in **Figure 20.11**. Such modified proteins are degraded soon afterward, by a large protease complex whose assembly requires more **ATP** and that recognizes the **ubiquitin** marker.

See also: **Protein Turnover**, **Programmed Destruction of Proteins** (from Chapter 28)

Figure 20.11: Programmed destruction of cytosolic proteins by the ubiquitin marking system.

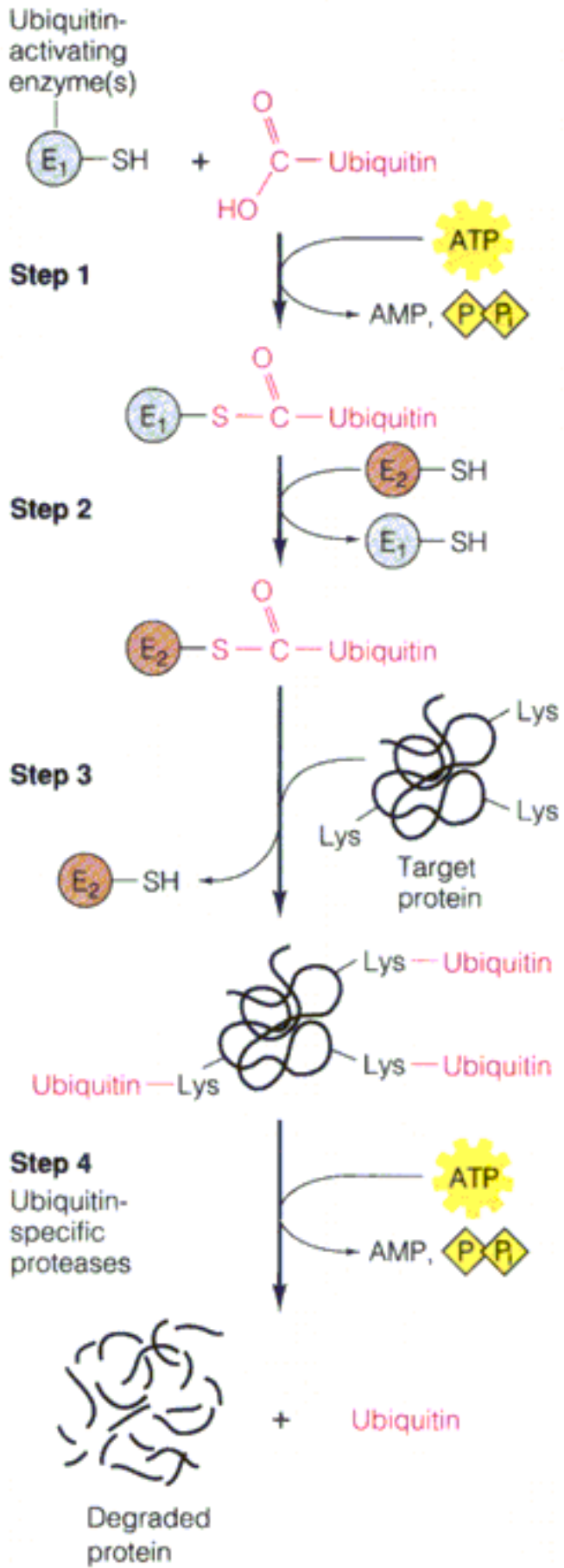



Degraded
protein

Protein Turnover

In a typical day, a person who is in nitrogen balance will consume 100 grams of **protein**, break down 400 grams of bodily **protein**, resynthesize 400 grams of **protein**, and excrete/catabolize 100 grams. Individual proteins exhibit tremendous variability in their metabolic lifetimes, from a few minutes to a few months. Protein degradation obeys first order kinetics. For a particular **protein**, individual molecules are degraded at random, such that a semilogarithmic plot of isotope remaining in a **protein** versus time is linear. Thus, we can determine the metabolic half-life of a particular **protein**. In a rat the average **protein** has a half-life of 1 or 2 days. [Table 20.2](#) gives information about the half-lives of several **proteins**.

Proteins in extracellular environments, such as digestive enzymes, polypeptide hormones, and antibodies, turn over quite rapidly, but **proteins** with predominantly structural roles, such as collagen of connective tissue, are much more stable.

Enzymes catalyzing rate-determining steps in metabolic pathways are also short-lived. Protein breakdown may thus be an important regulatory mechanism for a protein.

In cells, protein degradation appears to focus on proteins that have become chemically altered in some way. In bacteria, mutant proteins are degraded much more rapidly than their wild-type counterparts. Extensive proteolysis is one of the events interlinked with sporulation. In this case, the amino acids released are used to synthesize proteins of the spore. Specific endopeptidase reactions are known to be involved in enzyme activation (for example, blood clotting), regulation of gene expression, response to environmental stress, and participation in cell signalling pathways. Selective proteolytic reactions in signalling pathways lead to apoptosis, a process in normal development in which certain cells undergo a preprogrammed death.

Intracellular Proteases - Proteolytic enzymes are found throughout the cell. Several proteases are present in the eukaryotic cytosol—two Ca^{2+} activated proteases called calpains, a large multisubunit neutral protease, and a still larger ATP-dependent protease called the proteasome ([Figure 20.10](#)). Lysosomal proteases, called cathepsins, are designed to function in an acidic milieu. Lysosomes form by budding from the Golgi complex and are bags of digestive enzymes containing proteases, nucleases, lipases, and carbohydrate cleaving enzymes. Lysosomes are involved in secretion of digestive enzymes, digestion of organelles destined for destruction, digestion of food particles or bacteria engulfed by phagocytosis, and intracellular release of enzymes followed by autolysis—digestion and death of the cell.

Four structural features are currently thought to be determinants of turnover rate:

Ubiquitination - [Ubiquitin](#) is a 76-amino acid residue heat-stable protein found in all eukaryotic cells. An ATP-dependent reaction with proteins links ubiquitin's C-terminal glycine to lysine amino groups in the target protein ([Figure 20.11](#)). Proteins modified in

this way are degraded soon afterward.

Oxidation of amino acid residues - Conditions that generate oxygen radicals cause many proteins to undergo mixed-function oxidation of particular residues. Conditions require Fe^{2+} and hydroxyl radical, and the amino acids most susceptible to oxidation are lysine, arginine, and proline. *E. coli* and rat liver each contain a protease that cleaves oxidized glutamine synthetase in vitro, but does not attack the native enzyme. Presumably, other oxidized proteins are also targets for this enzyme.

PEST sequences - Virtually all short-lived proteins (i.e., half-lives less than 2 hours) contain one or more regions rich in proline, glutamate, serine, and threonine. These regions are called PEST sequences because the one-letter codes for these amino acids are P, E, S, and T, respectively. Very few longer-lived proteins contain these sequences. Furthermore, insertion of these sequences into long-lived proteins increases their metabolic lability.

N-terminal amino acid residue - An N-terminal protein residue of Phe, Leu, Tyr, Trp, Lys, or Arg is correlated with short metabolic lifetimes. Proteins with other termini are far longer-lived. Thus, the intracellular half-life of a particular protein depends on the identity of its N-terminal amino acid residue.

See also: [Amino Acid Degradation](#), [The Nitrogen Cycle](#), [Cathepsins](#), [Calpains](#),

INTERNET LINK: [The Proteasomes](#)

Table 20.2



Half-life (hours)	Intracellular Location			
	Nucleus	Cytosol	Mitochondria	Endoplasmic Reticulum and Plasma Membrane
<2	Oncogene products	Ornithine decarboxylase, tyrosine aminotransferase, protein kinase C	δ -Aminolevulinic acid synthetase	HMG-CoA reductase
2–8	—	Tryptophan oxygenase, cAMP-dependent protein kinase	—	γ -Glutamyl transferase
9–40	Ubiquitin	Calmodulin, glucokinase	Acetyl-CoA carboxylase, alanine aminotransferase	LDL receptor, cytochrome P450
41–200	Histone H1	Lactate dehydrogenase, aldolase, dihydrofolate reductase, phytochrome P670	Cytochrome oxidase, pyruvate carboxylase, cytochrome <i>c</i>	Cytochrome <i>b</i> ₅ , cyt <i>b</i> ₅ reductase
>200	Histones H2A, H2B, H3, H4	Hemoglobin, glycogen phosphorylase	—	Acetylcholine receptor

Source: From M. Rechsteiner, S. Rogers, and K. Rote, *Trends Biochem. Sci.* (1987) 12:390–394. © 1987 with permission from Elsevier Science.

Note: This table represents just a few examples of the many proteins whose half-lives have been determined in different organisms.

Figure 20.10: Structure of the proteasome.

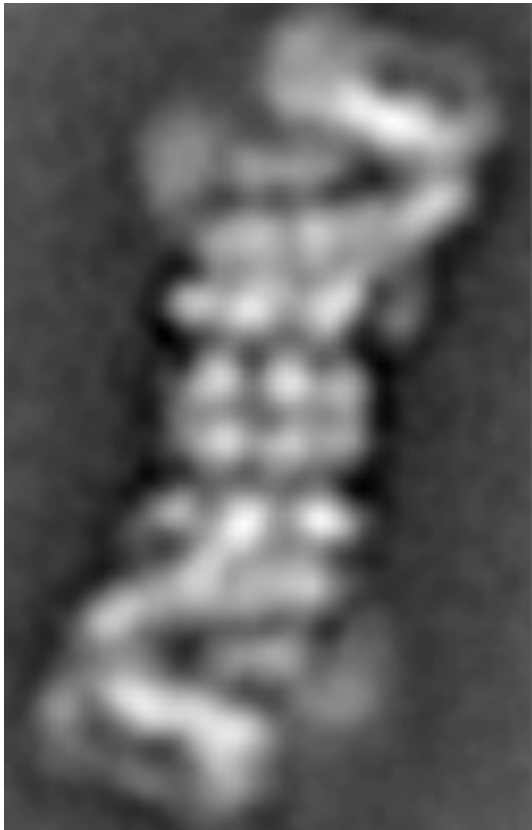

Courtesy of W. Baumeister from A. Lupas, J. M. Flanagan, T. Tamura, and W. Baumeister, Trends Biochem. Sci. (1997) 22:399-404, with permission from Elsevier Science.

Amino Acid Degradation

With few exceptions, the first step in **amino acid degradation** is removal of the α -amino group. This modification, usually a **transamination**, can also be used to generate **glutamate** from α -**ketoglutarate** via the **glutamate dehydrogenase** reaction. The products of these reactions include deamination of the amino acid to the corresponding keto acid plus ammonia. **L-amino acid oxidase** also catalyzes a similar reaction, yielding a hydrogen peroxide intermediate, as shown **here**. Kidney and liver cells are also rich in a D-amino acid oxidase, which has an unknown function, because D isomers of amino acids are rare except for in bacterial cell walls.

After the nitrogen group has been removed from the molecules, the carbon backbone can be metabolized in a variety of ways (**Figure 20.12**). **Amino acids** whose skeletons generate **pyruvate** or **oxaloacetate** are efficiently converted to carbohydrates via **gluconeogenesis**. **Amino acids** leading to **acetyl-CoA** or **acetoacetyl-CoA** contribute towards **ketogenesis**. The terms glucogenic and ketogenic are used to classify **amino acids** as generators of carbohydrates (see **here**) or **ketone bodies**, respectively.

See also: [Urea Cycle](#), [Protein Turnover](#), [Ammonia Transport in the Body](#), [Coenzymes in Nitrogen Metabolism](#), [Transamination in Amino Acid Metabolism](#)

INTERNET LINK: [Amino Acid Metabolism](#)

Transaminases (Aminotransferases)

Transaminase is a name for a category of enzymes involved in exchange of an oxygen from an α -keto acid (such as α -ketoglutarate) and an amine from an amino acid (see [here](#)). **Aminotransferases** utilize a coenzyme, **pyridoxal phosphate**, that is derived from vitamin B6. The functional part of the cofactor is an aldehyde functional group, -CHO, attached to a pyridine ring. Catalysis begins with condensation of this aldehyde with the amino group of an amino acid, to give a Schiff base, or aldimine, intermediate, followed by formation of a resonance-stabilized carbanion with a quinonoid structure, as shown in [Figure 20.15](#). Depending on the bond labilized, formation of the aldimine can lead to a **transamination**, to decarboxylation, to racemization, or to numerous side chain modifications, such as β -elimination.

Example **transamination** reactions are as follows:



Example **aminotransferase** enzymes include the serum glutamate-oxaloacetate transaminase ([SGOT](#)) and serum glutamate-pyruvate transaminase ([SGPT](#)).

See also: [Transamination in Amino Acid Metabolism](#), [Amino Acids](#), [\$\alpha\$ -Ketoglutarate](#), [De Novo Biosynthesis of Purine Nucleotides](#)

INTERNET LINK: [Urea Cycle and Metabolism of Amino Groups](#)

Serum Glutamate-Oxaloacetate Transaminase (SGOT)

SGOT is a transaminase that catalyzes the reaction:

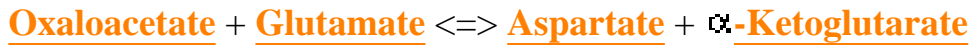

Both **SGOT** and serum glutamate-pyruvate transaminase (**SGPT**) are important in the clinical diagnosis of human disease. These enzymes, abundant in heart and in liver, are released from cells as part of the cell injury that occurs in myocardial infarction, infectious hepatitis, or other damage to either organ. Assays of these enzyme activities in blood serum can be used both in diagnosis and in monitoring the progress of a patient during treatment.

See also: Transamination in Amino Acid Metabolism, Transaminase

Serum Glutamate-Pyruvate Transaminase (SGPT)

SGPT is a transaminase that catalyzes the reaction:

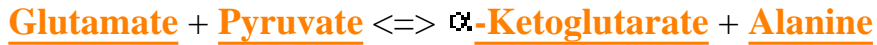

Both **SGPT** and serum glutamate-oxaloacetate transaminase (SGOT) are important in the clinical diagnosis of human disease. These enzymes, abundant in heart and in liver, are released from cells as part of the cell injury that occurs in myocardial infarction, infectious hepatitis, or other damage to either organ. Assays of these enzyme activities in blood serum can be used both in diagnosis and in monitoring the progress of a patient during treatment.

See also: [SGOT](#), [Transamination in Amino Acid Metabolism](#)

Unnumbered Item

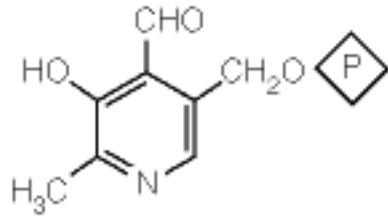

Pyridoxal phosphate

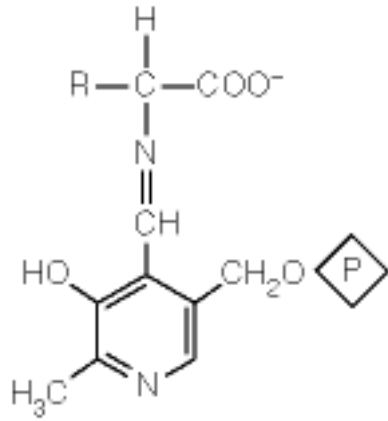

Schiff base between amino acid and pyridoxal phosphate

Unnumbered Item

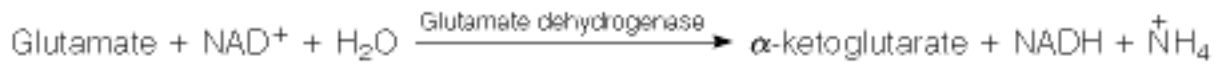
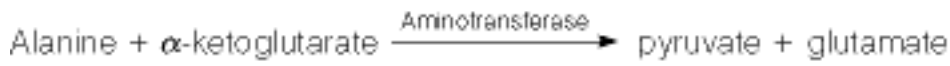

L-Amino Acid Oxidase

L-amino acid oxidase is an enzyme involved in amino acid catabolism. It is a flavoprotein-containing enzyme that catalyzes the reaction below, yielding a hydrogen peroxide intermediate.

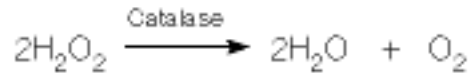
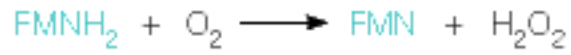
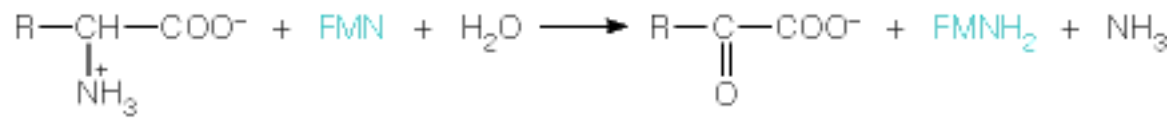

See also: [Amino Acid Degradation](#), [Figure 20.12](#)

Unnumbered Item

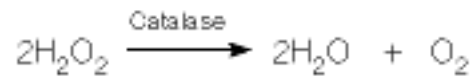
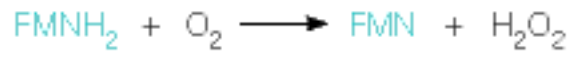
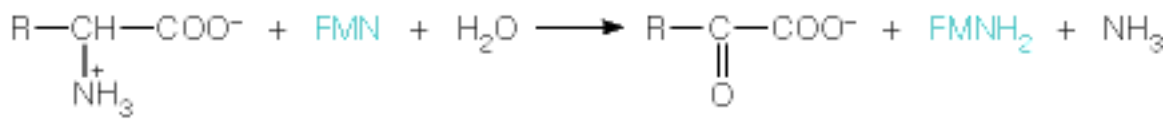

Ammonia Transport in the Body

Ammonia, produced in animal cells as a result of catabolism, must be transported to the liver for its eventual conversion to urea. **Figure 20.14** shows schematically how amino acids are employed to carry ammonia in the form of amino groups to the liver where it is eventually converted to urea. In most tissues, the toxic ammonia is converted to the nontoxic, and electrically neutral, glutamine. Glutamine is transport in the blood to the liver where it is cleaved hydrolytically by glutaminase in the following reaction:

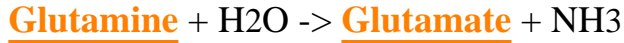

In the muscle, where glycolysis is active, the **glucose-alanine cycle** is used to remove toxic ammonia (**Figure 20.14**). Here **glutamate dehydrogenase** links ammonia to α -**ketoglutarate** to form **glutamate**. Glutamate then donates its amine group to **pyruvate** (from glycolysis) to form alanine and α -ketoglutarate. **Alanine** is transported to the liver, where it loses the amine group by a reversal of the previous processes, yielding ammonia for urea synthesis and pyruvate. Pyruvate, in turn, undergoes **gluconeogenesis** to form **glucose**, which is released to the blood and travels back to the muscles. Thus, muscle gets rid of ammonia and pyruvate and receives glucose (ultimately) in exchange.

See also: [Amino Acid Degradation](#), [Transamination in Amino Acid Metabolism](#), [Utilization of Ammonia](#), [Glucose Alanine Cycle](#)

Figure 20.14: Transport of ammonia to the liver for urea synthesis.

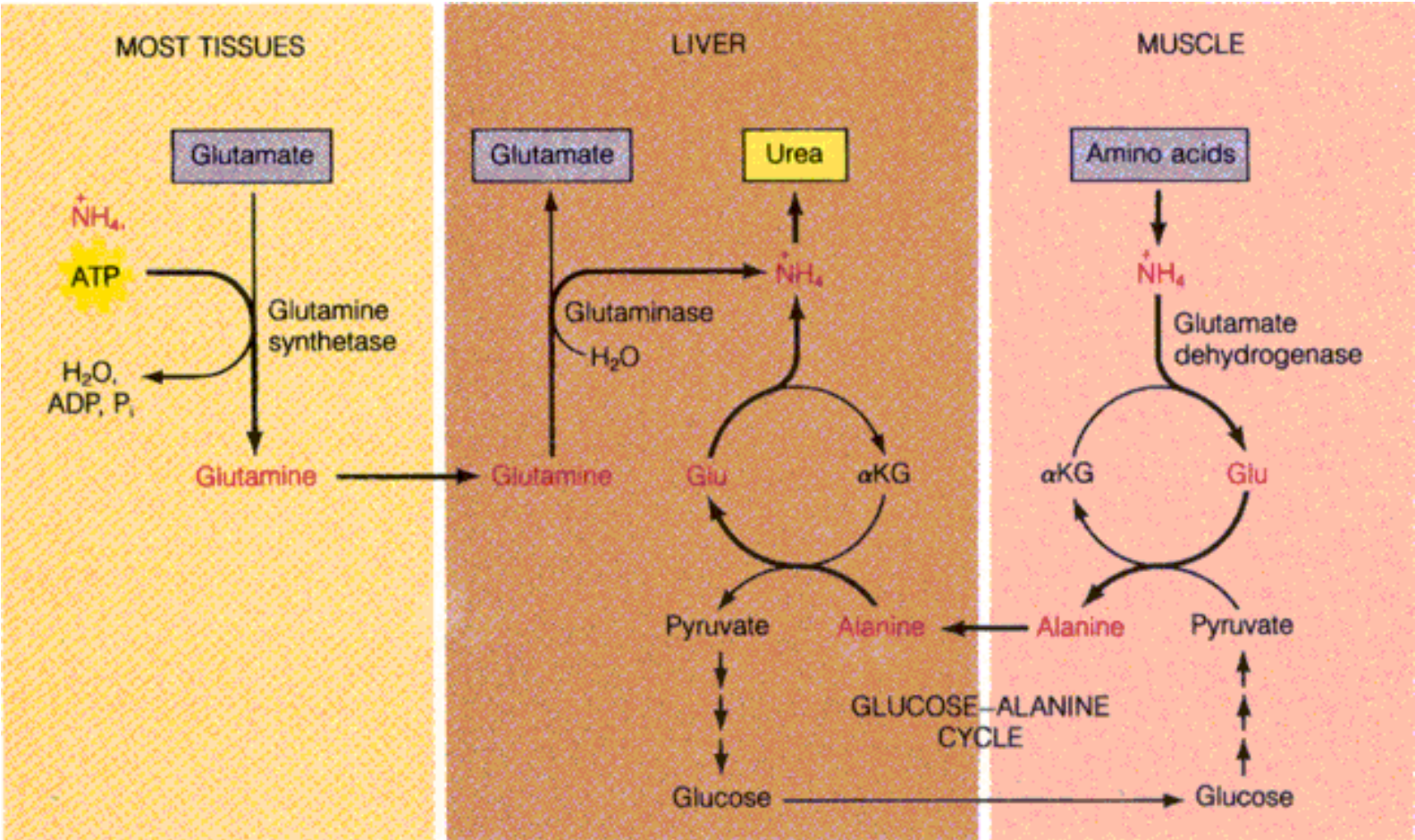

Glucose-Alanine Cycle

The **glucose-alanine cycle** is an important cycle in muscle, where glycolysis is active, because it helps to remove toxic ammonia as it builds up ([Figure 20.14](#)). The cycle operates as follows:

1. [Glutamate dehydrogenase](#) links ammonia to α -[ketoglutarate](#) to form [glutamate](#).
2. [Glutamate](#) donates its amine group to [pyruvate](#) (from [glycolysis](#)) to form [alanine](#) and α -[ketoglutarate](#).
3. [Alanine](#) is transported to the liver, where it loses the amine group by a reversal of the previous processes, yielding ammonia for urea synthesis and [pyruvate](#).
4. [Pyruvate](#) undergoes [gluconeogenesis](#) to form [glucose](#), which is released to the blood and travels back to the muscles.

Thus, muscle gets rid of ammonia and pyruvate and receives glucose (ultimately) in exchange.

See also: [Cori Cycle](#)

The Cori Cycle

The **Cori cycle** ([Figure 16.5](#)) is an organismal mechanism for meeting the glucose needs of a body at exercise. Muscles at work produce [lactate](#) from [glycolysis](#) when oxygen becomes limiting. Lactate is transported from the muscles to the liver via the bloodstream. In the liver, lactate is converted (via [gluconeogenesis](#)) back to [glucose](#), where it is dumped back into the bloodstream for transport to muscle.

See also: [Lactate Dehydrogenase](#), [Glucose-Alanine Cycle](#), [Figure 20.14](#)

Figure 16.5: The Cori cycle.

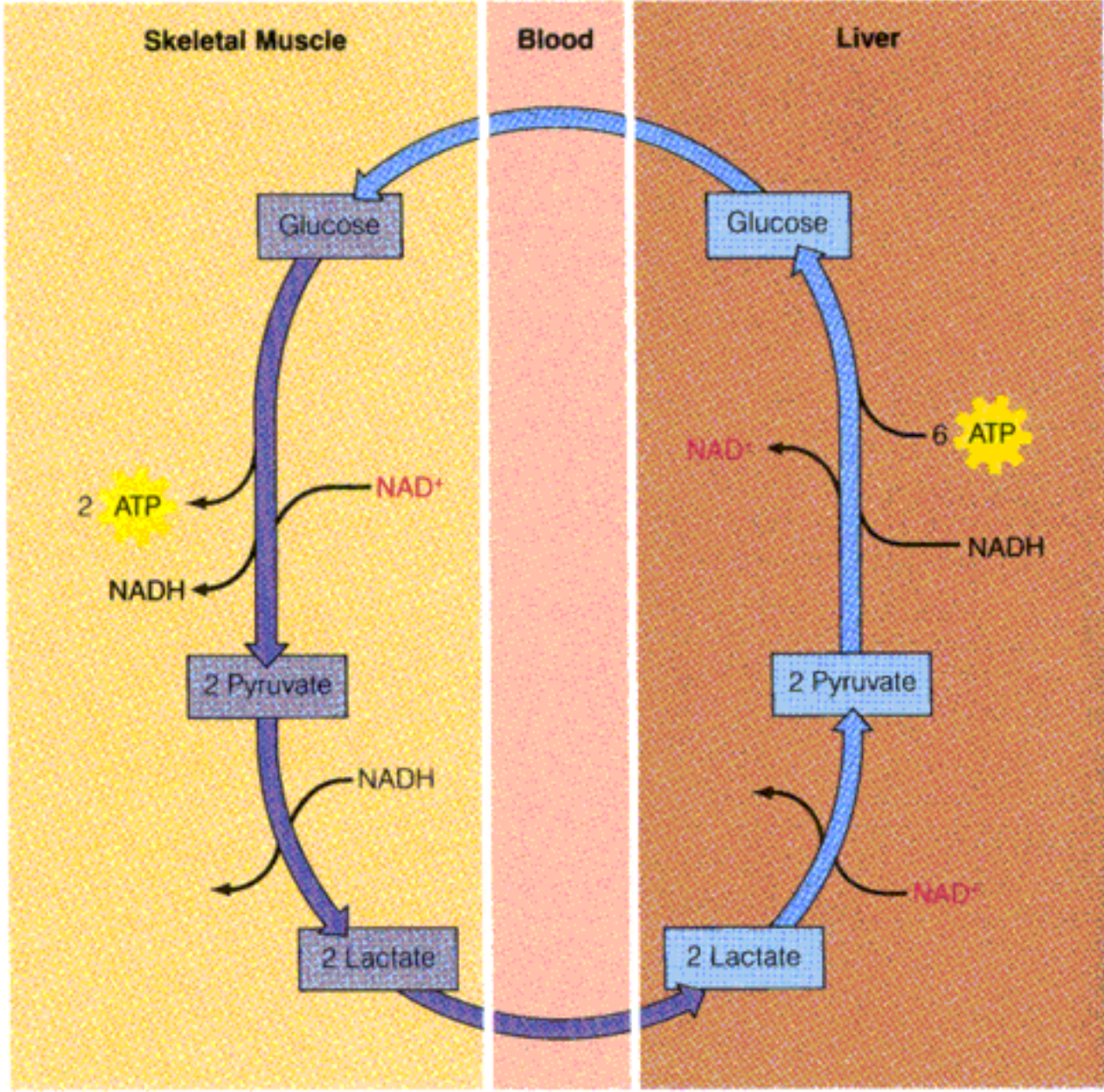

Cathepsins

Cathepsins are lysosomal proteases which are designed to function in an acidic milieu. Although the specific roles of each protease are not yet defined, it seems likely that extracellular proteins taken up by a cell and long-lived cellular proteins are degraded in lysosomes, while selective protein turnover related to metabolic regulation occurs in other compartments.

See also: [Protein Turnover](#), [Programmed Destruction of Proteins](#), [Calpains](#), [Proteasome](#)

INTERNET LINK: [Cathepsin D as a Marker for Breast Cancer](#)

Calpains



Calpains are calcium-activated proteases that participate in turnover of proteins in the cell.

See also: [Protein Turnover](#), [Programmed Destruction of Proteins](#), [Cathepsins](#), [Proteasome](#)

INTERNET LINKS:

1. [Home Page of Calpains](#)
 2. [The EF Hand Calcium-Binding Proteins Data Library](#)
-

Proteasomes

Proteasomes ([Figure 20.10](#)) are cytosolic particles involved in proteolytic digestion. They come in two sizes - 20S and 26S. Structurally the **proteasome** shows remarkable similarity to the GroEL [chaperonin](#). **Proteasomes** degrade cytosolic proteins tagged with [ubiquitin](#).

See also: [Protein Turnover](#), [Programmed Destruction of Proteins](#), [Cathepsins](#), [Calpains](#)

INTERNET LINK: [Structure of the Proteasome](#)

Figure 28.43: The ubiquitination degradation pathway.

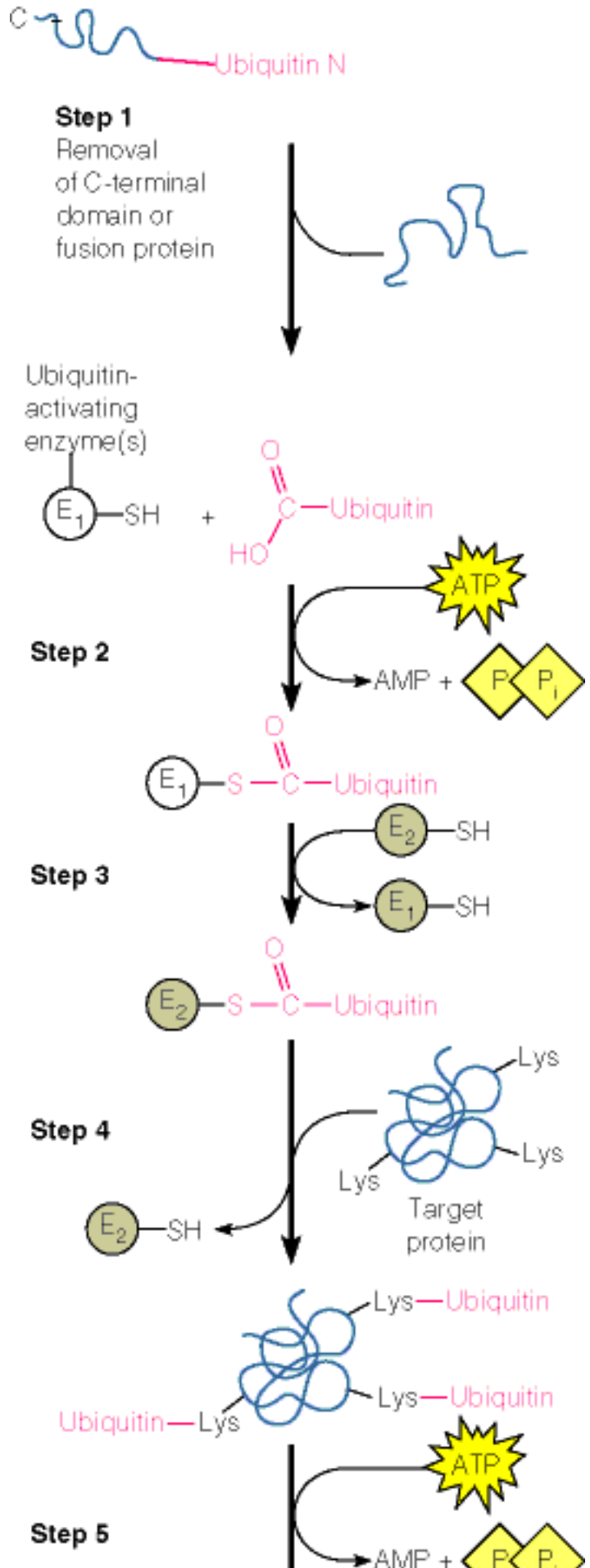

Step 5

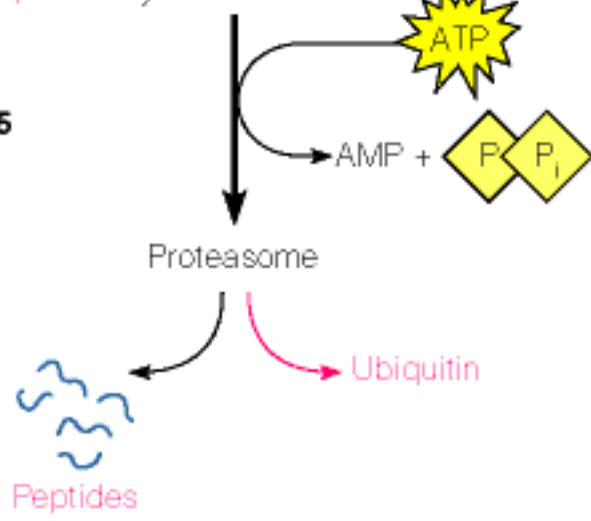
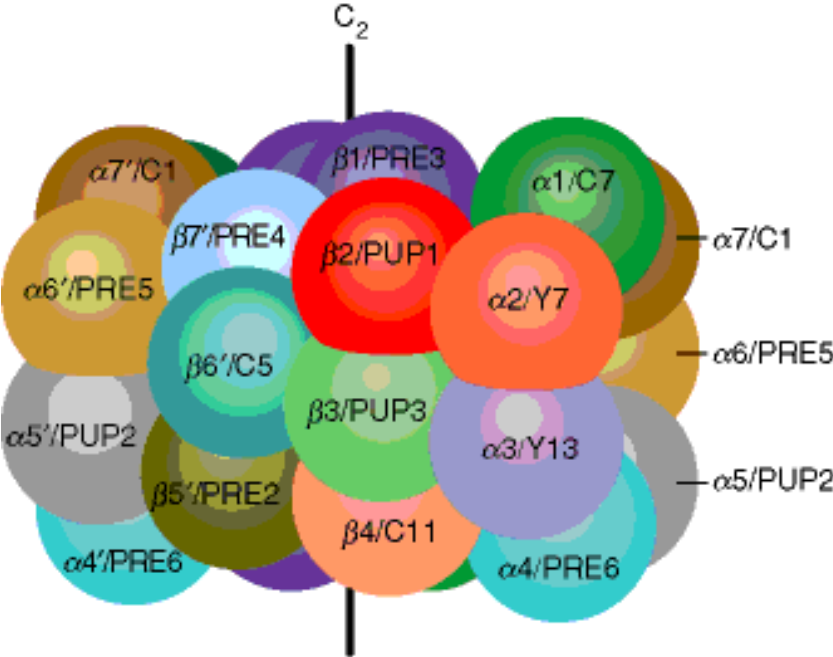
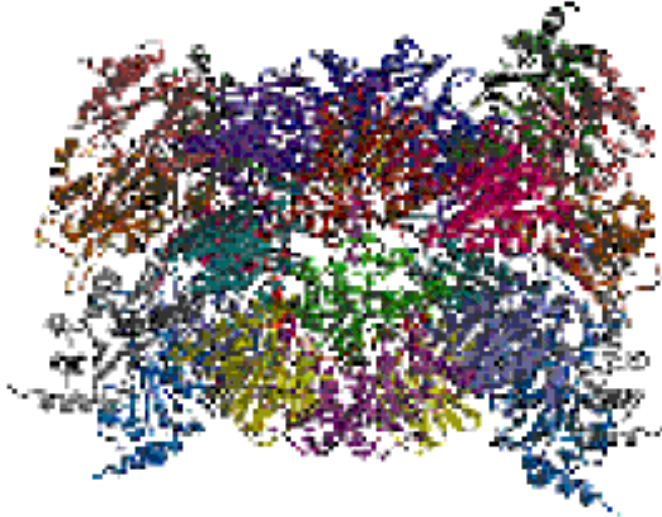

Figure 28.44: Three-dimensional structure of the yeast 20S proteasome.



(a)



(b)

Courtesy of R.Huber from M. Groll et al., Nature (1997) 386: 463-471. © 1997 Macmillan Magazines, Ltd.

Figure 15.25: Enzymatic hydroxylation involving NADPH and cytochrome P450.

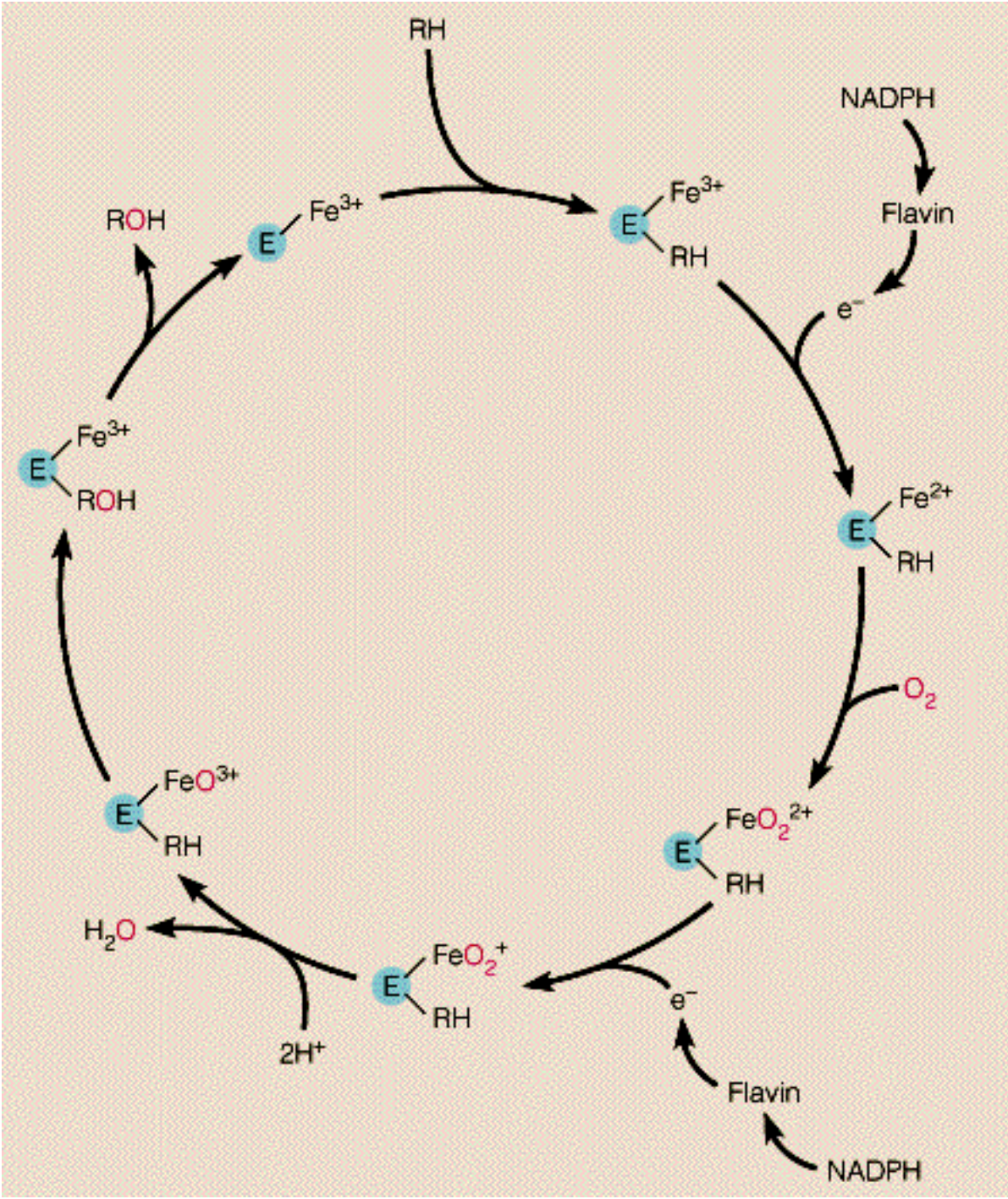

Oxidases and Oxygenases

In most cells, at least 90% of the molecular oxygen consumed is used in **oxidative phosphorylation**. The remaining O₂ is used in a wide variety of specialized metabolic reactions. At least 200 known enzymes use O₂ as a substrate. Because O₂ is rather unreactive, virtually all of these 200 enzymes use a metal ion to enhance the reactivity of oxygen, just as cytochrome oxidase does.

Oxidases - Oxidases are enzymes that catalyze the oxidation of a substrate without incorporating oxygen into the product. A two-electron oxidation is usually involved, so the oxygen is converted to H₂O₂. Most **oxidases** utilize either a metal or a flavin coenzyme. D-amino acid **oxidases** catalyze the following reaction:

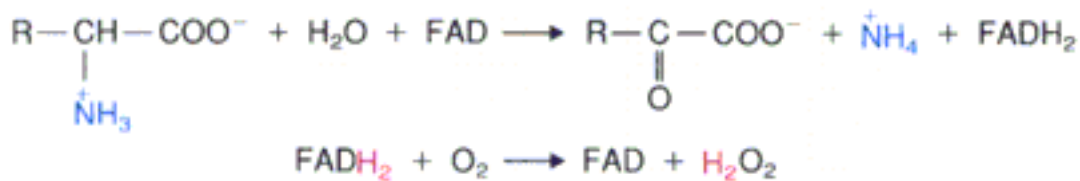

Oxygenases - Oxygenases are enzymes that incorporate oxygen atoms from O₂ into the oxidized products. **Dioxygenases** are uncommon enzymes that incorporate both atoms of O₂ into one substrate. An example is tryptophan 2,3-dioxygenase, which catalyzes the reaction below:

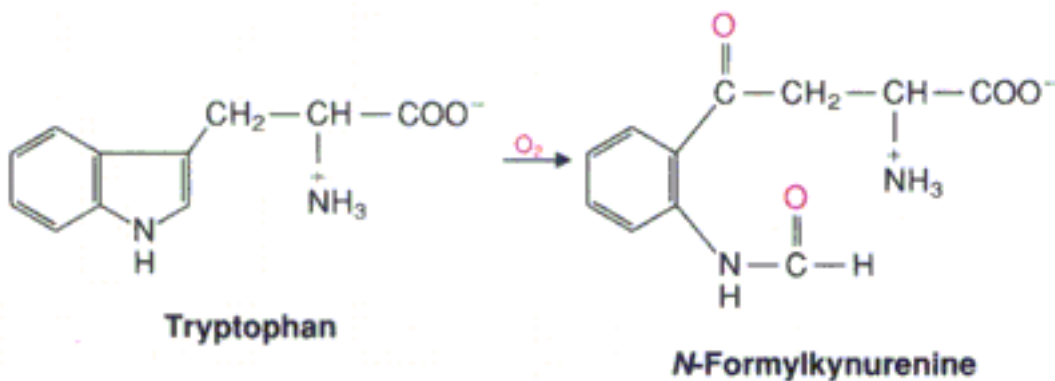

Monoxygenases are much more common than **dioxygenases**. They incorporate one atom from O₂ into a product and reduce the other atom to water. A **monoxygenase** has one substrate that accepts oxygen and another that furnishes the two H atoms that reduce the other oxygen to water. Because two substrates are oxidized, enzymes of this type are also called mixed-function oxidases. The general reaction catalyzed by **monoxygenases** is the following:

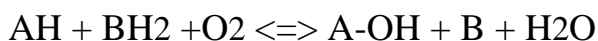

The substrate AH usually becomes hydroxylated by this class of enzymes, so they are also called **hydroxylases**. For example, this type of enzyme is used to hydroxylate steroids.

See also: [Cytochrome P450](#), [Reactive Oxygen](#), [Oxygen Metabolism and Human Disease](#)

Ethylene

Ethylene is a hydrocarbon plant hormone that comes from the methionyl moiety of **S-adenosylmethionine**. **Ethylene** stimulates fruit ripening and the aging of flowers, and it inhibits seedling growth. It also redirects auxin transport (another plant hormone) to promote transverse, rather than longitudinal, growth of plants.

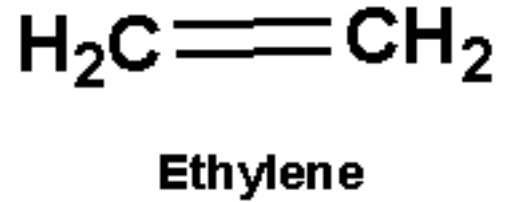

See also: [Plant Hormones](#), [Figure 23.25](#)

INTERNET LINK: [Plant Hormones](#)

Plant Hormones



There are five major classes of plant hormones ([Figure 23.25](#)). They include the following:

1. The diterpene **gibberellins** are derived from [isopentenyl pyrophosphate](#). Some **gibberellins** are also growth-promoting hormones and may stimulate expression of certain genes. Particular messenger RNAs are present in increased amounts as a result of **gibberellin** administration.
2. The sesquiterpene [abscisic acid](#) is also derived from isopentenyl pyrophosphate. **Abscisic acid** counteracts the effects of most other plant hormones. That is, it inhibits germination, growth, budding, and leaf senescence. Physiological evidence suggests a role for **abscisic acid** in ion and water balance.
3. The **cytokinins** are purine bases with a terpenoid side chain. **Cytokinins** are produced in the roots and promote growth and differentiation in many tissues. **Cytokinins** and auxins work together. The ratio of **cytokinin** to auxin is often crucial in determining whether a plant will grow or differentiate.
4. Of the **auxins**, the tryptophan metabolite [indole-3-acetic acid](#) is the most active. **Auxins** are synthesized in apical buds (at the tip) of growing shoots. They stimulate growth of the main shoot and inhibit lateral shoot development. A class of **auxin**-binding membrane proteins may represent **auxin** receptors. **Auxin** action involves pumping protons out of the cell, possibly in conjunction with a membrane ATPase.
5. [Ethylene](#) is a hydrocarbon that comes from the methionyl moiety of [S-adenosylmethionine](#). **Ethylene** stimulates fruit ripening and the aging of flowers, and it inhibits seedling growth. It also redirects auxin transport to promote transverse, rather than longitudinal, growth of plants.

Ethylene and abscisic acid have been shown to function via signalling pathways that involve protein phosphorylation. The abscisic acid pathway involves a signalling component called cyclic ADP-ribose (cADPR), which regulates calcium release in animal cells.

Another plant protein is highly homologous to mammalian steroid 5 α reductases (see [here](#)), which are involved in [androgen](#) synthesis. Plants lacking this protein have a growth defect, which can be reversed by brassinolide. Thus, the reductase-like protein is likely involved in the synthesis of a compound very similar (or identical) to brassinolide.

See also: [Receptors with Protein Kinase Activity](#)

INTERNET LINK: [Plant Hormones](#)

Figure 23.25: Representatives of the five major classes of plant hormones.

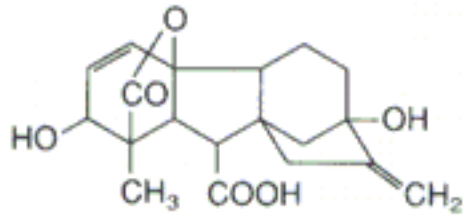

Gibberellic acid (GA3) [a gibberellin]

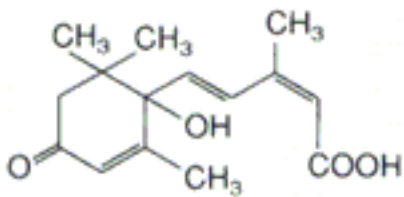

Abscisic acid (ABA)

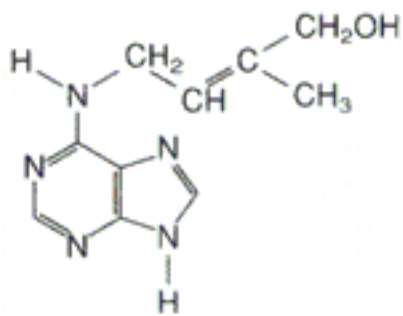

Zeatin [a cytokinin]

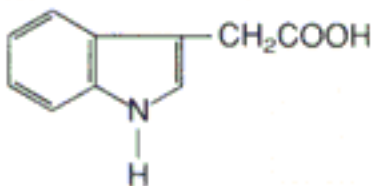

Indole-3-acetic acid (IAA) [an auxin]

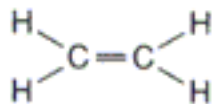

Ethylene

Abscisic Acid

The sesquiterpene **abscisic acid** is a plant hormone derived from **isopentenyl pyrophosphate**. **Abscisic acid** counteracts the effects of most other plant hormones. That is, it inhibits germination, growth, budding, and leaf senescence. Physiological evidence suggests a role for **abscisic acid** in ion and water balance.

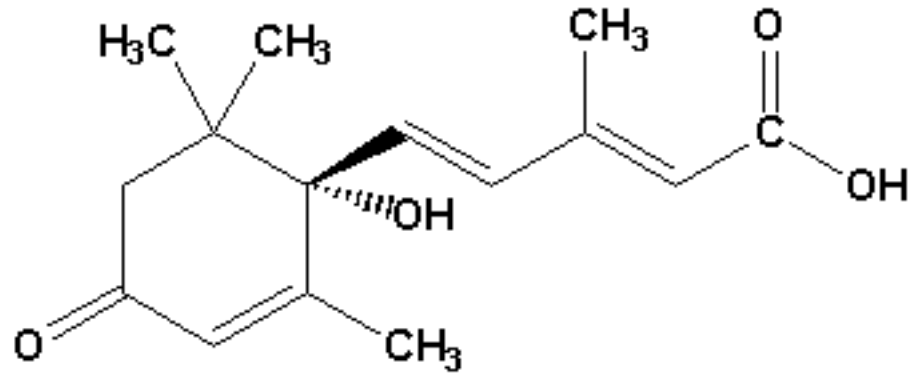

Abscisic Acid

See also: [Plant Hormones](#), [Figure 23.25](#)

INTERNET LINK: [Plant Hormones](#)

Indole-3-Acetic Acid

Indole-3-acetic acid is a plant hormone that is classified as an auxin. **Indole-3-acetic acid** is the most active auxin. Auxins are synthesized in apical buds (at the tip) of growing shoots. They stimulate growth of the main shoot and inhibit lateral shoot development. A class of auxin-binding membrane proteins may represent auxin receptors. Auxin action involves pumping protons out of the cell, possibly in conjunction with a membrane ATPase.

See also: [Plant Hormones](#), [Figure 23.25](#)

INTERNET LINK: [Plant Hormones](#)

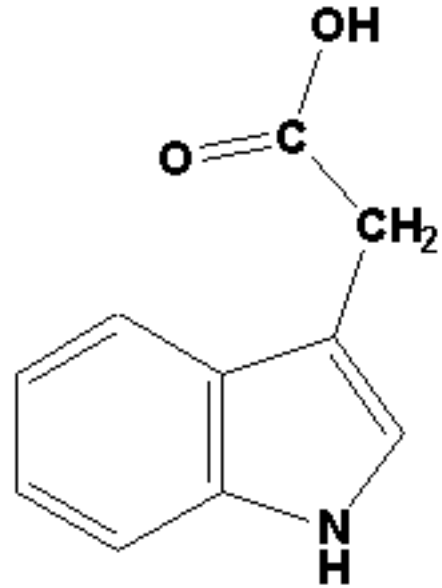

Indole-3-acetic Acid (Auxin)

Glutaminase



Glutaminase catalyzes the reaction below:

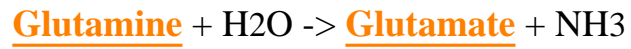

See [here](#) also

See also: [Citric Acid Cycle Intermediates in Amino Acid Metabolism](#)

Unnumbered Item

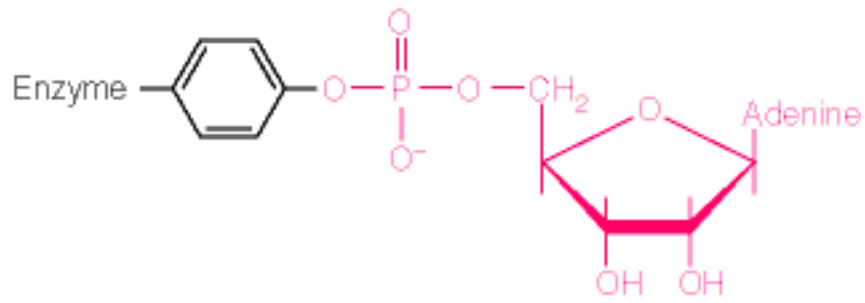

Adenylylated tyrosine residue

Figure 20.9: Regulation of the activity of E. coli glutamine synthetase.

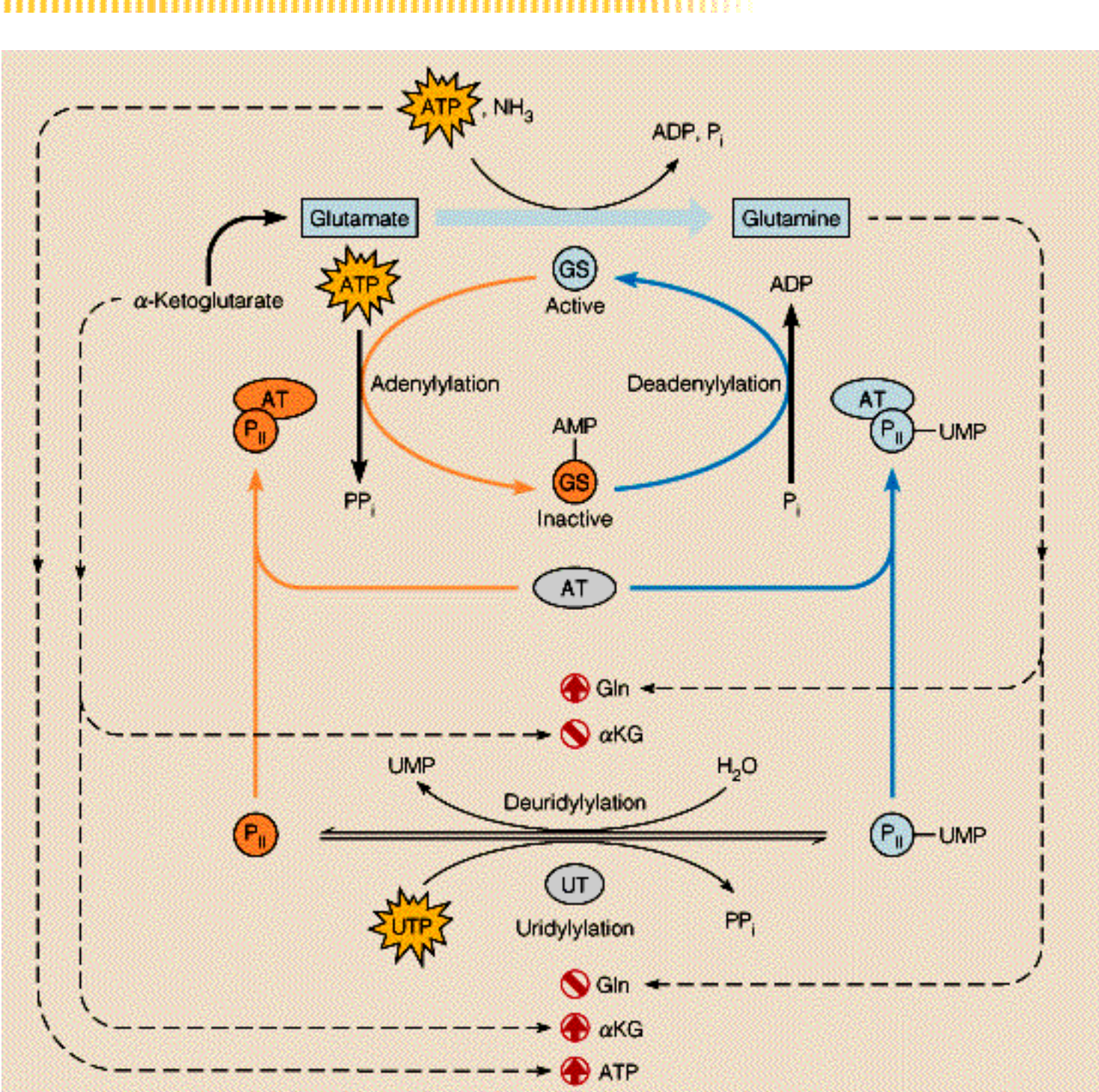

Adenylyl Transferase

The enzyme **glutamine synthetase** is regulated covalently and allosterically. The covalent modification is an adenylylation catalyzed by the enzyme **adenylyl transferase (AT)**. **AT** catalyzes the reaction in which a specific tyrosine residue in glutamine synthetase reacts with ATP to form an ester between the phenolic hydroxyl group and the phosphate of the resultant AMP. That tyrosine residue lies very close to a catalytic site. Adenylylation inactivates the adjacent catalytic site. A glutamine synthetase molecule with all 12 sites adenylylated is completely inactive, whereas partial adenylylation yields partial inactivation.

Figure 20.9 shows regulatory mechanisms of the *E. coli* glutamine synthetase. Both processes are catalyzed by the same enzyme - a complex of **adenylyl transferase (AT)** and a regulatory protein, PII. The form of PII determines whether the **AT**-PII complex catalyzes adenylylation or deadenylylation. If PII is uridylylated, the **AT**-PII complex catalyzes deadenylylation. Deuridylylation of PII causes the **AT**-PII complex to catalyze adenylylation. The enzyme uridylyl transferase catalyzes uridylylation of PII. Deuridylylation of PII is catalyzed by a different enzyme. Uridylyl transferase is allosterically regulated. ATP and α -ketoglutarate activate it. Glutamine inhibits it.

See also: [Utilization of Ammonia](#), , [Uridylyl Transferase](#)

Uridylyl Transferase

Uridylyl transferase is an enzyme that uridylylates (puts a uridyl group onto) the regulatory protein, PII (**Figure 20.9**). PII forms a complex with the enzyme, **adenylyl transferase** (AT), forming an AT-PII complex. When PII is uridylylated, the AT-PII complex catalyzes deadenylylation of **glutamine synthetase**. This, in turn, causes glutamine synthetase to become active. Conversely, when PII is deuridylylated (by a different enzyme), the AT-PII complex catalyzes deadenylylation of glutamine synthetase, inactivating it.

See also: [Utilization of Ammonia](#), ,

Carbamoyl Phosphate Synthetase

Carbamoyl phosphate synthetase is an enzyme of the [urea cycle](#) that catalyzes the following reaction:



See also: [Urea Cycle Descriptions](#), [Figure 11.35](#), [Carbamoyl Phosphate Synthetase II](#), [Utilization of Ammonia](#)

INTERNET LINK: [Urea Cycle and Metabolism of Amino Groups](#)

Biotin

Biotin is a vitamin and a coenzyme commonly associated with enzymes performing carboxylation reactions. **Biotin** is typically linked covalently to carboxylase enzymes through the ϵ -amino nitrogen of [lysine](#). **Biotin** is very tightly bound by avidin, a protein found in egg white. The strong interaction between these molecules is exploited in numerous purification techniques in biotechnology.

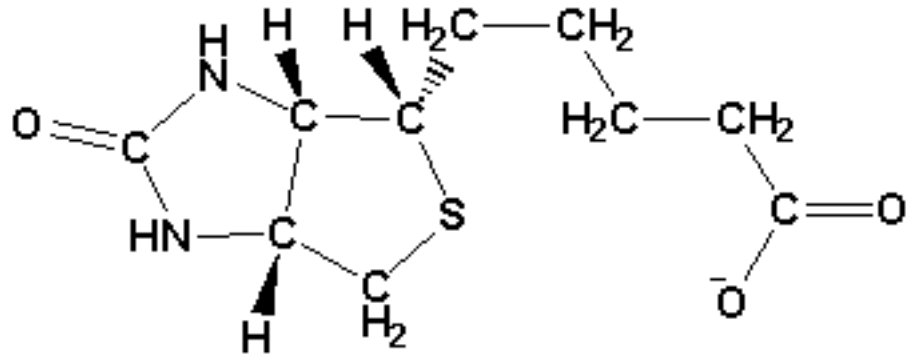

Biotin

See also: [Acetyl CoA Carboxylase](#), [Avidin](#)

Avidin



Avidin is a protein found in egg white. It binds tightly to the coenzyme, biotin. The strong interaction between these molecules is exploited in numerous purification techniques in biotechnology.

See also: [Biotin](#)

Phospholipase A2

Phospholipases are enzymes that can catalyze cleavage of acyl or phosphoacyl moieties from glycerophospholipids, as shown in [Figure 19.6](#). **Phospholipases** are implicated in rearrangement of phospholipids after they have been synthesized and in release of arachidonic acid from glycerophospholipids in eicosanoid metabolism.

Phospholipase A2 cleaves an acyl group from glycerophospholipids ([Figure 19.6](#)) and may be involved in synthesis of lung surfactant, which contains a saturated fatty acid at position 2, unlike normal glycerophospholipids, which contain an unsaturated fatty acid.

See also: [Redistribution of Phospholipid Fatty Acids](#), [Phospholipases](#), [Lung Surfactant](#), [Glycerophospholipids](#), [Second Messenger Systems](#)

Figure 19.6: Specificities of phospholipases A1, A2, C, and D.

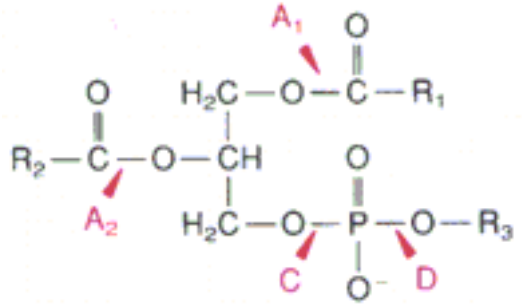

Redistribution of Phospholipid Fatty Acids

Phospholipids are not metabolic end products. The **fatty acids** within them can undergo modification even after they have been inserted into a membrane.

A prime example is the **phospholipid** component of **lung surfactant**, a lipid- and protein-containing substance that is secreted from lung and prevents collapse of the alveoli when air is expelled. Lung surfactant contains 50-60% dipalmitoylphosphatidylcholine, a saturated **glycerophospholipid**. Normally, about 90% of the fatty acids at position two for **glycerophospholipids** are unsaturated.

How does the palmitate arise at position 2 in lung surfactant? Current evidence rules out the possibility that an unsaturated fatty acid chain at position 2 is modified *in situ* to a palmitoyl chain. The two remaining possibilities are (1) direct transfer of palmitoyl chains to positions 1 and 2 of glycerophosphorylcholine and (2) hydrolytic cleavage (removal) of the unsaturated chain at position 2 followed by addition of the palmitoyl chain.

One enzyme capable of removing a fatty acid from a **glycerophospholipid** is **phospholipase A₂**, one of a class of four enzymes that hydrolyze specific bonds in phospholipids (**Figure 19.6**).

See also: [Glycerophospholipid Metabolism in Eukaryotes](#), [Posttranslational Addition of Lipids to Proteins](#),

Lung Surfactant

Lung surfactant is a lipid- and protein-containing substance that is secreted from lung and prevents collapse of the alveoli when air is expelled. Lung surfactant contains 50-60% dipalmitoylphosphatidylcholine, a saturated **glycerophospholipid**. Normally, about 90% of the fatty acids at position two for **glycerophospholipids** are unsaturated.

How does the palmitate arise at position 2 in **lung surfactant**? Current evidence rules out the possibility that an unsaturated fatty acid chain at position 2 is modified *in situ* to a palmitoyl chain. The two remaining possibilities are (1) direct transfer of palmitoyl chains to positions 1 and 2 of glycerophosphorylcholine and (2) hydrolytic cleavage (removal) of the unsaturated chain at position 2 followed by addition of the palmitoyl chain.

One enzyme capable of removing a fatty acid from a glycerophospholipid is [phospholipase A2](#), one of a class of four enzymes that hydrolyze specific bonds in phospholipids ([Figure 19.6](#)).

See also: [Redistribution of Phospholipid Fatty Acids](#), [Glycerophospholipids](#), [Phospholipases](#),

INTERNET LINKS

1. [Glycerolipid Metabolism](#)
 2. [Phospholipid Catabolism](#)
 3. [American Lung Association](#)
-

Phospholipases

Phospholipid fatty acids may be redistributed after they are synthesized in response to varying environmental conditions or needs.

Phospholipases are enzymes that can catalyze cleavage of acyl or phosphoacyl moieties from glycerophospholipids, as shown in [Figure 19.6](#). **Phospholipases** are implicated in rearrangement of phospholipids after they have been synthesized and in release of [arachidonic acid](#) from glycerophospholipids in [eicosanoid](#) metabolism.

See also: [Redistribution of Phospholipid Fatty Acids](#), [Phospholipase A2](#), [Lung Surfactant](#), [Glycerophospholipids](#)

Posttranslational Addition of Lipids to Proteins

Linking a lipid to a protein helps to provide an "anchor" for the protein inside of the lipid bilayer of cellular membranes. Examples include the following:

1. Acylation - transfer of single saturated acyl groups. These are primarily myristate (C14) linked as an amide to N-terminal glycine and palmitate (C16) linked as a thioester to cysteine. A large number of viral proteins, membrane proteins, and proteins involved in signal transduction are acylated in this manner.

2. Prenylation - transfer of C15 or C20 groups from intermediates in cholesterol biosynthesis to cysteine residues four positions from the C-terminus of the protein. ([Figure 19.10](#)).

3. Esterification to cholesterol - recently the "hedgehog" family of proteins regulating differentiation has been shown to be esterified with cholesterol near the C terminus. Signaling by hedgehog proteins in development plays a significant role in defining the polarity (orientation) of many tissue types in vertebrate and invertebrate organisms.

4. Linkage of a cell surface protein to a glycosylated form of phosphatidylinositol. [Figure 19.9](#) shows a proposed mechanism by which this may occur.

See also: [Biosynthesis of Cholesterol](#), [Cholesterol](#), [Phosphatidylinositol](#)

INTERNET LINKS:

1. [Health News \(Cholesterol and Hedgehog Protein\)](#)

Figure 19.10: The protein farnesyltransferase reaction.

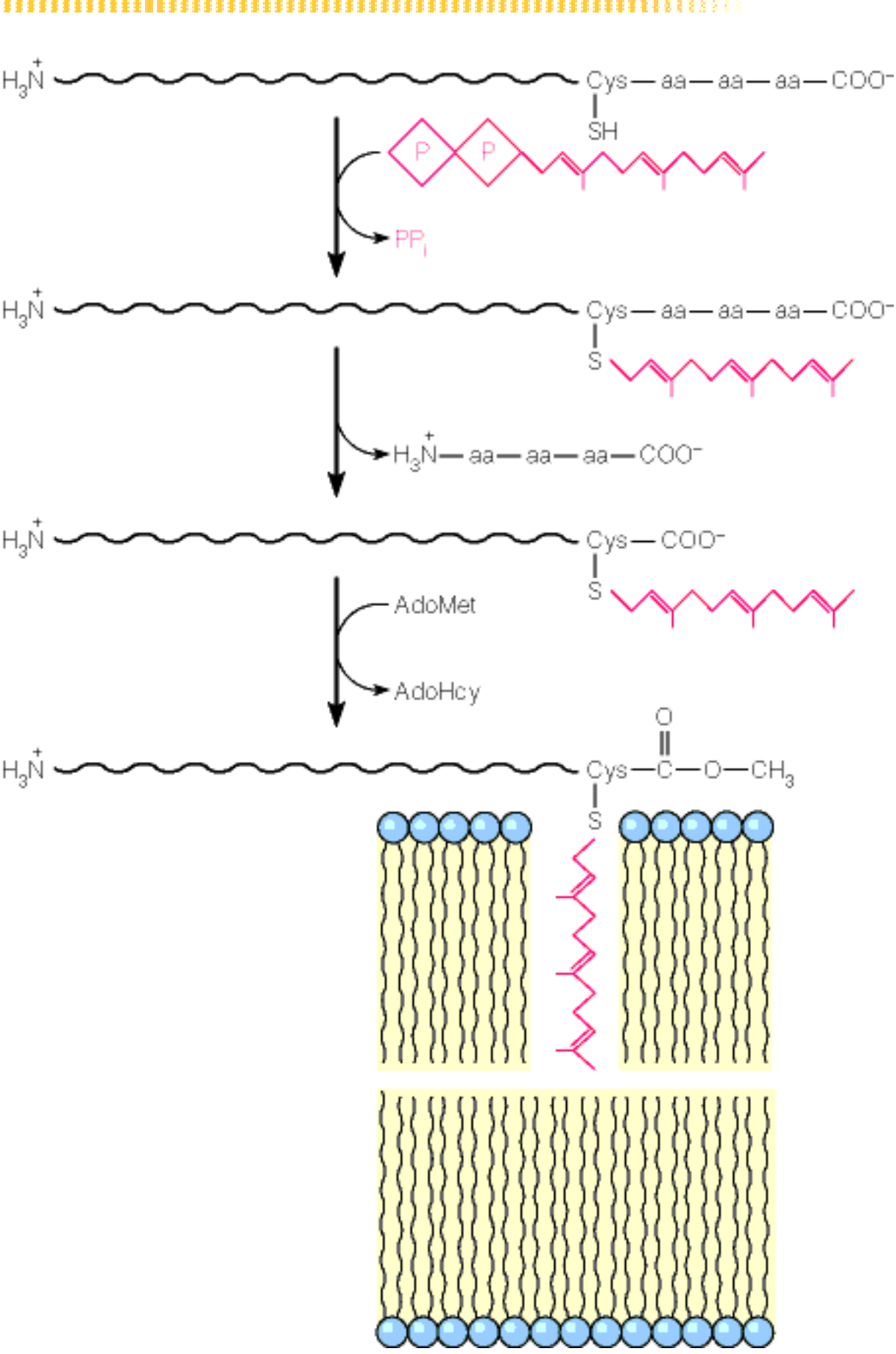
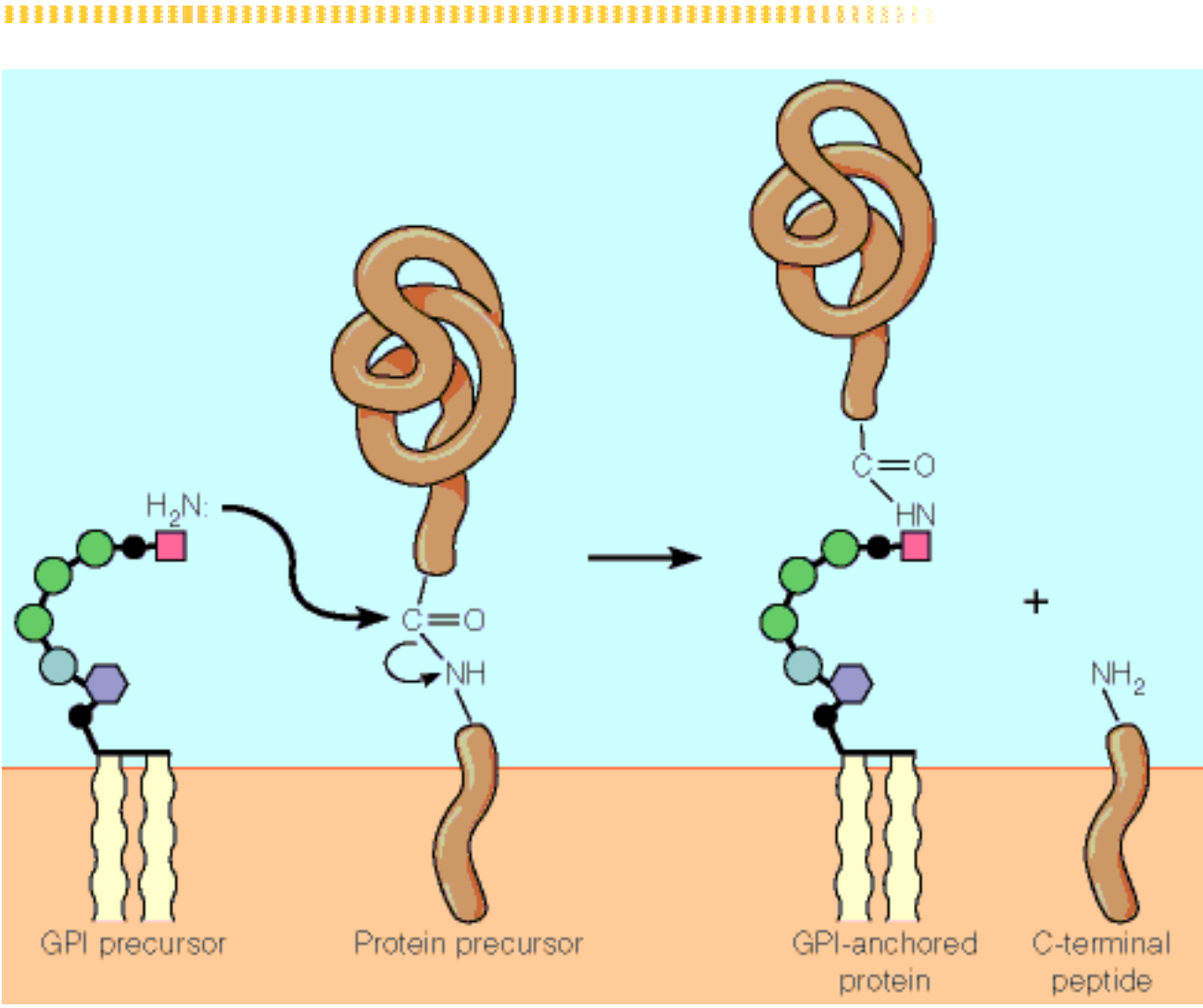

Figure 19.9: Anchoring of proteins in membranes by a glycolipid containing phosphatidylinositol.



Courtesy of T. L. Doering, W. J. Masterson, G. W. Hart, and P. T. Englund, *J. Biol. Chem.* (1990) 265:611-614, reprinted by permission of The American Society for Biochemistry & Molecular Biology.

Prostaglandin H (PGH) Synthase

PGH synthase is the enzyme that converts arachidonic acid to PGH₂, the precursor of the other prostaglandins ([Figure 19.31](#)). The reaction mechanism by which PGH synthase works is shown in [Figure 19.32](#).

Mammalian cells contain two forms of **PGH synthase** called **PGHS-1** and **PGHS-2** (or **Cox-1** and **Cox-2**, respectively). This enzyme catalyzes the conversion of [arachidonic acid](#) to [PGH₂](#), an essential step in [prostaglandin biosynthesis](#).

Aspirin and other non-steroidal compounds, which target the **PGH synthases**, are called non-steroidal anti-inflammatory drugs ([NSAIDs](#)) because they help prevent formation of prostaglandins and thromboxanes, thus reducing pain and inflammation in the body.

See also: [Eicosanoids](#), [Phospholipases](#), [Phosphatidylcholine](#), [Phosphatidylethanolamine](#), [Phosphatidylinositol](#), [PGH Synthase](#), , [Ibuprofen](#)

INTERNET LINKS:

1. [Eicosanoids](#)
 2. [Prostaglandin and Leukotriene Metabolism](#)
-

Figure 19.31: Probable mechanism for the cyclooxygenation of arachidonic acid by PGH synthase.

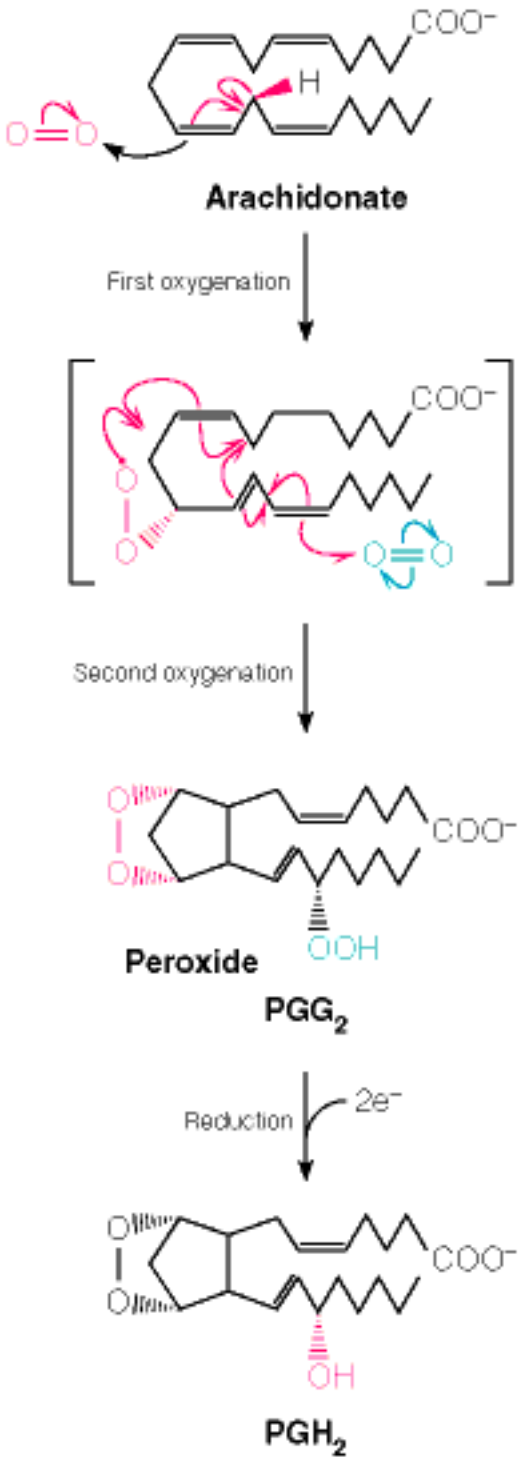

Prostaglandin H2 (PGH2)

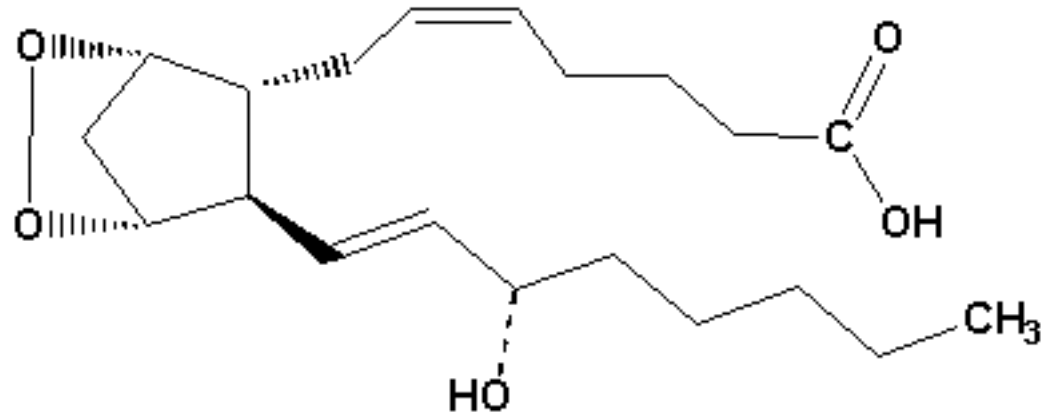

Prostaglandin H2 (PGH2)

See also: [Eicosanoids](#), [Prostaglandin Biosynthesis](#), [Prostaglandins](#)

INTERNET LINK: [Prostaglandin and Leukotriene Metabolism](#)

NSAIDs

The enzyme **PGH synthase** catalyzes the conversion of **arachidonic acid** to PGH₂, an essential step in prostaglandin biosynthesis. Mammalian cells contain two forms of **PGH synthase** called PGHS-1 and PGHS-2 (or Cox-1 and Cox-2, respectively).

Aspirin and other non-steroidal compounds, which target the PGH synthases, are called non-steroidal **anti-inflammatory drugs (NSAIDs)** because they help prevent formation of prostaglandins and thromboxanes, thus reducing pain and inflammation in the body.

Aspirin (acetylsalicylic acid) acts to inhibit both PGHS-1 and PGHS-2 by acetylating a specific **serine** residue in each enzyme, blocking access of arachidonate to the active site. The antiinflammatory and analgesic properties of aspirin arise from inhibition of PGHS-2. Inhibition of PGHS-1 leads to ulceration and other undesirable effects on the gastrointestinal system.

Ibuprofen acts more specifically on PGSH-2, but is less effective of an inhibitor than aspirin.

A new **NSAID** called Celebrex was released in 1998 for relief of arthritis pain. It binds 400-fold more tightly to PGHS-2 than to PGHS-1 so it should maximize the antiinflammatory and analgesic benefits while minimizing the undesirable effects.

See also: [Eicosanoids](#), [Prostaglandin Biosynthesis](#), [Prostaglandins](#), [Thromboxanes](#)

INTERNET LINK: [COX-2 Inhibitors](#)

Ibuprofen

Ibuprofen is a non-steroidal anti-inflammatory (NSAID) drug that acts by inhibiting **PGH synthase 2**.

See also: [Eicosanoids](#), [Prostaglandin Biosynthesis](#), [Prostaglandins](#), [Thromboxanes](#), [NSAIDS](#)

INTERNET LINK: [COX-2 Inhibitors](#)

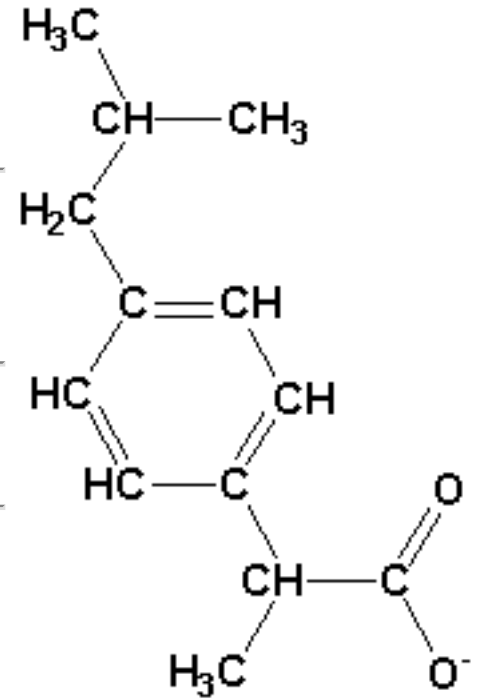

Ibuprofen

Linoleic Acid

Linoleic acid is an unsaturated fatty acid that is an essential fatty acid in mammals because they cannot synthesize double bonds in fatty acids beyond position #9.

Linoleic acid and linolenic acid are thus essential in mammalian diets, since they have double bonds beyond position #9 (at positions 9,12 and at positions 9,12, and 15 for linoleic and linolenic acid, respectively).

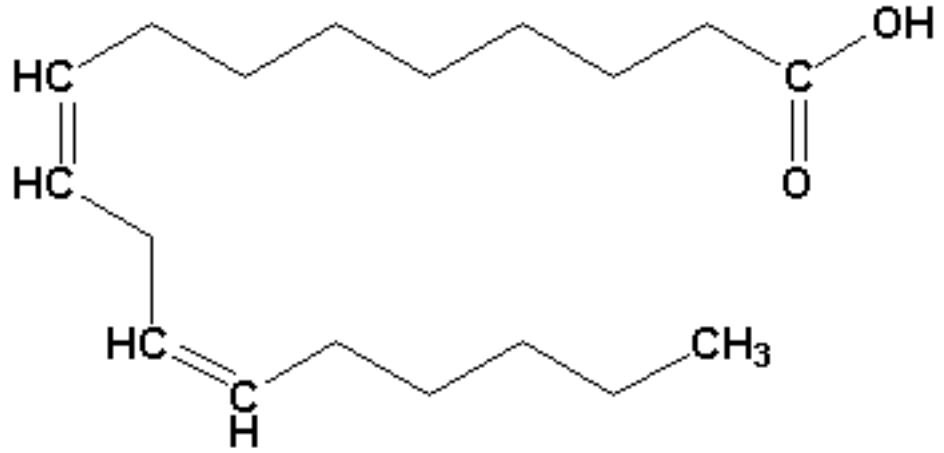

Linoleic Acid

Linoleic acid is an important precursor of arachidonic acid ([Figure 18.33](#)), which is itself a precursor of the eicosanoids, a class that includes the prostaglandins and leukotrienes.

See also: [Arachidonic Acid](#), [Essential Fatty Acids](#), [Fatty Acids](#), [Eicosanoids](#)

INTERNET LINK: [Prostaglandin and Leukotriene Metabolism](#)

Essential Fatty Acids

Mammals cannot synthesize unsaturated fatty acids having double bonds further than 9 carbons from the carboxyl group. Thus, mammals can synthesize oleic acid and palmitoleic acid (double bonds at carbon 9), but not linoleic acid (double bonds at carbons 9 and 12) or linolenic acid (double bonds at carbons 9, 12, and 15). As a result, fatty acids such as linoleic acid and linolenic acid are called '**essential**' **fatty acids** because they must be present in the diet. [Figure 18.33](#) shows how linoleic acid is converted to arachidonic acid, an important precursor to the prostaglandins and thromboxanes.

See also: [Linoleic Acid](#), [Linolenic Acid](#), [Arachidonic Acid](#), [Fatty Acid Desaturation](#)

Linolenic Acid

Linolenic acid is an unsaturated fatty acid that is an **essential fatty acid** in mammals because they cannot synthesize double bonds in fatty acids beyond position #9. This makes linoleic acid and **linolenic acid** essential in mammalian diets, since they have double bonds beyond position #9 (at positions 9,12 and at positions 9,12, and 15 for linoleic and linolenic acid, respectively).

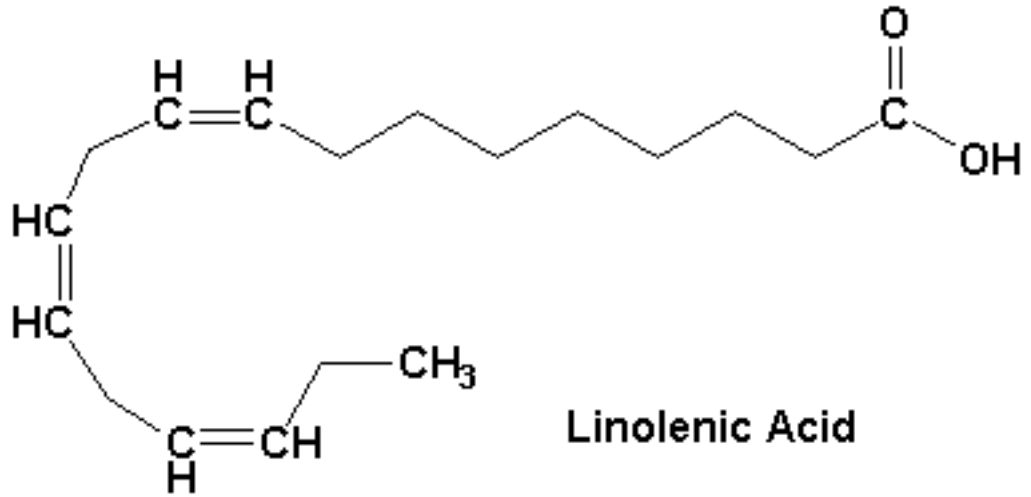

See also: [Fatty Acid Desaturation](#), , [Fatty Acids](#), [Linoleic Acid](#)

Fatty Acid Desaturation

In animals, **desaturation** of fatty acids requires a **fatty acyl-CoA desaturase** (**Figure 18.32**). The enzyme that creates oleic acid and palmitoleic acid from stearate and palmitate, respectively, is called a Δ -9 enzyme, because it creates a double bond nine carbons from the carboxyl group of the fatty acids. Similar enzymes in mammalian systems include Δ 5 and Δ 6 **desaturases**, which are under complex hormonal control.

Mammals cannot synthesize double bonds in fatty acids beyond the ninth carbon, so linoleic acid (double bonds at carbons 9 and 12) and **linolenic Acid** (double bonds at carbons 9,12, and 15) must be provided in mammalian diets.

Linoleic acid is an important precursor of **arachidonic acid** (**Figure 18.33**), which is itself a precursor of the **prostaglandins** and thromboxanes.

See also: **Essential Fatty Acids**,

INTERNET LINKS:

1. **Fatty Acid Metabolism**
 2. **Prostaglandin and Leukotriene Metabolism**
-

Fatty Acyl-CoA Desaturase



Fatty acyl-CoA desaturase is an animal enzyme that catalyzes *cis* bond formation in [stearic acid](#) (to form [oleic acid](#)) and [palmitic acid](#) (to form [palmitoleic acid](#)). The unusual reaction scheme is depicted in [Figure 18.32](#).

See also: [Fatty Acid Desaturation](#), [Essential Fatty Acids](#)

Stearic Acid (Stearate)

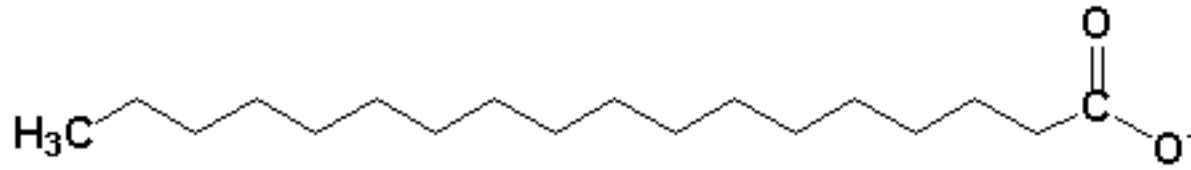

Stearate

Stearic acid is a 16-carbon saturated fatty acid that is a precursor of the unsaturated fatty acid, [oleic acid](#).

See also: [Fatty Acids](#), [Table 10.1](#), [Synthesis of Long Chain Fatty Acids](#), [Fatty Acid Desaturation](#), [Fatty Acid Synthase](#), [Palmitate Synthesis from Acetyl-CoA](#), [Fatty Acyl-CoA Desaturase](#)

Oleic Acid (Oleate)

Oleic acid is an 18-carbon fatty acid with a single double bond derived from the saturated fatty acid, stearic acid.

See also: Fatty Acids, Table 10.1, Synthesis of Long Chain Fatty Acids, Fatty Acid Desaturation, Fatty Acid Synthase, Palmitate Synthesis from Acetyl-CoA, Fatty Acyl-CoA Desaturase

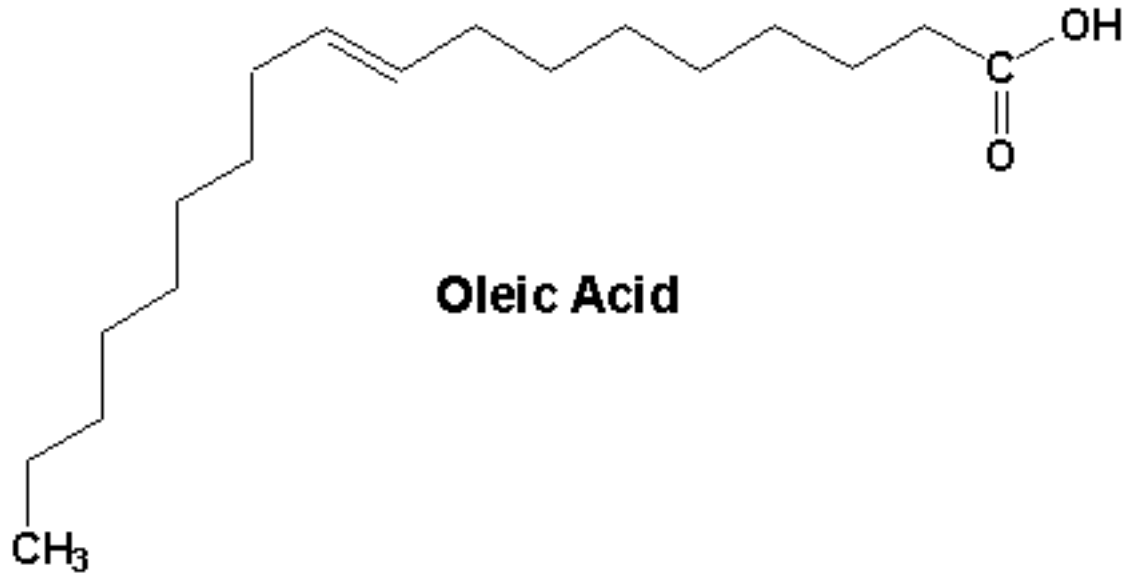

Table 10.1

Common Name	Systematic Name	Abbreviation	Structure	Melting Point (°C)
Saturated Fatty Acids				
Capric	<i>n</i> -Decanoic	10:0	$\text{CH}_3(\text{CH}_2)_8\text{COOH}$	31.6
Lauric	<i>n</i> -Dodecanoic	12:0	$\text{CH}_3(\text{CH}_2)_{10}\text{COOH}$	44.2
Myristic	<i>n</i> -Tetradecanoic	14:0	$\text{CH}_3(\text{CH}_2)_{12}\text{COOH}$	53.9
Palmitic	<i>n</i> -Hexadecanoic	16:0	$\text{CH}_3(\text{CH}_2)_{14}\text{COOH}$	63.1
Stearic	<i>n</i> -Octadecanoic	18:0	$\text{CH}_3(\text{CH}_2)_{16}\text{COOH}$	69.6
Arachidic	<i>n</i> -Eicosanoic	20:0	$\text{CH}_3(\text{CH}_2)_{18}\text{COOH}$	76.5
Behenic	<i>n</i> -Docosanoic	22:0	$\text{CH}_3(\text{CH}_2)_{20}\text{COOH}$	81.5
Lignoceric	<i>n</i> -Tetracosanoic	24:0	$\text{CH}_3(\text{CH}_2)_{22}\text{COOH}$	86.0
Cerotic	<i>n</i> -Hexacosanoic	26:0	$\text{CH}_3(\text{CH}_2)_{24}\text{COOH}$	88.5
Unsaturated Fatty Acids				
Palmitoleic	<i>cis</i> -9-Hexadecenoic	16:1 Δ 9	$\text{CH}_3(\text{CH}_2)_5\text{CH}=\text{CH}(\text{CH}_2)_7\text{COOH}$	0
Oleic	<i>cis</i> -9-Octadecenoic	18:1 Δ 9	$\text{CH}_3(\text{CH}_2)_7\text{CH}=\text{CH}(\text{CH}_2)_7\text{COOH}$	16
Linoleic	<i>cis,cis</i> -9,12-Octadecadienoic	18:2 Δ 9,12	$\text{CH}_3(\text{CH}_2)_4\text{CH}=\text{CHCH}_2\text{CH}=\text{CH}(\text{CH}_2)_7\text{COOH}$	5
Linolenic	all- <i>cis</i> -9,12,15-Octadecatrienoic	18:3 Δ 9,12,15	$\text{CH}_3\text{CH}_2\text{CH}=\text{CHCH}_2\text{CH}=\text{CHCH}_2\text{CH}=\text{CH}(\text{CH}_2)_7\text{COOH}$	-11
Arachidonic	all- <i>cis</i> -5,8,11,14-Eicosatetraenoic	20:4 Δ 5,8,11,14	$\text{CH}_3(\text{CH}_2)_4\text{CH}=\text{CHCH}_2\text{CH}=\text{CHCH}_2\text{CH}=\text{CHCH}_2\text{CH}=\text{CH}(\text{CH}_2)_3\text{COOH}$	-50
Branched and Cyclic Acids				
Tuberculostearic	<i>I</i> -D-10-Methyloctadecanoic		$\text{CH}_3(\text{CH}_2)_7\overset{\text{CH}_3}{\underset{ }{\text{C}}}\text{H}(\text{CH}_2)_8\text{COOH}$	13.2
Lactobacillic	ω -(2- <i>n</i> -Octylcyclopropyl)-octadecanoic		$\text{CH}_3(\text{CH}_2)_5\text{CH}-\overset{\text{CH}_2}{\underset{\diagdown}{\text{C}}}\text{H}(\text{CH}_2)_9\text{COOH}$	29

Palmitoleic Acid

Palmitoleic acid is an 16-carbon fatty acid with a single double bond derived from the saturated fatty acid, **palmitic acid**.

See also: [Fatty Acids](#), [Table 10.1](#), [Synthesis of Long Chain Fatty Acids](#), [Fatty Acid Desaturation](#), [Fatty Acid Synthase](#), [Palmitate Synthesis from Acetyl-CoA](#), [Fatty Acyl-CoA Desaturase](#)

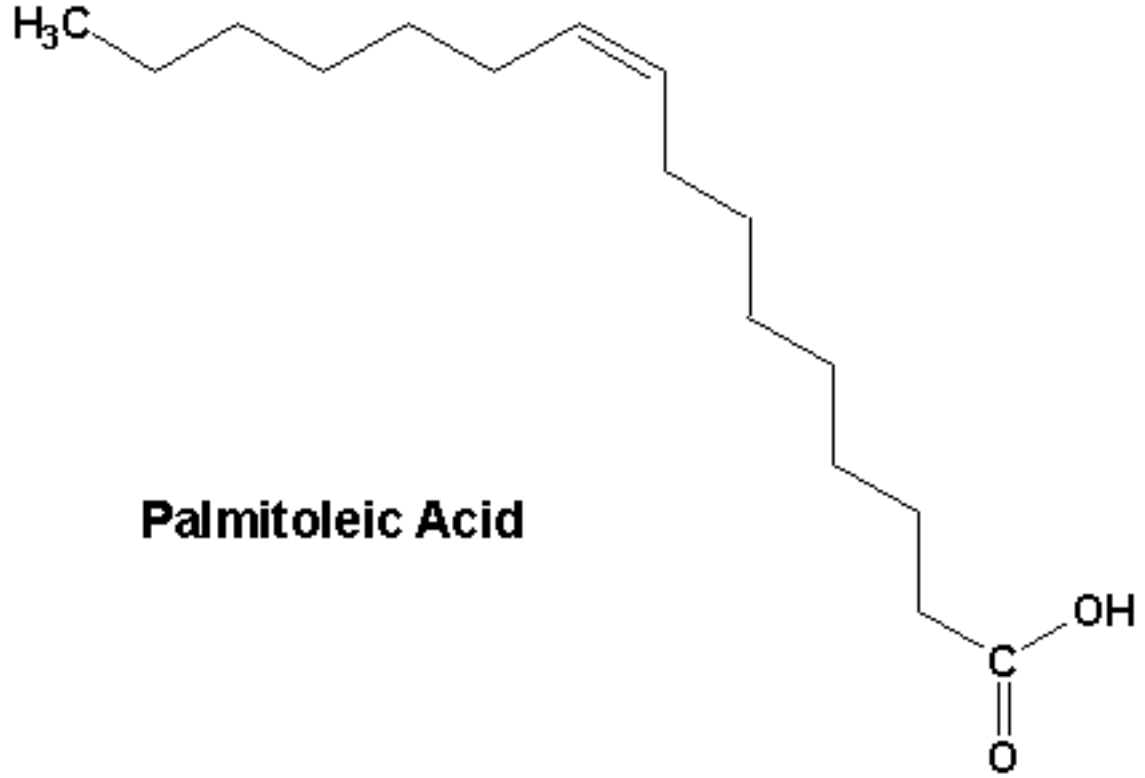
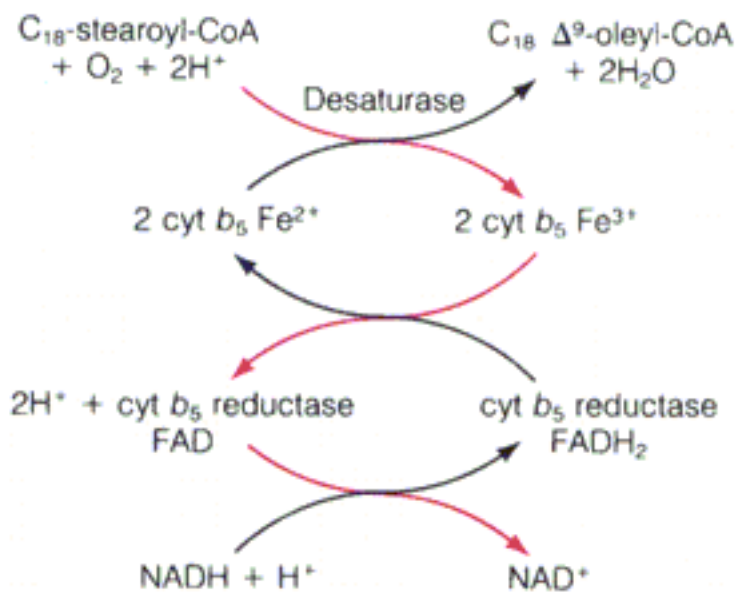
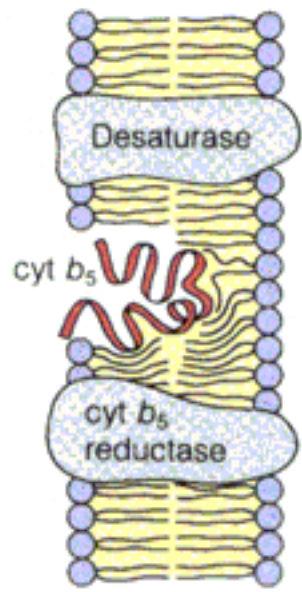

Figure 18.32: Fatty acid desaturation system.



(a)



(b)

Prostaglandin F2 (PGF2)

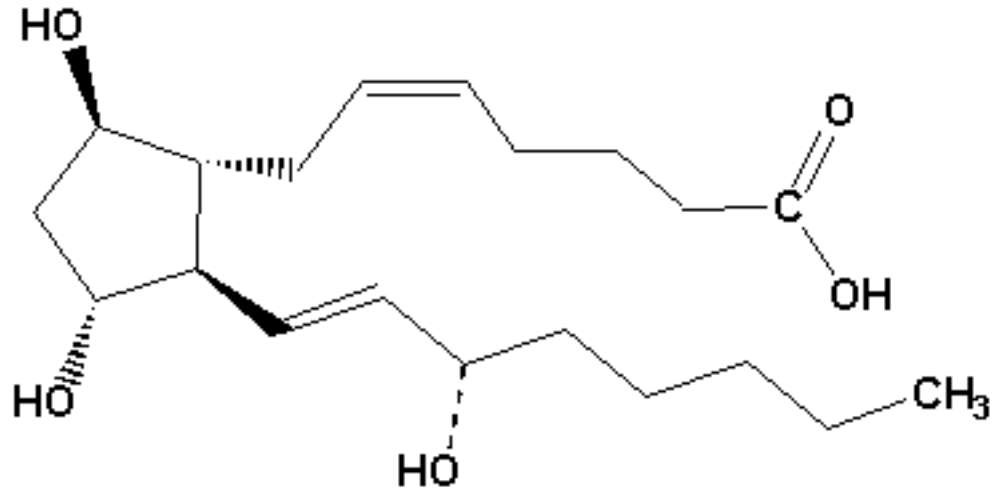

Prostaglandin F2 (PGF2)

See also: [Eicosanoids](#), [Prostaglandin Biosynthesis](#), [Prostaglandins](#)

INTERNET LINK: [Prostaglandin and Leukotriene Metabolism](#)

Thromboxane B

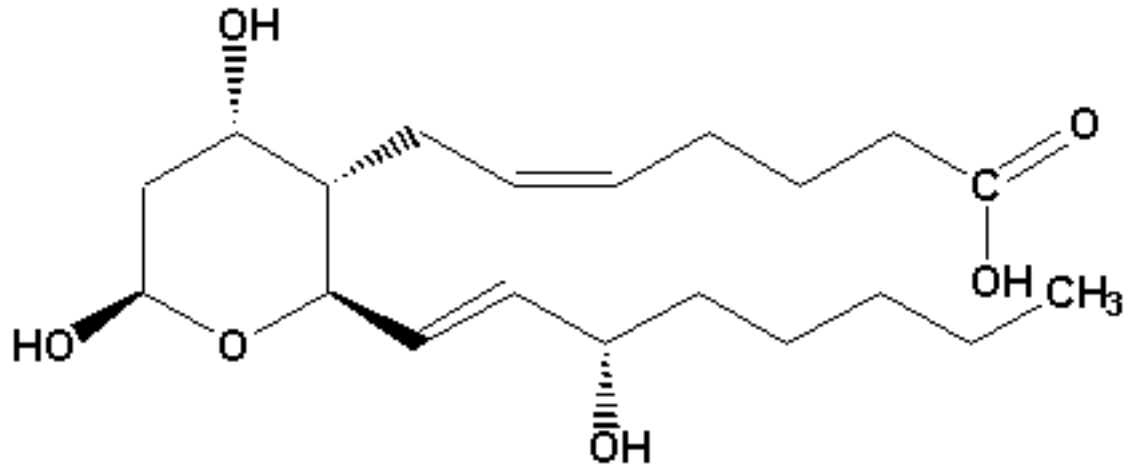

Thromboxane B2 (TxB2)

See also: [Eicosanoid Functions](#), [Eicosanoids](#), [Prostaglandin Biosynthesis](#), [NSAIDs](#), [Thromboxane B2](#)

INTERNET LINKS:

1. [Eicosanoids](#)
 2. [Prostaglandin and Leukotriene Metabolism](#)
-

Prostaglandin E2 (PGE2)

PGF_{2α} and **PGE₂** are used to induce abortion in the second trimester or to induce delivery in case of the death of a fetus.

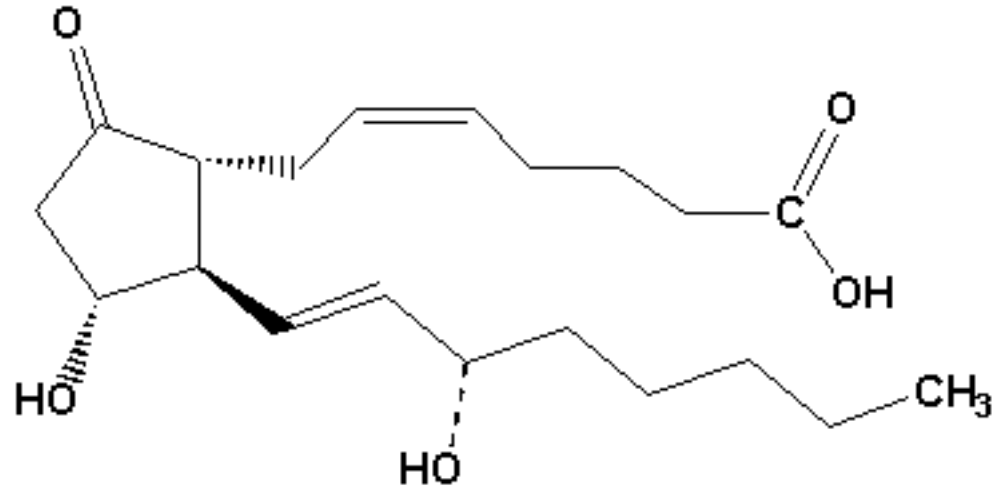

Prostaglandin E2 (PGE2)

See also: [Eicosanoids](#), [Prostaglandin Biosynthesis](#), [Prostaglandins](#)

INTERNET LINK: [Prostaglandin and Leukotriene Metabolism](#)

Prostaglandin I₂ (PGI₂)

PGI₂ is used to reduce the risk of blood clotting during cardiopulmonary bypass operations.

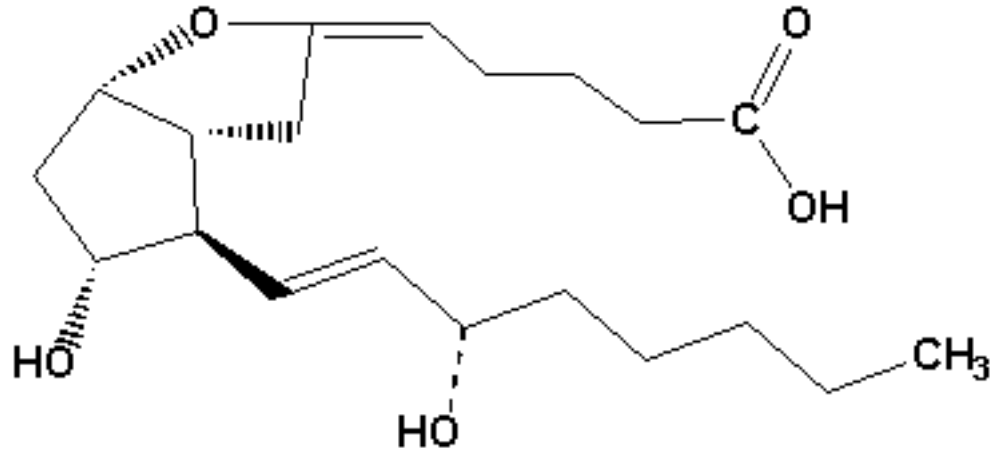

Prostaglandin I₂ (PGI₂)

See also: [Eicosanoids](#), [Prostaglandin Biosynthesis](#), [Prostaglandins](#)

INTERNET LINK: [Prostaglandin and Leukotriene Metabolism](#)

Prostaglandin A (PGA)

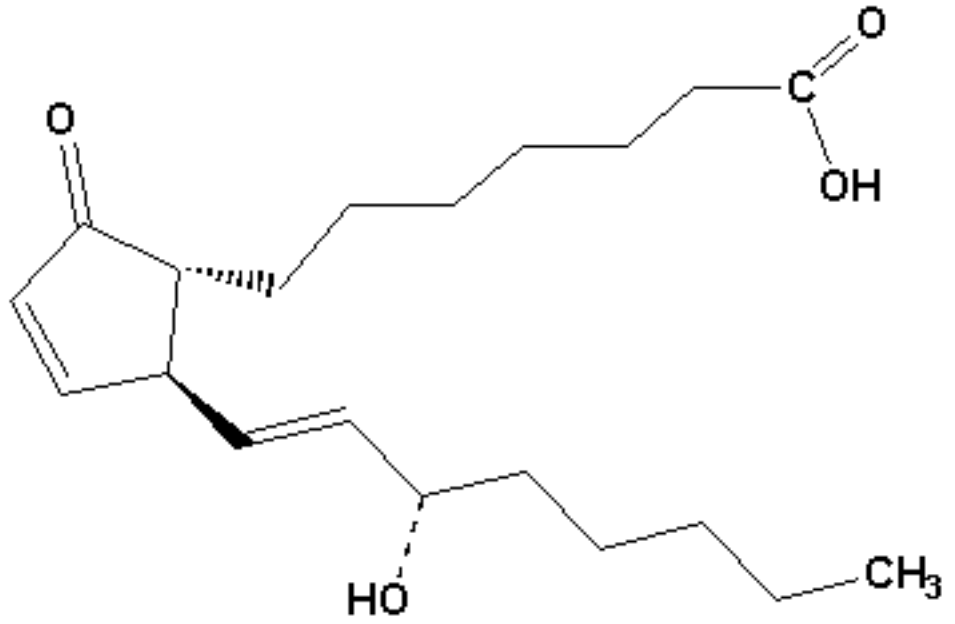

Prostaglandin A (PGA)

See also: [Eicosanoids](#), [Prostaglandin Biosynthesis](#), [Prostaglandins](#)

INTERNET LINK: [Prostaglandin and Leukotriene Metabolism](#)

Prostaglandin F (PGF)

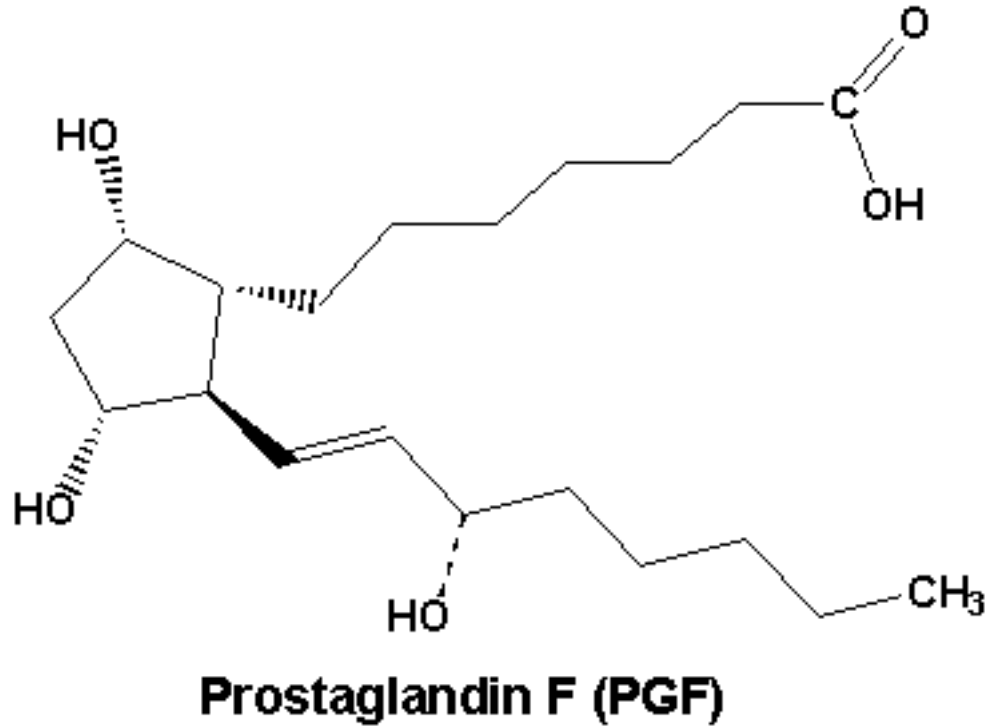

See also: [Eicosanoids](#), [Prostaglandin Biosynthesis](#), [Prostaglandins](#)

INTERNET LINK: [Prostaglandin and Leukotriene Metabolism](#)

Prostaglandin H (PGH)

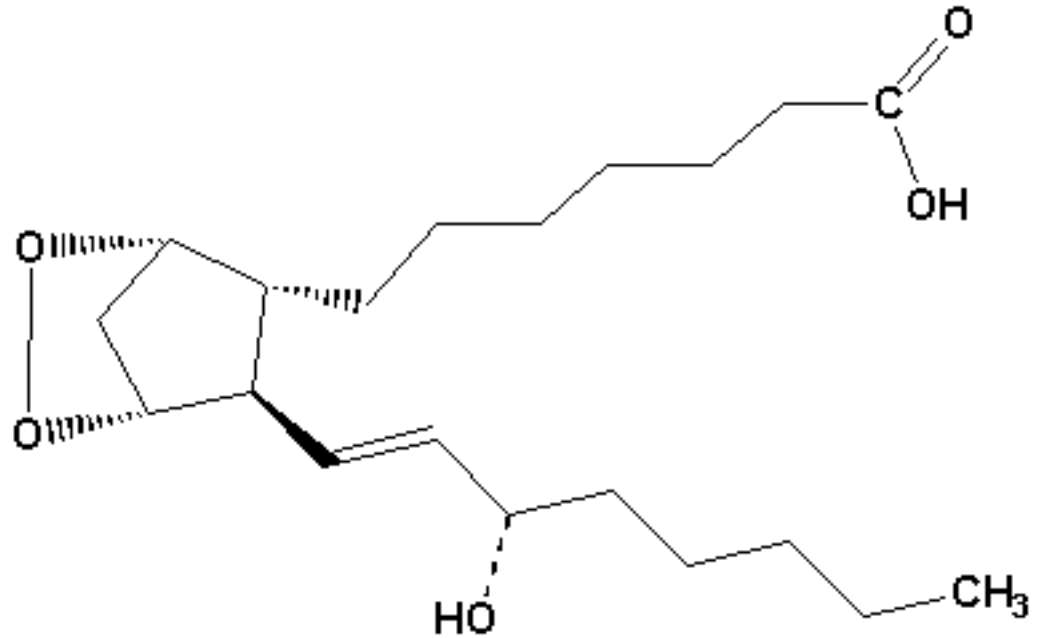

Prostaglandin H (PGH)

See also: [Eicosanoids](#), [Prostaglandin Biosynthesis](#), [Prostaglandins](#)

INTERNET LINK: [Prostaglandin and Leukotriene Metabolism](#)

Elongation of Translation

Translation occurs in three distinct stages--initiation, **elongation**, and termination. Each step requires specific proteins that interact with the **tRNAs**, **mRNA**, and/or **ribosomes**. Some of these are listed in **Table 27.4**.

Three tRNA binding sites on the 70S ribosome are involved in the process of **elongation**. **Figure 27.22** shows a single round of this cycle, which is repeated until a signal for termination is encountered. The cycle goes as follows:

1. The nascent polypeptide chain is attached to a tRNA in the P site and the A and E sites are empty. Aligned with the A site is the mRNA codon corresponding to the next amino acid to be incorporated.
2. A charged tRNA is escorted to the A site in a complex with the protein **elongation factor** EF-Tu, which also carries a molecule of **GTP**.
3. When the appropriate charged tRNA is deposited into the A site, the GTP is hydrolyzed and the EF-Tu-GDP is released. EF-Tu-GTP is regenerated, as shown in **Figure 27.20**. Proofreading occurs at this step after the charged tRNA is in place. The charged tRNA is checked both before and after the GTP hydrolysis and is rejected if incorrect.
4. Peptide bond formation - The polypeptide chain that was attached to the tRNA in the P site is transferred to the amino group of the amino acid carried by the A-site tRNA. This step is called peptidyl transfer and is catalyzed by an enzyme complex called peptidyltransferase, which is an integral part of the 50S subunit. Peptidyltransferase consists of some ribosomal proteins and the ribosomal RNA, which acts as a **ribozyme**.
5. Translocation - The uncharged tRNA remaining in the P site is transferred to the E site and the tRNA in a hybrid P/A state (that has the nascent polypeptide chain attached to it) is moved to the P site. At the same time, the ribosome moves the mRNA by three nucleotides in the 3' direction, placing a new codon adjacent to the now empty A site. This step requires the protein factor EF-G bound to GTP; GTP is hydrolyzed in the process. EF-G-GTP has a remarkable molecular similarity to the tRNA^{aminoacid}-EF-Tu-GTP complex and may act to displace the bound tRNA.
6. As the old tRNA is released from the E site, the empty A site accepts the aminoacyl tRNA corresponding to the next codon.

The net result of one turn of this cycle is that the polypeptide has grown by one amino acid residue and the ribosome has moved along the mRNA by three nucleotide residues. The process is repeated until a termination signal is reached. [Figure 27.25](#) shows that as the polypeptide chain elongates, it passes through a tunnel in the 50S subunit and emerges from a hole near the bottom.

See also: [Initiation of Translation](#), [Structure of tRNAs](#), [Structure of Prokaryotic mRNAs](#), [Termination of Translation](#), [Eukaryotic vs Prokaryotic Translation](#) (from Chapter 28)

INTERNET LINK: [Translation Initiation and Elongation Factors](#)

Table 27.4



Factor	Approximate Number per Ribosome in Cell	Binds GTP?	Role
Initiation			
IF1	1/7	No	Promotes dissociation of 70S ribosome
IF2	1/7	Yes	Helps attach initiator tRNA
IF3	1/7	No	Similar to IF1
Elongation			
EF-Tu	~10	Yes	Carries tRNA into A site
EF-Ts	1	Yes	Participates in recharging EF-Tu with GTP
EF-G	1	Yes	Facilitates translocation
Termination			
RF1	1/20	No	Release factor (UAA, UAG)
RF2	1/20	No	Release factor (UAA, UGA)
RF3	?	Yes	A GTPase that promotes release

Figure 27.22: Chain elongation in prokaryotic translation.

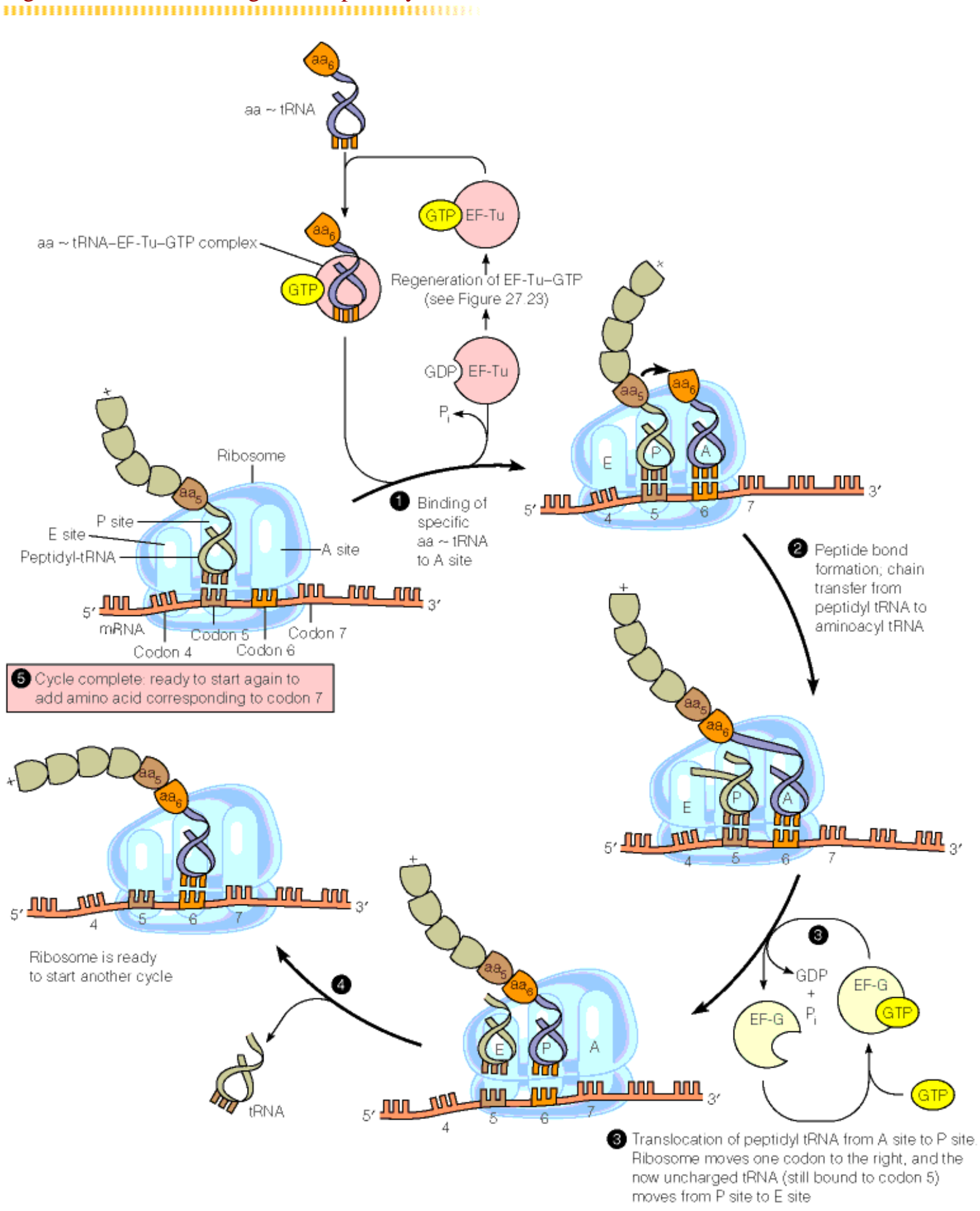

ribosome moves one codon to the right, and the
now uncharged tRNA (still bound to codon 5)
moves from P site to E site

Figure 27.23: Regeneration of EF-Tu-GTP by Tu-Ts exchange.

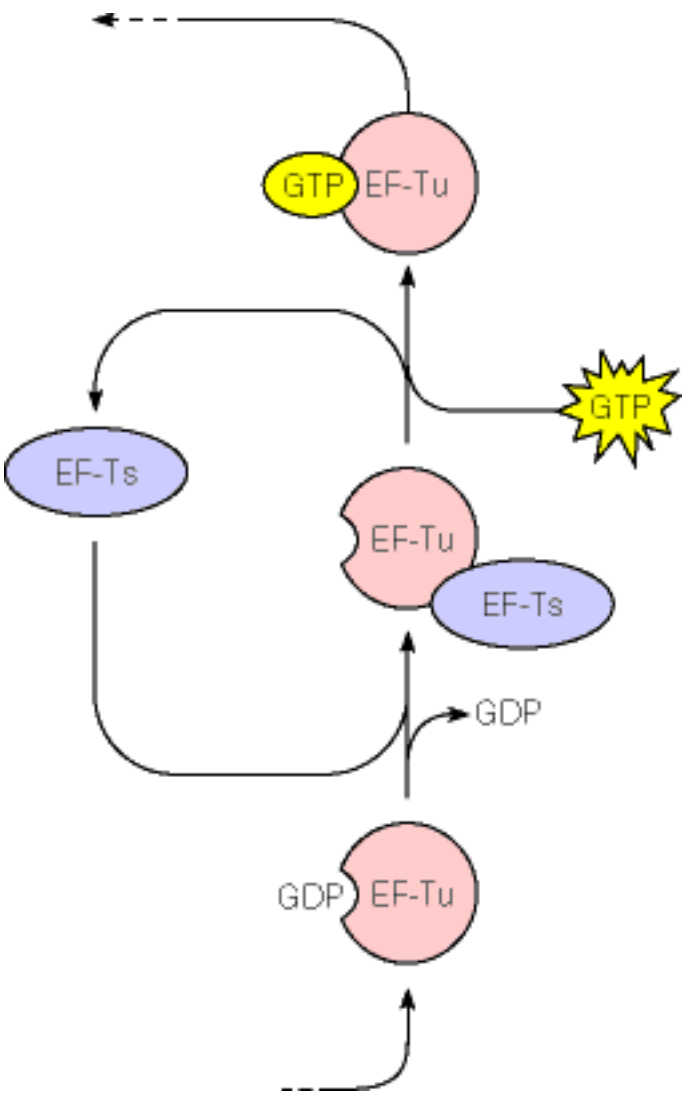

Ribozymes

In most cases, proteins called enzymes (or abzymes-see [here](#)) catalyze chemical reactions. It turns out, however, that some RNA molecules, called **ribozymes** are capable of catalyzing chemical reactions too. [Figure 11.29](#) shows the site of action of the RNA-protein complex called ribonuclease P. The RNA portion of the complex can, by itself, catalyze the hydrolysis of the specific bond indicated by the red wedge in the figure.

Tom Cech identified an interesting protein-independent self-splicing agent from the preribosomal RNA of the protist, *Tetrahymena*. In this reaction, the rRNA itself catalyzes removal of an RNA intron from itself. The RNA molecule involved in the catalysis is altered, so it is not technically considered a catalyst, but the sequence which is removed (called L-19 IVS) does have true catalytic activity. It can either lengthen or shorten small oligonucleotides, in the manner shown in [Figure 11.30](#).

RNAs can catalyze reactions in which evolution of more efficient molecules based on selection can occur. Such processes may have been of importance in a pre-protein world during the origin of life.

See also: [RNA](#)

INTERNET LINKS:

1. [Ribozyme Enzymology](#)
-

Molecular Engineering

Molecular engineering is a term loosely used to describe the design of enzymes using modern molecular biological techniques to alter their catalytic action. Examples include the following:

Site-directed mutagenesis - In this technique, the DNA coding sequence for an enzyme is altered to change one or more amino acids in an enzyme when the mutated DNA is expressed in an organism.

Hybrid enzymes - Here, molecular techniques allow researchers to put together two different biomolecules to make a fusion molecule with new, useful properties. [Figure 11.28](#) depicts a hybrid enzyme made in this fashion. In this case, an oligonucleotide of a defined sequence has been grafted onto the enzyme staphylococcal nuclease. The specific sequence in the hybrid enzyme allows it to bind to a specific complementary nucleic acid sequence (specified by the bound oligonucleotide) and cut specifically at that point. The native, unaltered enzyme has no such specificity.

Catalytic antibodies - These interesting molecules are antibodies with a very specific binding site to the transition state of an enzymatic reaction. The resulting molecules, called abzymes, act like antibodies. In some cases, abzymes can speed up reaction rates as much as 10^7 -fold over the uncatalyzed reaction. The stereospecificity of enzymes (including abzymes) may provide a tremendous aid to the synthesis of stereospecific compounds in organic chemistry.

See also: [Antibodies](#), [Ribozymes](#)

INTERNET LINKS:

1. [Site-Directed Mutagenesis PCR Protocol](#)
 2. [Site-Directed Mutagenesis Using the DUT-UNG System](#)
-

Figure 11.28: A hybrid enzyme.

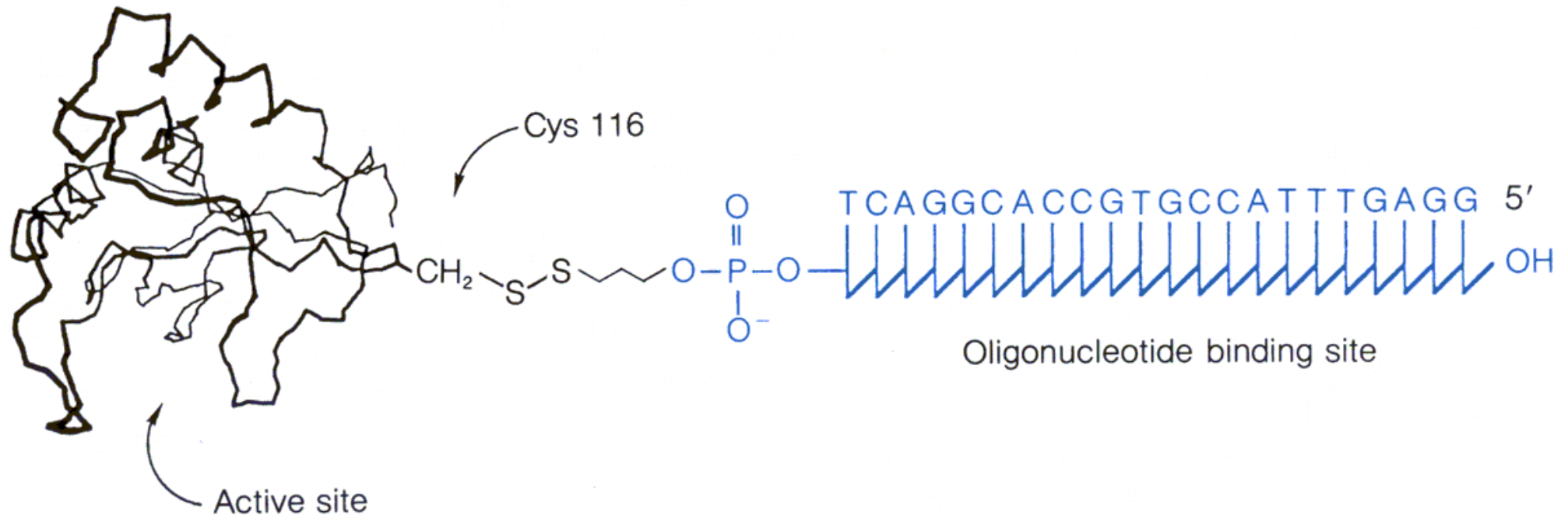

P. G. Schultz, Science (1988) 240:425-432, © 1988 by the AAAS.

Figure 11.29: Cleavage of a typical pre-tRNA by ribonuclease P.

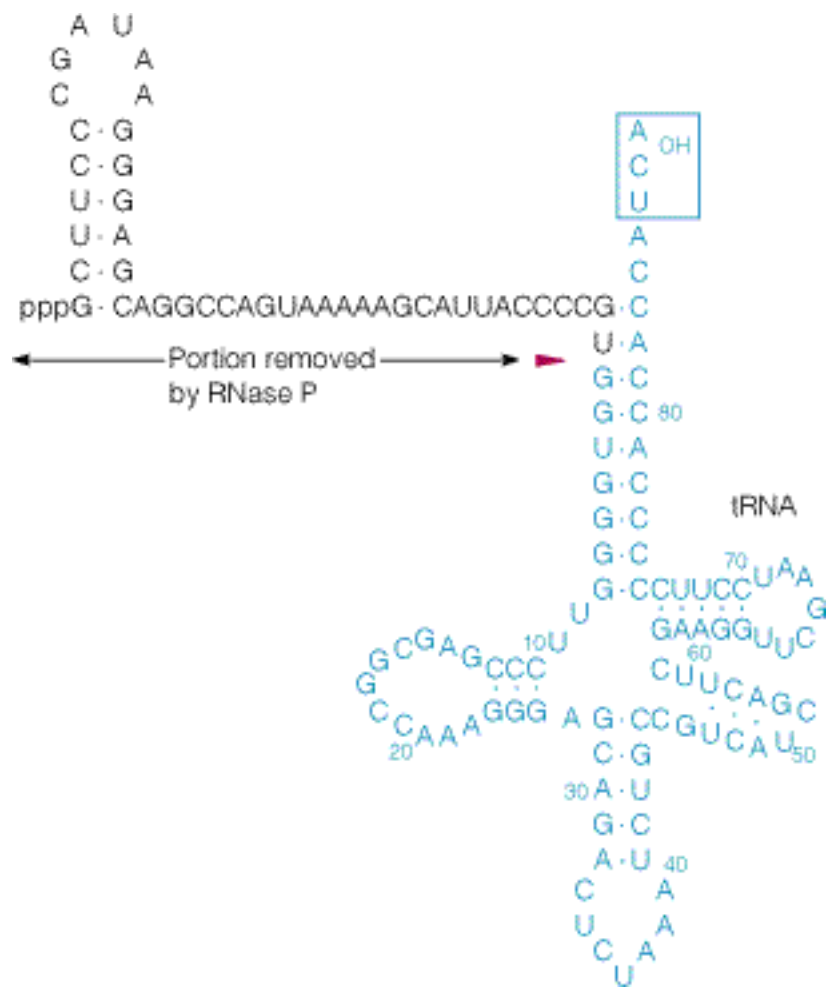

Figure 11.30: Catalysis by the intervening sequence in *Tetrahymena* preribosomal RNA.

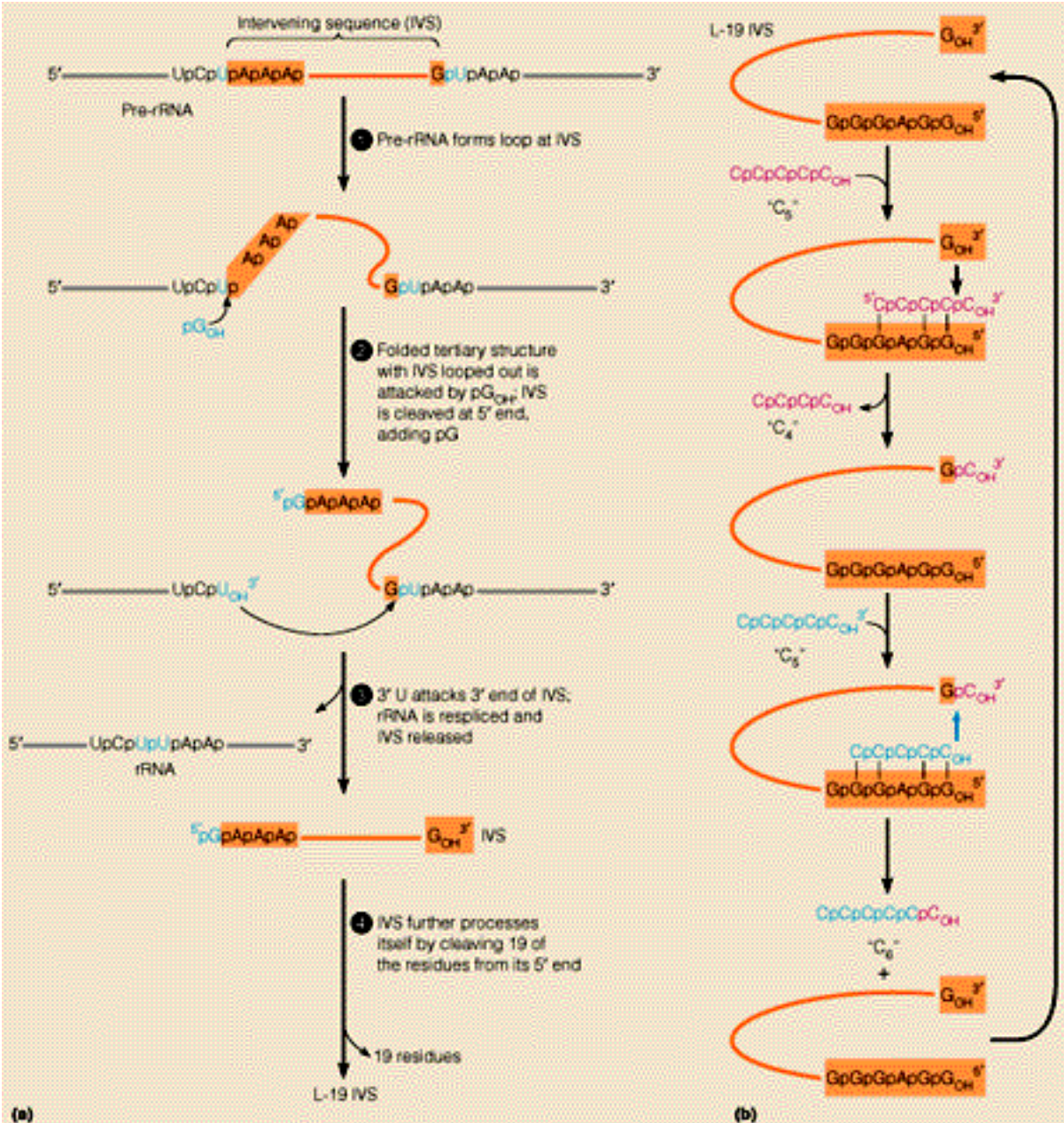
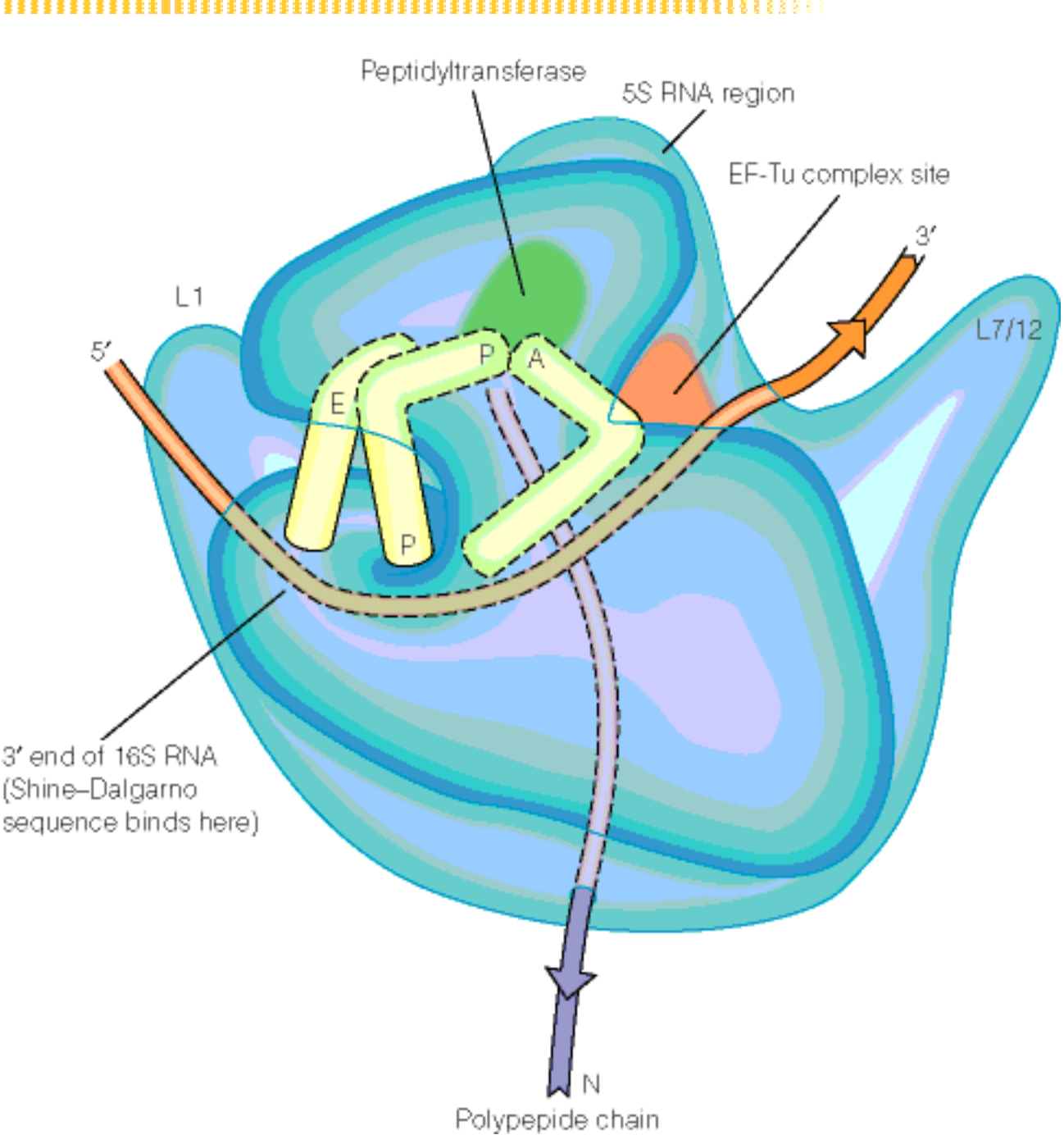

Figure 27.25: A schematic view of functional regions of the ribosome.



Initiation of Translation

Translation occurs in three distinct stages--**initiation**, elongation, and termination. Each step requires specific proteins that interact with the **tRNAs**, **mRNA**, and/or **ribosomes**. Some of these are listed in **Table 27.4**.

Initiation of prokaryotic **translation** is depicted in **Figure 27.20**. Steps include:

1. Two **initiation** factors (IF1 and IF3) bind to a 70S ribosome. IF3 and IF1 appear to promote the dissociation of 70S ribosomes into free 30S and 50S subunits. mRNA and a third **initiation** factor (IF2), which carries a molecule of GTP and the charged **initiator tRNA** bind to a free 30S subunit. IF2 is one of a class of G proteins (see **here**). After these have all bound, the 30S initiation complex is complete.

The initiator tRNA carries an N-formylmethionine. The formyl group is added after the methionine is linked to the tRNA by an enzyme called transformylase. It transfers a formyl group from N¹⁰-formyltetrahydrofolate.

Only tRNA^{fMet} is accepted to form the initiation complex. All further charged tRNAs require fully assembled (i.e., 70S) ribosomes. All prokaryotic proteins are synthesized with the same N-terminal residue, N-formylmethionine.

Near the 3' end of the 16S rRNA is a sequence (3' - UCCUCC -5') that can base pair with a sequence near the 5' end of each mRNA. The sequence in the mRNA is called the Shine-Dalgarno sequence (see **here**). This pairing aligns the message correctly for the start of translation.

2. The 50S subunit binds to the 30S initiation complex. It contains three sites for tRNA binding, called the P site (peptidyl), the A site (aminoacyl), and the E site (exit). When the two ribosomal subunits join, the AUG initiator codon with its bound tRNA^{fMet} aligns with the P site.

3. The **GTP** carried by IF2 is hydrolyzed, and IF2-GDP, Pi, and IF1 are all released. The 70S initiation complex is ready to accept a second charged tRNA and begin elongation, the next phase of translation.

Anticodon ends of the tRNA molecules contact the 30S subunit and the acceptor ends interact with the 50S subunit (**Figure 27.21**).

See also: [Elongation of Translation](#), [Termination of Translation](#), [Eukaryotic vs Prokaryotic Translation](#) (from Chapter 28)

INTERNET LINKS:

1. [Translation Initiation and Elongation Factors](#)
-

Figure 27.20: Initiation of protein biosynthesis in prokaryotes.

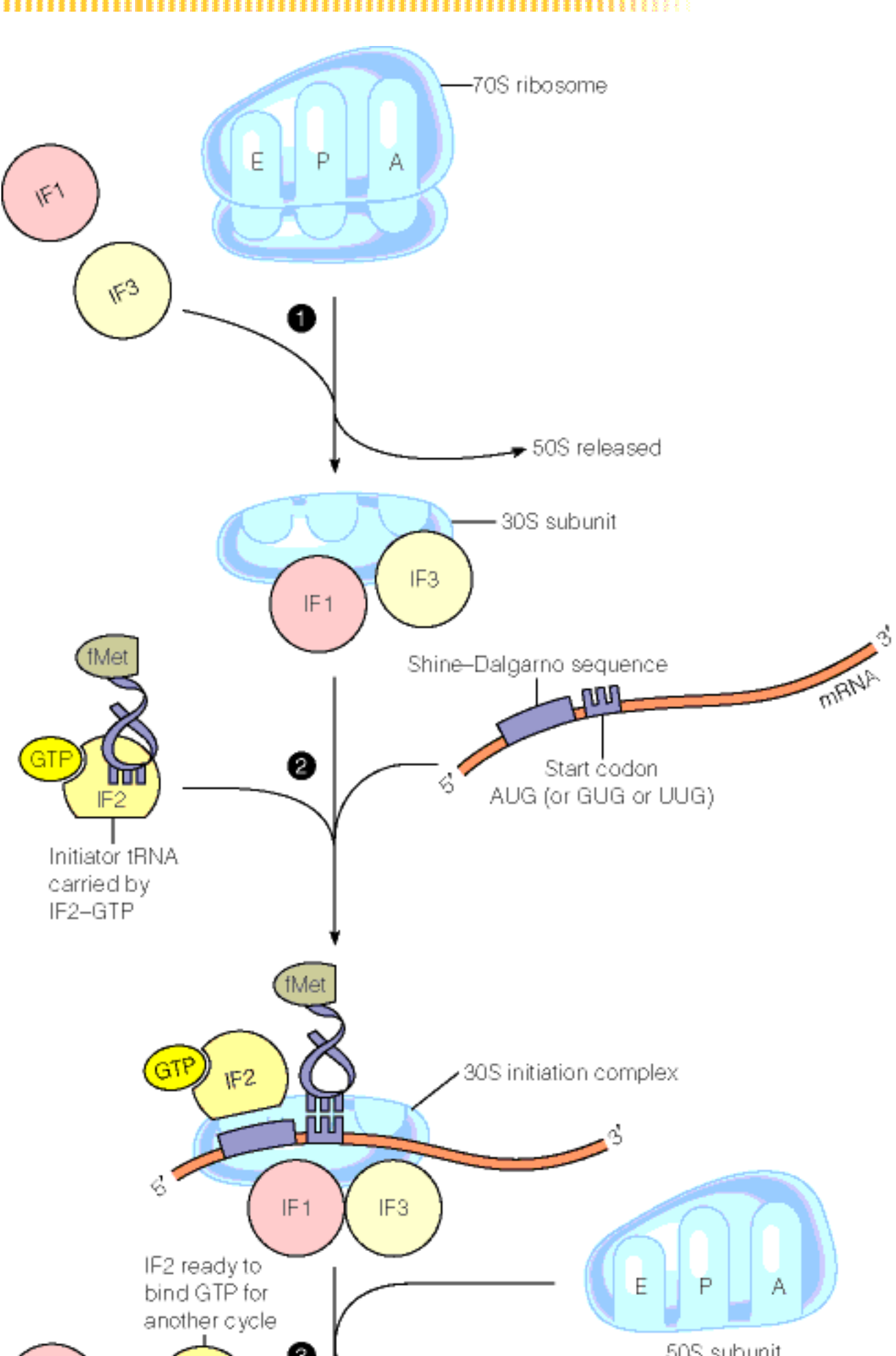

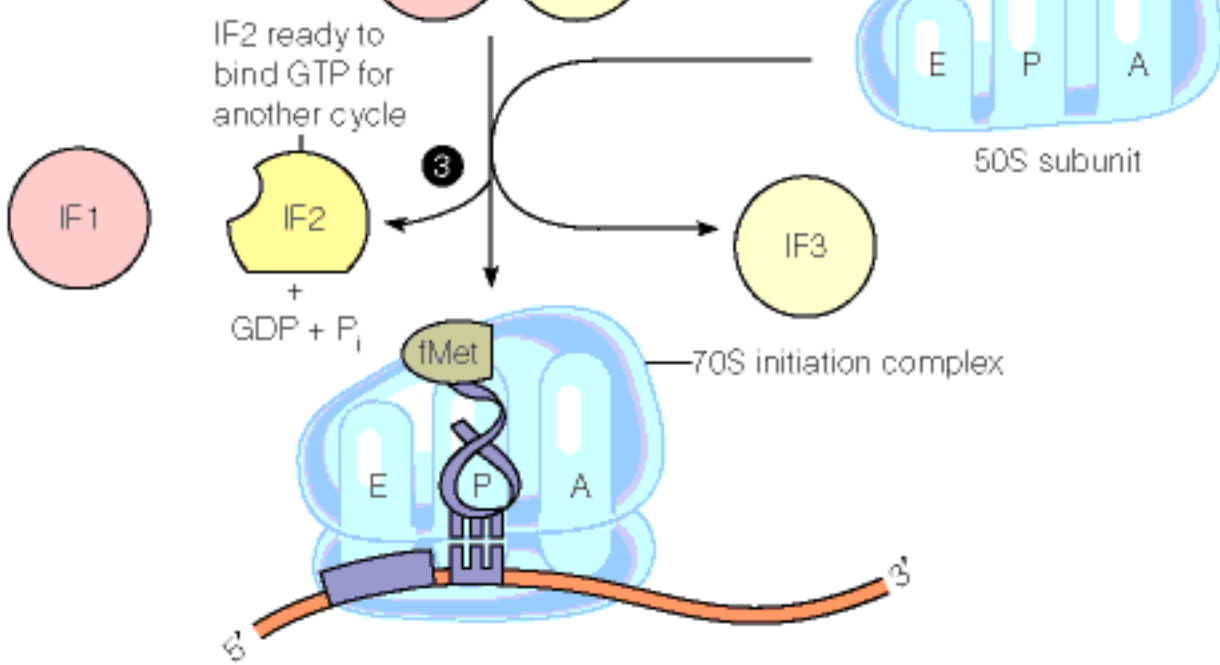
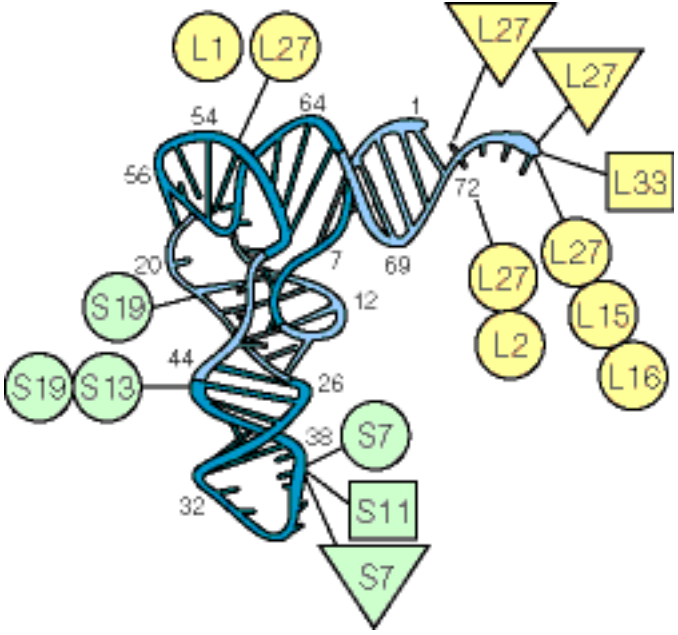

Figure 27.21: Environment of tRNAs at the ribosome as determined by cross-linking.



Courtesy of J. Wower et al., *Biochimie* (1994) 76:1235-1246. © 1994 with permission of Elsevier Science.

Termination of Translation

Translation occurs in three distinct stages--initiation, elongation, and **termination**. Each step requires specific proteins that interact with the tRNAs, mRNA, and/or ribosomes. Some of these are listed in Table 27.4.

Termination of translation occurs when one of the stop codons (UAA, UAG, or UGA) appears in the A site of the ribosome. No tRNAs correspond to those sequences, so no tRNA is bound during **termination**.

Proteins called release factors (Table 27.4) participate in termination. RF1 binds to the ribosome when UAA or UAG is in the A site. RF2 binds when UAA or UGA is in the A site. RF3 is a GTPase that appears to stimulate the release process, via GTP binding and hydrolysis. The sequence of termination events is shown in Figure 27.26. It occurs as follows:

1. RF1 or RF2 binds to the ribosome near the A site. RF3 binds elsewhere.
2. The peptidyltransferase complex transfers the C-terminal residue of the polypeptide chain from the P-site tRNA to a water molecule, releasing the polypeptide chain from the ribosome.
3. The RF factors and GDP are released.
4. The tRNA is released.
5. The 70S ribosome is now unstable in the presence of a protein called ribosome recycling factors, as well as the initiation factors IF3 and IF1. Consequently, the 70S ribosome dissociates to 50S and 30S subunits and is ready for another round of translation.

When the ribosomal subunits separate, the 30S subunit may not always dissociate from its mRNA. For example, in polycistronic messages (more than one protein coded on an mRNA), the 30S subunit may simply slide along the mRNA until the next Shine-Dalgarno sequence (see here) and initiation codon are encountered and begin a new round of translation.

See also: Initiation of Translation, Elongation of Translation, Eukaryotic vs Prokaryotic Translation (from Chapter 28)

Figure 27.26: Termination of translation in prokaryotes.

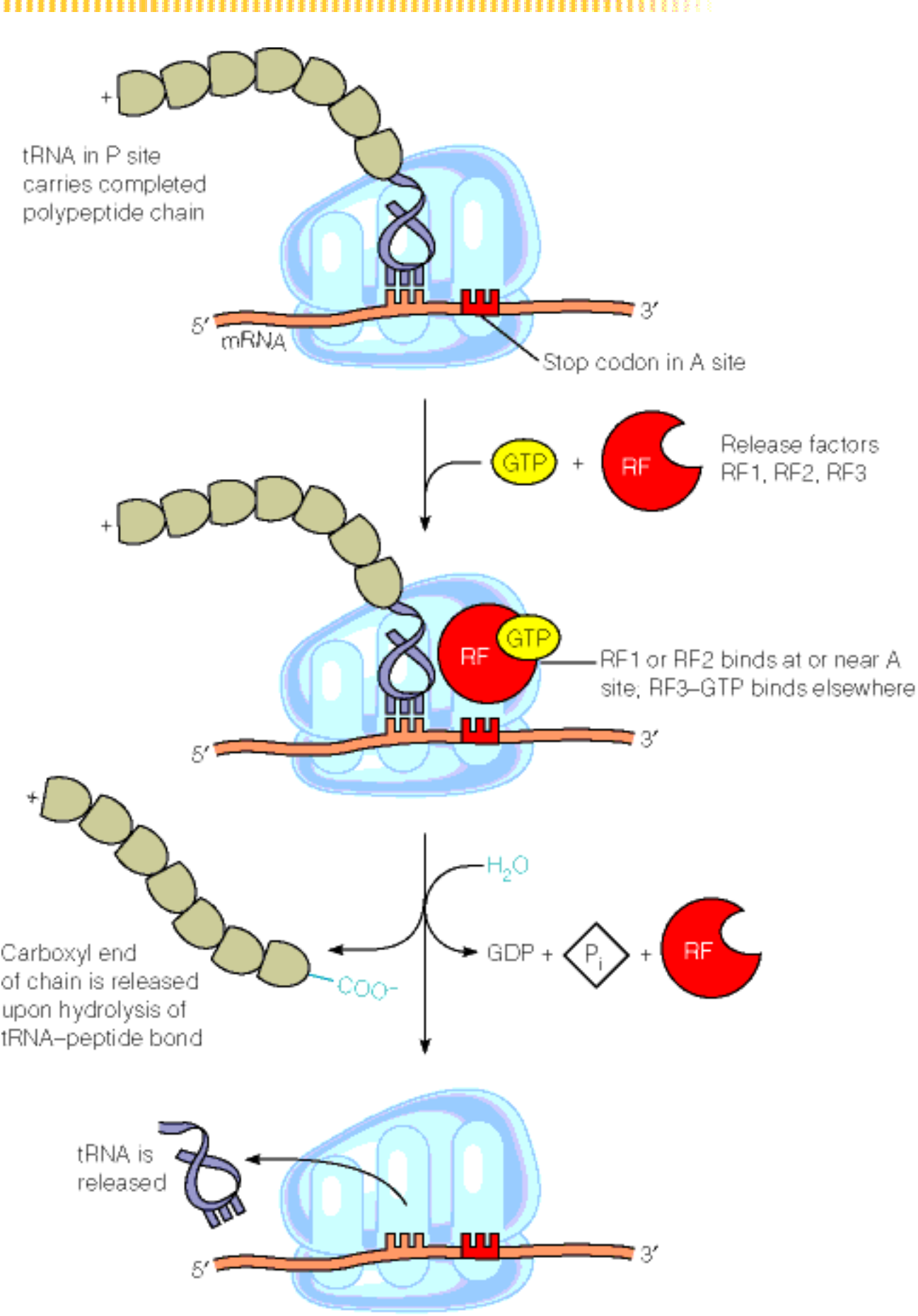

Ribosome dissociates. Probably

Ribosome dissociates. Probably the 50S subunit leaves first, stimulated by binding of IF1 and IF3 (see Figure 27 20). The 30S subunit may either dissociate from the mRNA or move to the next start codon

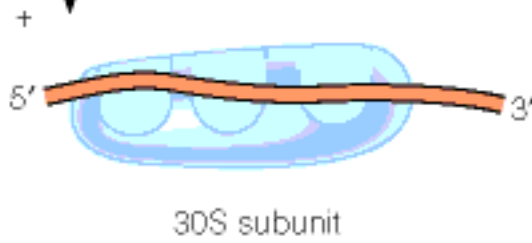

Eukaryotic vs Prokaryotic Translation

The mechanism for translating messenger RNA into protein in eukaryotic cells is basically the same as in prokaryotes. That is, messenger RNA (**mRNA**) is read by **ribosomes**. There are, however, significant differences in both the ribosomes and the details of the translational mechanism.

Ribosomes - The ribosome and its subunits are larger in eukaryotes. 40S and 60S subunits combine to form a functional 80S ribosome. In prokaryotes, the analogous particles are 30S, 50S, and 70S, respectively. The large eukaryotic ribosomal subunit (60S) contains 28S (26S in yeast), 5S, and 5.8S **rRNAs**, the last having no counterpart in prokaryotes. The small subunit (40S) has an 18S rRNA (17S in yeast) versus 16S rRNA in prokaryotes. The eukaryotic ribosomal subunits also contain more proteins than the corresponding prokaryotic particles do.

Initiation - Initiation requires many more protein factors (**Table 28.7**) in eukaryotes than in prokaryotes (11 versus 3)-compare **Figure 28.35** with **Figure 27.20**, for example. Some of the initiation factors attach to the ribosomal subunits and others to mRNA (see left-hand side of **Figure 28.35**). The major initiation factor, eIF2, forms a complex with **tRNA**. This factor is eventually recycled via a cyclic **GDP--GTP** exchange called the eIF2 cycle, which requires the factor eIF2B. Eukaryotic protein synthesis is initiated as it is in prokaryotes, with a special Met-tRNA reading an AUG codon, but the **methionine** is not formylated. The mRNA is aligned correctly on the 40S ribosomal subunit by the 5' cap, rather than by the Shine--Dalgarno sequence (see **here**) used by prokaryotes. The ribosomal subunit then scans along the mRNA (an ATP-dependent process) until the first AUG is found. At this point the initiation factors are released, and the 60S subunit is attached to begin translation.

Elongation and termination - Eukaryotic chain termination, in contrast to prokaryotic termination, requires only one protein factor- eRF (**Table 28.7**), which can recognize all three stop codons (UAA, UAG, and UGA). Otherwise the mechanisms are very similar.

Inhibitors of translation - A number of the common inhibitors of prokaryotic translation are also effective in eukaryotic cells. They include **pactamycin**, **tetracycline**, and **puromycin**. Inhibitors that are effective only in eukaryotes include **cycloheximide** and diphtheria toxin. Cycloheximide inhibits the peptidyltransferase activity of the eukaryotic ribosome. Diphtheria toxin is an enzyme, coded for by a bacteriophage that is lysogenic in the bacterium *Corynebacterium diphtheriae*. It catalyzes a reaction in which NAD⁺ adds an ADP ribose group to a specially modified **histidine** in the translocation factor eEF2, the eukaryotic equivalent of EF-G (**Figure 28.36**). Because the toxin is a catalyst, minute amounts can irreversibly block a cell's protein synthetic machinery. As a result, pure diphtheria toxin is one of the most deadly substances known.

See also: [Control of Translation](#), [Translation Overview](#) (from Chapter 27), [Initiation of Translation](#) (from Chapter 27), [Elongation of Translation](#) (from Chapter 27), [Termination of Translation](#) (from Chapter 27), [Antibiotic Inhibition of Translation](#) (from Chapter 27)

INTERNET LINKS:

- 1. [Translation Initiation and Elongation Factors](#)**
-

Eukaryotic Transcriptional Initiation/Elongation

Eukaryotic mRNA transcription proceeds as follows:

1. The pre-initiation complex ([Figure 28.24](#)) forms.
2. A short region of DNA melts and transcription is initiated.
3. The C-terminal tail of RNA polymerase II becomes strongly phosphorylated and transcription begins, with a helicase unwinding DNA strands ahead of the polymerase complex.
4. A number of the core transcription factors are released and RNA polymerase II, together with TFIIF, moves along the DNA. A residual complex, containing the TATA binding protein (TBP), TFIIA, TATA binding associated factors (TAFs) and probably activator proteins, remains at the start site, ready to initiate another round of transcription.
5. The RNA polymerase II acquires several special elongation factors, some of which assist the enzyme in dealing with pause sites in the DNA. The accessory proteins (which include nucleosome remodeling factors and a specific elongation factor called FACT) also help RNA polymerase II to pass through [nucleosomal](#) arrays in in vitro studies.

See also: [RNA Polymerase II Transcription](#), [Termination of Eukaryotic Transcription](#), [Chromatin Remodeling](#)

INTERNET LINKS:

1. [Eukaryotic Transcription Initiation](#)
 2. [Eukaryotic Promoter Database](#)
-

Termination of Transcription

Termination of mRNA transcription is different in eukaryotes than in prokaryotes (see [here](#) or [here](#)). Whereas the prokaryotic [RNA polymerase](#) recognizes terminator signals, which sometimes function with the aid of the ρ (rho) protein (see [here](#)), eukaryotic [mRNA](#) transcription proceeds as follows:

1. The eukaryotic RNA polymerase II usually continues to transcribe well past the end of the gene.
2. After the end of the gene has been reached, [RNA polymerase II](#) passes through one or more AATAAA sequences, which lie beyond the 3' end of the coding region ([Figure 28.29](#)).
3. The pre-mRNA, carrying this signal as AAUAAA, is then cleaved by a special endonuclease that recognizes the signal and cuts at a site 11 to 30 residues to its 3' side.
4. A tail of polyriboadenylic acid, poly(A), as much as 200 bases long, is added by a special non-template-directed polymerase. The function of the poly(A) tails of eukaryotic mRNAs is unknown. They cannot be essential for all messages, however, because some mRNAs (for example, most [histone](#) mRNAs in higher eukaryotes) do not have them. One idea is that they relate to message stability, because the tail-less messages typically have much shorter lifetimes in the nucleus.

See also: [Eukaryotic Transcription](#), [Eukaryotic Transcriptional Initiation/Elongation](#), [RNA Polymerase II Transcription](#), [Processing of mRNA](#)

INTERNET LINK: [Transcription and Translation](#)

Factor-Independent Termination of Transcription

In bacteria two distinct types of **termination** events have been identified-those that depend on the action of a protein **termination** factor, called ρ (rho), and those that are ρ **factor-independent**.

Factor-independent termination - Sequencing the 3' ends of genes that terminate in a factor-independent manner reveals the following two structural features shared by many such genes and illustrated in [Figure 26.15](#):

1. Two symmetrical GC-rich segments in the transcript have the potential to form a stem-loop structure
2. A downstream run of four to eight A residues.

These features suggest the following as elements of the **termination** mechanism:

1. [RNA Polymerase](#) slows down, or pauses, when it reaches the first GC-rich segment, because the stability of G-C base pairs makes the template hard to unwind. In vitro, RNA polymerase does pause for several minutes at a GC-rich segment.
2. The pausing gives time for the complementary GC-rich parts of the nascent transcript to base-pair with one another. In the process, the downstream GC-rich segment of the transcript is displaced from its template (or from that part of the enzyme molecule to which it is bound; see [Figure 26.8b](#)). Hence, the ternary complex of RNA polymerase, DNA template, and RNA is weakened. Further weakening, leading to dissociation, occurs when the A-rich segment is transcribed to give a series of AU bonds (which are very weak), linking transcript to template.

The actual mechanism of **termination** is more complex than just described, in part because DNA sequences both upstream and downstream from the regions shown in [Figure 26.15](#) also influence **termination** efficiency. Moreover, not all pause sites are **termination** sites.

See also: [Factor-dependent termination of transcription](#), [eukaryotic termination of transcription](#) (from Chapter 28)

Figure 26.15: A model for factor-independent termination of transcription.

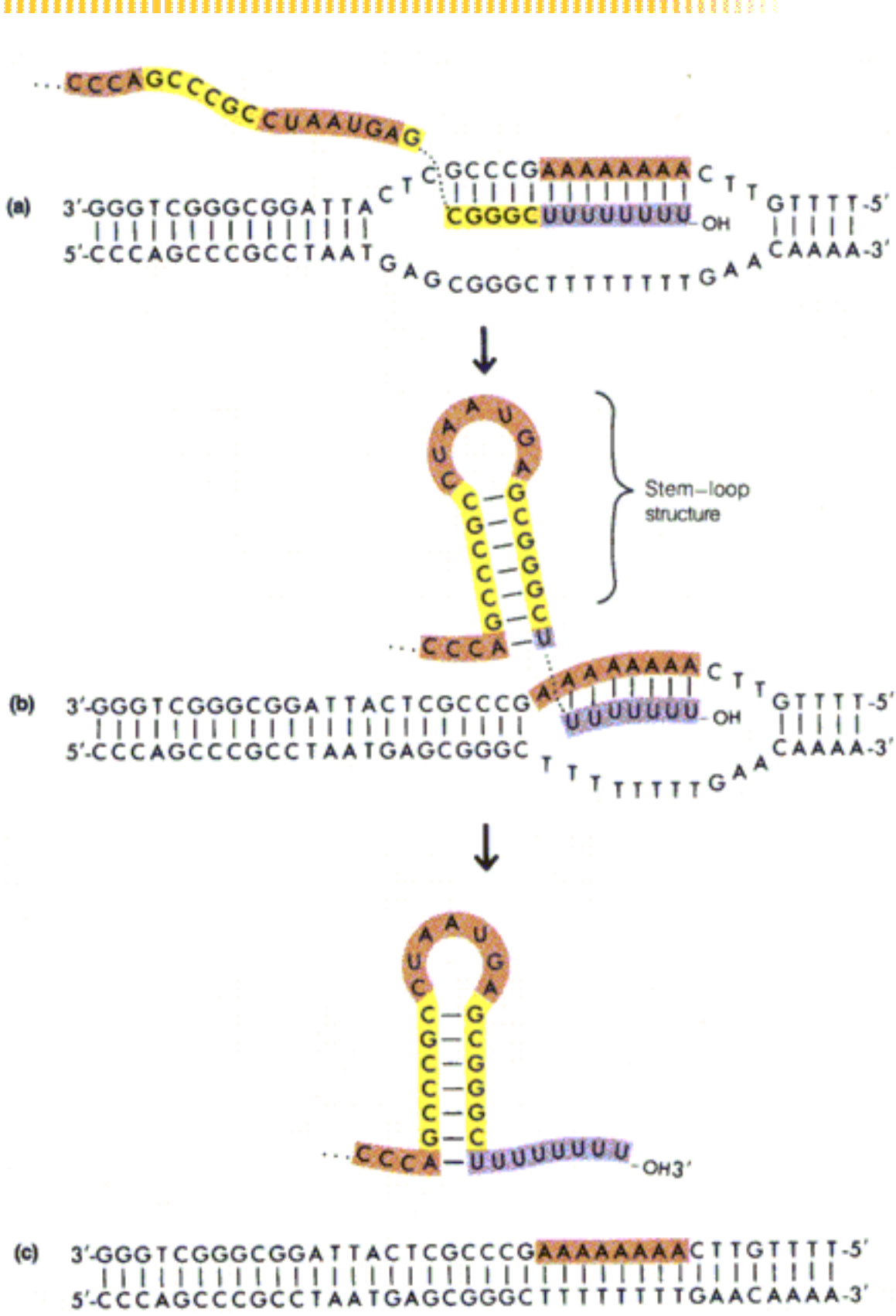

Factor-Dependent Termination

In bacteria two distinct types of termination events have been identified-those that depend on the action of a protein termination factor, called ρ (rho), and those that are ρ factor - independent.

Factor-dependent termination - **Factor-dependent termination** sites are less frequent than factor-independent termination sites, and the mechanism of factor-dependent termination is complex. The ρ protein, a hexamer composed of identical subunits, has been characterized as an RNA--DNA helicase (see [here](#) for more about helicases) and contains a nucleoside triphosphatase activity that is activated by binding to polynucleotides. Apparently ρ acts by binding to the nascent transcript at a specific site near the 3' end, when RNA polymerase has paused ([Figure 26.16](#)). Then ρ moves along the transcript toward the 3' end, with the helicase activity unwinding the 3' end of the transcript from the template (and/or the RNA polymerase molecule), thus causing it to be released.

Involvement of NusA protein - It is not clear what causes [RNA polymerase](#) to pause at ρ -dependent termination sites. However, the action of another protein, NusA, is somehow involved. The NusA protein evidently associates with [RNA polymerase](#), and there is reason to believe that it binds at some point in transcription after the σ factor has dissociated, because the two purified proteins compete with each other for binding to core RNA polymerase.

Attenuation - Further insight into termination mechanisms has come from an extensively studied regulatory mechanism called **attenuation** ([Figure 26.33](#), [Figure 26.36](#)). **Attenuation** controls the rate of transcription of certain operons by terminating the synthesis of a nascent transcript before RNA polymerase has reached the structural genes.

See also: [trp Operon Regulation](#), [Factor-Independent Termination of Transcription](#), [Eukaryotic Termination of Transcription](#) (from Chapter 28)

INTERNET LINK: [E. coli Rho Protein](#)

Figure 26.16: Rho factor (ρ)-dependent termination.

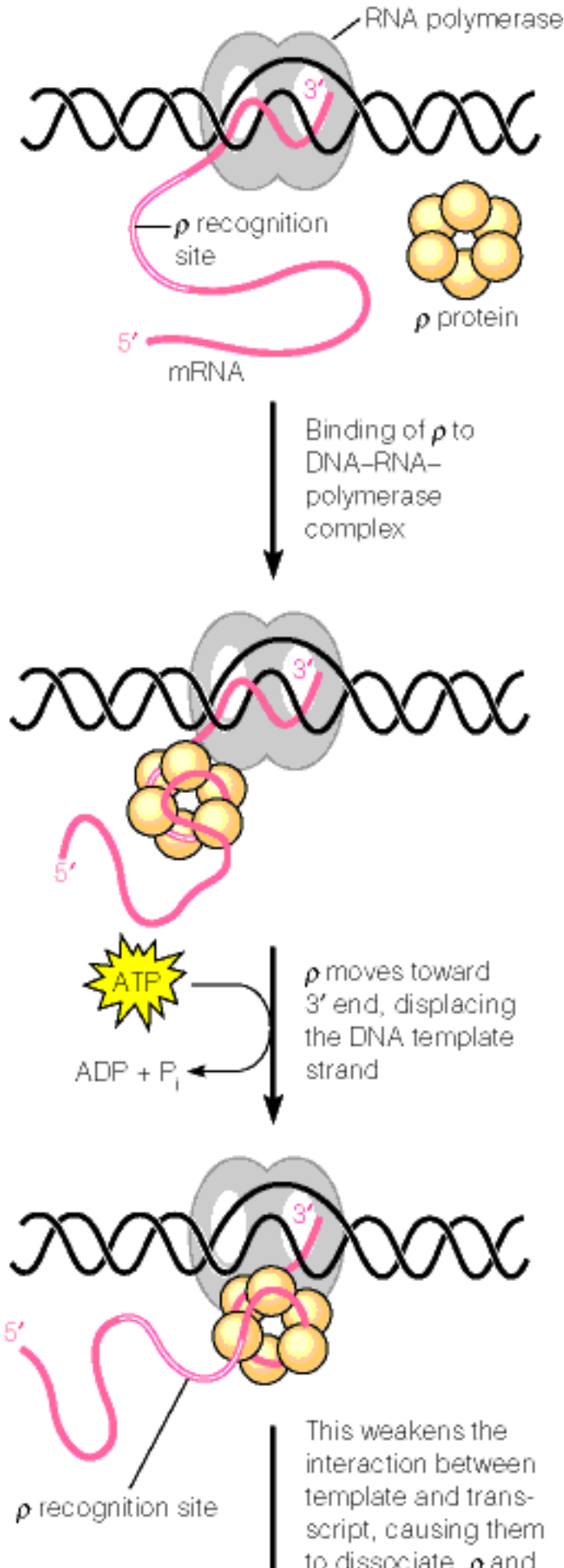

ρ recognition site

This weakens the interaction between template and transcript, causing them to dissociate, ρ and polymerase also dissociate

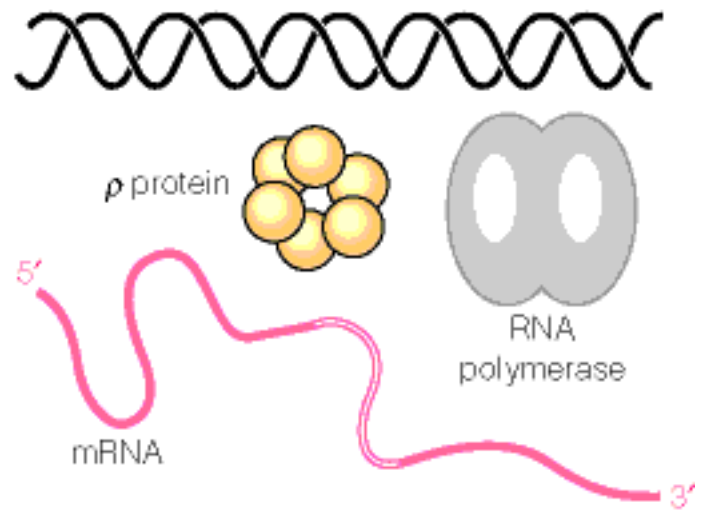

Figure 26.33: The *trp* operon.

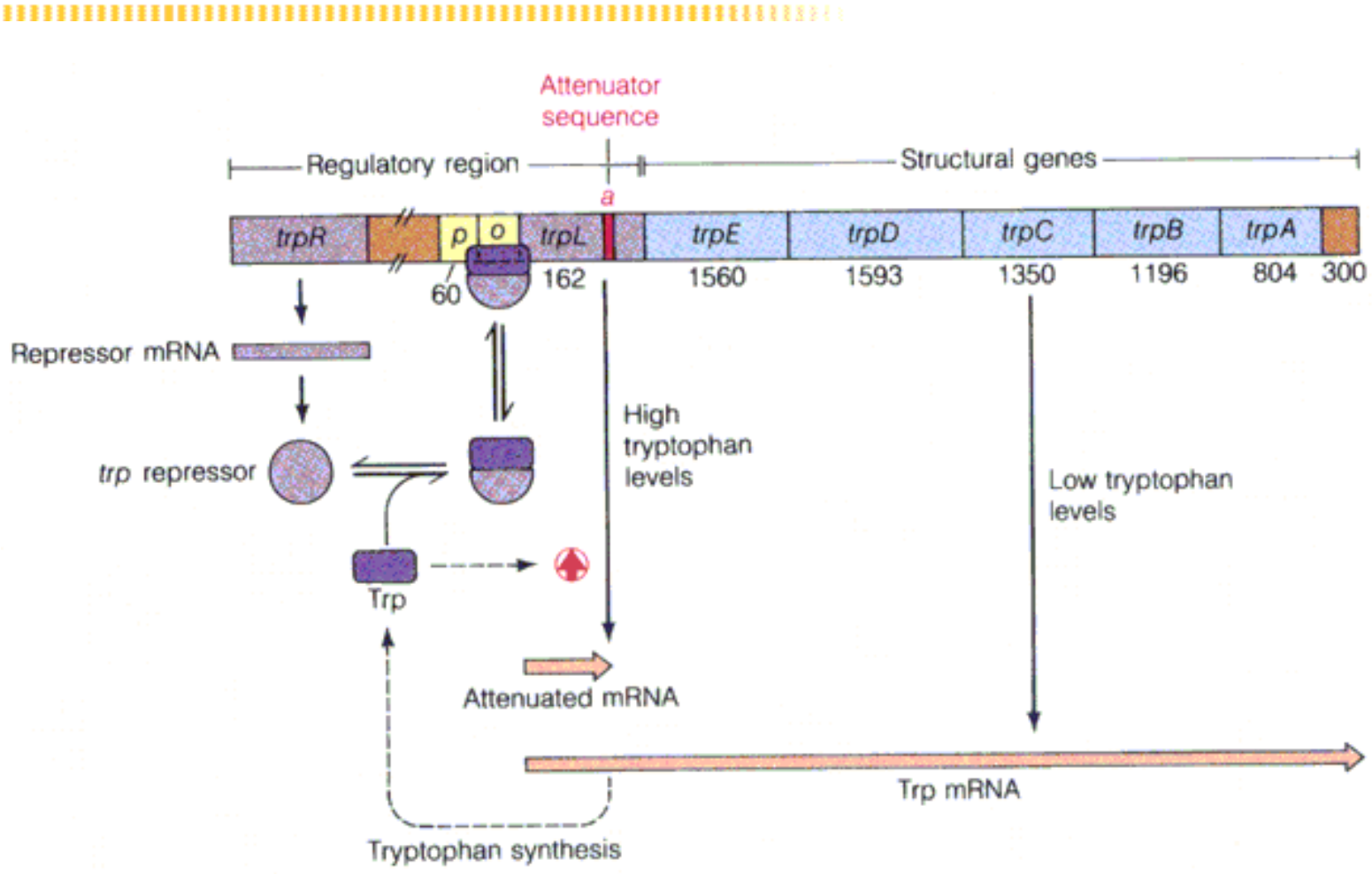
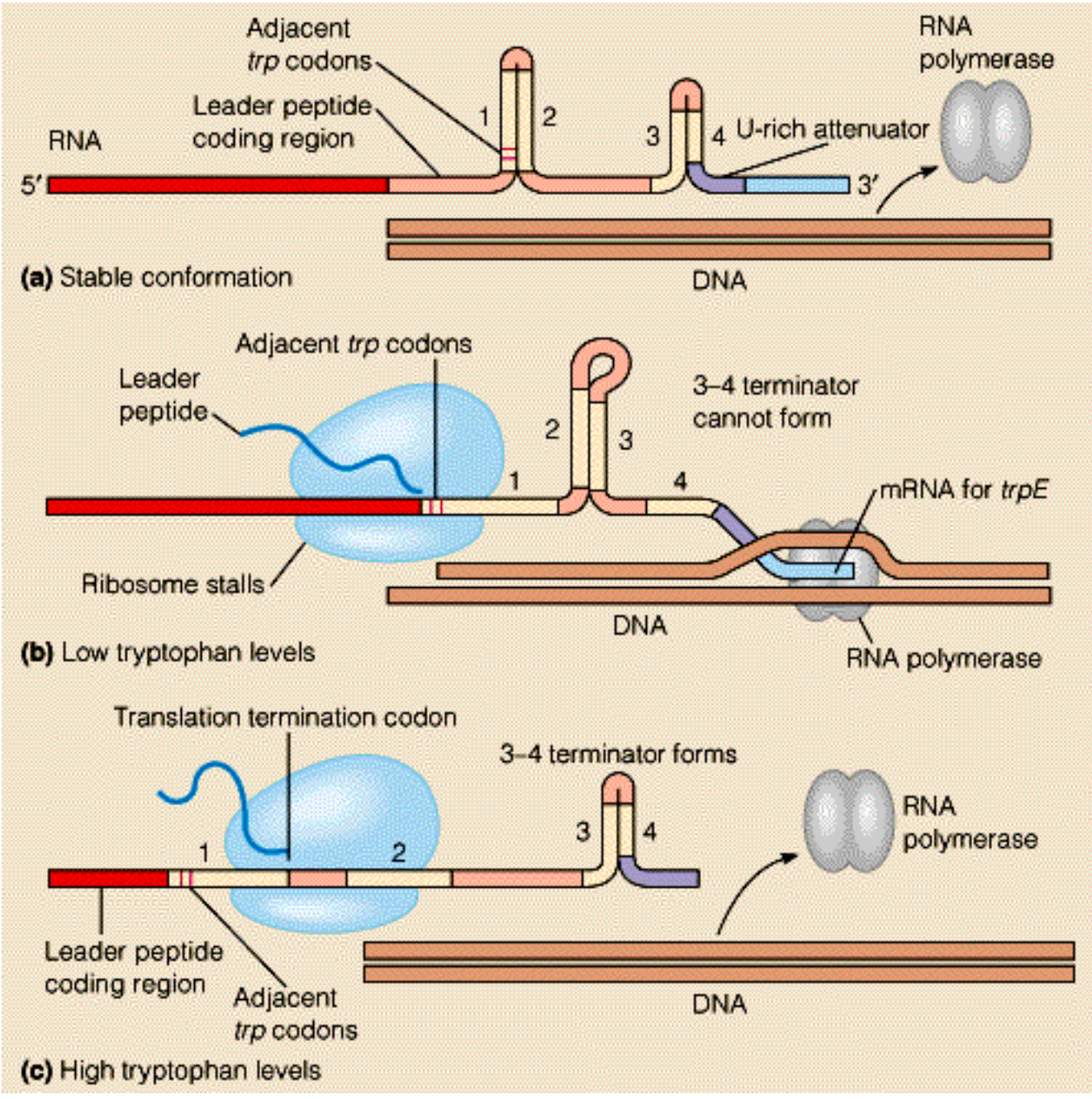

Figure 26.36: Mechanism of attenuation in the *trp* operon.



trp Operon Regulation

The gene products of the lactose operon (see [here](#)) are not needed unless [lactose](#) is also present to be consumed. A different situation is encountered with genes whose products catalyze biosynthesis. Because biosynthesis consumes energy, it is to the cell's advantage to use the preformed product (i.e., an amino acid), if it is available. Therefore, the regulatory goal is to repress gene activity, by turning off the synthesis of enzymes in the pathway when the end product is available.

trp Operon - The **trp operon** consists of five adjacent structural genes whose transcription is controlled from a common promoter - operator regulatory region ([Figure 26.33](#)). Regulation of the *E. coli* **trp operon**, which controls the five reactions from [chorismic acid](#) to [tryptophan](#) (see [Figure 21.14](#)), demonstrates the following two ways of accomplishing this shutdown:

1. A repressor design in which binding of a small-molecule ligand activates the repressor, rather than inactivating it, and
2. Early termination of transcription by **attenuation**.

At low [tryptophan](#) concentration the repressor-operator interaction is the principal regulatory mechanism, whereas the effects of attenuation are more significant at moderate to high tryptophan levels.

trp Repressor - The **trp repressor**, a 58-kilodalton protein encoded by the nonadjacent *trpR* gene, binds tryptophan. The **trp repressor**-tryptophan complex binds to the trp operator and blocks transcription. When intracellular tryptophan levels decrease, the ligand-protein complex dissociates and the free **trp repressor** leaves the operator, so that transcription is activated. The crystal structure of the **trp repressor** - DNA complex shows a helix-turn-helix motif ([Figure 28.23](#)), comparable to that seen with the λ [cI](#), [Cro](#), and [lac](#) repressors.

Attenuation - **Attenuation** is the early termination of trp operon transcription (131 nucleotides from the 5' end of the *trpL* sequence) under conditions of tryptophan abundance ([Figure 26.33](#)). Four oligonucleotide sequences in the *trp* leader region are capable of base-pairing to form stem-loop structures in the RNA transcript ([Figure 26.35](#)). In the most stable conformation ([Figure 26.36a](#)) (when tryptophan levels are high), region 1 pairs with 2, and region 3 pairs with 4, to give two stem - loops. The 3-4 structure, being followed by eight U's, is an efficient transcription terminator, because it resembles the factor-independent terminator structure shown in [Figure 26.15](#). When this happens, the structural genes are not transcribed, so tryptophan is not synthesized.

Low tryptophan levels - When tryptophan levels are low ([Figure 26.36a](#)), cells need to turn on the trp operon. In this case, formation of the 3-4 stem-loop is inhibited, and termination does not occur at the

attenuation site. Region 1 contains two tryptophan codons (see [Figure 26.35](#)). In prokaryotes, translation is coupled to transcription, so a [ribosome](#) can begin translating a message from its 5' end while the message is still being synthesized at its 3' end. When tryptophan levels are low, the ribosome stalls when it reaches the two tryptophan codons, because there is insufficient tryptophanyl-tRNA to translate them. The bulky ribosome on the mRNA prevents region 1 from base-pairing with 2, leaving region 2 free to base-pair with 3. Because region 3 is unavailable to base-pair with 4, the 3-4 stem-loop transcriptional terminator cannot form, and the entire message is synthesized. Conversely, when tryptophan is abundant ([Figure 26.36c](#)), the ribosome does not stall, thereby occluding region 2 and allowing the 3 - 4 stem - loop structure to form, which leads to transcription termination on the 3' side of 3 - 4.

Other Systems - Other attenuation-controlled operons of "stalling sequences" include operons for synthesis of [leucine](#), with four adjacent leucine codons in the leader sequence, and of [histidine](#), with seven. In *Bacillus subtilis*, synthesis of tyrosyl-tRNA synthetase is activated by an antitermination mechanism that allows transcription to proceed past a potential termination site in a leader region. By contrast, termination proceeds efficiently when most of the appropriate tRNA is charged with tyrosine, and there is no need to synthesize more of the aminoacyl-tRNA synthetase ([Figure 26.37](#)).

See also: [Lactose operon regulation](#) [galactose operon](#), [arabinose operon](#)

INTERNET LINKS:

1. [Termination of Transcription](#)
 2. [Helix-Loop-Helix Binding Domains](#)
-

Lac Repressor

Lac repressor properties - The **lac repressor** was isolated in 1966 by Walter Gilbert and Benno Müller-Hill. The purified **lac repressor** is a tetramer, formed from four identical subunits, each with 360 amino acids ($M_r = 38,350$). The protein binds isopropylthiogalactoside (**IPTG**, a synthetic inducer) with a K_a of about 10^6 M^{-1} , and it binds nonspecifically to duplex DNA with a K_a of about $3 \times 10^6 \text{ M}^{-1}$. However, its specific binding at the lac operator is much tighter, with a K_a of 10^{13} M^{-1} . Like RNA polymerase, **lac repressor** seeks its operator site by first binding to DNA at any site and then moving in one dimension along it. It moves either by sliding or by transfer from one site to another, when the two sites are brought next to each other on adjacent loops of DNA.

Lac repressor binding of operator - Control by the **lac repressor** is exceedingly efficient, particularly in view of the minute amount of repressor present in an *E. coli* cell. The *i* gene is expressed at a very low rate, to give about 10 molecules of repressor tetramer per cell. Although this corresponds to a concentration of only about 10^{-8} M , this value is several orders of magnitude higher than the dissociation constant, meaning that in a noninduced cell the operator is bound by **repressor** more than 99.9% of the time--hence, the very low levels of lac operon proteins in uninduced cells (less than one molecule per cell). Binding of inducer by **lac repressor** decreases the affinity of the **repressor-inducer complex** for operator by many orders of magnitude. Under these conditions, nonspecific binding of the **repressor-inducer complex** at other DNA sites becomes significant, so that in induced cells the operator is bound by the **lac repressor** less than 5% of the time.

The Repressor Binding Site - The DNA site bound by **lac repressor** has been analyzed by footprinting and methylation protection experiments. The lac operon operator's DNA sequence comprises 35 base pairs, including 28 base pairs of symmetrical sequence; that is, the sequence is identical in both directions (shaded in the diagram). Thus, the operator is an imperfect palindrome--imperfect because there are 7 base pairs that do not show this symmetry. The transcriptional start point is included within the **repressor**-binding sequence, as shown in the diagram. **Figure 26.19** shows how the operator and promoter overlap, as determined by the regions of DNA protected by binding either **repressor** or RNA polymerase, respectively.

Looped structure - After the lac operon had been sequenced, two additional **lac repressor**- binding sites were located nearby, one centered at position -82, and one within the lacZ gene itself, at position +432. Both sites participate in lac operon regulation. Evidence indicates that a looped DNA structure is essential for complete repression, with the repressor contacting both the -82 and +11 sites. The tetrameric protein consists of two dimeric units, joined by a hinge region. Each dimer binds DNA separately, suggesting that the tetrameric protein binds to both the +11 and -82 sites, creating a DNA loop of 93 base pairs between them.

See also: [Lactose Operon Regulation](#), [cAMP Receptor Protein \(CRP\)](#), [RNA Polymerases](#)

INTERNET LINKS:

1. [The Lac Operon](#)

2. [Induction of the Lac Operon](#)

Figure 26.35: RNA base sequence of the trp leader region.

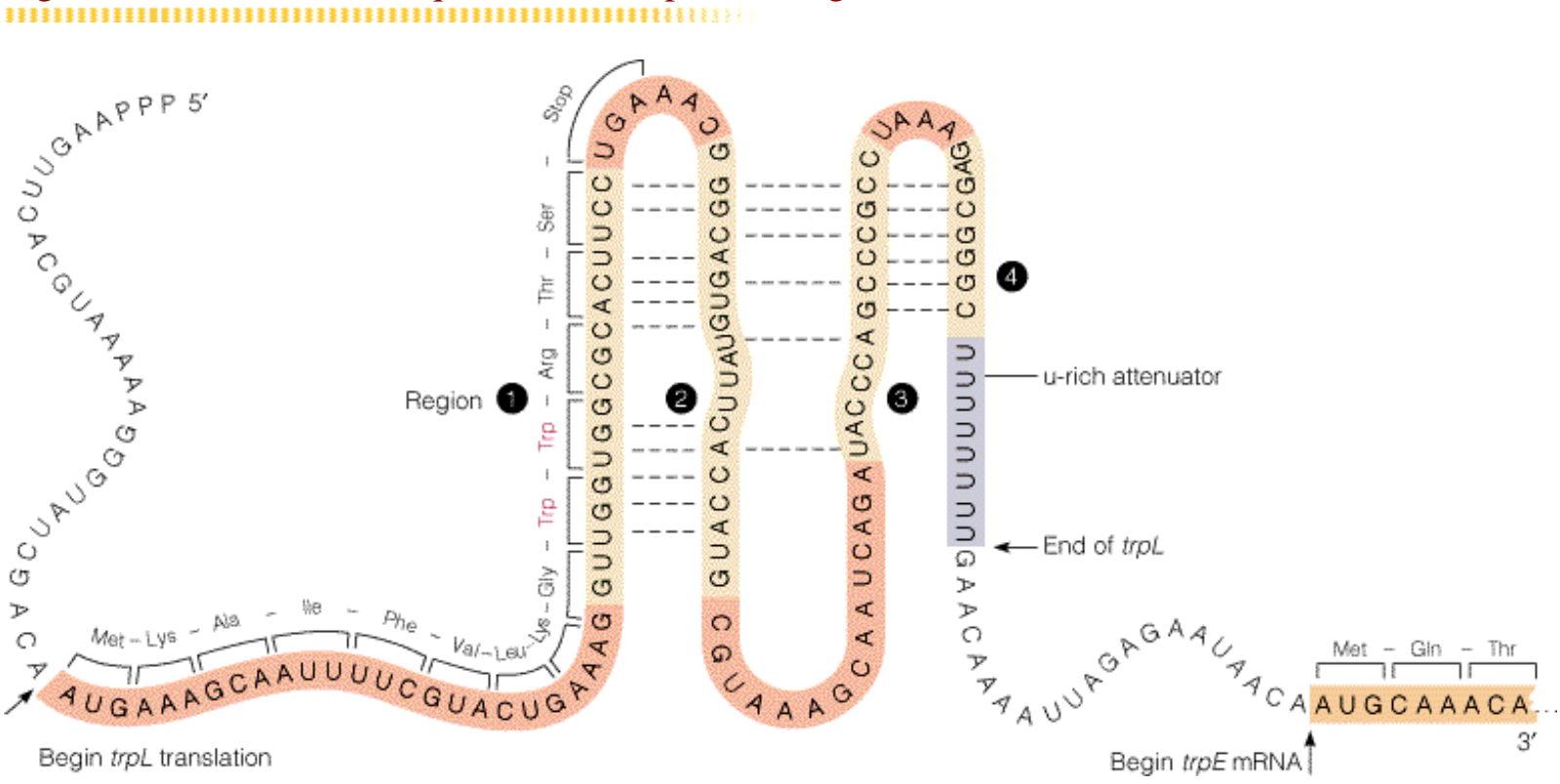
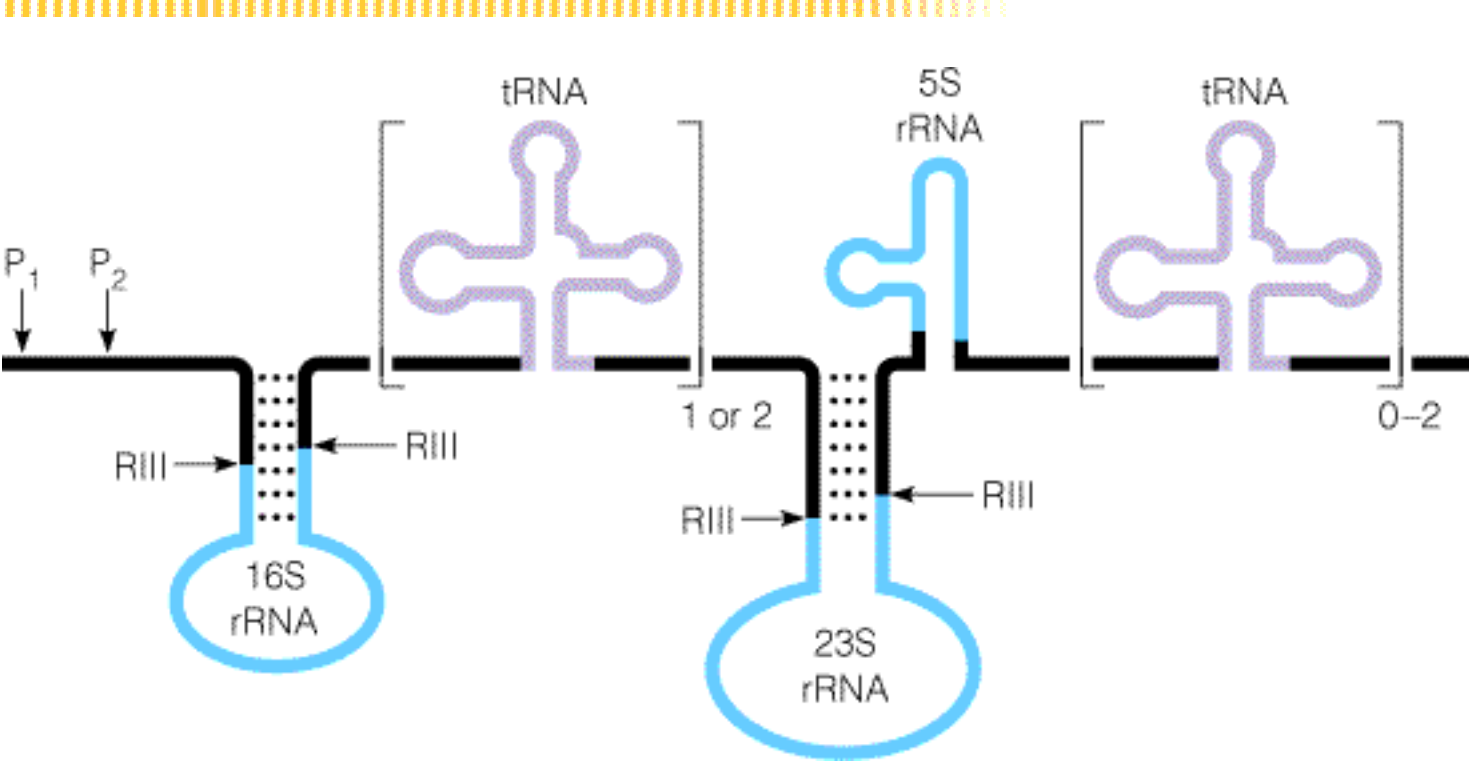

Figure 26.41: Structure of *E. coli* 30S pre-rRNA.



Galactose Operon

The **galactose operon** ([Figure 26.38](#)) controls the utilization of **galactose**, one of the products of **lactose** cleavage by *lac* operon enzymes. The *gal* operon is regulated negatively by a repressor in a manner comparable to *lac* regulation, except that the repressor gene (*galR*) is unlinked to the structural genes.

Overlapping promoters - The *gal* operon contains two overlapping promoters (S1 and S2, [Figure 26.38](#)), leading to transcripts that are initiated just five nucleotides apart.

1. Transcription from the S1 promoter depends on the presence of the cAMP - CRP complex (see [here](#)).
2. The S2 promoter, is used when **glucose** is present.

The details of this dual regulation are not clear, but it is significant that **galactose** has a biosynthetic fate in addition to its role as an energy substrate. **UDP-galactose** is used in synthesis of cell wall lipopolysaccharide, so the second promoter may exist to ensure that UDP-galactose is available even when the cell is using glucose as its prime energy source.

See also: [cAMP receptor protein \(CRP\)](#), [Lac Repressor](#), [trp Operon Regulation](#), [Arabinose Operon](#)

Figure 26.38: Map of the *E. coli* gal operon and nucleotide sequence of the regulatory region.

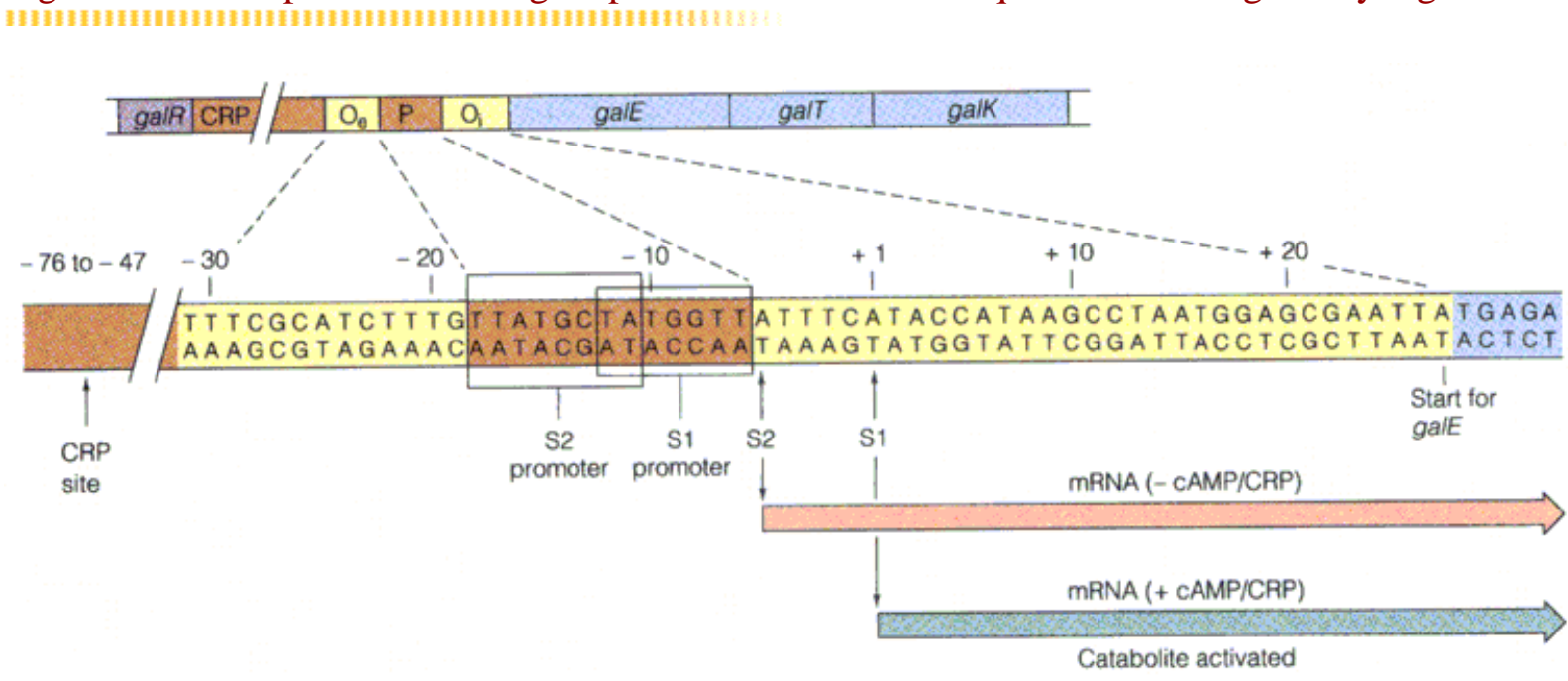

Rifampicin

Rifampicin is an inhibitor of prokaryotic **RNA polymerase**. Since prokaryotes use one RNA polymerase to make all their RNAs, **rifampicin** inhibits all prokaryotic RNA synthesis.

See also:
[Cordycepin](#), [α-Amanitin](#),
[Actinomycin D](#),
[Figure 26.4](#)

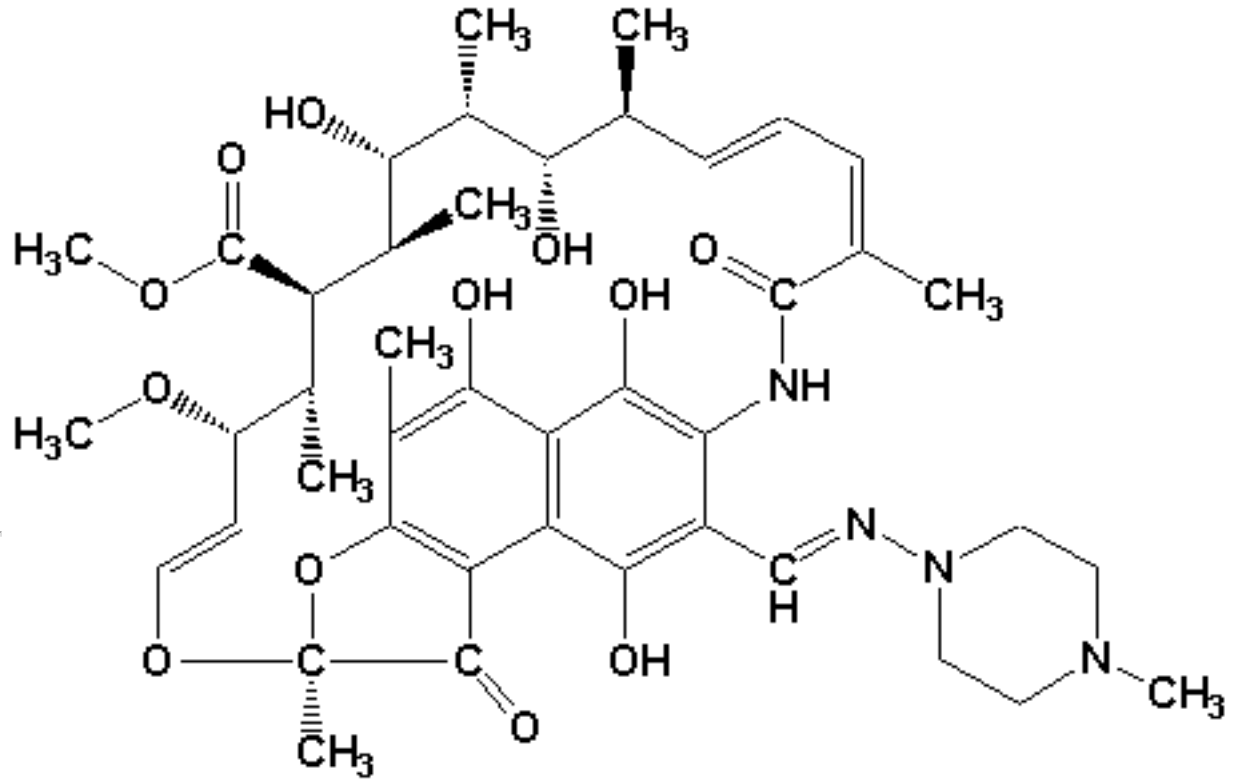

Rifampicin

Cordycepin

Cordycepin, or 3'-deoxyadenosine, is a transcription chain terminator because it lacks a 3' hydroxyl group from which to extend. The nucleotide of **cordycepin** is incorporated into growing chains, confirming that transcriptional chain growth occurs in a 5'to 3' direction.

See also: [α-Amanitin](#), [Actinomycin D](#), [Rifampicin](#), [Figure 26.4](#)

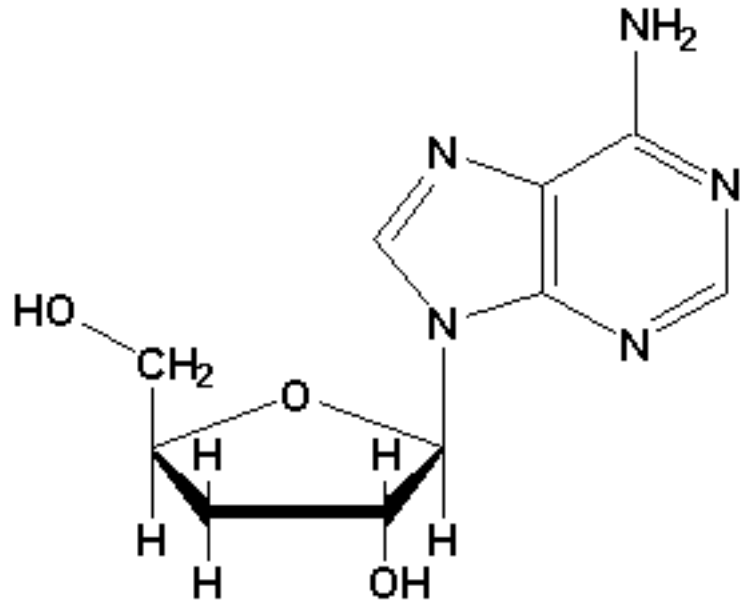

Cordycepin (3'-deoxyadenosine)

α -Amanitin

α -**Amanitin** is a toxin from the poisonous *Amanita* mushroom that inhibits eukaryotic transcription. RNA polymerase II is inhibited by α -**amanitin** at low concentrations, RNA polymerase I is inhibited at high concentrations, and RNA polymerase I is quite resistant.

See also: Cordycepin, Actinomycin D, Rifampicin, Figure 26.4

RNA Polymerase II

RNA polymerase II is a eukaryotic RNA polymerase that transcribes messenger RNAs ([mRNAs](#)). Of the three eukaryotic RNA polymerases, **RNA polymerase II** is the most sensitive to α -amanitin ([Figure 26.4b](#)).

See also: [RNA Polymerases](#), [\$\alpha\$ -Amanitin](#), [RNA Polymerase II Transcription](#)

INTERNET LINKS:

1. [Regulation of Transcription by RNA Polymerase II](#)
 2. [RNA Polymerase and GreA 3D Structures](#)
-

Figure 26.4: Some inhibitors of transcription.

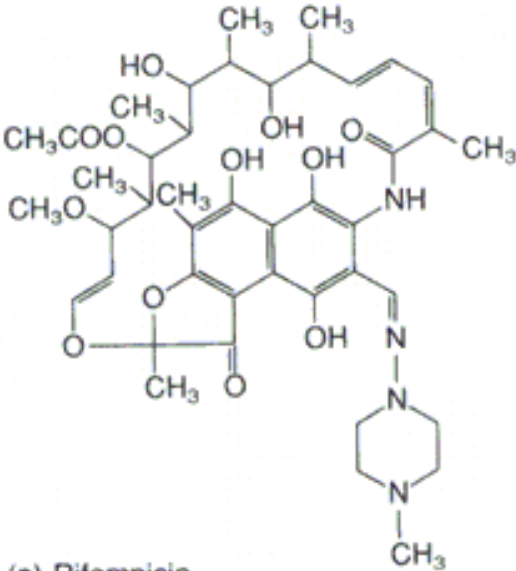

(a) Rifampicin

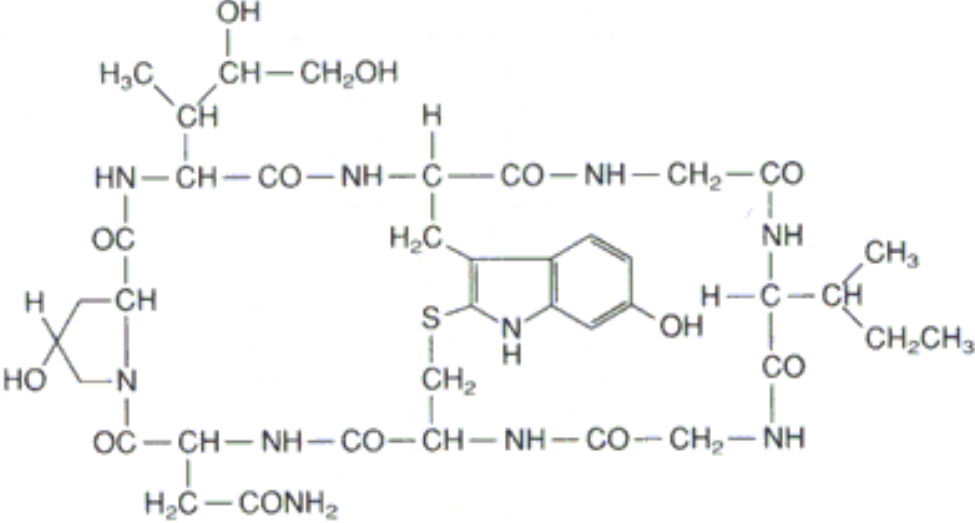

(b) α -Amanitin

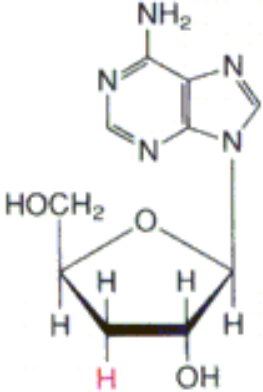

(c) Cordycepin (3'-deoxyadenosine)

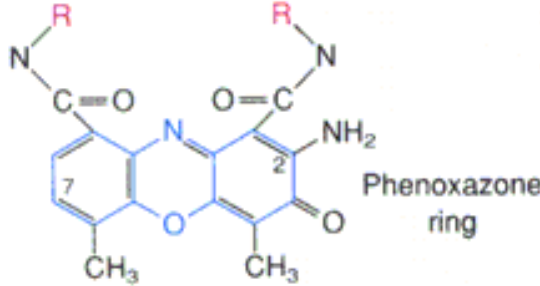

(d) Actinomycin D

RNA Polymerase I

RNA polymerase I is a eukaryotic RNA polymerase that transcribes ribosomal RNAs (**rRNAs**). Of the three eukaryotic RNA polymerases, **RNA polymerase I** is the most resistant to α -amanitin (**Figure 26.4b**).

See also: [RNA Polymerases](#), [\$\alpha\$ -Amanitin](#), [RNA Polymerase I Transcription](#)

INTERNET LINKS:

1. [RNA Polymerase and GreA 3D Structures](#)
-

Actinomycin D

Actinomycin D ([Figure 26.4](#)), is a transcriptional terminator that acts by binding to DNA. The tricyclic ring system (phenoxazone) intercalates between adjacent G-C base pairs, and the cyclic polypeptide arms fill the nearby narrow groove.

See also: [Cordycepin](#), α -[Amanitin](#), [Rifampicin](#), [Figure 26.4](#)

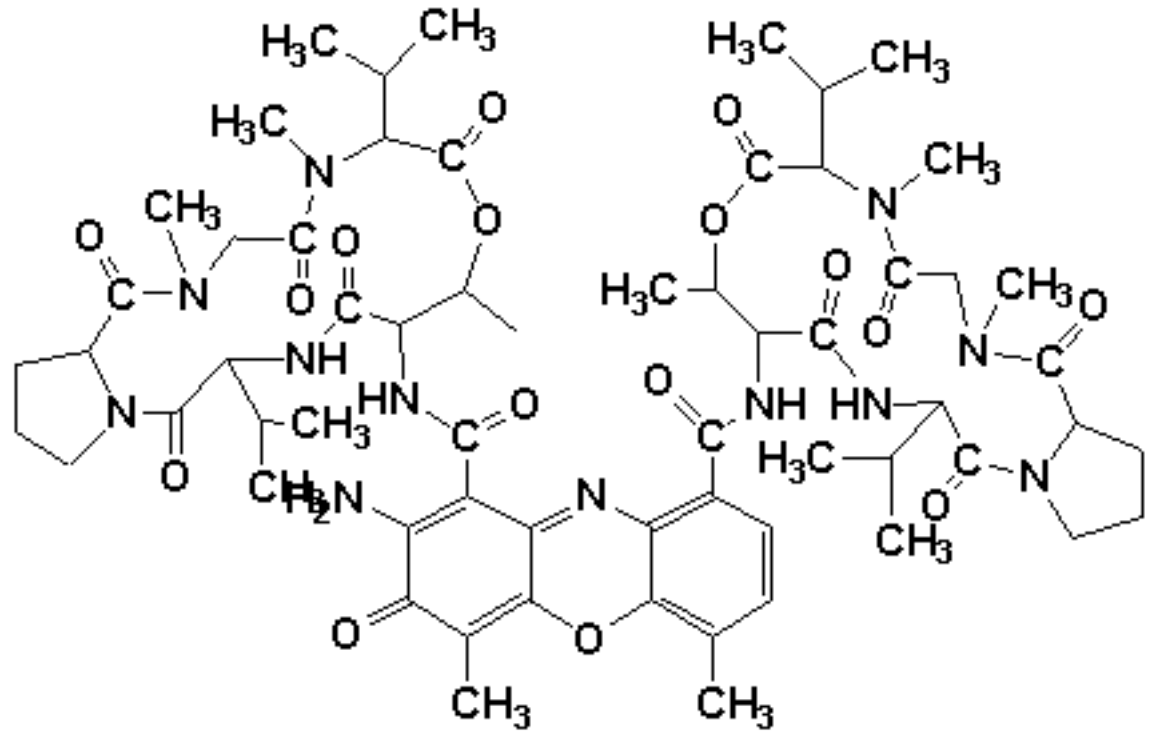

Actinomycin D

Figure 26.9: Protein-nucleic acid interactions in the transcription elongation complex.

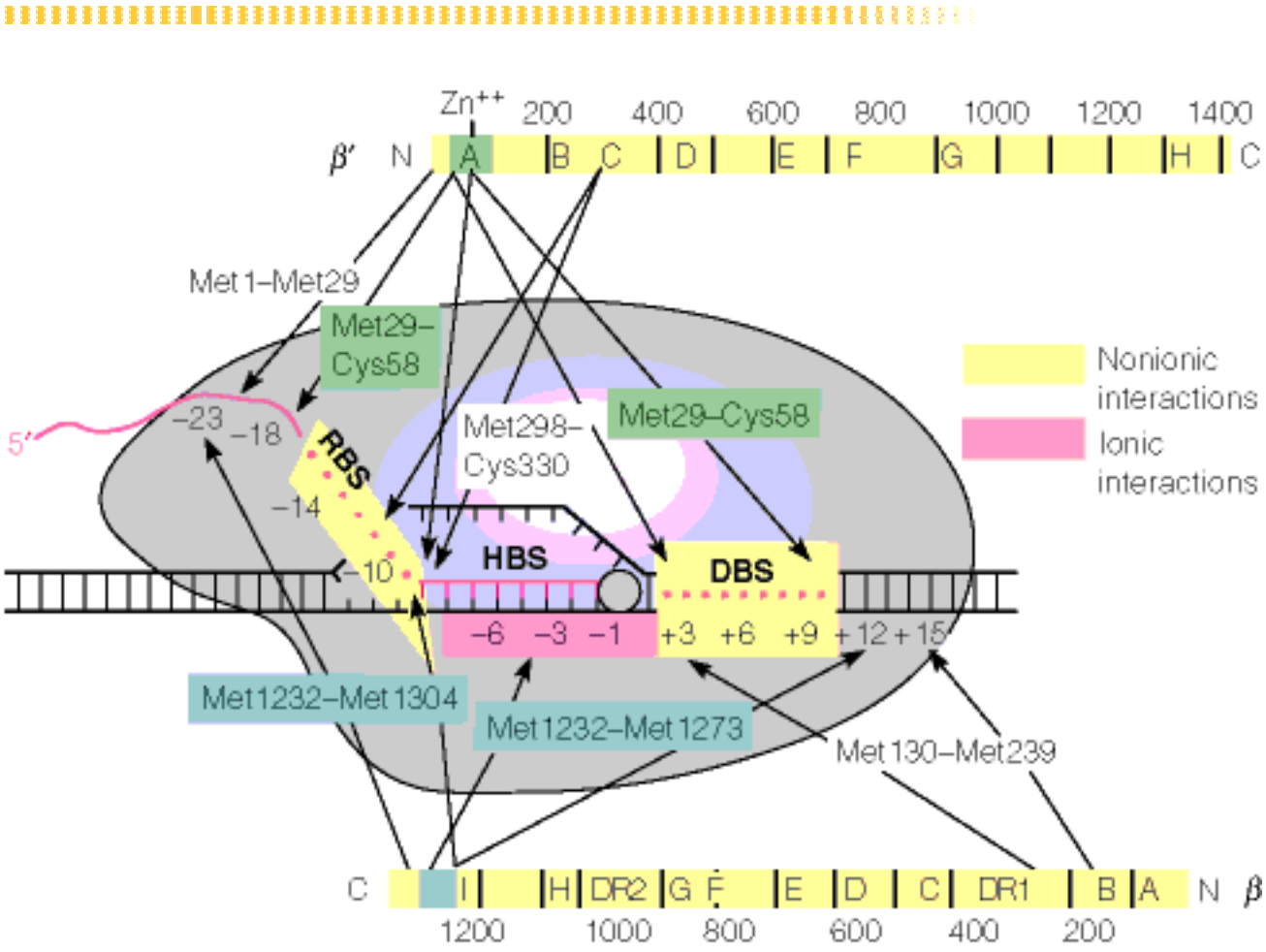

(a)

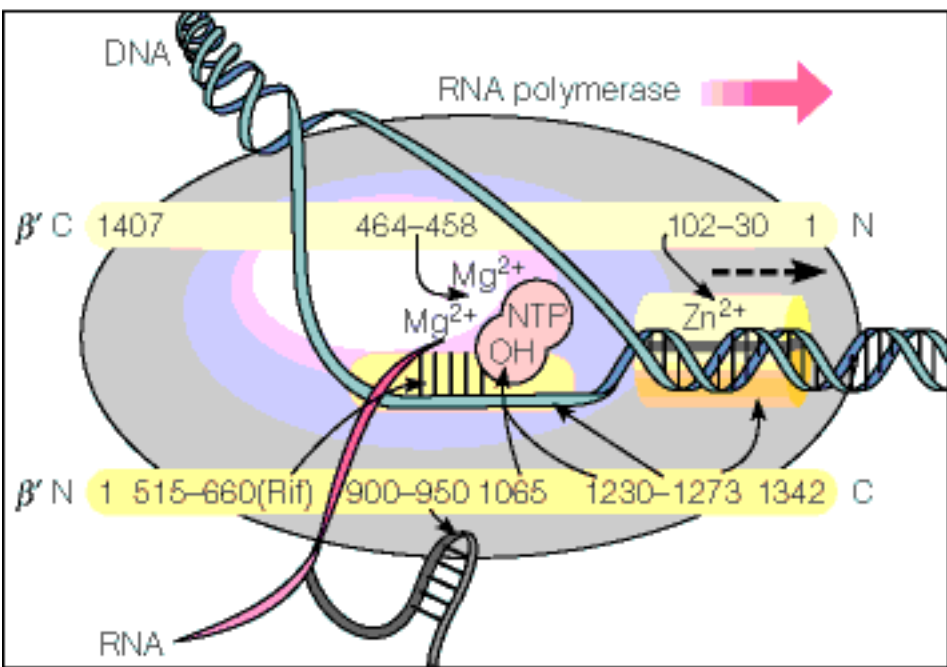

(b)

(a) from E. Nudler, I. Gusarov, E. Avetissova, M. Kozlov, and A. Goldfarb, *Science* (1998) 281:424-428. © 1998 AAAS. (b) from R. Landick and J. W. Roberts, *Science* (1996) 273: 202-203.

Figure 26.10: Backtracking in an elongation complex.

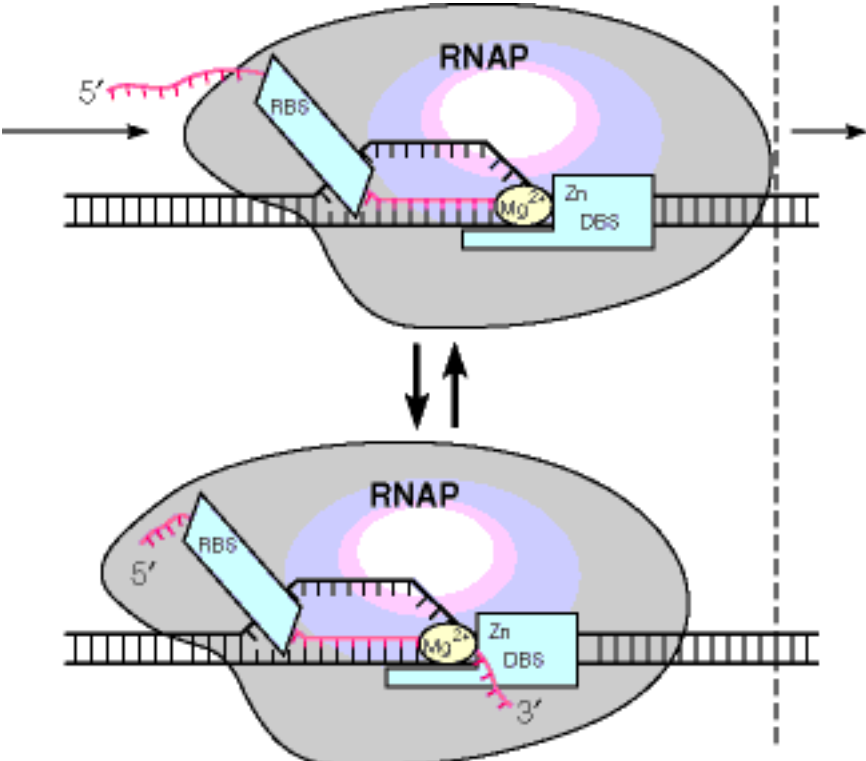

Courtesy of E. Nudler, A. Mustaev, E. Lukhtanov, and A. Goldfarb, Cell (1997) 89:33-41.

Promoter Organization

Transcription initiation rates - In *E. coli*, rates of transcription initiation vary enormously--from about one initiation every 10 seconds for some genes to as infrequently as once per generation (30 to 60 minutes) for others. Because all genes in bacteria are transcribed by the same core enzyme, variations in **promoter** structure must be largely responsible for the great variation in the frequency of initiation. Variations in **promoter** structure represent a simple way for the cell to vary rates of transcription from different genes.

Common sequence motifs - By analyzing DNA sequences ahead of genes, it is possible to identify common sequence features of **promoter** regions. For instance, near position -10 (position +1 is the start site of transcription), a common sequence motif is present in *E. coli* that is close to (or exactly) the sequence TATAAT on the sense strand (nontranscribed DNA strand). Another region of conserved nucleotide sequence is centered at nucleotide -35, with a consensus sequence of TTGACA. No known natural **promoter** has -35 and -10 regions that are identical to the consensus sequences, but in general, the more closely these regions in a **promoter** resemble the consensus sequences, the more efficient that **promoter** is in initiating transcription. [Figure 26.12](#) indicates the extent to which different nucleotides are conserved.

Mutations and spacing - Mutations in **promoter** regions affect transcription efficiency *in vivo*. As shown in [Figure 26.12](#), most of the **promoter** mutations that have been sequenced change the structure of either the -35 region or the -10 region, pointing directly to those sequences as having the greatest effect on transcriptional initiation efficiency. Although most natural **promoters** have a 17-nucleotide spacer between the -35 and -10 regions, many have 16 or 18. *In vitro* studies show that a 17-nucleotide spacer yields the most efficient **promoter** structure.

RNA polymerase contacts - The -35 region and the -10 region, plus a few nucleotides upstream of -10, are the major contact points for RNA polymerase in an open-**promoter** complex. The RNA polymerase α subunit also makes contact in the -40 to -60 region. [Figure 26.14](#) summarizes the results of these contacts for a **promoter**. Because there are two turns of the helix between the -35 and -10 regions, RNA polymerase is postulated to bind to DNA primarily on one side of the duplex. The data on nucleotide reactivity support this conclusion.

Super helicity - Another factor affecting transcriptional efficiency, in addition to the base sequence of the **promoter**, is the superhelical tension on the DNA template. The relation between DNA topology and transcriptional efficiency is not completely clear, because the transcription of some genes is activated *in vivo* when the template is highly supercoiled, but the transcription of other genes is inhibited under the same conditions. Interestingly, the **promoter** for transcription of [DNA gyrase](#) subunits becomes activated when the gene is in a relaxed state. Given that gyrase introduces superhelical turns, this finding seems to represent a feedback mechanism in which the cell responds appropriately to a signal that intracellular DNA is becoming too relaxed.

See also: [Initiation and Elongation](#), [Structure of RNA Polymerase](#), [Transcription Regulation in Phage \$\lambda\$](#) , [Lactose Operon Regulation](#), [Supercoiling](#) (from Chapter 4)

INTERNET LINK: [Supercoiling](#)

Figure 26.12: Survey of conserved nucleotides in *E. coli* promoters.

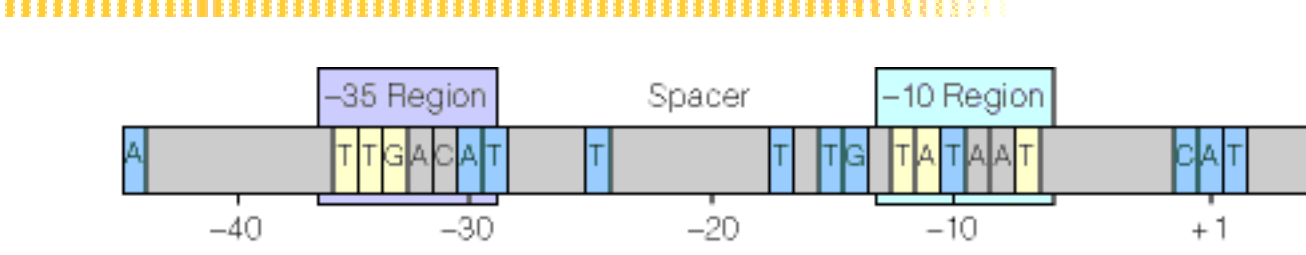

(a)

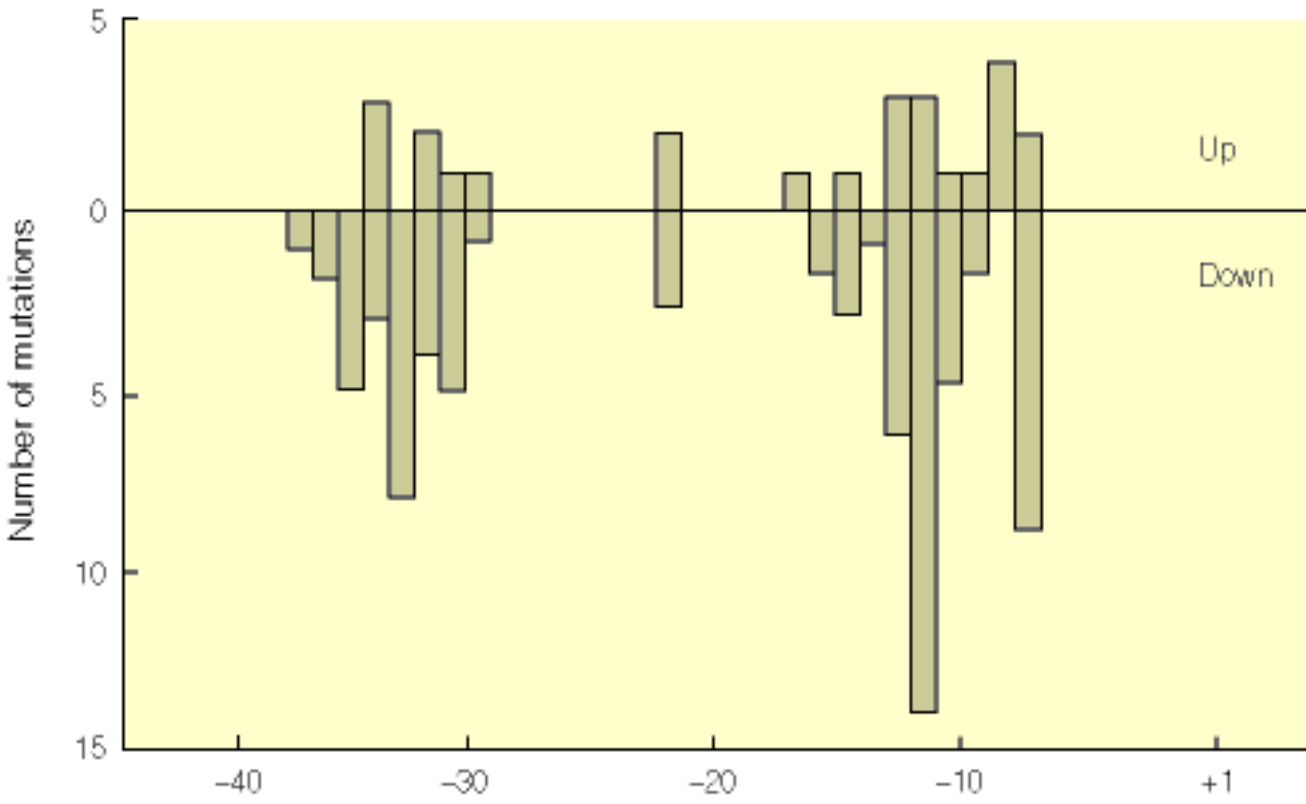

(b)

Reproduced with permission from D. Hawley and W. R. McClure, *Annu. Rev. Biochem.* (1985) 54:171-204. © 1985 by Annual Reviews, Inc.

Figure 26.14: Structure of the T7 A3 promoter.

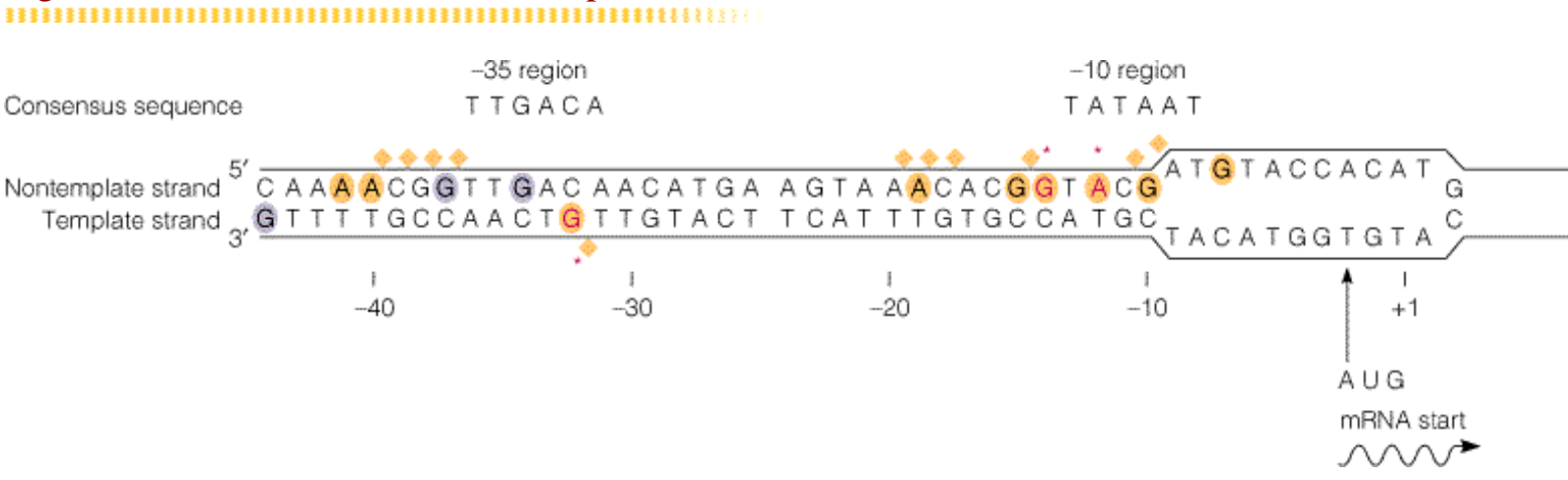

Courtesy of U. Siebenlist and W. Gilbert, Proc. Natl. Acad. Sci. USA (1980) 77:125. © 1980 National Academy of Sciences, USA.

Figure 28.29: Termination of transcription in eukaryotes: addition of poly (A) tails.

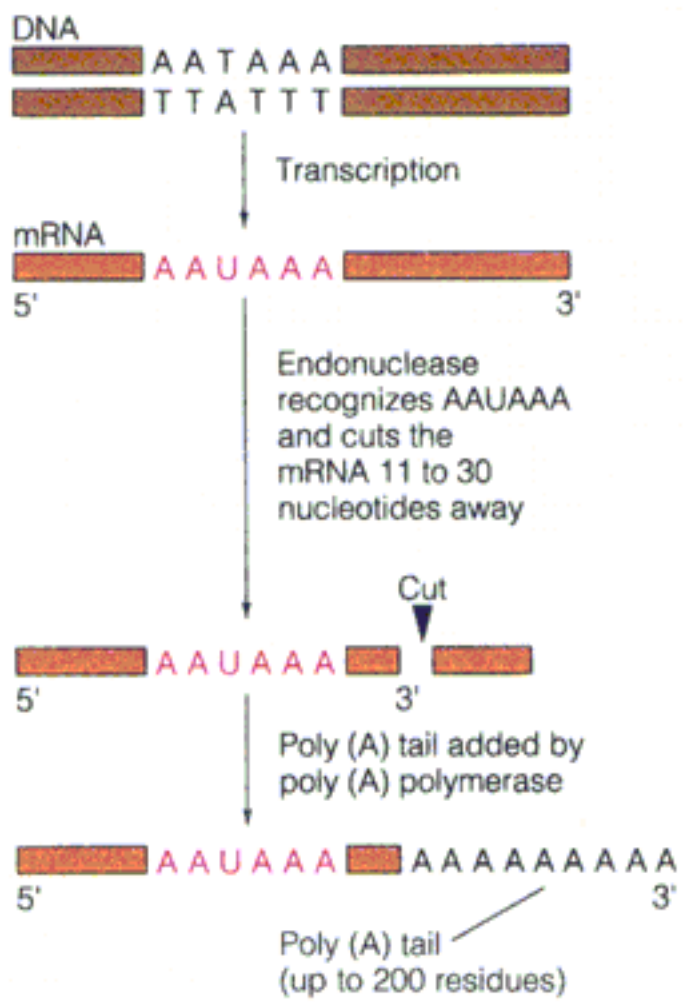

Chromatin Remodeling

Chromatin remodeling factors - These are proteins that enable promoter regions to be able to accept the [RNA polymerase](#) complex and bulky machinery depicted in [Figure 28.24](#). Examples of **chromatin remodeling factors** include the SWI/SNF complex from yeast and the NURF complex from Drosophila. Both require ATP hydrolysis to carry out their task. The two complexes do not seem to remove nucleosomes from the DNA, but rather "open" them in some way.

Another way in which regions of DNA can be transcriptionally activated is by acetylation of specific [lysine](#) residues in the N-terminal tails ([Figure 28.28](#)) of [histones](#) in the nucleosomal core. A number of proteins recruited to the initiation complex by transcriptional activators and TATA binding associated factors TAFs have histone acetylase activity. Acetylation of histones in promoter nucleosomes may help loosen the chromatin structure in these regions.

See also: [Eukaryotic Transcription](#), [Chromatin Structure and Transcription](#), [Nucleosomes](#)

INTERNET LINK: [Transcription Regulation in Chromatin](#)

Chromatin Structure and Transcription

The complex interplay of **transcription factors** and polymerases occurs not on naked DNA, but on **chromatin**. The chromatin structure presents two major problems:

1. How can the transcription factors and initiation complex bind to DNA in the presence of nucleosomes?

Human β globin genes - Although present in every human cell, human globin genes are expressed only in the erythroid cells and in a fixed developmental sequence (see [here](#)). In embryonic cells that have not yet begun synthesis of any globin, the chromatin of the β globin gene cluster appears much the same as in any other cell in the embryo and is quite densely covered with **nucleosomes**. When differentiation of these cells commits them to globin synthesis, however, the whole β globin domain undergoes changes in chromatin structure, including the appearance of regions of DNA particularly susceptible to digestion by nucleases (i.e., not covered by proteins). At the early stages in developing human embryos, these sites appear in the 5' flanking regions of the embryonic genes, which are the first to be transcribed. Later, hypersensitive sites shift to the 5' flanks of the adult genes. Many of these sites represent nucleosome-free regions a few tens or hundreds of base pairs in length. They provide points at which transcription factors and other *trans*-acting proteins can gain access to promoters and enhancers, thereby allowing the initiation and stimulation of transcription. In the globin genes, it appears that the chromatin structure is rearranged at the time of replication, so as to expose DNA in the relevant portions of chromatin.

Chicken egg white proteins - Another mechanism for exposing DNA regions in chromatin employs protein factors that are able to interfere with chromatin structure at specific loci. For example, transcription of the genes for the chicken egg white proteins ovalbumin, ovomucoid, and lysozyme, is regulated hormonally. Specific hypersensitive sites 5' to some of the egg-white protein genes are opened by the presence of estrogen. Withdrawal of estrogen from an immature chick leads to loss of the hypersensitive sites and an immediate cessation of transcription of the genes. In the hormonal control of transcription, target cells contain specific proteins that bind hormones. When bound to hormone, these proteins are capable of interacting with specific DNA sites or with nonhistone regulatory proteins bound to such sites. Both positive and negative regulation is possible. In some cases, the hormone-binding receptor acts as a positive regulatory factor (for example, by binding to an enhancer element). In others, the hormone-binding receptor can interact with a repressor protein to augment or relieve the repression.

2. How can the actively transcribing polymerase pass through arrays of nucleosomes?

Most genes (with the probable exception of ribosomal genes) carry nucleosomes even when being actively transcribed. Furthermore, the polymerase seems to move quite rapidly along the chromosome. Current evidence favors temporary displacement of nucleosomes during transcription, but the issue is far from settled. One factor that may play a role in such displacement is the development of positive superhelical torsion ahead of a moving polymerase. A polymerase moving along a helical template must either continually rotate about the DNA or build up positive supercoils ahead (overwinding) to compensate for the unwinding it is doing. Such torsion would tend to destabilize nucleosomes, because they contain negatively wrapped DNA.

See also: [Eukaryotic Transcription](#), [Higher Order Chromatin Structure](#)

INTERNET LINKS:

1. [The Role of Chromatin Structure in Transcription](#)
 2. [The Collaboration of Proteins During Replication](#)
 3. [Globin Gene Server](#)
-

Table 28.7



Prokaryotic Factor	Eukaryotic Factor	Function
Initiation Factors		
IF1	eIF1, eIF1A	Prepare mRNA for proper attachment to ribosome
IF2	eIF2, eIF2B	} Helps bind Met-tRNA
IF3	eIF3, eIF4C	
	eIF4A, eIF4B, eIF4F	As eIF1, eIF1A
	eIF5	Helps dissociate eIF2, eIF3, eIF4C
	eIF6	Helps dissociate 60S subunit from inactive ribosomes
Elongation Factors		
EF-Tu	eEF1 α	Delivery of aminoacyl tRNA to ribosomes
EF-Ts	eEF1 $\beta\gamma$	Aids in recycling factor above
EF-G	eEF2	Translocation factor
Release Factors		
RF1	eRF	} Release of complete polypeptide chain
RF2		
RF3		

Figure 28.35: Initiation of translation in eukaryotes.

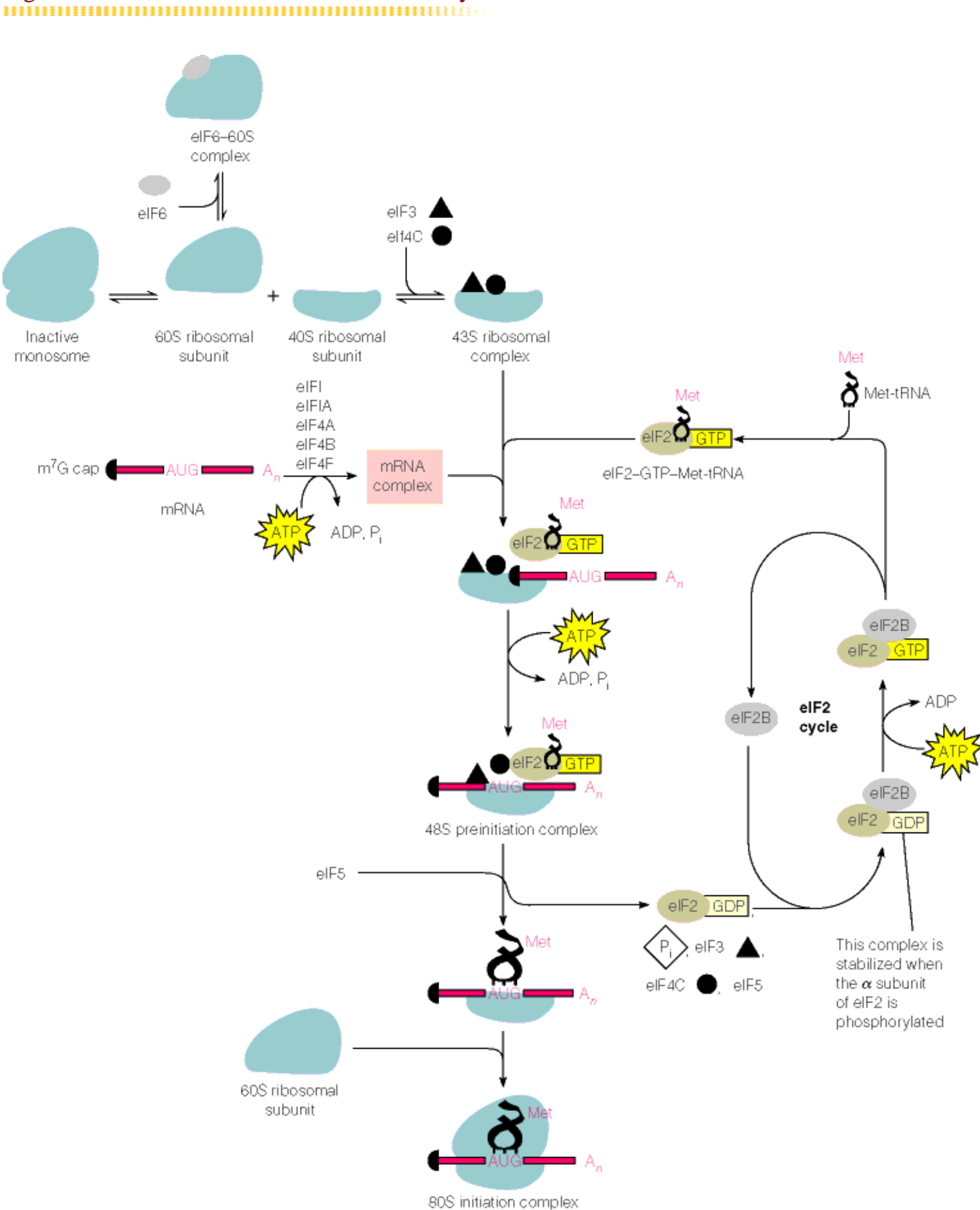

80S initiation complex

Pactamycin

Pactamycin is an antibiotic that inhibits translation.

See also: [Antibiotic Inhibition of Translation](#), [Translation Overview](#), [Structure of tRNAs](#), [Eukaryotic vs Prokaryotic Translation](#)

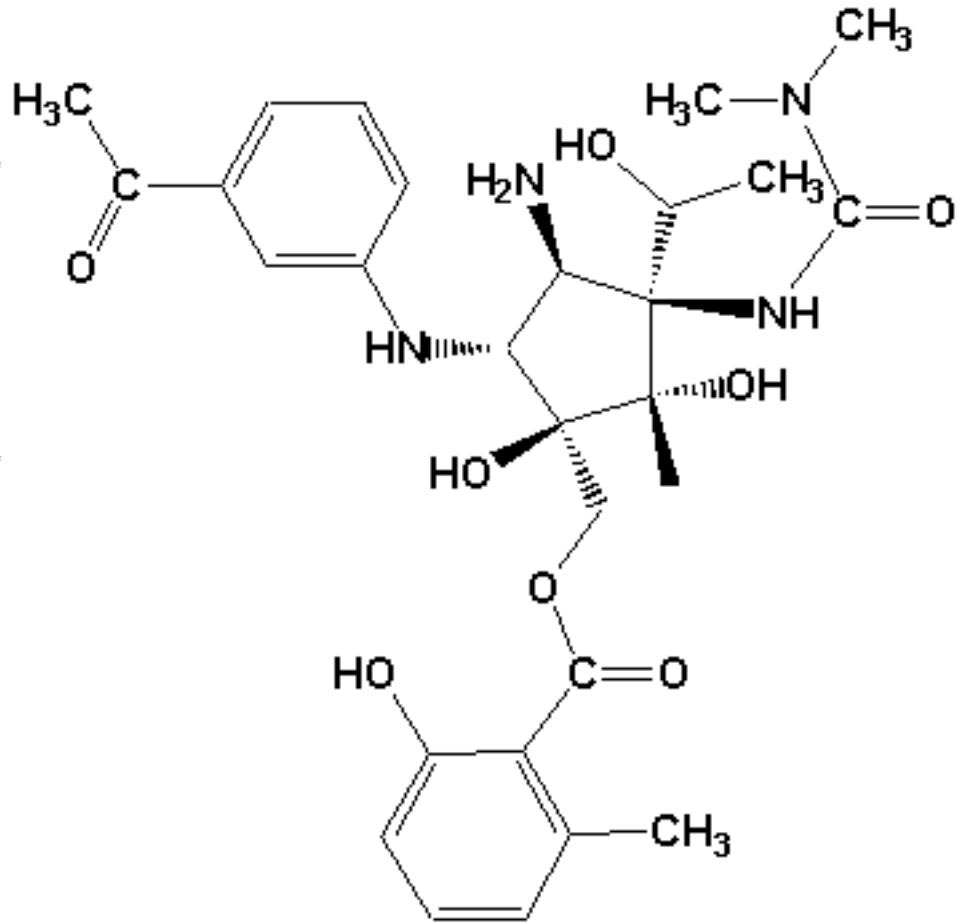

Pactamycin

Antibiotic Inhibition of Translation

Figure 27.28 shows a few of the important **antibiotics** that act by **inhibiting translation**. Many translation-inhibiting **antibiotics** work selectively on prokaryotic organisms because the process of translation is sufficiently different in them than it is in humans. Thus, these compounds can be used to treat bacterial infections with minimal side effects to humans.

Microorganisms develop resistance to many **antibiotics** often through acquisition of a particular "resistance gene." When bacteria carrying a resistance gene are treated with the drug, only resistant bacteria will grow.

Actions of the common **antibiotics** are as follows:

Tetracycline - Inhibits binding of aminoacyl **tRNAs** to the **ribosome** and thereby blocks continued translation.

Streptomycin - Interferes with normal pairing between aminoacyl tRNAs and message **codons**, causing misreading, and thereby producing aberrant proteins.

Erythromycin - Binds to a specific site on the 23S RNA and blocks elongation by interfering with the translocation step.

Chloramphenicol - Blocks elongation, apparently by acting as competitive inhibitor for the peptidyltransferase complex. The amide link in the molecule resembles a peptide bond.

Puromycin - Causes premature chain termination. Part of the molecule resembles the 3' end of the aminoacylated tRNA. It will enter the A site and transfer to the growing chain, causing premature chain release.

See also: [Initiation of Translation](#), [Elongation of Translation](#), [Termination of Translation](#)

Figure 27.28: Some antibiotics that act by interfering with protein biosynthesis.

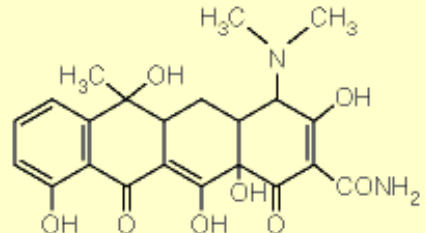

Tetracycline: Inhibits the binding of aminoacyl tRNAs to the ribosome and thereby blocks continued translation

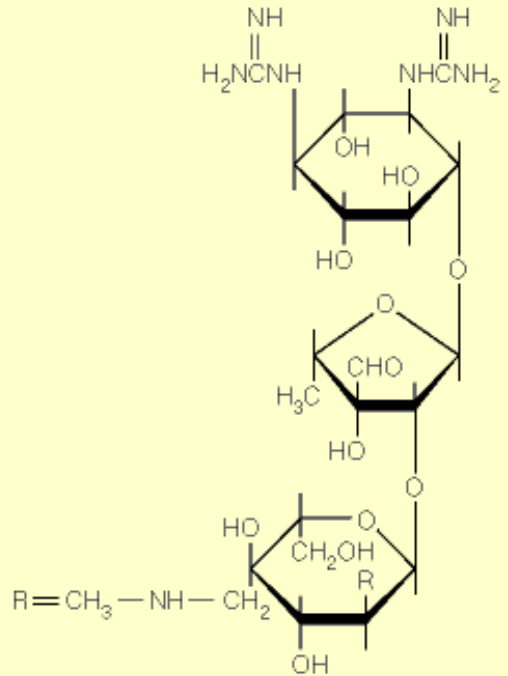

Streptomycin: Interferes with normal pairing between aminoacyl tRNAs and message codons, causing misreading, and thereby producing aberrant proteins

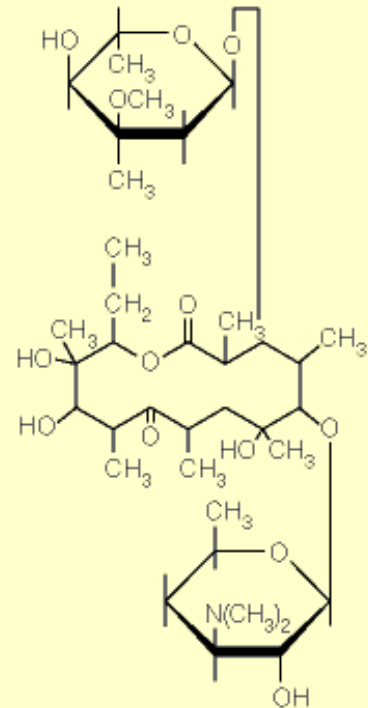

Erythromycin: Binds to a specific site on the 23S RNA and blocks elongation by interfering with the translocation step

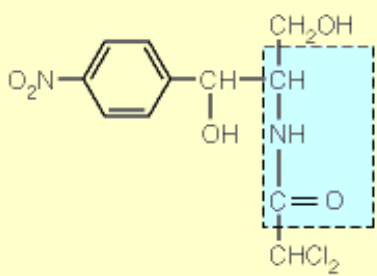

Chloramphenicol: Blocks elongation, apparently by acting as competitive inhibitor for the peptidyltransferase complex. The amide link (in blue) resembles a peptide bond

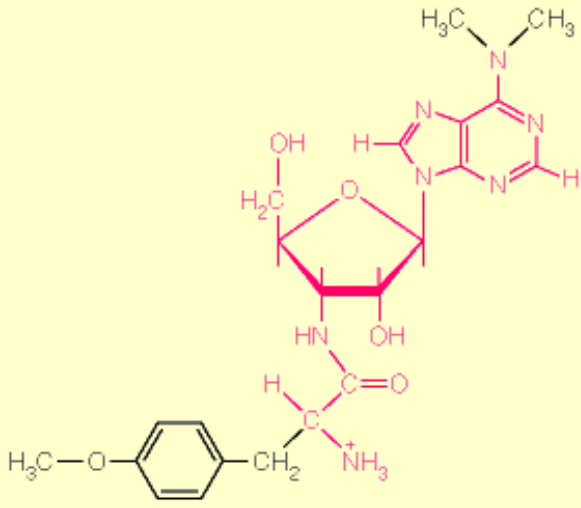

Puromycin: Causes premature chain termination. The red portion of the molecule resembles the 3' end of the aminoacylated tRNA. It will enter the A site and transfer to the growing chain, causing premature chain release

Tetracycline

Tetracycline is an antibiotic that acts by inhibiting binding of aminoacyl **tRNAs** to the **ribosome** and thereby blocking continued translation.

See also: [Antibiotic Inhibition of Translation](#)

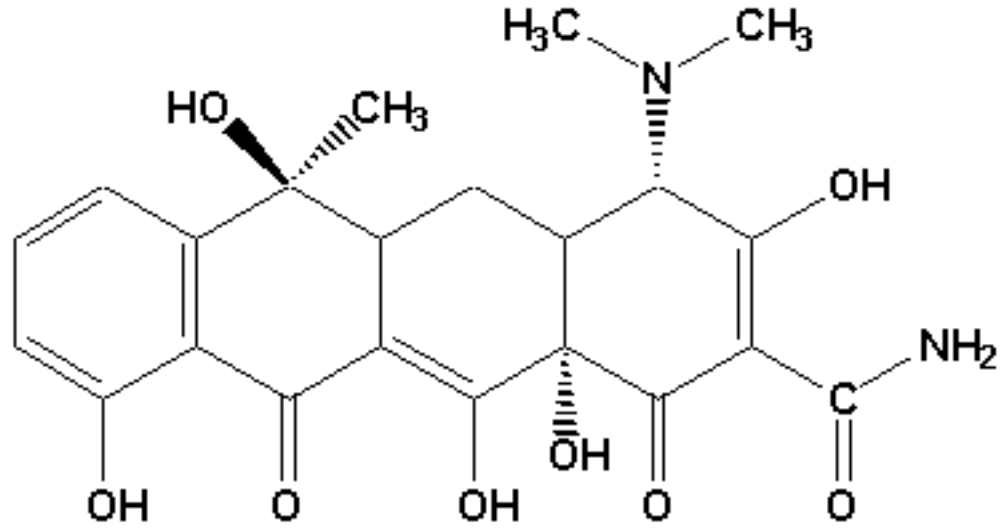

Tetracycline

Streptomycin

Streptomycin is an antibiotic that interferes with normal pairing between aminoacyl **tRNAs** and message **codons**, causing misreading, and thereby producing aberrant proteins during translation.

See also: [Antibiotic Inhibition of Translation](#)

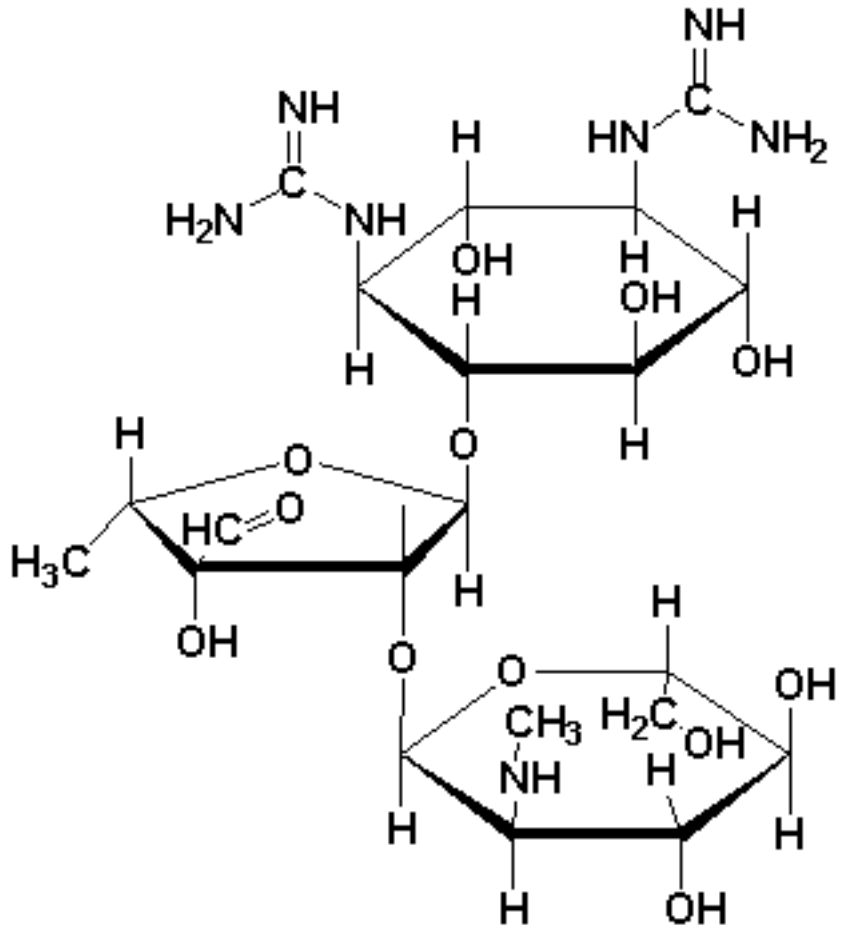

Streptomycin

Erythromycin

Erythromycin is a polyketide antibiotic made via a modification of the fatty acid synthesis pathway in the bacterium *Saccharopolyspora erythraea*. It acts by binding to a specific site on the 23S rRNA and blocking elongation by interfering with the translocation step.

See also: [Polyketides](#), [Fatty Acid Biosynthesis](#), [Antibiotic Inhibition of Translation](#), [Elongation of Translation](#)

INTERNET LINKS:

1. [Polyketide Biosynthesis](#)
 2. [3D Model of Erythromycin](#)
(requires Chime)
-

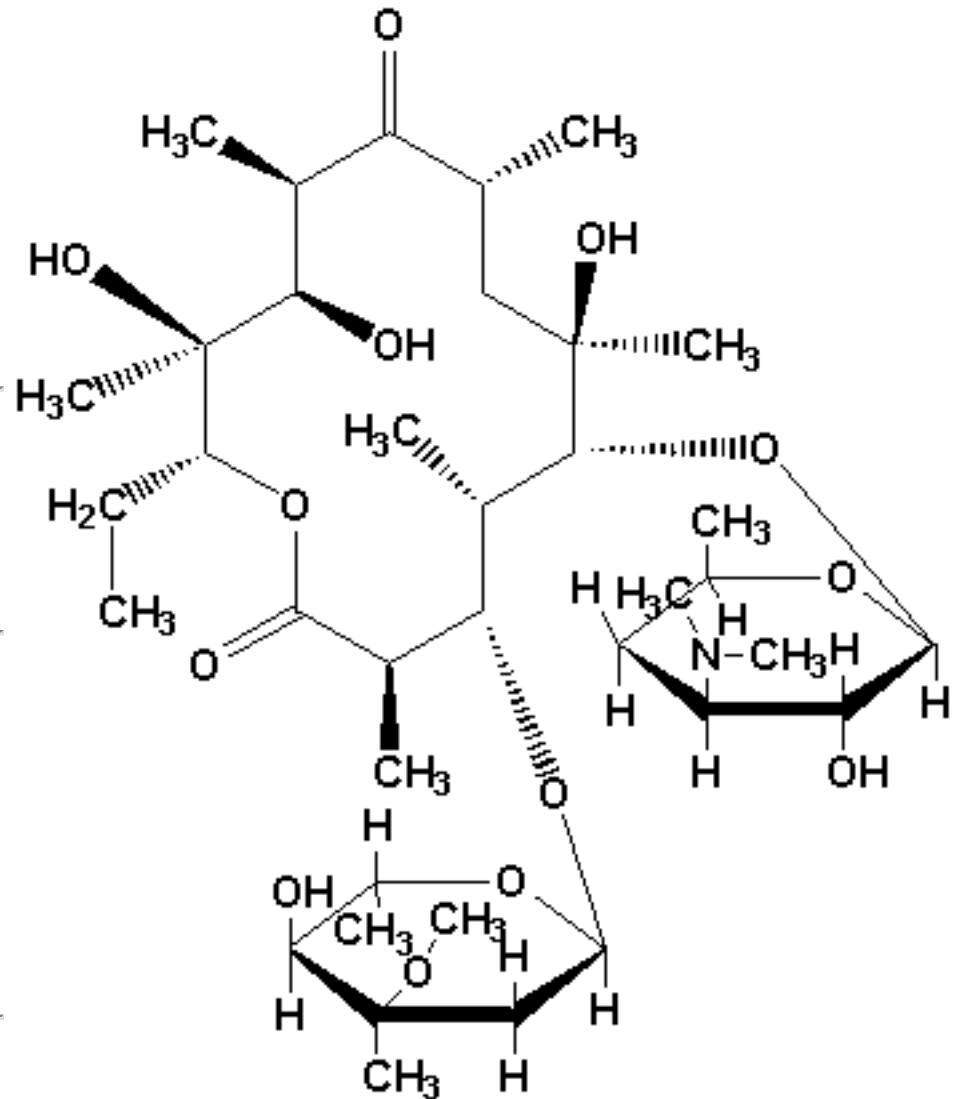

Erythromycin

Polyketides

Polyketides constitute a class of antibiotics which are made in pathways like fatty acid biosynthesis, but in which one or more of the activities are missing ([Figure 18.35](#)). Example polyketides include [erythromycin](#) and [oxytetracycline](#).

See also: [Polyketide Synthesis](#), [Palmitate Synthesis from Acetyl-CoA](#)

INTERNET LINKS:

1. [Polyketide Biosynthesis](#)
 2. [3D Model of Erythromycin](#) (requires Chime)
-

Figure 18.35: Biosynthetic route leading to erythromycin and related antibiotics.

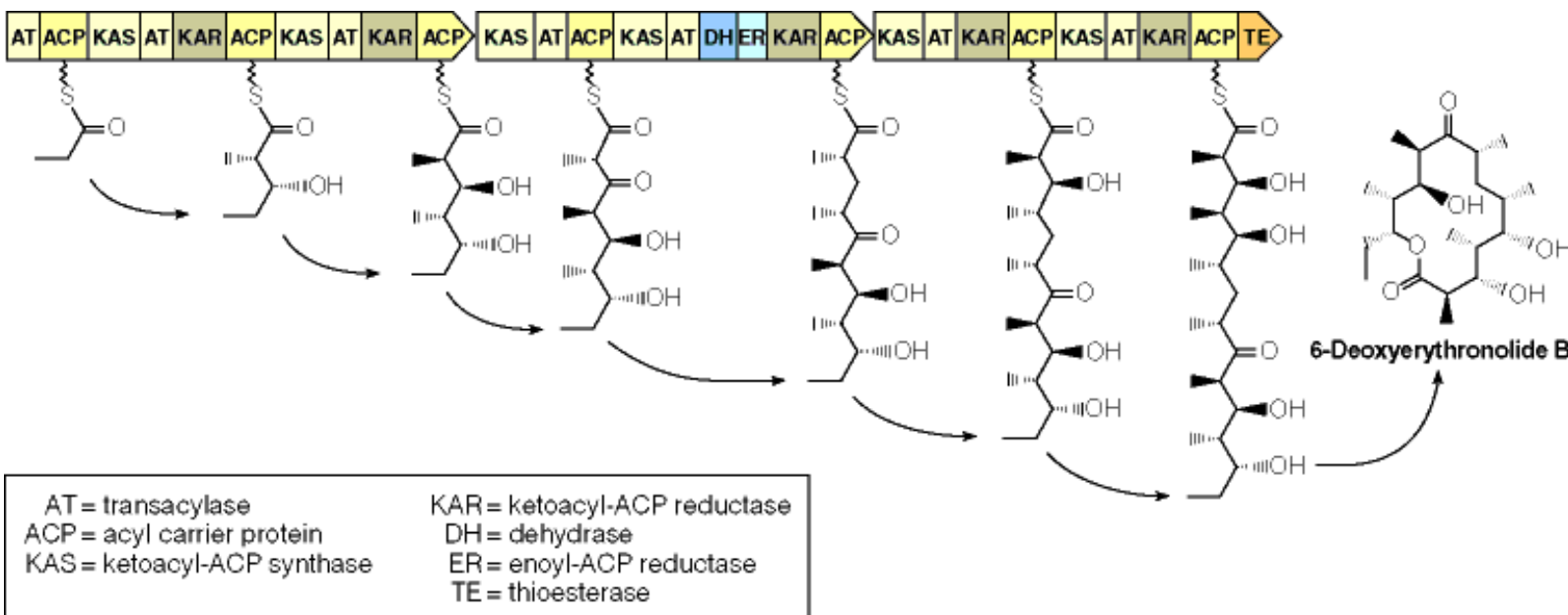

Modified from R. L. Rawls, Chem. Eng. News (1998) 76(10), pp. 29-32. © 1998 American Chemical Society.

Oxytetracycline

Oxytetracycline is an antibiotic polyketide synthesized by the bacterium *Saccharopolyspora erythraea*.

See also: [Polyketides](#), [Erythromycin](#), [Polyketide Synthesis](#)

INTERNET LINKS:

1. [Polyketide Biosynthesis](#)
 2. [3D Model of Erythromycin](#) (requires Chime)
-

Polyketide Synthesis

Polyketides are a class of antibiotics found in bacteria and fungi. [Erythromycin](#) and [oxytetracycline](#) are examples. The pathway for **polyketide synthesis** contains part of the fatty acid biosynthesis pathway, except that one or more of the enzymes are missing at various points in the pathway ([Figure 18.35](#)). This leads to a diverse set of products containing internal hydroxyls and ketone groups.

See also: [Polyketides](#), [Erythromycin](#), [Oxytetracycline](#), [Fatty Acid Biosynthesis Strategy](#)

INTERNET LINKS:

1. [Polyketide Biosynthesis](#)
 2. [3D Model of Erythromycin](#) (requires Chime)
-

Chloramphenicol

Chloramphenicol is an antibiotic that blocks elongation of translation, apparently by acting as competitive inhibitor for the peptidyltransferase complex. The amide link in the molecule resembles a peptide bond.

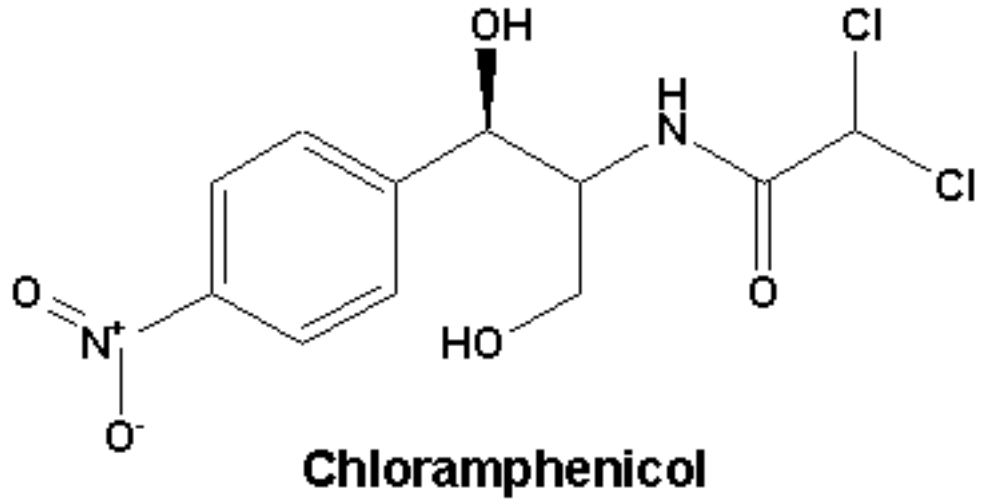

See also: [Antibiotic Inhibition of Translation](#), [Elongation of Translation](#)

Puromycin

Puromycin is an antibiotic that causes premature chain termination during translation. Part of the molecule resembles the 3' end of the aminoacylated **tRNAs**. It will enter the A site and transfer to the growing chain, causing premature chain release.

See also: [Antibiotic Inhibition of Translation](#), [Translation Overview](#), [Structure of tRNAs](#)

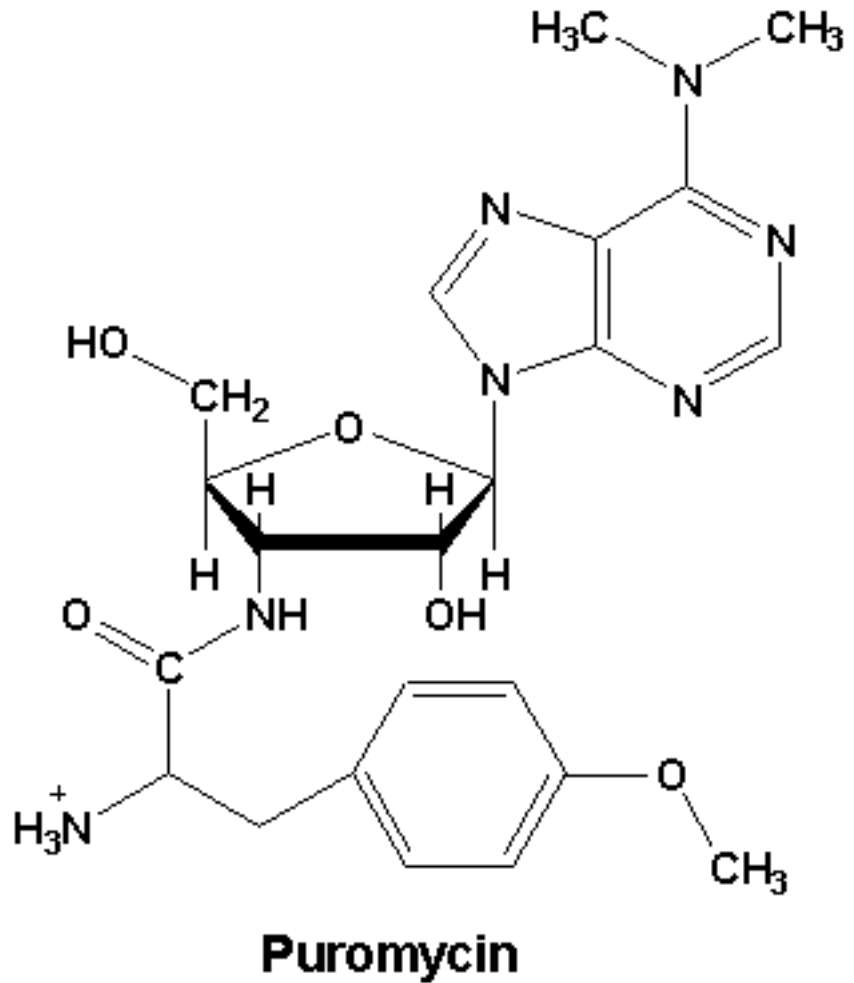
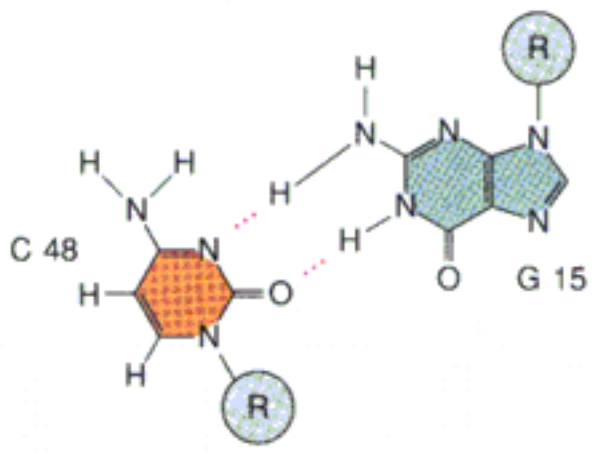
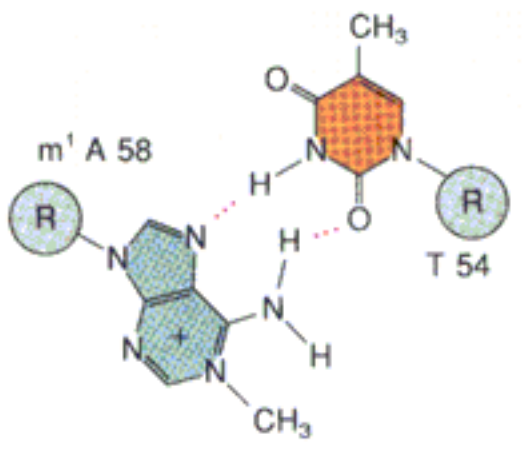

Figure 27.9: Unusual base pairings in tRNA.



(a)



(b)

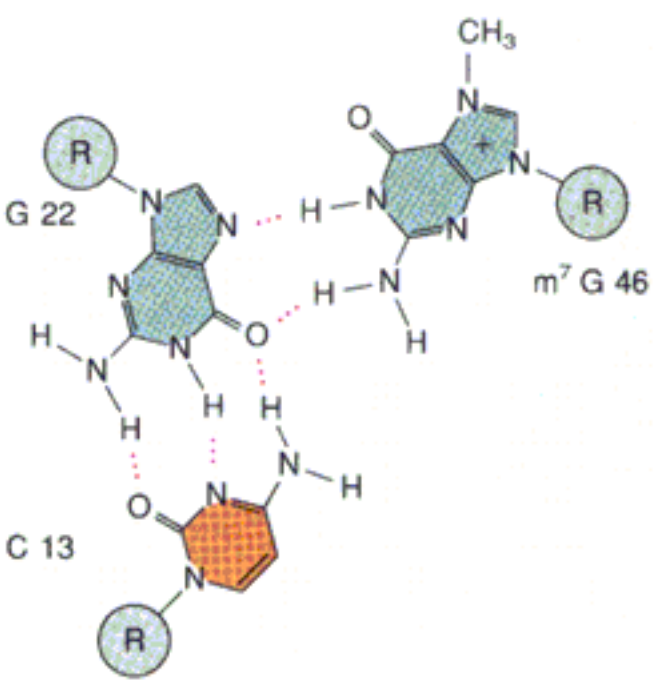

(c)

(c)

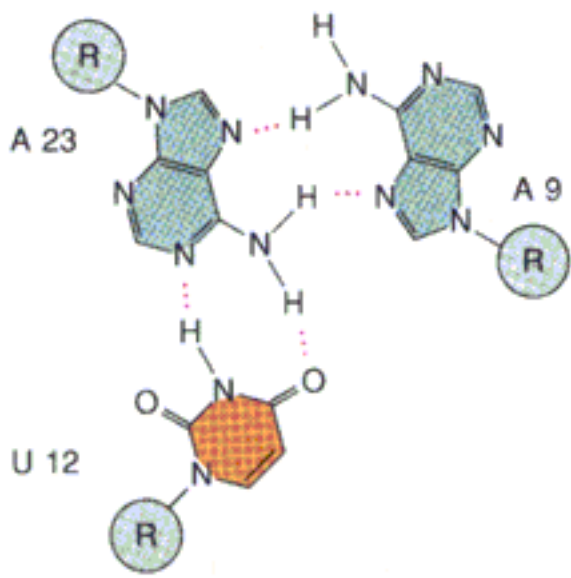

(d)

Posttranscriptional Processing of rRNA and tRNA

Both **ribosomal RNAs (rRNAs)** and **transfer RNAs (tRNAs)** are synthesized in the form of larger transcripts (pre-rRNA and pre-tRNA, respectively), which undergo cleavage at both ends of the transcript, *en route* to becoming mature RNAs. The total amount of DNA encoding these RNAs amounts to less than 1% of the *E. coli* genome, but because of the instability of **mRNA** (which is encoded by the remaining 99%), **rRNA** and **tRNA** constitute about 98% of the total RNA in a bacterial cell.

rRNA Processing - The *E. coli* genome contains seven different operons for rRNA species. Each one encodes, sequences in a single transcript, for one copy each of 16S, 23S, and 5S **rRNAs** ([Figure 26.41](#)). Because the three species are used in equal amounts, the logic of this organization is apparent. Less easy to explain is that each transcript also includes sequences for one to four **tRNA** molecules. Because **rRNAs** and **tRNAs** are all used in protein synthesis, the interspersion of **rRNA** and **tRNA** sequences may represent a means of coordinating the rates of synthesis of these RNAs.

The initial transcript from each **rRNA** operon is a short-lived RNA molecule of 30S ([Figure 26.41](#)). Abnormal accumulation of this species in bacterial strains defective in RNase III first suggested a role for this enzyme in **rRNA** processing. In fact, one double-strand cut in each of two giant stem-loop regions releases precursors to 16S and 23S **rRNAs**, and the same probably occurs for 5S **rRNA**. Further maturation steps require the presence of particular ribosomal proteins, which begin to assemble on the precursor RNAs while transcription is still in progress. The embedded **tRNA** sequences are processed to give mature **tRNAs**, along the same routes used for other **tRNA** species.

tRNA Processing - Aside from the **tRNAs** embedded in pre-rRNA transcripts, the other **tRNAs** are synthesized in transcripts that contain one to seven **tRNAs** each, all surrounded by lengthy flanking sequences. The maturation steps are summarized in [Figure 26.42](#), using the well-studied case of the *E. coli* tyrosine tRNA species (**tRNA Tyr**) as an example. The steps in the process can be summarized as follows:

1. Maturation starts with an endonuclease that cleaves at a stem - loop structure on the 3' side of the **tRNA** sequence.
2. Ribonuclease D carries out exonucleolytic cleavage to a point two nucleotides removed from the CCA sequence at the 3' end.
3. The 5' end is created by ribonuclease P, which cleaves to leave a phosphate on the 5' terminal G. This enzyme creates the 5' terminus of all **tRNA** molecules. It is not clear what structural features are recognized by RNase P, for different sequences are contained in the cleavage sites. Ribonuclease P consists of one RNA molecule of 377 nucleotides and one protein molecule with Mr of about 20,000. Both components are necessary for full catalytic activity, but under nonphysiological conditions the RNA molecule alone can

catalyze accurate cleavage. Thus, ribonuclease P is a ribozyme, a member of the class of catalytic RNAs.

4. After the proper 5' terminus has been created, ribonuclease D removes the remaining two nucleotides from the 3' end. Should excessive "nibbling" occur through faulty control of RNase D activity, there is an enzyme that will restore the CCA end to any **tRNA** in a nontranscriptive fashion. This enzyme specifically recognizes the 3' terminus of tRNAs that lack the CCA end and catalyzes sequential reactions with a CTP, another CTP, and an ATP.

5. Creation of the modified bases common to **tRNAs** occurs at the final stage, including methylations, thiolations, reduction of uracil to dihydrouracil, and so forth. In the specific example of [Figure 26.42](#), the modifications include formation of two pseudouridines, one [2-isopentenyladenosine](#), one [O²-methylguanosine](#), and one [4-thiouridine](#).

An additional posttranscriptional process, namely intron splicing, is almost exclusively confined to eukaryotes (see [here](#)).

See also: [mRNA Turnover](#), [Ribozymes](#) (from Chapter 11), [Structure of tRNAs](#) (from Chapter 27), [Structure of Prokaryotic mRNAs](#) (from Chapter 27)

INTERNET LINKS:

1. [Small RNA Database](#)
 2. [The RNA World](#)
 3. [RNA Modification Database](#)
 4. [tRNA Sequence Database](#)
 5. [rRNA Database](#)
 6. [5S rRNA Homepage](#)
-

Figure 26.42: Modification steps (1-4) that occur in maturation of *E. coli* tRNA^{Tyr} from its transcript and modified bases (5) seen in the mature tRNA.

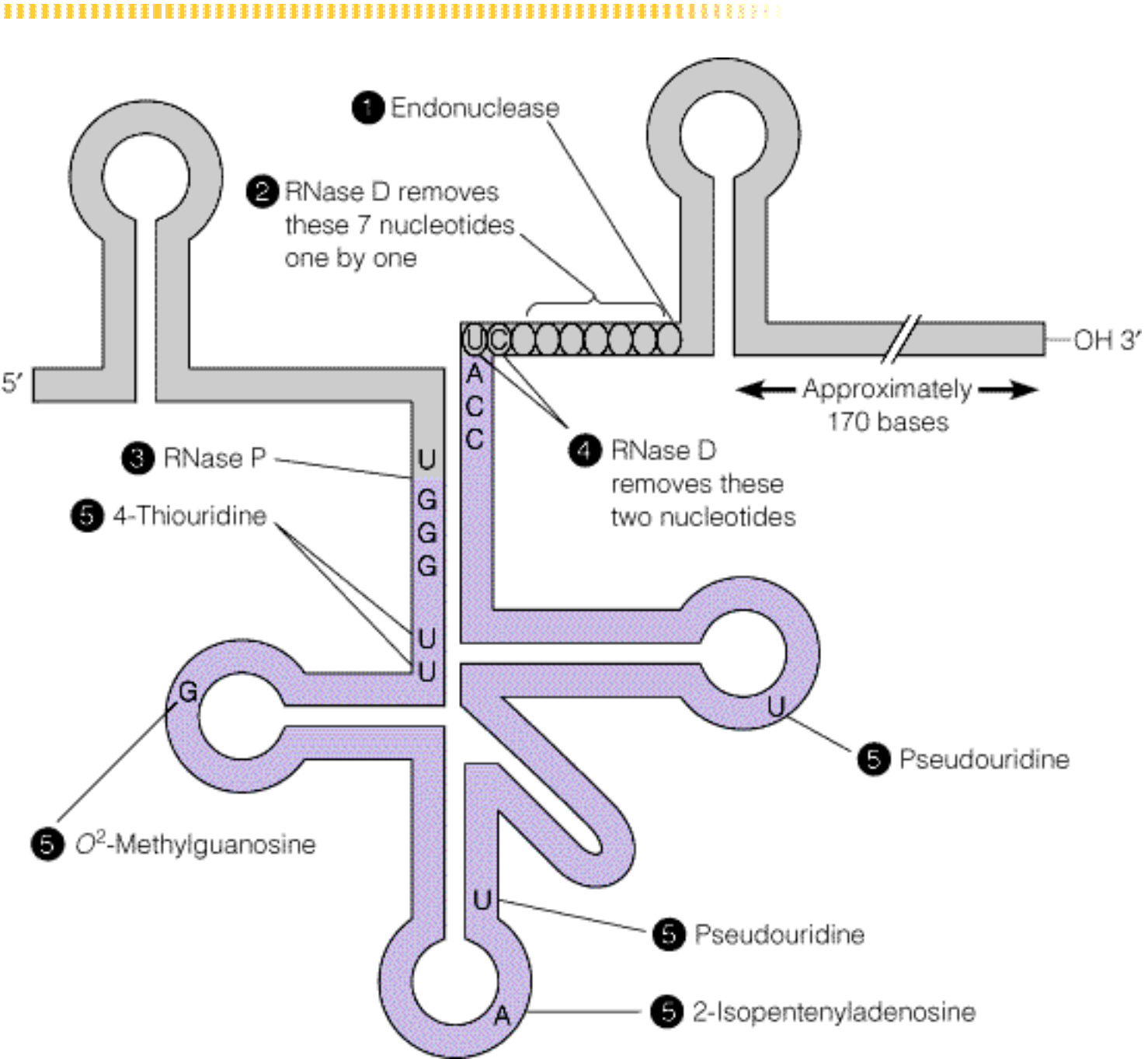

2-Isopentenyladenosine

2-Isopentenyladenosine is a modified nucleoside found in **tRNAs**.

See also: [Posttranscriptional Processing of rRNA and tRNA](#)

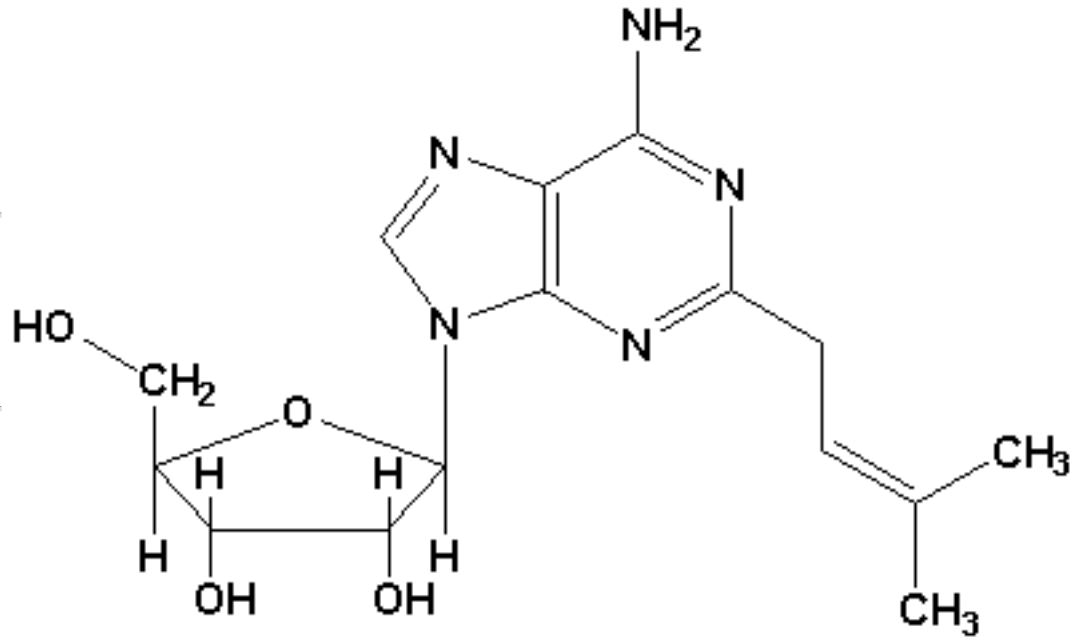

2-Isopentenyladenosine

O



O²-Methylguanosine is a modified nucleoside found in tRNAs.

See also: Posttranscriptional Processing of rRNA and tRNA

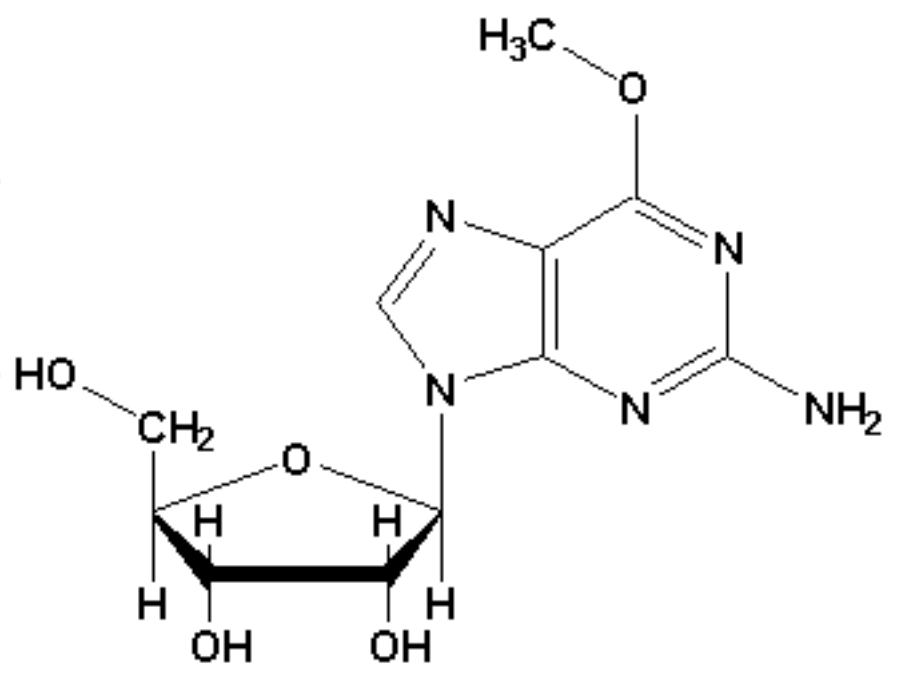

O²-Methylguanosine

4-Thiouridine

4-Thiouridine is a modified nucleoside found in [tRNAs](#).

See also: [Posttranscriptional Processing of rRNA and tRNA](#)

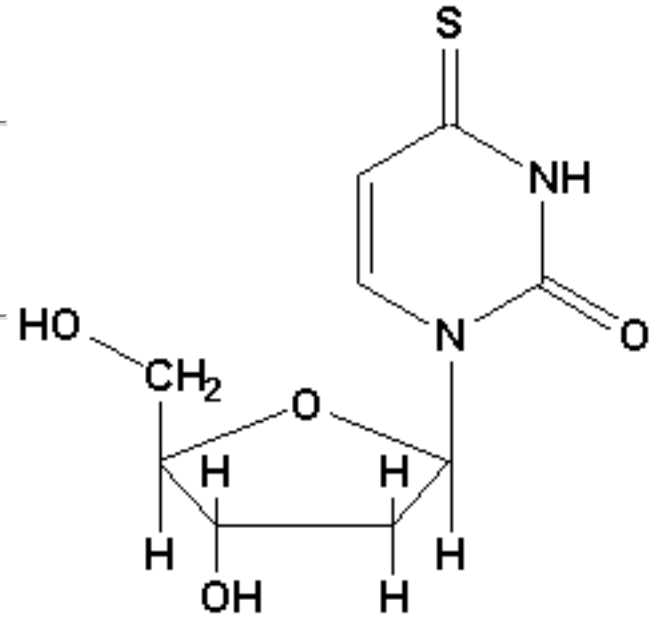

4-Thiouridine

mRNA Turnover

A major aspect of messenger RNA metabolism in eukaryotes is the events occurring after transcription, events that are necessary for messages to move from the nucleus to the cytosol where translation occurs (see [here](#)). In prokaryotes, by contrast, [mRNAs](#) are used in protein synthesis directly. In fact, a nascent mRNA serves as a template for translation while still in the process of being synthesized.

mRNA degradation - The major posttranscriptional event in the metabolism of prokaryotic mRNA is its own degradation, which in most cases is quite rapid. A few bacterial mRNAs, notably those encoding outer membrane proteins, are long-lived; however, most bacterial messages have half-lives of only 2 to 3 minutes. This short life span means that genes that are expressed must be transcribed continuously and that most mRNA molecules are translated only a few times. Although this might seem energetically wasteful, it is consistent with prokaryotic lifestyles, which necessitate rapid adaptation to environmental changes. There is a selective advantage to bacteria for expressing the genes for lactose utilization only when an inducer is present. By the same token, it would be wasteful for the cell to continue producing these proteins after lactose was exhausted. Rapid degradation of *lac* mRNA ensures that the energetically wasteful synthesis of these proteins will cease soon after the need for the proteins is gone.

Mechanism of degradation - Surprisingly little is known about the pathway of degradation. There are probably overlapping mechanisms, involving hydrolysis by nucleases and phosphorolysis by polynucleotide phosphorylase. It is known that degradation starts from the 5' end, which is important because translation also starts from the 5' end. If degradation were to start from the 3' end, a ribosome starting from a 5' end might never reach an intact 3' end. There is reason to think that mRNA degradation sometimes starts with the action of ribonuclease III, an enzyme specific for duplex RNA, which could cleave in stem-loop structures and create sites for exonucleolytic attack. RNase III is actually involved in the maturation of certain phage mRNAs as they undergo posttranscriptional processing, but this involvement is not known to occur with bacterial mRNAs.

An additional posttranscriptional process, called intron splicing, is almost exclusively confined to eukaryotes (see [here](#)).

See also: [Posttranscriptional Processing of rRNA and tRNA](#), [Processing of mRNA](#)

Formation of Aminoacylated tRNAs

Amino acids are linked to **tRNA** molecules by a covalent bond between the carboxyl group of the **amino acid** and a ribose hydroxyl group of the 3' adenosine of the acceptor stem of the tRNA. A **tRNA** molecule bonded to its amino acid is said to be "**aminoacylated**" and the enzymes that catalyze this reaction are called aminoacyl-tRNA synthetases.

E. coli has 20 **aminoacyl-tRNA synthetases**, each of which recognizes one particular amino acid and one or more tRNAs. There are two general classes of **aminoacyl-tRNA synthetases** (I and II). They differ in amino acid sequence, the ways in which they bind their cognate **tRNAs**, and in their quaternary structures.

Figure 27.10 shows the sequence of reactions that covalently links an amino acid to its **tRNA**. The reaction proceeds via an aminoacyl adenylate intermediate, and **AMP** is released as the amino acid is joined to the proper **tRNA**. When the amino acid is attached, the amino acid is referred to as "charged."

Some bacteria employ an unusual pathway in which glutamine is incorporated into gln-tRNA without a glutamine-specific **aminoacyl tRNA-synthetase**. In this case, the synthetase for **glutamate** is used and **glutamine** is created by transamination, as follows:

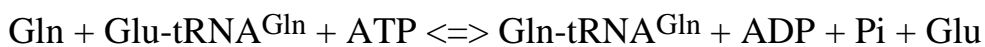
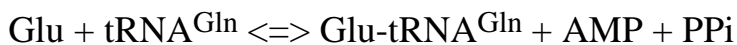

How is the proper **tRNA** recognized by the **aminoacyl-tRNA synthetase**? Interestingly, the **anticodon** can be all of, part of, or no part of the recognition site for the enzyme. As a result, other regions of the **tRNA** besides the anticodon must be involved in identifying a tRNA. **Figure 27.11** shows the identity elements known for class I and class II tRNAs.

Aminoacyl tRNA-synthetases have a proofreading ability to double-check that an amino acid is linked with its proper tRNA. The proofreading ability of the enzyme and other proofreading steps (see [here](#)) in translation reduce the error frequency to less than 1 in 10,000.

See also: [Structure of tRNAs](#), [The Genetic Code](#), [Translation Overview](#)

INTERNET LINK: [tRNA Synthetase Image](#)

Amino Acyl tRNA Synthetases

Amino acyl tRNA synthetases are enzymes that catalyze the covalent joining of an amino acid to its specific tRNA molecule. *E. coli* has 20 **aminoacyl-tRNA synthetases**, each of which recognizes one particular amino acid and one or more tRNAs. The two general classes of **aminoacyl-tRNA synthetases** (I and II) differ in amino acid sequence, the ways in which they bind their cognate tRNAs, and in their quaternary structures.

Figure 27.10 shows the sequence of reactions that covalently links an amino acid to its tRNA. The reaction proceeds via an aminoacyl adenylate intermediate, and **AMP** is released as the amino acid is joined to the proper tRNA.

How is the proper tRNA recognized by the **aminoacyl-tRNA synthetase**? Interestingly, the **anticodon** can be all of, part of, or no part of the recognition site for the enzyme. As a result, other regions of the tRNA besides the anticodon must be involved in identifying a tRNA. **Figure 27.11** shows the identity elements known for class I and class II tRNAs.

Aminoacyl tRNA-synthetases have a proofreading ability to double-check that an amino acid is linked with its proper tRNA. The proofreading ability of the enzyme and other proofreading steps (see [here](#)) in translation reduce the error frequency to less than 1 in 10,000.

See also: [Formation of Aminoacylated tRNAs](#)

INTERNET LINKS: [Amino Acyl tRNA Synthetase Data Bank](#)

Figure 27.10: Formation of aminoacyl tRNAs by aminoacyl tRNA synthetase.

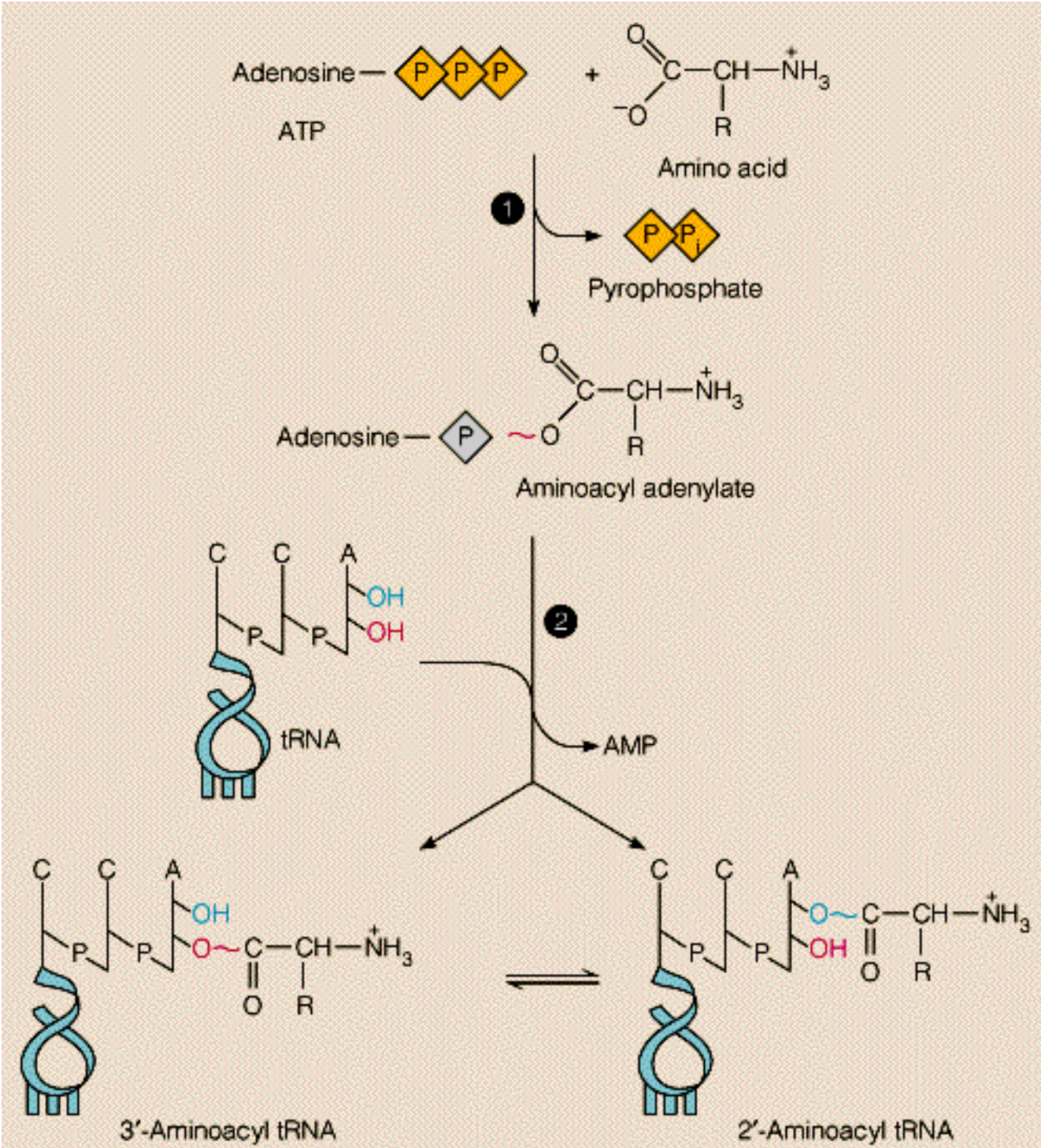
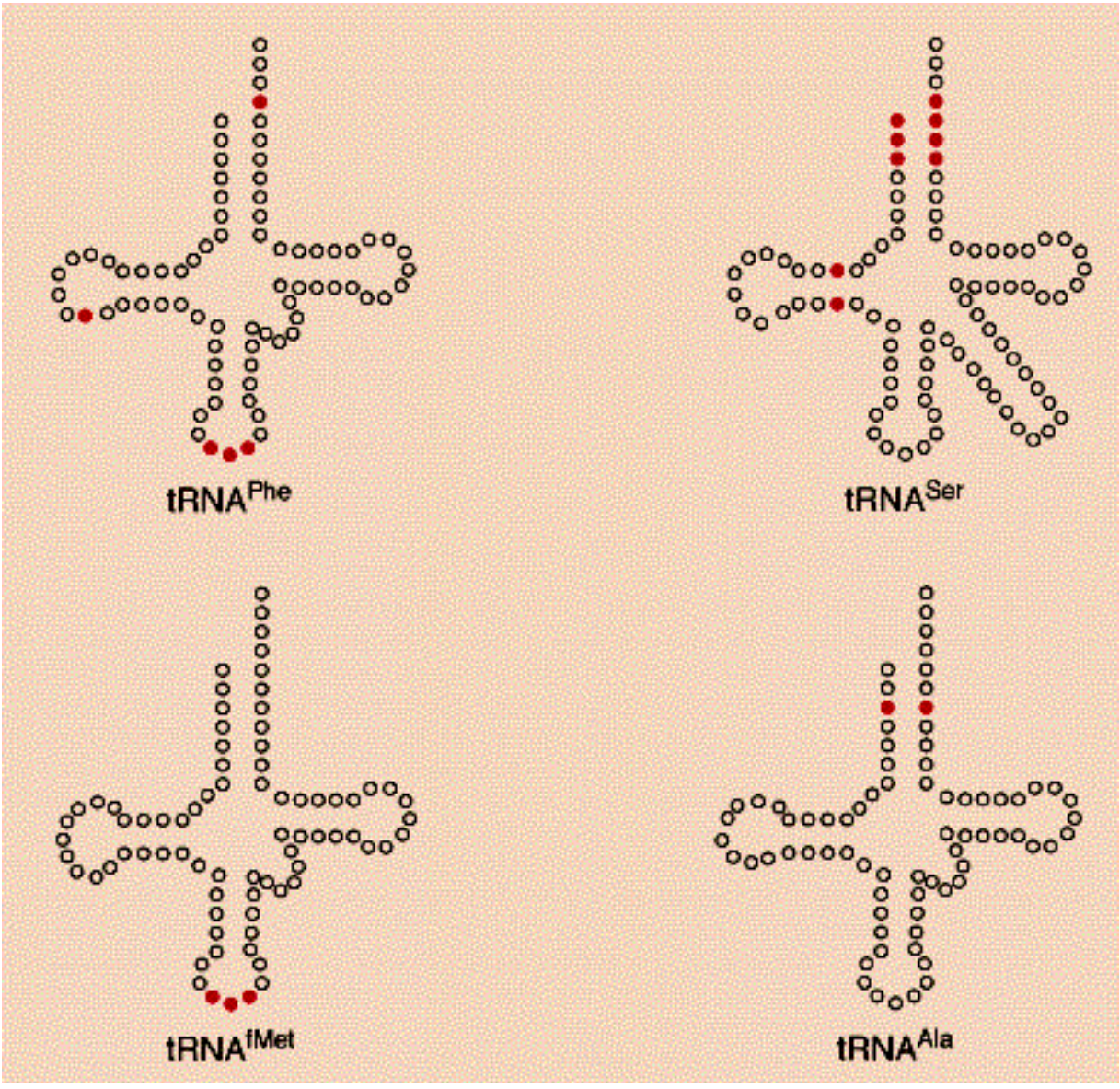

Figure 27.11: Major "identity elements" in some tRNAs.



Adapted from L. Schulman and J. Abelson, Science (1988) 240:1591-1592.

Cycloheximide

Cycloheximide is an inhibitor of eukaryotic translation.

See also: [Eukaryotic vs Prokaryotic Translation](#)

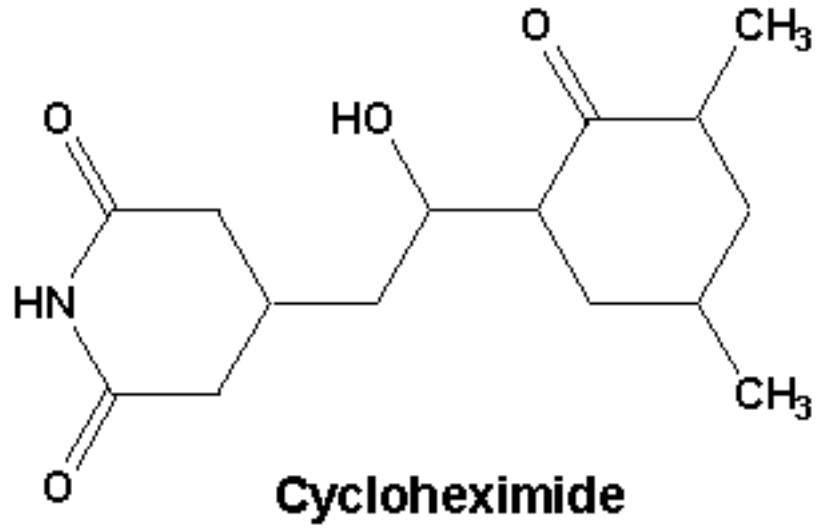
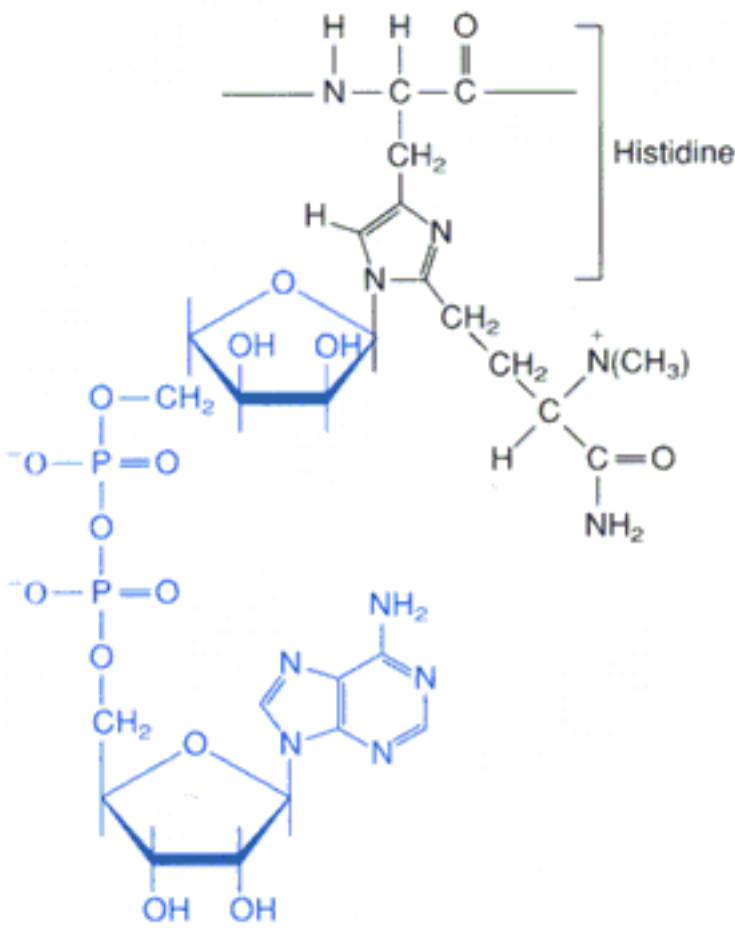

Figure 28.36: ADP-ribosylated diphthamide derivative of histidine in eEF2.



Control of Eukaryotic Translation

Prokaryotes do not seem to make extensive use of **control at the translational level**, whereas eukaryotes use **translational control** much more widely. In part, translational control in eukaryotes occurs at the **mRNA** level. It may involve the sequestering of specific mRNAs by combining with specific mRNA-binding proteins and/or rapid degradation of mRNA so that they do not persist in inappropriate phases of the **cell cycle**. Other **translational controls** include the phosphorylation of factors involved in translation, as listed below:

1. **Globin synthesis control** - Synthesis of globin in reticulocyte cells is pointless unless there is sufficient heme present. Reticulocyte cells contain a protein kinase called **heme-controlled inhibitor (HCI)** ([Figure 28.37](#)). In the presence of adequate heme levels, the kinase is inactive, but if **heme** levels fall, however, **HCI** becomes activated and specifically phosphorylates the initiation factor eIF2, causing the complex between eIF2 and eIF2B to become unusually stable. The result is that all of the eIF2 is tied up and can no longer be recycled for new initiation. Hence, protein synthesis is halted, and no more globin is made until heme supplies are again adequate.

2. **Interferon Action** - Anti-viral agents called **interferons** are cellular glycoproteins produced in response to virus infections. In addition to stimulating mRNA degradation, **interferons** induce the synthesis of a protein kinase that phosphorylates eIF2 (like HCI above) and destabilizes the eIF2-eIF2B complex, inhibiting protein synthesis in the process.

Phosphorylation of initiation factors appears to be a general method for **translational control** in eukaryotes.

See also: [Eukaryotic vs Prokaryotic Translation](#)

INTERNET LINKS:

1. [Globin Gene Server](#)
 2. [Evolution of Interferon Therapy](#)
-

Figure 28.37: Regulation of translation in erythropoietic cells by heme levels.

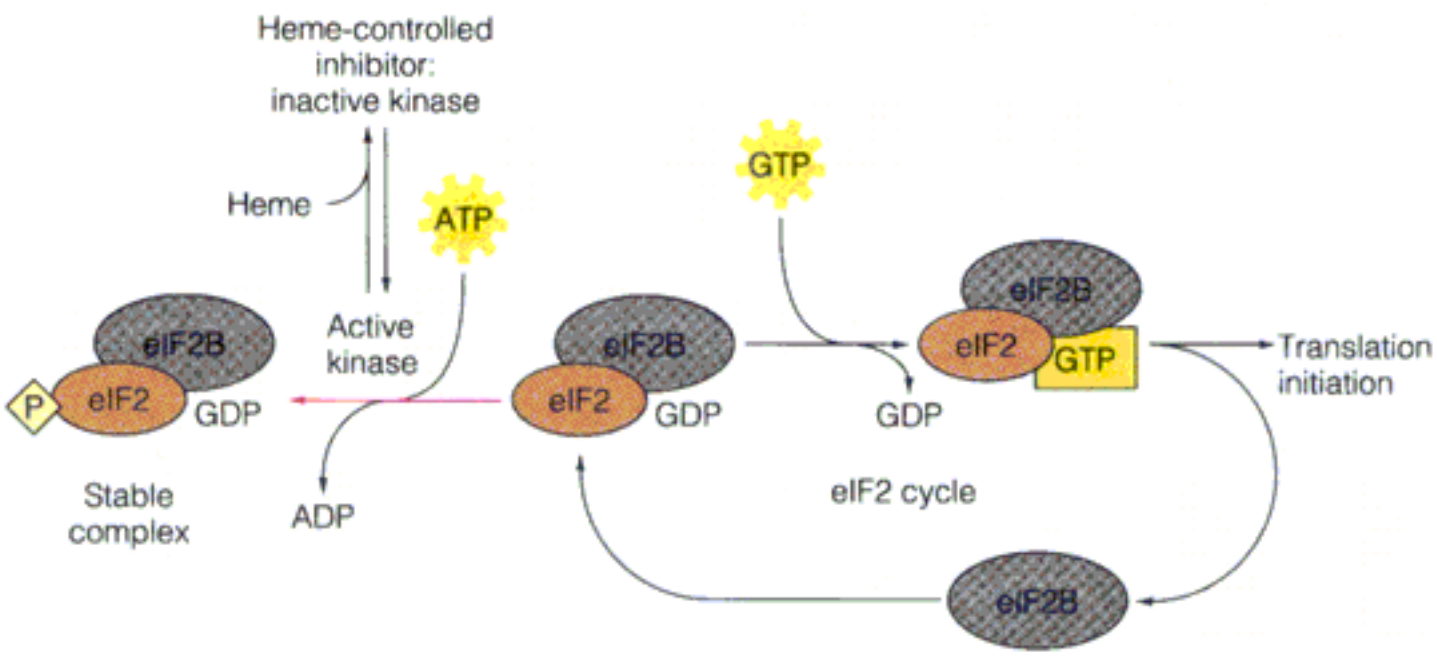

Signal Transduction Agonists and Antagonists

A hormone **agonist** is an analog of the hormone that binds productively to a receptor and mimics the action of the endogenous hormone. An **agonist** is comparable to an alternative substrate for an enzyme. Because its binding to a receptor is productive; that is, it evokes a metabolic response comparable to that of binding the hormone. By contrast, a hormone **antagonist** binds to receptors but does not provoke the normal biological response. An **antagonist** is to a receptor as a competitive inhibitor is to an enzyme; that is, both **antagonists** and competitive inhibitors compete with a normal ligand (hormone or substrate, respectively) for binding to a specific site on a protein and, by so binding, inhibit a normal biological process.

Agonists and **antagonists** have been useful in studies of the stereochemistry of binding sites on receptors. In turn, these investigations are useful in drug design, with a goal of activating or inactivating certain classes of receptors. The **agonist** [isoproterenol](#) is used to treat asthma, because it mimics the effects of [catecholamines](#) in relaxing bronchial muscles in the lung; it does so by interacting with one specific class of adrenergic receptors (so-called because they bind adrenaline, the old name for **epinephrine**). Another important drug, used to control blood pressure and pulse rate in cardiac patients, is [propranolol](#), an **antagonist** of another class of adrenergic receptors, which control blood pressure and heartbeat rate.

Studies of a great many agonists and antagonists of the catecholamines have revealed the existence in vertebrates of four types of catecholamine receptors, each of which has a distinctive pattern of response to these analogs. These are called the α 1-, α 2-, β 1-, and β 2-adrenergic receptors ([Table 23.3](#)). The structure of the β 2-adrenergic receptor is shown in [Figure 23.11](#).

See also: [Hormone Action](#), [Action of Epinephrine](#), [Hormone Receptors](#), [G Proteins and Signal Transduction](#)

INTERNET LINK: [Signal Transduction](#)

Isoproterenol

The agonist **isoproterenol** is used to treat asthma, because it mimics the effects of **catecholamines** in relaxing bronchial muscles in the lung; it does so by interacting with one specific class of adrenergic receptors (so-called because they bind adrenaline, the old name for **epinephrine**).

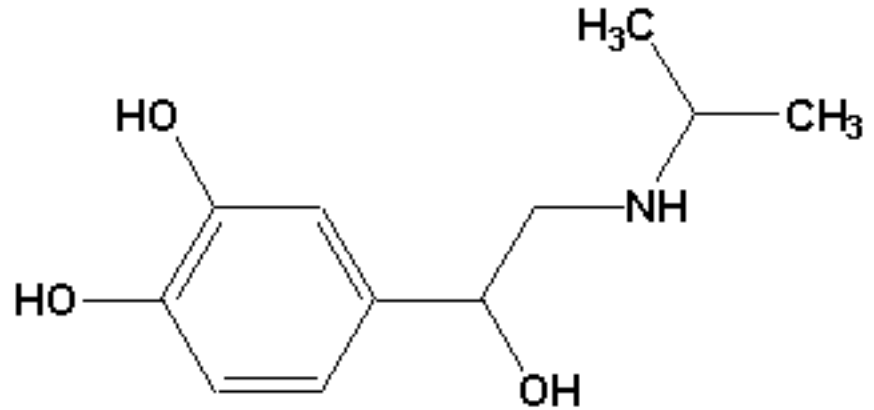

Isoproterenol

See also: [Signal Transduction Agonists and Antagonists](#)

INTERNET LINK: [Catecholamine Disorders](#)

Propranolol

Propranolol is an important drug used to control blood pressure and pulse rate in cardiac patients. **Propranolol** is an antagonist of adrenergic receptors which control blood pressure and heartbeat rate.

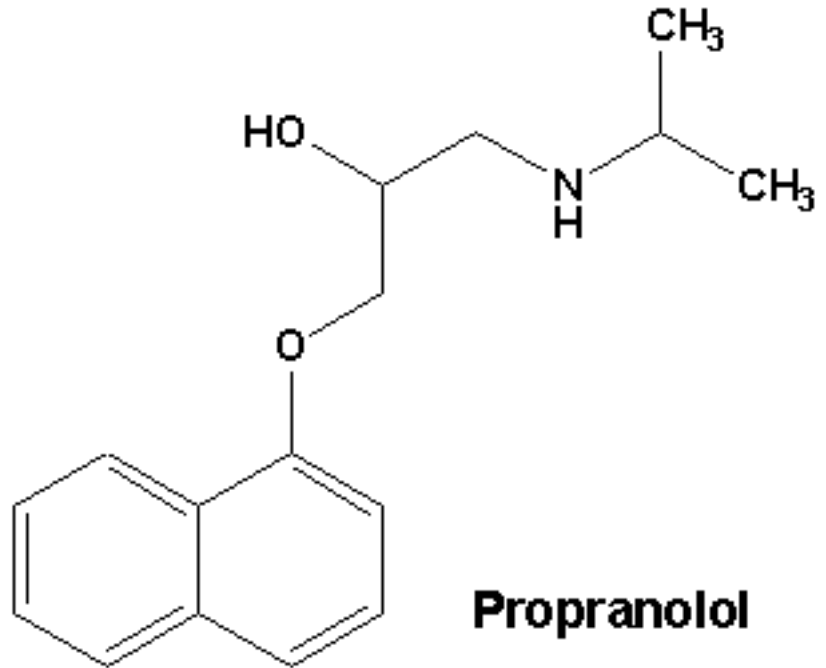

See also: [Signal Transduction Agonists and Antagonists](#)

Table 23.3

Receptor Class	Target Tissue	Effect of Hormone or Agonist
α_1	Iris of the eye	Contraction
	Intestine	Decreased motility
	Salivary glands	Potassium and water secretion
α_2	Pancreatic B cells	Decreased secretion
	Blood platelets	Aggregation
	Adipocytes	Decreased lipolysis
	Stomach	Decreased motility
α (subtype not identified)	Arterioles in skin, mucosa	Constriction
	Bladder sphincter	Contraction
	Male sex organs	Ejaculation
β_1	Heart	Increased rate, force, and depth of contraction
	Adipocytes	Increased lipolysis
	Intestine	Decreased motility
β_2	Lung	Muscle relaxation
	Liver	Increased glycogenolysis
	Intestine	Decreased motility

Source: Adapted from L. S. Goodman and A. C. Gilman, eds., *Pharmacological Basis of Therapeutics*, 7th ed. (New York: Macmillan, 1985), p. 72. © 1985 McGraw-Hill, Inc.

Figure 23.11: Amino acid sequence of the human β_2 -adrenergic receptor.

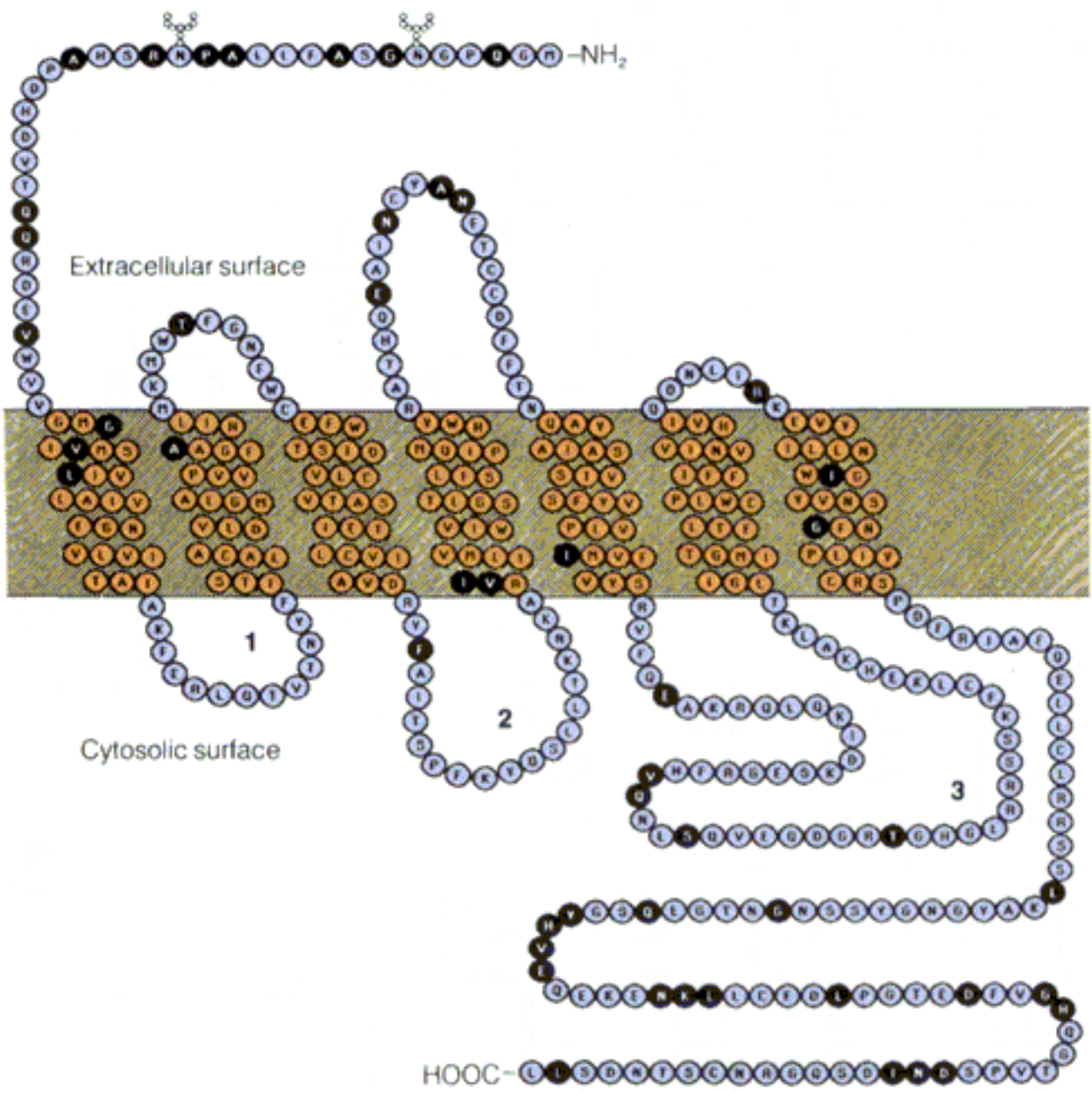

Marx, J. R., Science (1987) 238:615-616. © 1987 by AAAS.

N

In prokaryotic DNA the major methylated bases are [N⁶-methyladenine](#) (mA) and to a lesser extent **N⁴-methylcytosine**. Methylation in bacteria occurs at specific sites. In *E. coli*, methylation of A residues in the sequence 5'-GATC-3' is involved in mismatch error correction, and it plays a role in controlling initiation of DNA replication. Methylation at other sites protects DNA against cleavage by restriction endonucleases (described [here](#)).

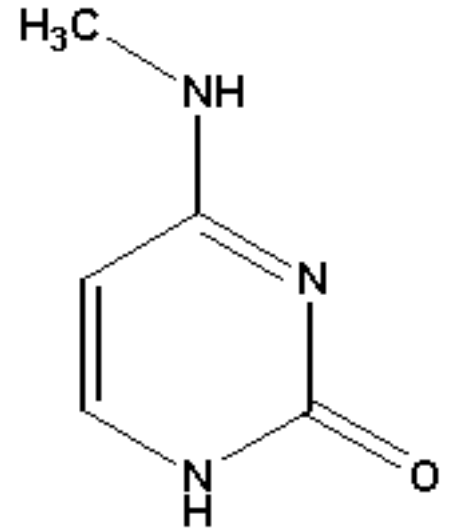

N4-methylcytosine

See also: [DNA Methylation](#), [Prokaryotic Mismatch Repair](#), [Initiation of DNA Replication](#)

INTERNET LINK: [The Effect of Site-Specific Methylation on Promega Restriction Enzymes](#)

Azacytidine

Azacytidine is an analog of **cytidine** in which the carbon at position 5 of the pyrimidine ring has been replaced by a nitrogen. **Azacytidine** is phosphorylated by cells and incorporated into DNA just like cytidine, but **azacytidine** cannot be methylated at position 5, the sole site of eukaryotic DNA methylation.

Eukaryotic cells treated with **azacytidine** exhibit changes in gene expression, probably due to the change in methylation patterns arising from incorporation of **azacytidine** into their DNA.

Interestingly, after the cells treated with azacytidine are allowed to replicate so as to replace the **azacytidine** residues with cytidine residues, the newly replicated sequences remain unmethylated, even if they were methylated prior to **azacytidine** treatment.

For example, **azacytidine** treatment can cause adult bone marrow cells to reactivate the synthesis of fetal hemoglobin, which is normally turned off during development.

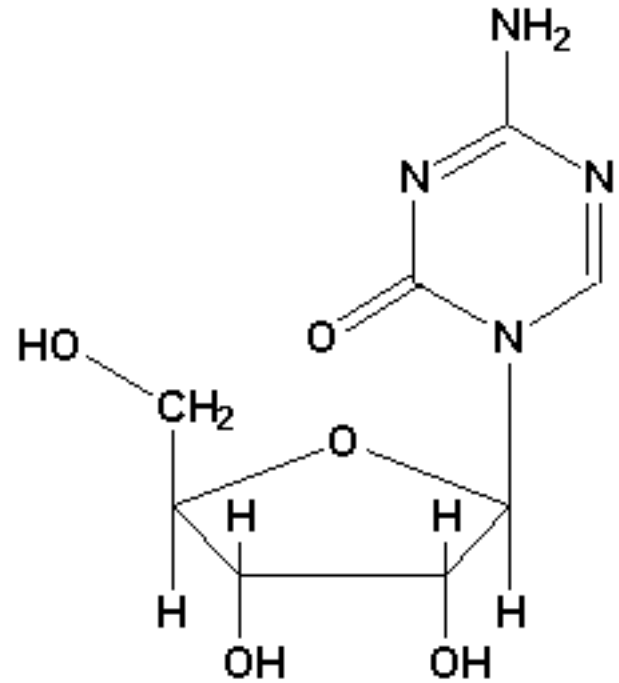

5-azacytidine

See also: [DNA Methylation](#), [Figure 25.3](#), [Globin Gene Expression in Development](#)

Gene Amplification

Selective **amplification** of specific regions of the genome, principally in eukaryotic cells, occurs in normal developmental processes and as a consequence of particular metabolic stress situations.

During oogenesis in certain amphibians the genes encoding ribosomal RNAs increase in copy number by some 2000-fold, in preparation for the large amount of protein synthesis that must occur in early development. The **amplified** DNA is in the form of extrachromosomal circles, each of which contains several copies of the ribosomal DNA repeat and a replication origin. A similar situation has been analyzed in *Drosophila*, in which genes encoding egg proteins are **amplified** at a particular developmental stage.

Both types of mechanisms apparently occur during development of certain drug-resistant mammalian cell lines in culture. This process has been studied most widely in cells that become resistant to methotrexate, a dihydrofolate reductase inhibitor. Treatment of leukemia with methotrexate often leads to the emergence of drug-resistant leukemic cell populations, which contain vastly elevated levels of the target enzyme, dihydrofolate reductase (**DHFR**). Overproduction of DHFR usually results from specific **amplification** of a large DNA segment that includes the DHFR gene. In one process, tandem duplication of the DNA segment generates a giant chromosome with multiple gene copies, in what is called a homogeneously staining region (HSR), because it lacks the typical chromosome banding pattern.

Alternatively, a DNA segment containing the Dhfr gene can be excised, apparently by a recombinational process, to form minichromosomes called double-minute chromosomes. Some resistant cells contain both types of **amplified** genes. Double-minute chromosomes are maintained within a cell only as long as selective pressure is maintained by growth of the cell in methotrexate. However, the chromosomally **amplified** phenotype is stable through many generations of cell growth. DHFR sequences were visualized by in situ hybridization with a fluorescent-tagged DNA containing DHFR sequences. This technique is sufficiently sensitive to allow detection of single-copy sequences (white arrows). Note also the giant chromosome containing many gene-equivalents of Dhfr gene sequences.

Amplification of genes under selective conditions has been widely observed—for example, in development of pesticide-resistant forms of insects. Such **amplified** structures could arise either through recombination with unequal sister-chromatid exchange, schematized in **Figure 25.41**, or by a conservative transposition process. Later, homologous recombination within an **amplified** region can lead to excision of sequences containing one or more **amplified** sequences. In order to replicate autonomously, these excised sequences must have a centromere. Such elements probably represent the double-minute chromosomes.

Selective pressure, such as the continuous presence of methotrexate, promotes specifically the survival of cells that can respond to that pressure (i.e., by overproducing DHFR). Once two or more copies of the gene are present on a chromosome, additional copies can be generated by further recombinational events

or by abnormalities of replication. Resistance is thus developed in stepwise fashion and occurs over many generations of growth.

See also: [Methotrexate](#)

Figure 25.41: Unequal crossing over, as a mechanism to explain early steps in gene amplification.

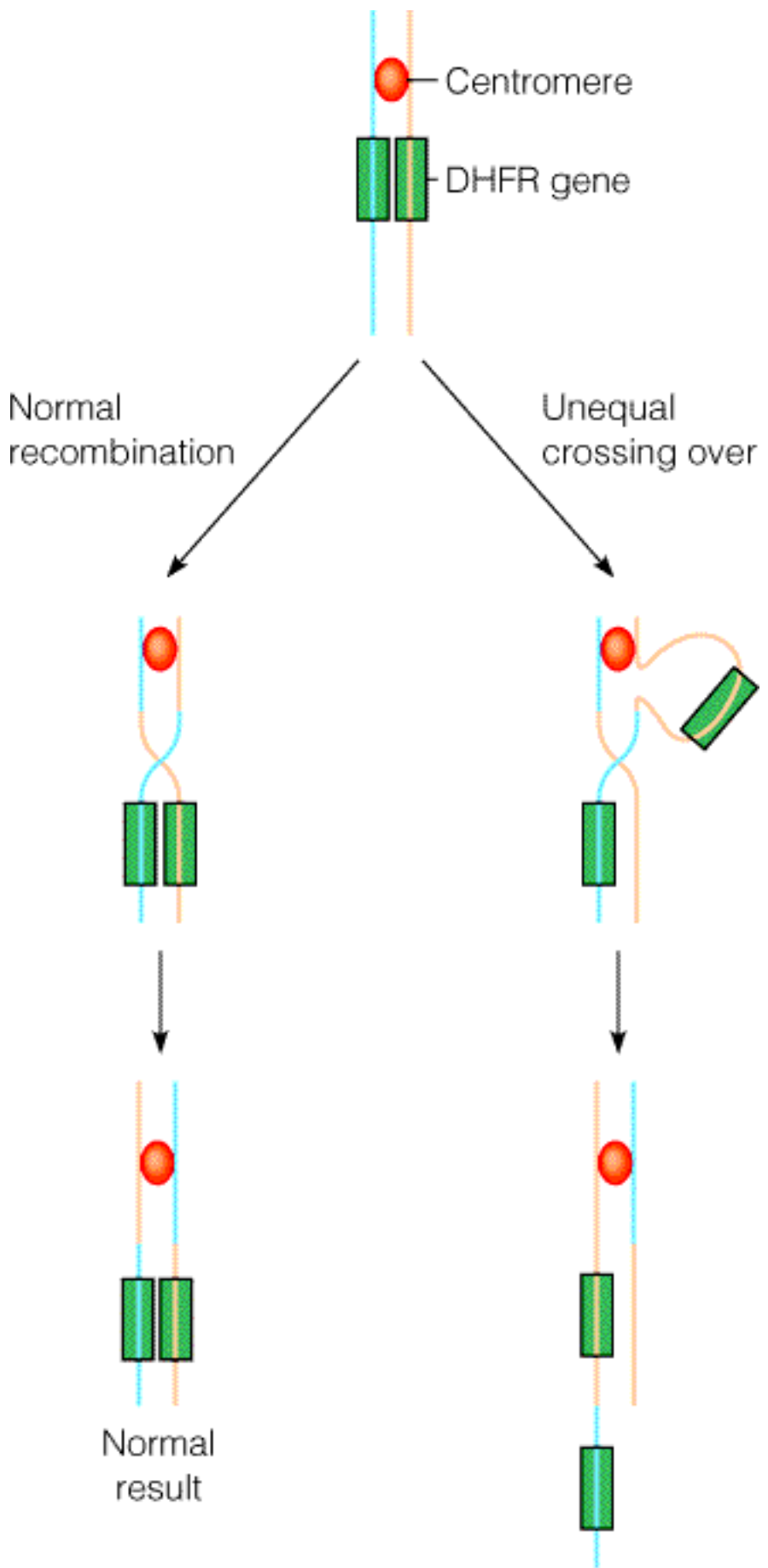

Normal
result

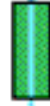

Gene
duplication

Retrovirus Transposition

Retroviruses of vertebrates are, perhaps, the most widely studied class of eukaryotic transposable elements. These RNA viruses use **reverse transcriptase** to synthesize a circular duplex DNA, which can integrate into many sites of the host cell chromosome. The integrated retroviral genome bears remarkable resemblance to a bacterial composite transposon (compare **Figure 25.38** with **Figure 25.35**).

The prototypical **retroviral** genome has three structural genes:

1. *gag*, which encodes a polyprotein that undergoes cleavage to give virion core proteins;
2. *pol*, which encodes the viral polymerase, or reverse transcriptase
3. *env*, which encodes the major glycoprotein of the viral envelope.

Flanking these structural genes are two direct repeats, the long terminal repeats (LTRs) of about 250 to 1400 base pairs each. Each LTR is flanked in turn by short inverted repeat sequences, 5 to 13 base pairs in length. Integration occurs by a mechanism that duplicates the target site, so that the integrated viral sequence, called a provirus, is flanked by direct repeats of host cell DNA (5 to 13 base pairs each).

Just as bacterial transposons can carry other genes, so also can **retroviruses**. In Rous sarcoma virus, the *src* oncogene (a gene that can cause cancer) lies to the 3' side of the *env* gene. Other tumorigenic viruses contain the oncogene either inserted into or substituting for one of the genes *gag*, *pol*, and *env*. Because the loss of an essential gene makes it impossible for the virus to replicate, the latter class of viruses can grow only in a cell coinfecting with a helper virus, a related retrovirus that provides the missing function (s).

An additional mechanism for the **retroviral** stimulation of cell transformation may be due to activation of cellular genes by insertion of proviral DNA. The leftmost LTR in an integrated provirus contains the transcriptional activator, or promoter, for the adjacent *gag* gene and the downstream *pol* and *env* genes. Because the LTRs are direct repeats, the rightmost LTR can activate transcription of cellular genes downstream (3' to) from the integration site. If these cellular genes include those involved in metabolic regulation, their overexpression may unbalance metabolism in some still undefined way and, hence, contribute to oncogenesis.

Transposable elements in eukaryotic cells show striking resemblances to retroviruses in sequence organization. The term retrotransposon is used to denote this class of elements. These similarities are illustrated in **Figure 25.39** for two retroviruses; Ty, a transposon of yeast; copia and 412, transposable elements in *Drosophila*; and IAP, a transposon found in the mouse genome.

See also: [Transposable Genetic Elements](#), [Site-Specific Recombination](#)

INTERNET LINKS:

1. [HIV Insite](#)
 2. [General Replication Strategies for RNA Viruses](#)
-

Figure 25.38: Structure of retroviral genomes in the integrated state.



(a) Nononcogenic virus

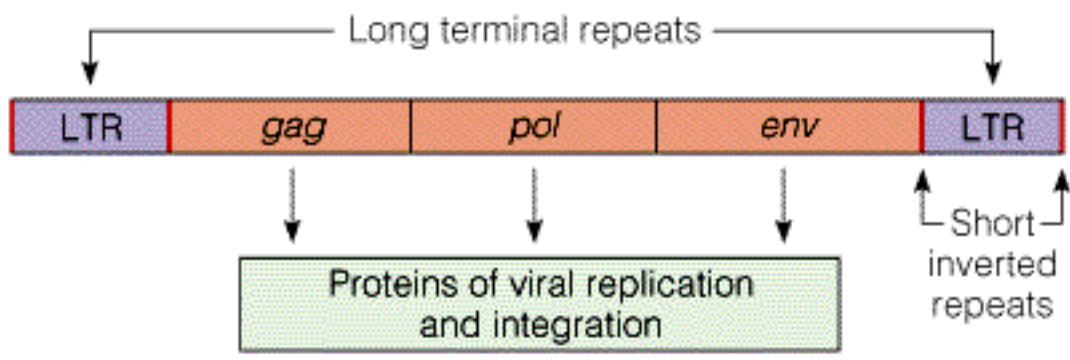

(b) Oncogenic virus



(c) Defective oncogenic virus

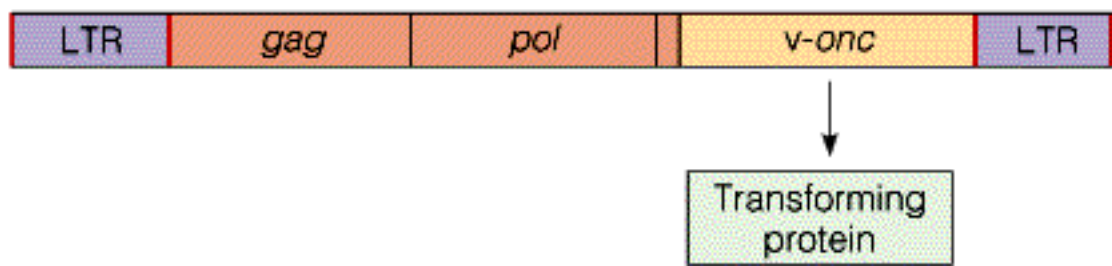
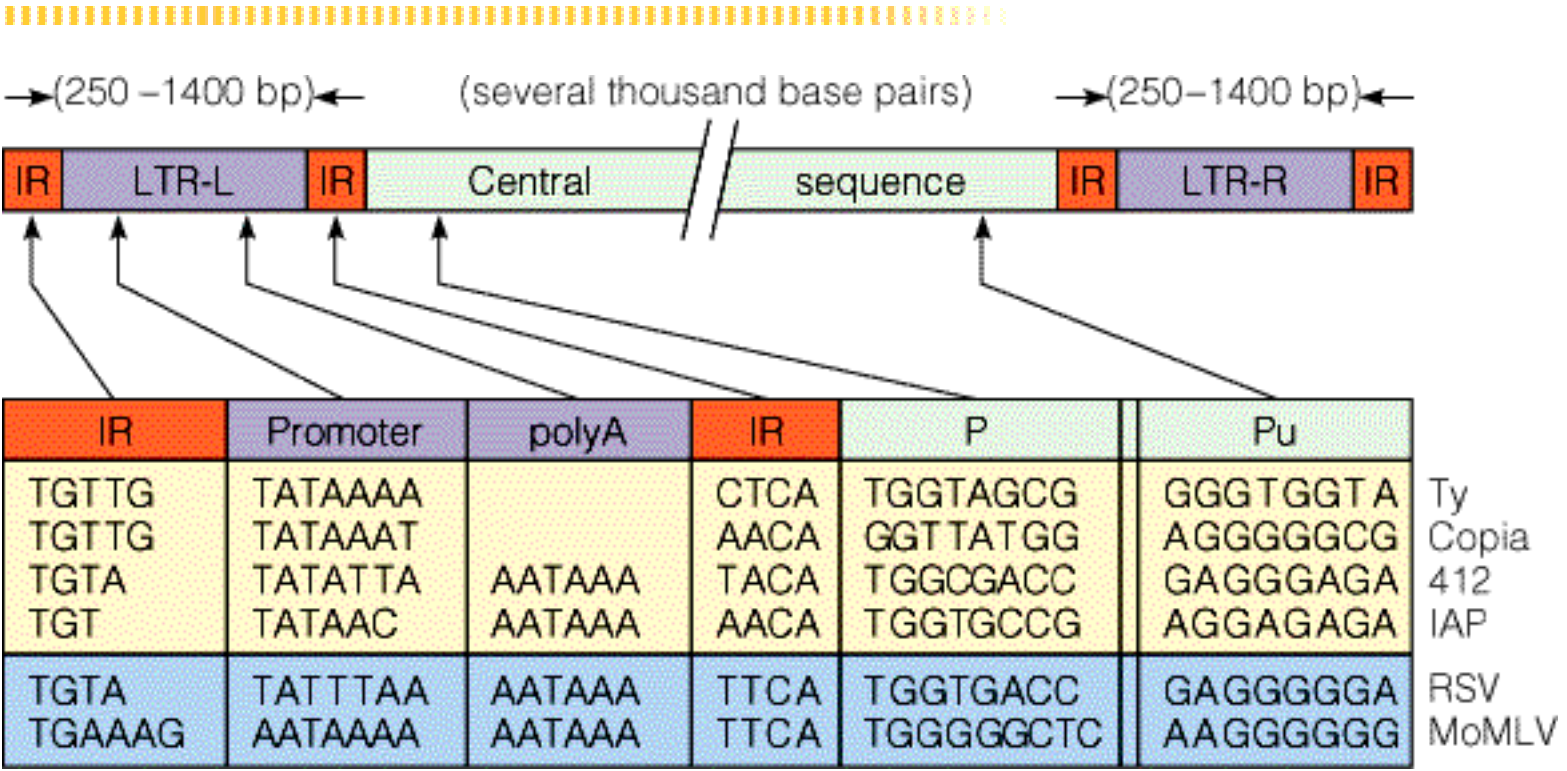

Figure 25.39: Common sequence features in integrated retroviruses and other eukaryotic transposable elements.



From M. Singer and P. Berg, *Genes and Genomes* (Sausalito, CA: University Science Books, 1991), p. 755.

Interleukin-2

Interleukin-2 is a protein sent as a signal by a helper T cell to a specific B cell. The B cell target is one that has recognized an antigen. **Interleukin-2** stimulates the target B cell to divide and produce more antibodies against the antigen.

See also: [The Immune Response](#), [T Cells and the Cellular Response](#), [Clonal Selection Theory](#)

INTERNET LINK: [Interleukins](#)

Digitoxin

Digitoxin is a glycoside poison that binds to and inhibits the action of the Na^+/K^+ pump in the cell membrane (see [here](#)). The Na^+/K^+ pump is essential for maintaining the balance of these ions across cell walls.

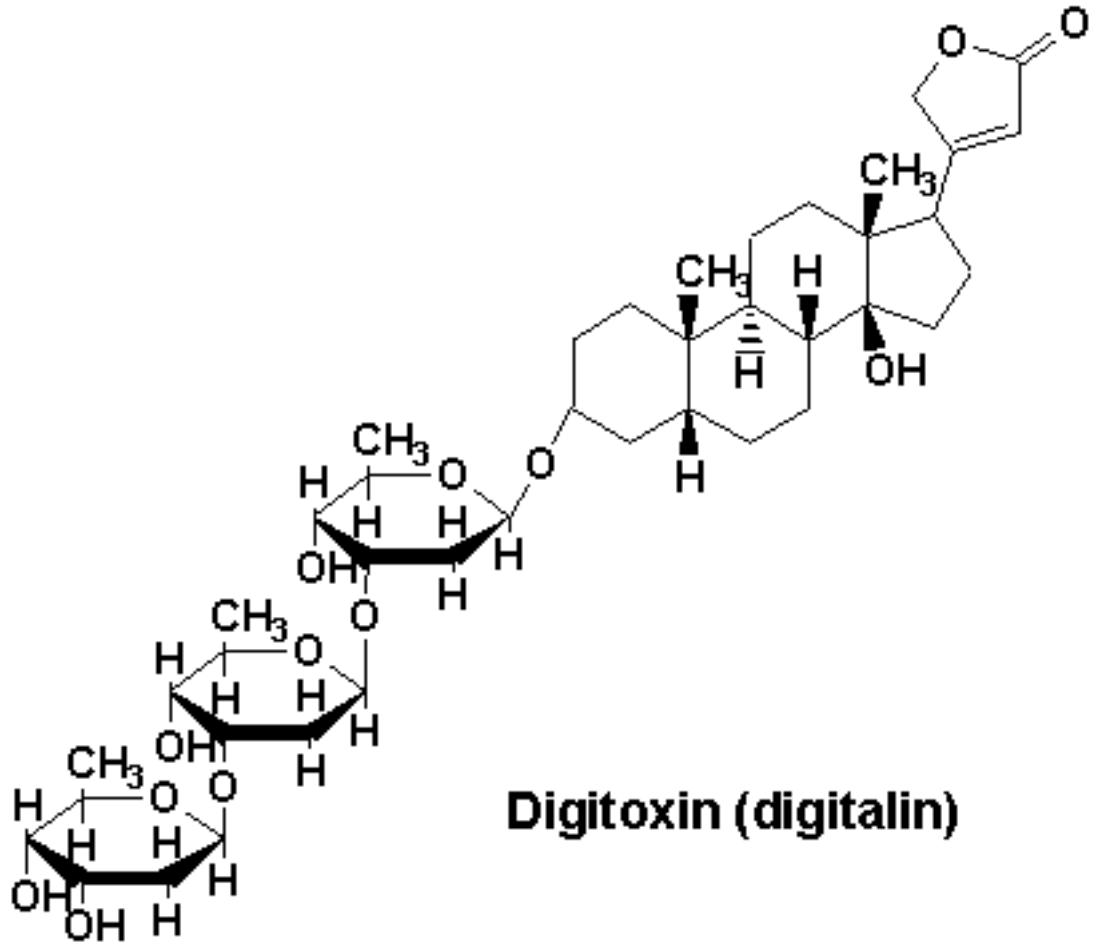

Digitoxin and ouabain are used to stimulate the heart muscle. They work by binding to the Na^+/K^+ ATPase and inhibiting its action. The result of this is that Na^+ leaks back into the cell. When this happens, the cell tries to maintain the osmotic balance pumping the sodium out with the $\text{Na}^+/\text{Ca}^{2+}$ pump. This pumps Ca^{2+} into the cell, which triggers muscle contraction.

INTERNET LINK: [Sodium-Potassium Pump Animation](#) (requires Shockwave)

Disaccharides



Disaccharides are composed of two sugar residues. Examples include [sucrose](#), [lactose](#), [maltose](#), [trehalose](#), and [gentiobiose](#)

See also: [Polysaccharides](#), [Glucose](#)

Trehalose



Trehalose is a disaccharide made by joining two glucose units together via $\alpha(1\rightarrow1)$ bonds.

See also: Figure 9.16a

Figure 9.16a: Structures of some important disaccharides.

(a) DISACCHARIDES with α connections

Maltose:
 α -D-glucopyranosyl
(1 \rightarrow 4) α -D-glucopyranose

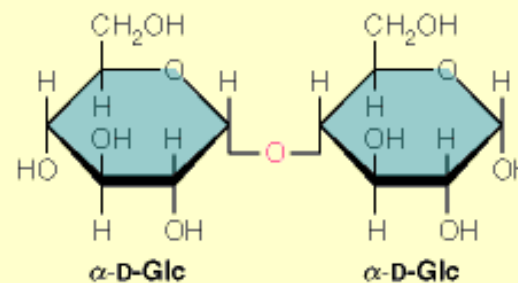
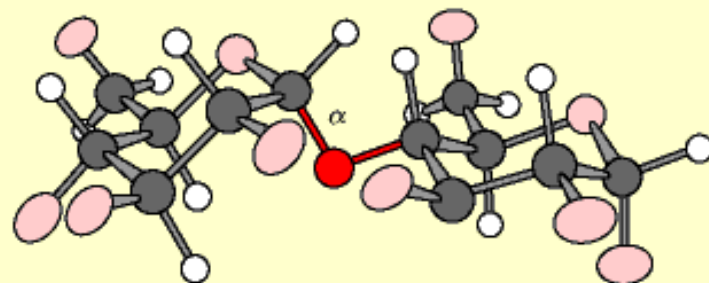

α,α -Trehalose:
 α -D-glucopyranosyl
(1 \rightarrow 1) α -D-glucopyranose

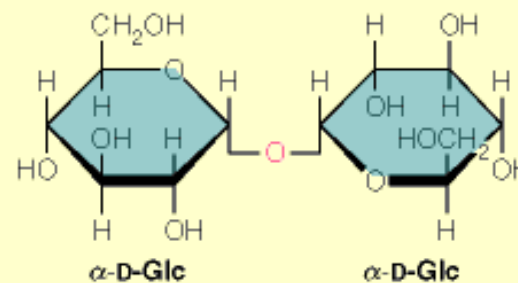
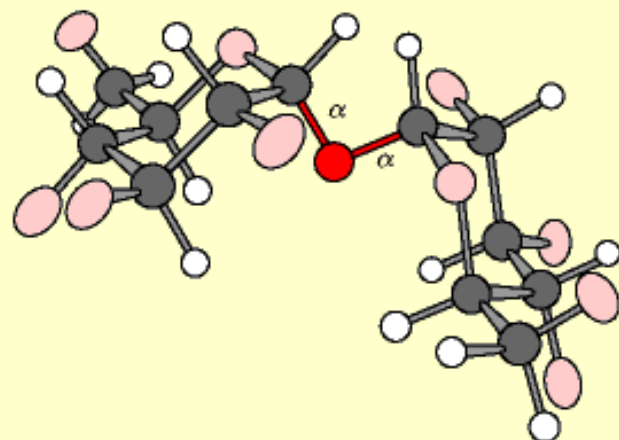

Sucrose:
 α -D-glucopyranosyl
(1 \rightarrow 2) β -D-fructofuranoside

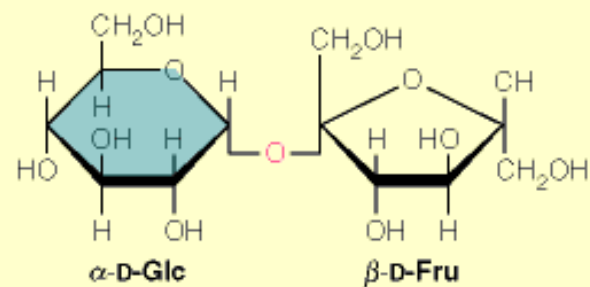
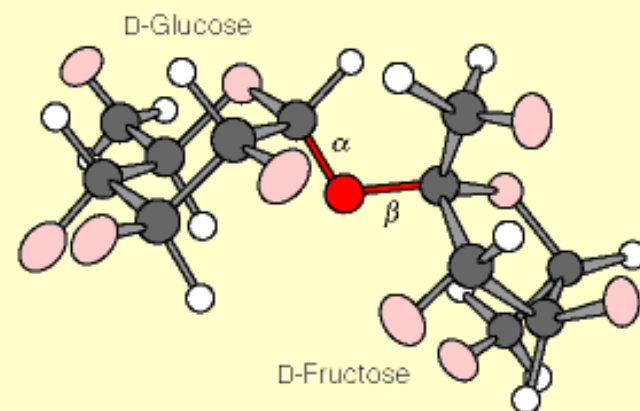

Gentiobiose

Gentiobiose is a **disaccharides** of **glucopyranose** units joined in the $\beta(1\rightarrow6)$ configuration.

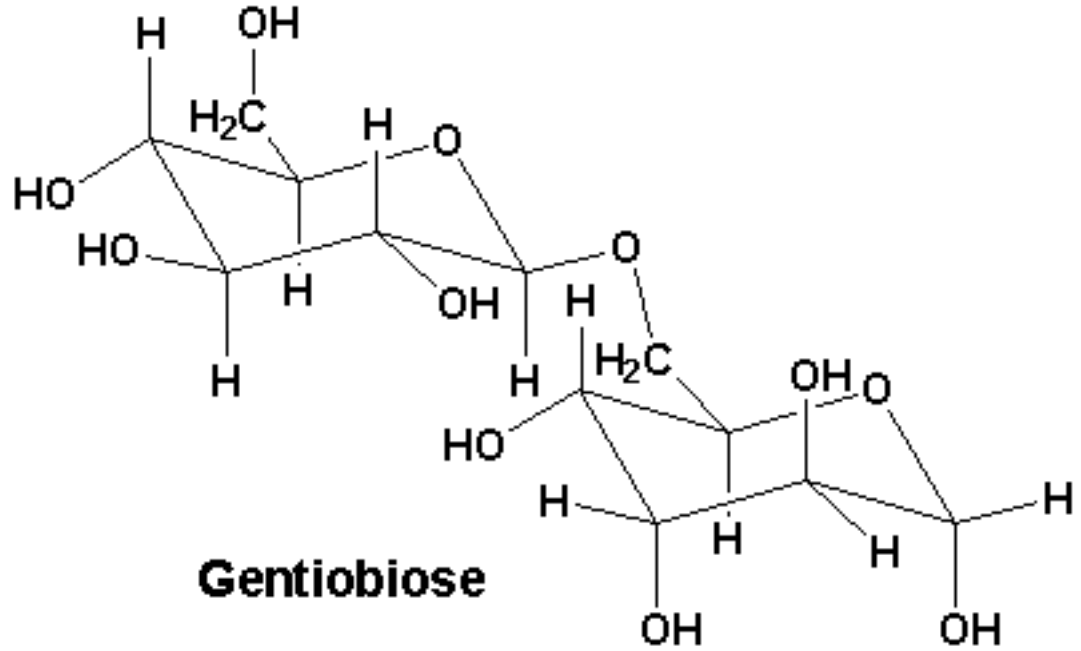

See also: [Figure 9.16b](#)

Figure 9.16b: Structures of some important disaccharides.

(b) DISACCHARIDES with β connections

Cellulose:
 β -D-glucopyranosyl
(1 \rightarrow 4) β -D-glucopyranose

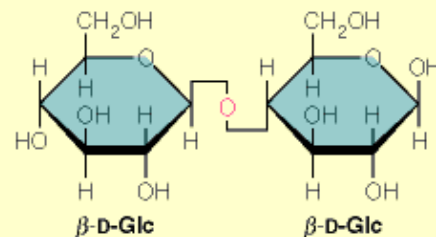
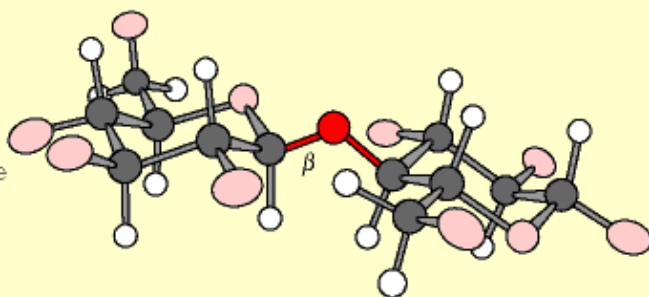

Lactose:
 β -D-galactopyranosyl
(1 \rightarrow 4) β -D-glucopyranose

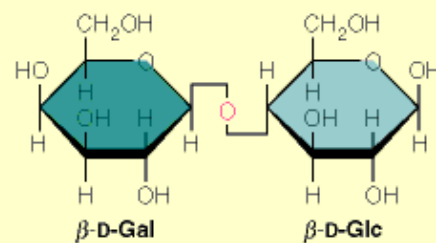
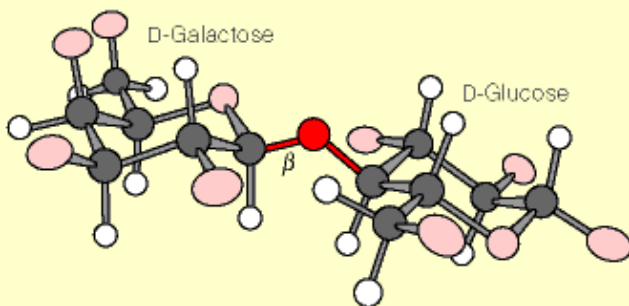

Gentiobiose:
 β -D-glucopyranosyl
(1 \rightarrow 6) β -D-glucopyranose

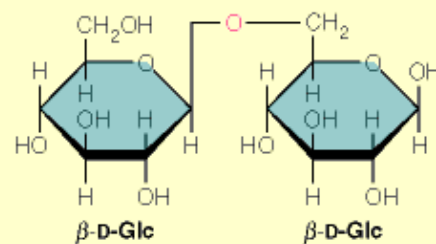
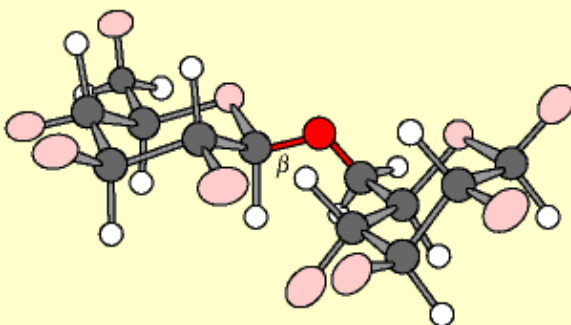

Cellobiose

Cellobiose is a disaccharides of glucose units joined in the β -1,4 linkage. The linkage between glucoses in **cellobiose** is the same as that in the cellulose polymer.

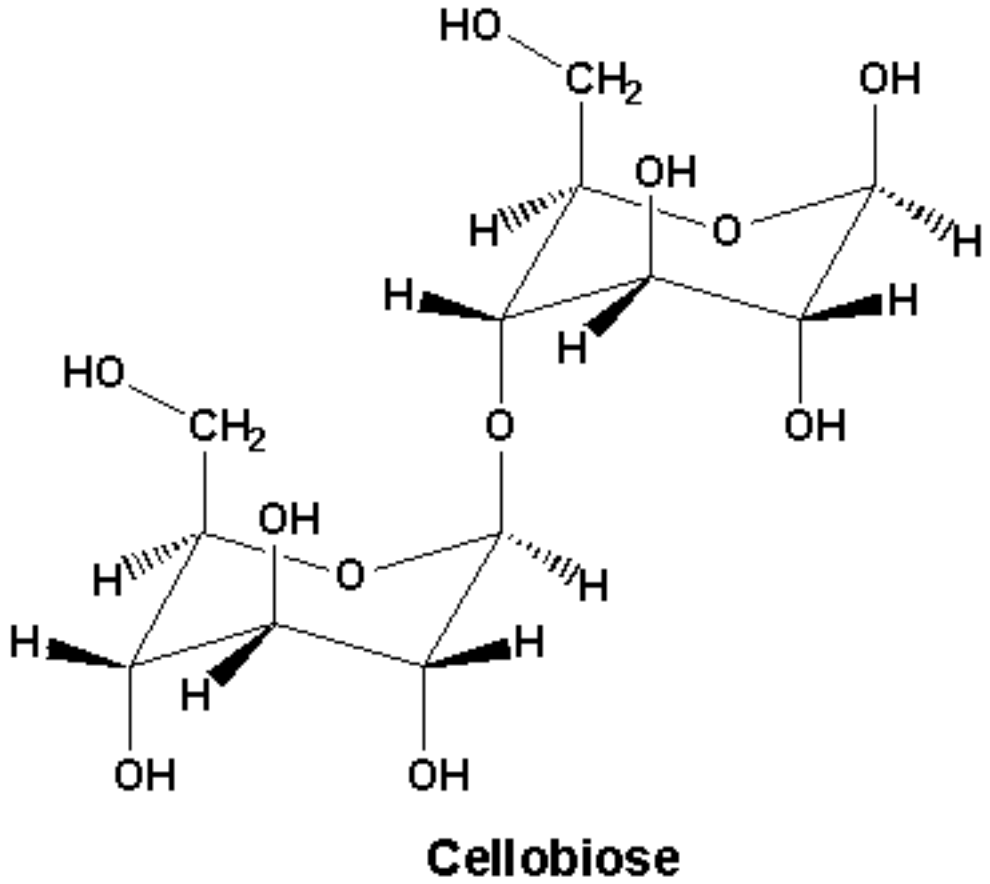

See also: [Figure 9.16b](#), [Table 9.5](#)

Table 9.5



Disaccharide	Structure	Natural Occurrence	Physiological Role
Sucrose	$\text{Glc}\alpha(1\rightarrow2)\text{Fru}\beta$	Many fruits, seeds, roots, honey	A final product of photosynthesis; used as primary energy source in many organisms
Lactose	$\text{Gal}\beta(1\rightarrow4)\text{Glc}$	Milk, some plant sources	A major animal energy source
α,α -Trehalose	$\text{Glc}\alpha(1\rightarrow1)\text{Glc}\alpha$	Yeast, other fungi, insect blood	A major circulatory sugar in insects; used for energy
Maltose	$\text{Glc}\alpha(1\rightarrow4)\text{Glc}$	Plants (starch) and animals (glycogen)	The dimer derived from the starch and glycogen polymers
Cellobiose	$\text{Glc}\beta(1\rightarrow4)\text{Glc}$	Plants (cellulose)	The dimer of the cellulose polymer
Gentiobiose	$\text{Glc}\beta(1\rightarrow6)\text{Glc}$	Some plants (e.g., gentians)	Constituent of plant glycosides and some polysaccharides

Table 23.5



Extracellular Signal	Target Tissue	Cellular Response
Acetylcholine	Pancreas	Amylase secretion
	Pancreas (islet cells)	Insulin release
	Smooth muscle	Contraction
Vasopressin	Liver	Glycogenolysis
Thrombin	Blood platelets	Platelet aggregation
Antigens	Lymphoblasts	DNA synthesis
	Mast cells	Histamine secretion
Growth factors	Fibroblasts	DNA synthesis
Spermatozoa	Eggs (sea urchin)	Fertilization
Light	Photoreceptors (<i>Limulus</i>)	Phototransduction
Thyrotropin-releasing hormone	Pituitary anterior lobe	Prolactin secretion

Source: Adapted from M. J. Berridge, *Sci. Am.* (1985) Oct., p. 147. © 1985 Andrew Christie.

RU486

The drug, **RU486**, binds to progesterone receptors and blocks the events essential to implantation of a fertilized ovum in the uterus. Hence, **RU486** is an effective contraceptive agent, even when taken after intercourse.

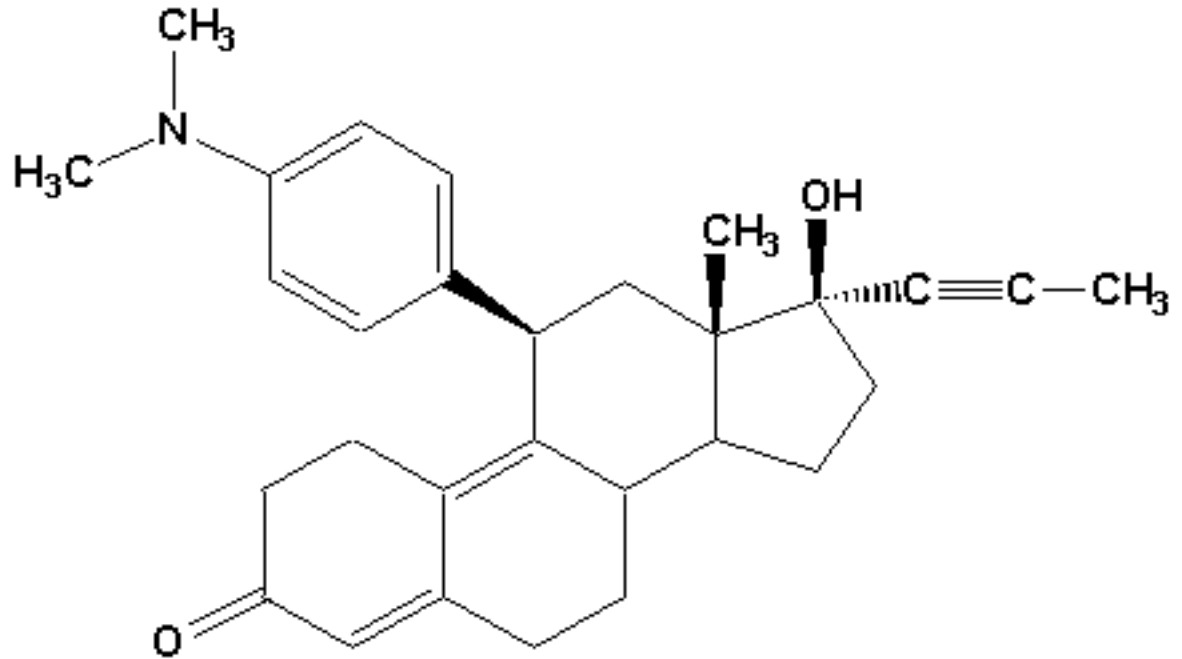

RU486

See also: [Hormone Receptors](#), [Steroid Hormones](#), [Steroid and Thyroid Hormones - Intracellular Receptors](#)

17-Hydroxyprogesterone

17-Hydroxyprogesterone is a branch point between synthesis of the glucocorticoids and the androgens. Thus, deficiency of 17-hydroxylase, the enzyme responsible for catalyzing the synthesis of **17-hydroxyprogesterone**, leads to reduced amounts of [cortisol](#) (glucocorticoid), [androgens](#), and [estrogens](#).

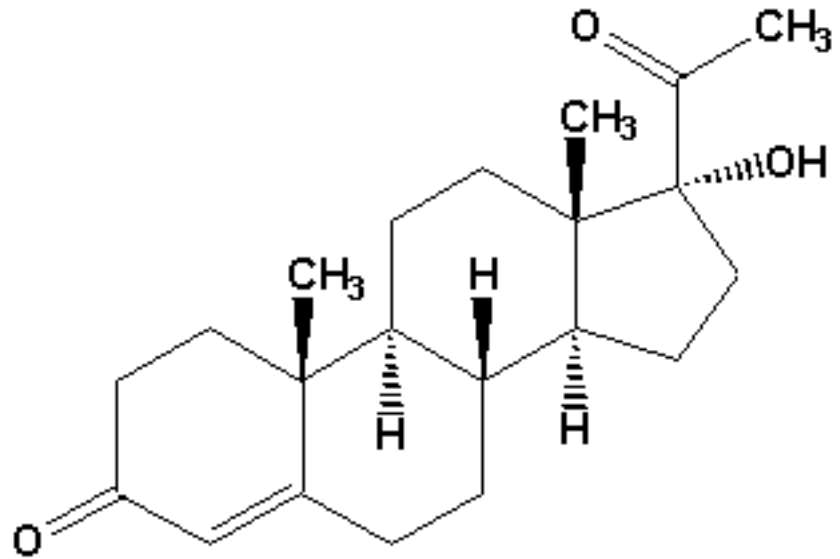

17-Alpha-hydroxyprogesterone

See also: [Steroid Hormone Synthesis](#), [Steroid Metabolism](#), [Steroid Hormones](#), [Cholesterol Biosynthesis](#), [Cholesterol](#)

INTERNET LINKS:

1. [Steroid Hormone Metabolism](#)
 2. [Androgen and Estrogen Metabolism](#)
-

Diethylstilbestrol

Diethylstilbestrol is a synthetic estrogen previously used to promote growth of beef cattle, until it was found to be potentially carcinogenic at the levels found in meat from treated cattle.

See also: [Steroid Hormone Synthesis](#)

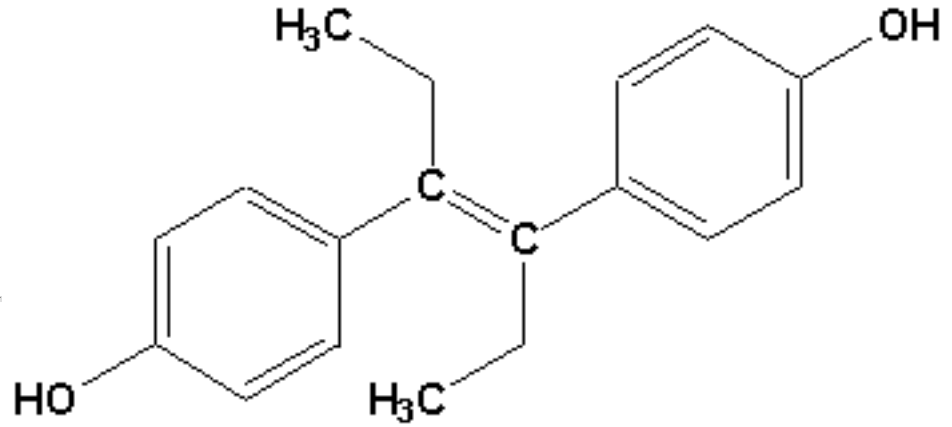

Diethylstilbestrol

Mestranol

Mestranol is an oral contraceptive.

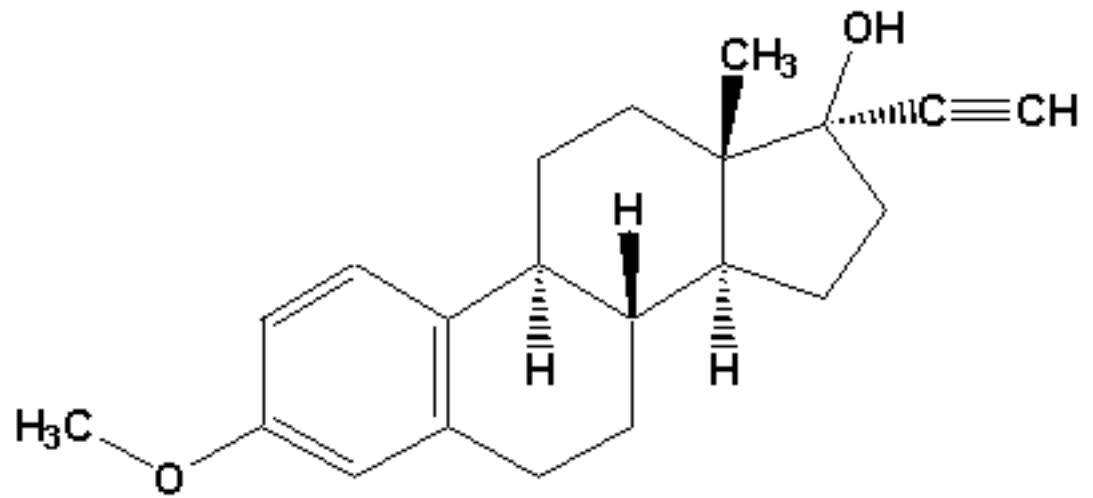

Mestranol

See also: [Steroid Metabolism](#), [Steroid Hormones](#), [Cholesterol Biosynthesis](#), [Cholesterol](#)

INTERNET LINKS:

1. [Steroid Hormone Metabolism](#)
 2. [Androgen and Estrogen Metabolism](#)
-

Mestranol

Mestranol is an oral contraceptive.

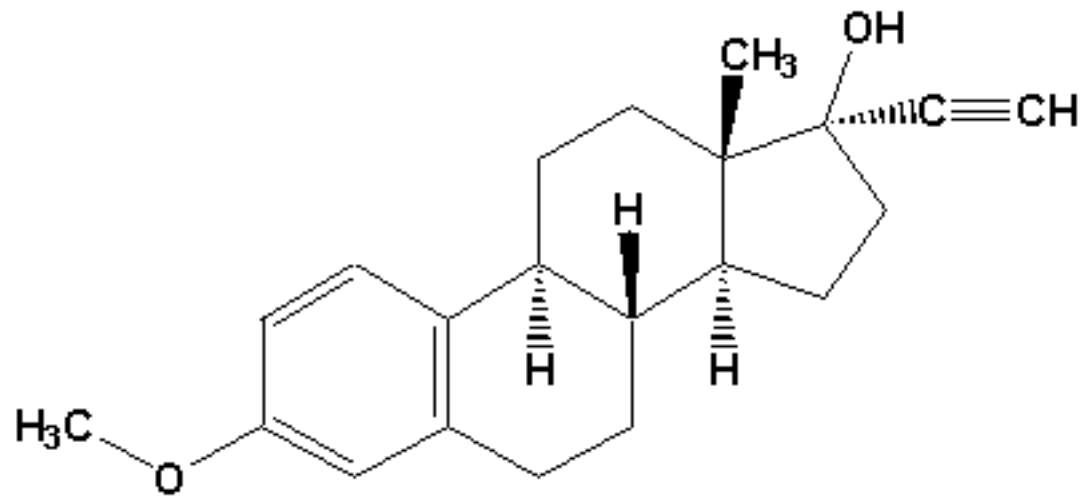

Mestranol

See also: [Steroid Metabolism](#), [Steroid Hormones](#), [Cholesterol Biosynthesis](#), [Cholesterol](#)

INTERNET LINKS:

1. [Steroid Hormone Metabolism](#)
 2. [Androgen and Estrogen Metabolism](#)
-

Deoxycholic Acid (Deoxycholate)

Deoxycholate, a bile acid, is abundant in the bile of some mammals. It is widely used as a laboratory reagent, to solubilize membrane proteins, due to its detergent properties.

Bile salts play important roles in emulsification of fat in the digestion process ([Figure 18.4](#)).

See also: [Cholesterol Biosynthesis](#), [Bile Salts and Emulsion of Fats](#), [Cholesterol](#)

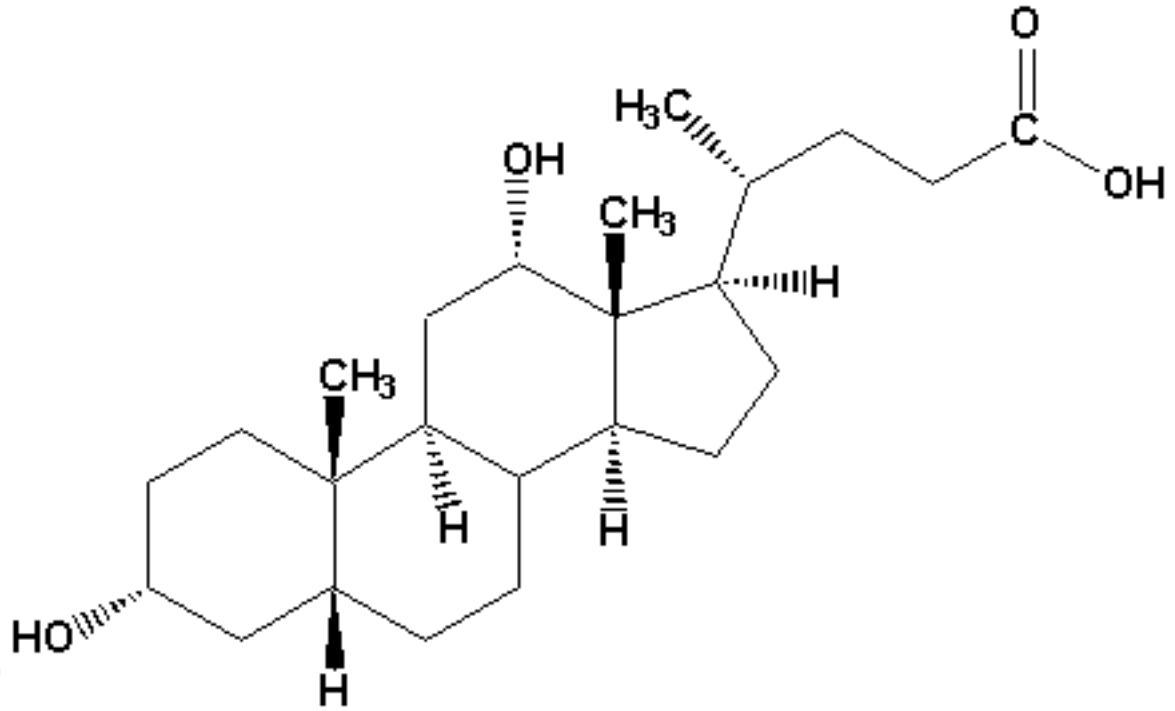

Deoxycholic Acid (deoxycholate)

INTERNET LINK: [Bile Acid Biosynthesis](#)

3-Ketoacyl-CoA Transferase



3-Ketoacyl-CoA transferase catalyzes the exchange of acetoacetate for succinate on coenzyme A:

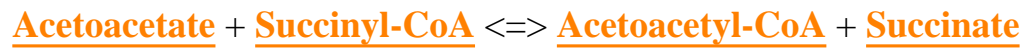

See also: [Ketogenesis](#)

Biological Fuel

In a differentiated organism, each tissue must be provided with **fuels** that it can use, in amounts sufficient to meet its own **energy** needs and to perform its specialized roles. **Energy** production must meet needs that vary widely, depending on level of exertion, composition of **fuel** molecules in the diet, time since last feeding, and so forth. In humans, for example, the daily caloric intake may vary by 4-fold, depending in part on the level of exertion—from 1500 to 6000 kcal/day in an average-sized human or, in the thermodynamic units used in the text, from 6000 to 25,000 kJ/day.

The major **fuel** depots are [triacylglycerols](#), stored primarily in adipose tissue; [protein](#), most of which exists in skeletal muscle; and [glycogen](#), which is stored in both liver and muscle ([Figure 23.1](#) and [Table 23.1](#)). In general, an organ specialized to produce a particular fuel lacks the enzymes to use that fuel. For example, [ketone bodies](#) are synthesized in the liver, so little catabolism of ketone bodies occurs there.

See also: [Brain Metabolism](#), [Muscle Metabolism](#), [Heart Metabolism](#), [Adipose Tissue Metabolism](#), [Blood Metabolism](#), [Hormonal Regulation of Fuel Metabolism](#)

Figure 23.1: Metabolic interactions among the major fuel-metabolizing organs.

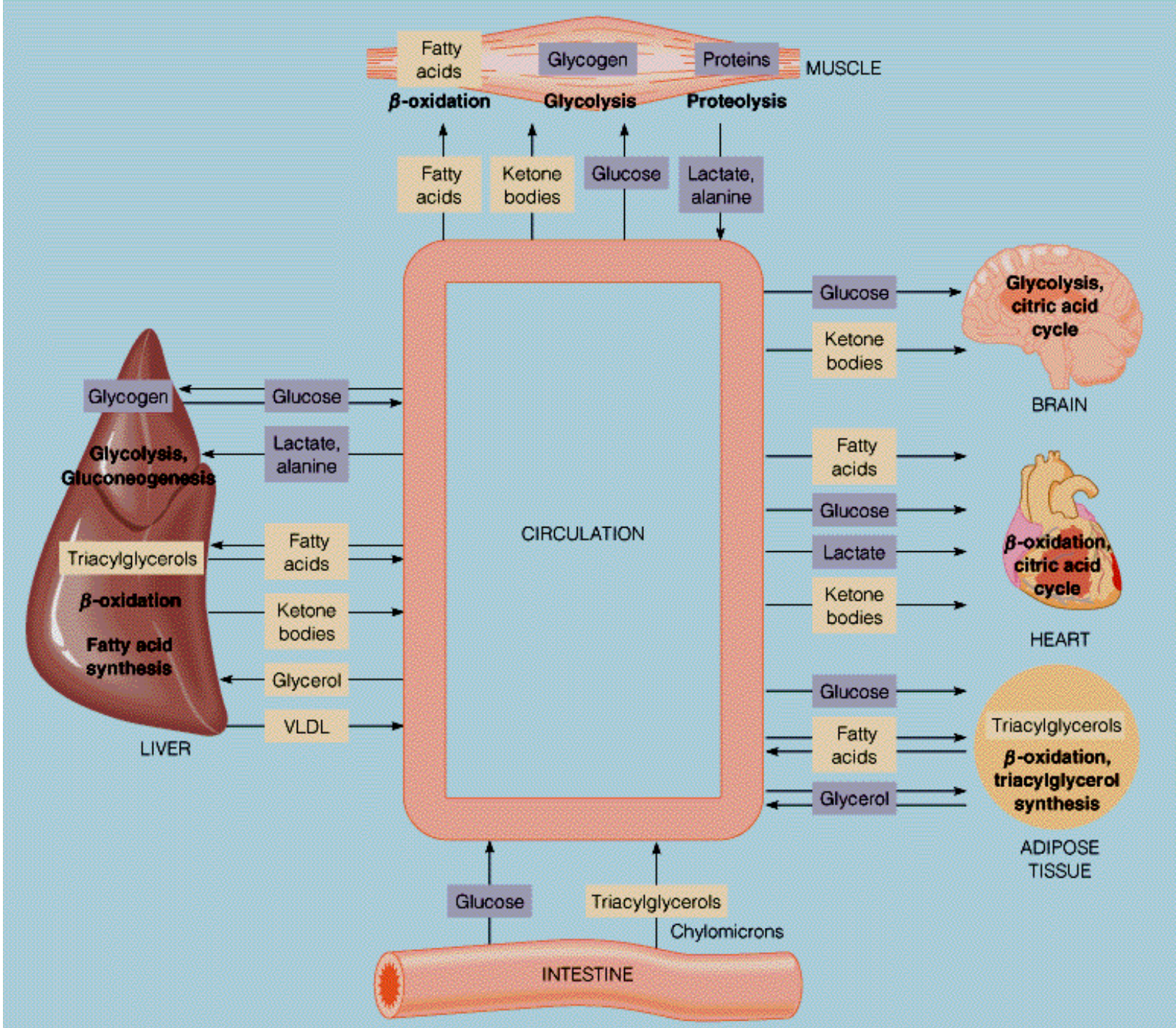

Brain Metabolism

The **brain** must generate ATP in large quantities to maintain the membrane potentials essential for transmission of nerve impulses. Under normal conditions the **brain** uses only glucose to meet its prodigious energy requirements, which amounts to about 60% of the glucose utilization of a human at rest. The **brain's** need for about 120 grams of glucose per day is equivalent to 1760 kJ-about 15% of the total energy consumed each day. The **brain's** quantitative requirement for glucose remains quite constant, even when an animal is at rest or asleep.

The **brain** is a highly aerobic organ, too, and its metabolism utilizes some 20% of the total oxygen consumed by a human. Because the **brain** has no significant glycogen or other fuel reserves, the supply of both oxygen and glucose cannot be interrupted, even for a short time. Otherwise, anoxic **brain** damage results. However, the **brain** can adapt during fasting to use ketone bodies instead of glucose as a major fuel.

See also: Biological Fuel, Liver Metabolism, Ketogenesis (from Chapter 18), Biochemistry of Neurotransmission, (from Chapter 21) Neurotransmitters and Receptors (from Chapter 21), Figure 23.4

Liver Metabolism

One of the most important roles of the liver is to serve as a "glucostat," monitoring and stabilizing blood **glucose** levels. To meet its internal energy needs, the liver can use a variety of fuel sources, including glucose, **fatty acids**, and **amino acids**. A primary role of liver is the synthesis of fuel components for use by other organs. Most of the low-molecular-weight metabolites that appear in the blood through digestion are taken up by the liver for this metabolic processing. Compounds synthesized in the liver include the following:

1. **Fatty acids** - The liver is a major site for **fatty acid** synthesis.
2. **Glucose** - The liver produces **glucose**, both from its own **glycogen** stores and from **gluconeogenesis**, the latter using **lactate** and **alanine** from muscle, **glycerol** from adipose tissue, and the amino acids not needed for protein synthesis. An important role of liver is to buffer the level of blood **glucose**. It does this largely through the action of **glucokinase**, an enzyme peculiar to liver, with a high K_M (about 10 mM) for **glucose**, and partly through a high- K_M transport protein, the **glucose** transporter. Thus, liver is unique in being able to respond to high blood **glucose** levels by increasing the uptake and phosphorylation of glucose, which results eventually in its deposition as glycogen. **Glucose-6-phosphate** accumulation activates the D form of **glycogen synthase**. In addition, **glucose** itself binds to **glycogen phosphorylase a**, increasing the susceptibility of phosphorylase a to dephosphorylation (see **Figure 13.18**), with consequent inactivation. Thus, in addition to hormonal effects (see **here**), the liver senses the fed state and acts to store fuel derived from **glucose**. The liver also senses the fasted state and increases the synthesis and export of **glucose** when blood **glucose** levels are low. (Other organs also sense the fed state, notably the pancreas, which adjusts its glucagon and insulin outputs accordingly.)
3. **Ketone bodies** - **Ketone bodies** are also manufactured largely in the liver. The level of **malonyl-CoA** in liver, which is related to the energy status of the cell, determines the fate of fatty acyl-CoAs. When fuel is abundant, malonyl-CoA accumulates and inhibits **carnitine acyltransferase I**, preventing the transport of fatty acyl-CoAs into mitochondria for **β -oxidation** and **ketogenesis**. On the other hand, shrinking malonyl-CoA pools signal the cells to transport fatty acids into the mitochondria, for generation of energy and fuels.

See also: **Biological Fuel**, **Hormonal Regulation of Fuel Metabolism**, **Figure 23.4**

Muscle Metabolism

Muscle can utilize a variety of fuels-[glucose](#), [fatty acids](#), and [ketone bodies](#). **Skeletal muscle** varies widely in its energy demands and the fuels it consumes, in line with its wide variations in activity.

In resting **muscle**, fatty acids represent the major energy source; during exertion, glucose is the primary source. Early in a period of exertion, glucose comes from mobilization of the muscle's [glycogen](#) reserves.

Skeletal **muscle** stores about three-fourths of the total glycogen in humans, with most of the rest being stored in the liver. Glucose released from **muscle** glycogen cannot be released from the cell for use by other tissues. **Muscle** lacks the enzyme [glucose-6-phosphatase](#), so glucose phosphates derived from glycogen cannot be converted to glucose and released from the cell.

During exertion, the rate of [glycolysis](#) in **muscle** exceeds that of the [citric acid cycle](#), so [lactate](#) accumulates and is released. Another metabolic product is [alanine](#), produced via [transamination](#) from [pyruvate](#) in the [glucose - alanine cycle](#) (see [Figure 20.14](#) and [here](#)). Both lactate and alanine are transported through the bloodstream to the liver, where they are reconverted through [gluconeogenesis](#) to glucose, for return to the **muscle** and other tissues by the [Cori cycle](#) (see [Figure 16.5](#) and [here](#)).

Muscle contains another readily mobilizable source of energy-its own protein. However, the breakdown of **muscle** protein to meet energy needs is both energetically wasteful and harmful to an animal, which must move about in order to survive. Protein breakdown is regulated so as to minimize amino acid catabolism except in starvation.

Muscle has an additional energy reserve in [creatine phosphate](#), which generates ATP without the need for metabolizing fuels (see [here](#)). This reserve is exhausted early in a period of exertion and must be replenished, along with glycogen stores, as **muscle** rests after prolonged exertion.

See also: [Biological Fuel](#), [Heart Metabolism](#), [Figure 23.4](#)

Gluconeogenesis Precursors

We often think of **gluconeogenesis** as starting with pyruvate, but other carbon sources than pyruvate can be used to make **glucose** via **gluconeogenesis**. Some of these molecules and their points of entry into gluconeogenesis are shown in [Figure 16.4](#).

Note that breakdown products of fat metabolism (glycerol, propionyl-CoA), protein degradation (alanine, other amino acids), and anaerobic glycolysis (lactate) are substrates for **gluconeogenesis**. Notably, the primary breakdown product of fat, **acetyl-CoA**, is not shown, because it cannot be effectively used by animals in **gluconeogenesis**. Some of the substrates are summarized as follows:

Lactate - the most significant **gluconeogenesis** precursor. **Lactate** is produced when insufficient oxygen is present to maintain aerobic glycolysis. **Lactate** in exercising muscle is released into the blood where it travels to the liver for participation in **gluconeogenesis**. The newly synthesized glucose reenters the blood and travels back to the muscle where it is needed. This cycle, called the [Cori cycle](#), is shown in [Figure 16.5](#).

Amino Acids - **Alanine** and 17 other amino acids from proteins yield **gluconeogenic** precursors in their catabolic pathways. Only **leucine** and **lysine** do not produce **gluconeogenic** precursors. Amino acids which produce **gluconeogenic** precursors are called glucogenic. During starvation or fasting, catabolism of muscle proteins occurs as a means of generating sufficient precursors for **gluconeogenesis** that are not available in the diet.

Glycerol - the backbone of the fats and **glycerophospholipids**. Aside from propionyl-CoA produced by oxidation of rare, odd-chain fatty acids, glycerol is the only portion of the fat molecule that can be made into glucose by animals.

Propionate - Oxidation of fatty acids containing an odd number of carbons ultimately yields a three carbon molecule, **propionyl-CoA**. Propionyl-CoA is converted to **succinyl-CoA** in an unusual set of reactions shown [here](#). Succinyl-CoA can ultimately be converted to the **gluconeogenic** intermediate, **oxaloacetate**.

See also: [Gluconeogenesis Substrates](#), [Regulation of Gluconeogenesis](#), [Gluconeogenesis](#), [Relationship of Gluconeogenesis to Glycolysis](#), [Regulation of Gluconeogenesis](#), [Glycolysis](#)

Figure 16.4: Outline of pathways for glucose synthesis from the major gluconeogenic precursors.

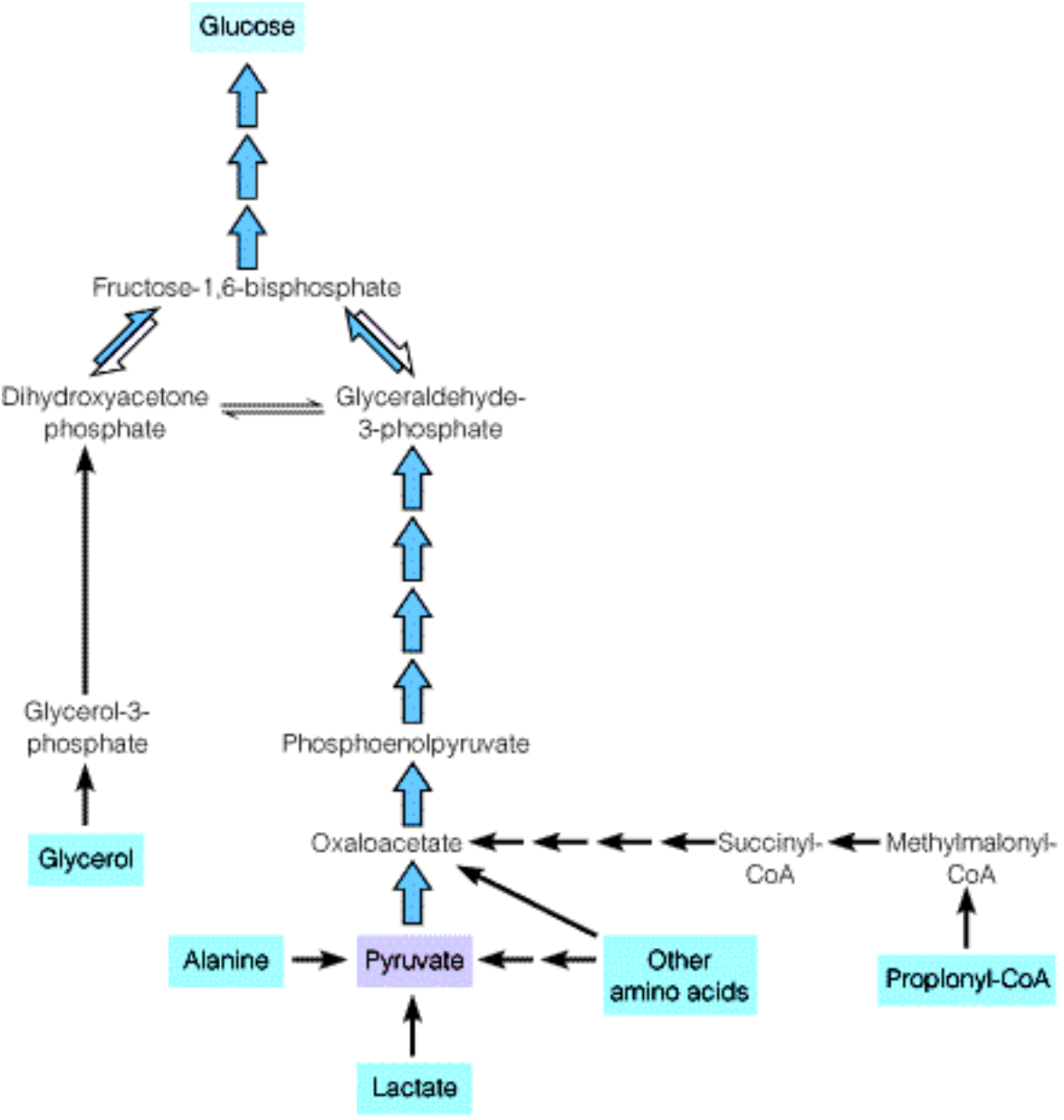

Unnumbered Item

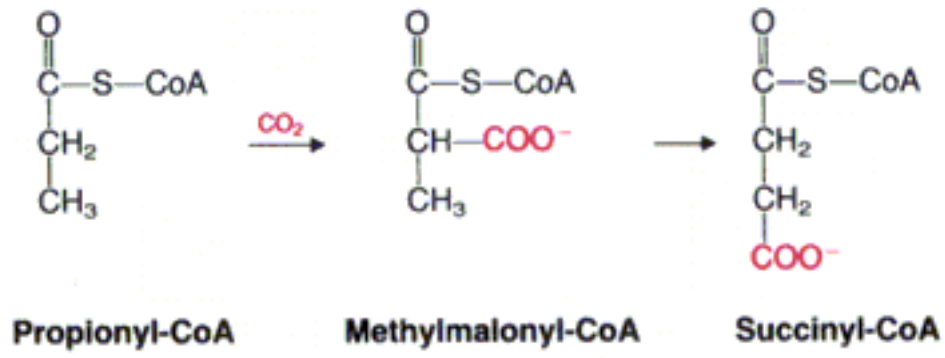

Relationship of Gluconeogenesis to Glycolysis

Though many of the steps of **gluconeogenesis** are the simple reversal of steps of **glycolysis**, there are three important steps in **glycolysis** that are replaced by four different steps in **gluconeogenesis**. Each of these steps is very energetically favored for **glycolysis**, so the **gluconeogenesis** pathway could not effectively reverse them. Instead, in two of the three steps, **gluconeogenesis** reactions omit regeneration of the ATP used in **glycolysis**, simply hydrolyzing the phosphate instead. This allows the reaction to proceed by "saving" the energy that would otherwise be put into regenerating ATP. The third **glycolysis** step that is bypassed is overcome by a set of two "sidestep" reactions in which ATP and GTP energy is expended to generate phosphoenolpyruvate, a high-energy intermediate, .

Figure 16.3 schematically illustrates the differences between **glycolysis** and **gluconeogenesis**. Six of the seven reactions common to the two pathways are not shown. In each case, the name of the **gluconeogenesis** enzyme that differs from the corresponding **glycolysis** enzyme is given. The reactions unique to **gluconeogenesis** are the following:



This reaction is catalyzed by **pyruvate carboxylase**. Unlike the other reactions of **glycolysis** and **gluconeogenesis**, this reaction occurs in the mitochondrial matrix.



This reaction is catalyzed by **phosphoenolpyruvate carboxykinase - PEPCK**.

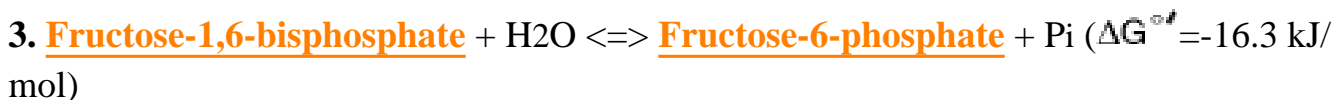

This reaction is catalyzed by **fructose 1,6 bisphosphatase**.



This reaction is catalyzed by **glucose-6-phosphatase**.

In all the other reactions, **gluconeogenesis** proceeds simply by reversing the corresponding reaction of **glycolysis**. The entire pathway is summarized in **Table 16.1**. Note that the overall $\Delta G^{\circ\prime}$ for **gluconeogenesis** is negative (-47.6 kJ/mol). **Glycolysis** too has an overall negative $\Delta G^{\circ\prime}$ (-73.3 kJ/mol). The difference is that **glycolysis** accomplishes a negative $\Delta G^{\circ\prime}$ while yielding reducing equivalents (2 NADH) and 2 net ATP, but the biosynthetic **gluconeogenesis** pathway requires use of 4 ATP and 2 GTP to achieve its overall negative $\Delta G^{\circ\prime}$.

See also: [Gluconeogenesis Precursors](#), [Gluconeogenesis Substrates](#), [Gluconeogenesis Enzymes](#), [Regulation of Gluconeogenesis](#)

Figure 16.3: Reactions of glycolysis and gluconeogenesis.

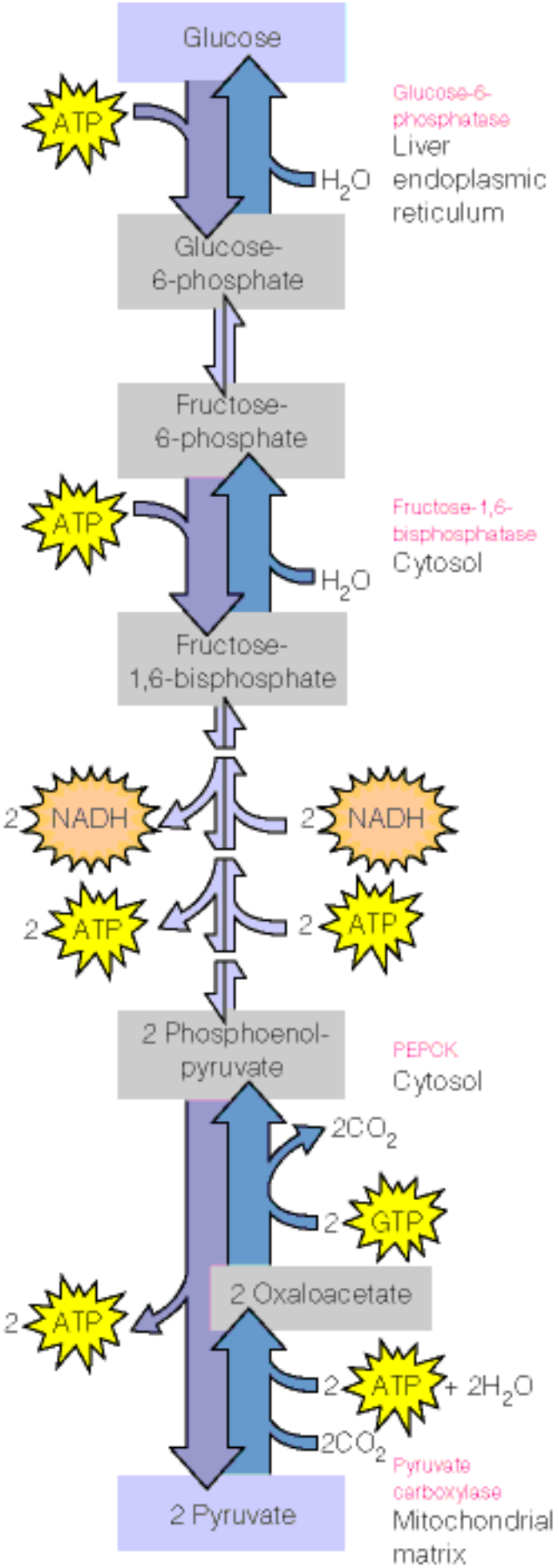

2 Pyruvate

Pyruvate
carboxylase
Mitochondrial
matrix

Net:

+ 2ATP + 2NADH

Net:

- 4ATP - 2GTP - 2NADH

Table 16.1

Reaction		ΔG° (kJ/mol)
Pyruvate + CO₂ + ATP + H₂O \longrightarrow oxaloacetate + ADP + P_i + 2H⁺	× 2	-4.2
Oxaloacetate + GTP \rightleftharpoons phosphoenolpyruvate + CO₂ + GDP	× 2	+5.8
Phosphoenolpyruvate + H ₂ O \rightleftharpoons 2-phosphoglycerate	× 2	-3.4
2-Phosphoglycerate \rightleftharpoons 3-phosphoglycerate	× 2	-9.2
3-Phosphoglycerate + ATP \rightleftharpoons 1,3-bisphosphoglycerate + ADP	× 2	+37.6
1,3-Bisphosphoglycerate + NADH + H ⁺ \rightleftharpoons glyceraldehyde-3-phosphate + NAD ⁺ + P _i	× 2	-12.6
Glyceraldehyde-3-phosphate \rightleftharpoons dihydroxyacetone phosphate		-7.6
Glyceraldehyde-3-phosphate + dihydroxyacetone phosphate \rightleftharpoons fructose-1,6-bisphosphate		-23.9
Fructose-1,6-bisphosphate + H₂O \longrightarrow fructose-6-phosphate + P_i		-16.3
Fructose-6-phosphate \rightleftharpoons glucose-6-phosphate		-1.7
Glucose-6-phosphate + H₂O \longrightarrow glucose + P_i		-12.1
Net: 2 Pyruvate + 4ATP + 2GTP + 2NADH + 6H₂O \longrightarrow glucose + 4ADP + 2GDP + 6P_i + 2NAD⁺ + 2H⁺		-47.6

Note: The reactions in boldface type are those that bypass irreversible glycolytic reactions; the remaining reactions are reversible reactions of glycolysis. The first six reactions are multiplied by 2, because 2 three-carbon precursors are required to make one molecule of glucose.

Molecular Intermediates of Gluconeogenesis



The molecular intermediates in the **gluconeogenesis** pathway are listed below. Note that with the exception of oxaloacetate, all of the intermediates are also common to glycolysis.

Pyruvate

Oxaloacetate

Phosphoenolpyruvate

2-Phosphoglycerate

3-Phosphoglycerate

1,3-Bisphosphoglycerate

DHAP + G3P

Fructose-1,6-Bisphosphate

Fructose-6-Phosphate

Glucose-6-Phosphate

Glucose

See also: [Gluconeogenesis](#), [Enzymes of Gluconeogenesis](#), [Regulation of Gluconeogenesis and Glycolysis](#), [Glycolysis](#)

Heart Metabolism

The **heart** uses a variety of fuels-mainly [fatty acids](#) but also [glucose](#), [lactate](#), and [ketone bodies](#). Metabolism of **heart** muscle differs from that of skeletal muscle in three important respects.

1. The variation in work output is far less than that seen in skeletal muscle. That is, the **heart** must work steadily and continuously in order to keep the organisms alive.
2. The **heart** is a completely aerobic tissue, whereas skeletal muscle can function anaerobically for limited periods. Mitochondria are much more densely packed in **heart** than in other cells, making up nearly half the volume of a **heart** cell.
3. The **heart** contains negligible energy reserves as [glycogen](#) or lipid, although there is a small amount of [creatine phosphate](#).

The supply of both oxygen and fuels from the blood to the heart must be continuous to meet its unending energy demands.

See also: [Biological Fuel](#), [Muscle Metabolism](#), [Figure 23.4](#)

Adipose Tissue Metabolism

Adipose tissue is the major fuel storage tissue for an animal. The total stored **triacylglycerols** amount to some 565,000 kJ (135,000 kcal) in an average-sized human. This is enough fuel, metabolic complications aside, to sustain life for a couple of months in the absence of further caloric intake.

The **adipocyte**, or **fat cell**, is designed for continuous synthesis and breakdown of triacylglycerols, with breakdown controlled largely via the activation of **hormone-sensitive lipase**. Because adipocytes lack the enzyme **glycerol kinase**, some **glucose** catabolism must occur for triacylglycerol synthesis to take place--specifically, the formation of **dihydroxyacetone phosphate**, for reduction to **glycerol-3-phosphate** (see [here](#)).

Glucose acts as a sensor in adipose tissue metabolism. When glucose levels are adequate, the production of dihydroxyacetone phosphate generates enough glycerol-3-phosphate for the resynthesis of triacylglycerols from the released **fatty acids**. When intracellular glucose levels fall, the concentration of glycerol-3-phosphate falls also, and fatty acids are released from the adipocyte as the **albumin** complex for export to other tissues).

See also: [Biological Fuel](#), [Figure 23.4](#)

Blood Metabolism

Glycolysis in the erythrocyte is the most prominent pathway in the energy metabolism of **blood**. **Blood** cells constitute nearly half the volume of **blood**, and erythrocytes constitute more than 99% of **blood** cells. Mammalian erythrocytes contain no mitochondria and depend exclusively upon **anaerobic glycolysis** to meet their energy needs.

Blood also plays a role in transporting compounds metabolized in other tissues as follows:

1. **Blood** transports waste products/fuels. The bloodstream transports what may be one organ's waste product but another organ's fuel (for example, lactate from muscle to liver).
2. **Blood** transports oxygen from lungs to tissues, enabling exergonic oxidative pathways to occur, followed by transport of the resultant CO₂ back to the lungs for exhalation.
3. The lipoprotein components of **blood** plasma play indispensable roles in transporting lipids.
4. **Blood** is also the medium of transport of hormonal signals from one tissue to another, and of exit for metabolic end products, such as urea, via the kidneys.

See also: **Biological Fuel**

Homogentisic Acid

Homogentisic acid is a substance that accumulates in the hereditary disease, alkaptonuria, due to a deficiency of the enzyme **homogentisic acid dioxygenase**. In the disease, **homogentisic acid** is excreted in large amounts in the urine where it oxidizes on standing, causing the urine to become dark.

See also: [Aromatic Amino Acid Utilization](#), [Metabolism of Aromatic Amino Acids and Histidine](#), [Neurotransmitters and Biological Regulators](#)

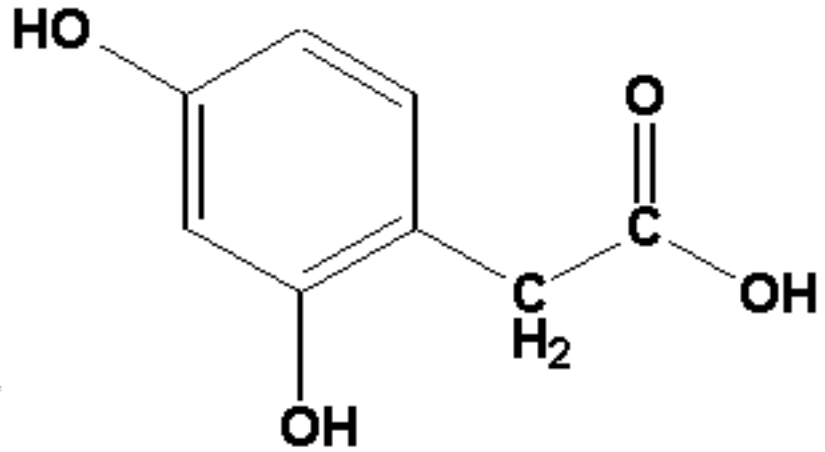

Homogentisic Acid

Figure 21.22: Metabolic fates of tryptophan.

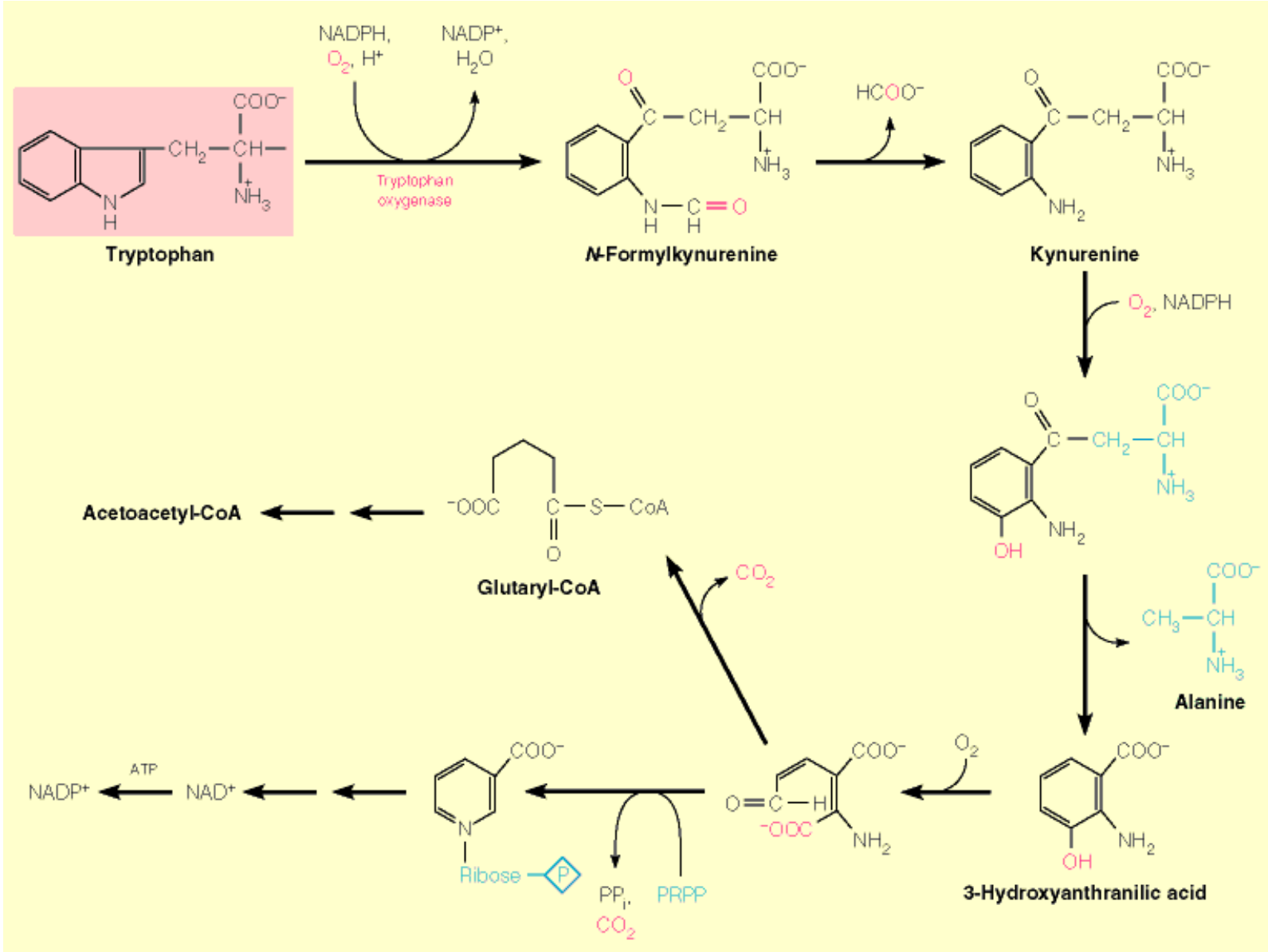

Glutaryl-CoA



Glutaryl-CoA is a product of tryptophan catabolism (Figure 21.22).

See also: Aromatic Amino Acid Utilization

INTERNET LINK: Tryptophan Metabolism

Figure 21.23: Catabolism of histidine.

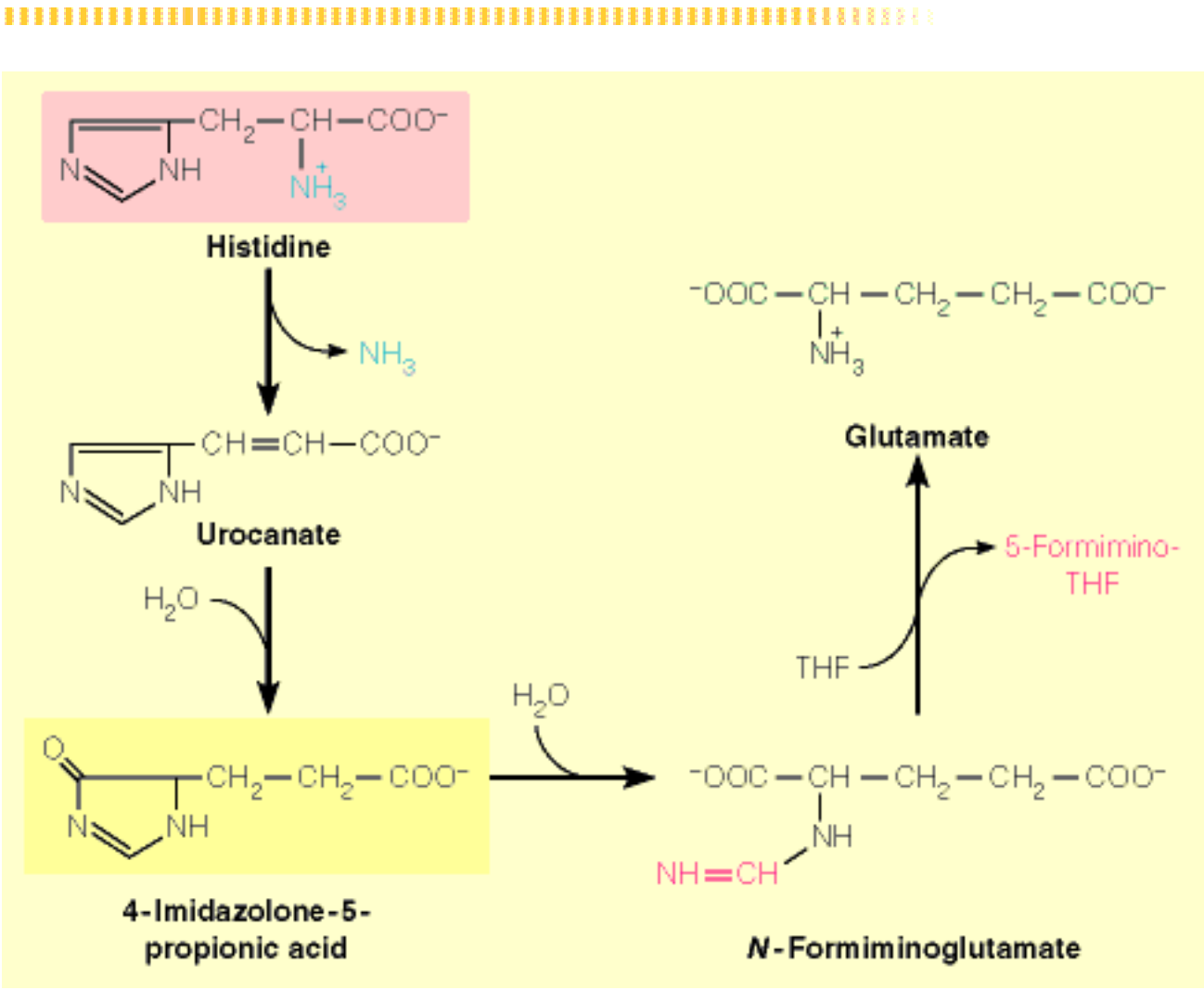

γ -Carboxyglutamic Acid

γ -Carboxyglutamic acid is a modified [amino acids](#) formed from glutamate by a [vitamin K](#)-stimulated reaction. The modification allows a protein to bind calcium, which is an essential event in the blood clotting cascade.

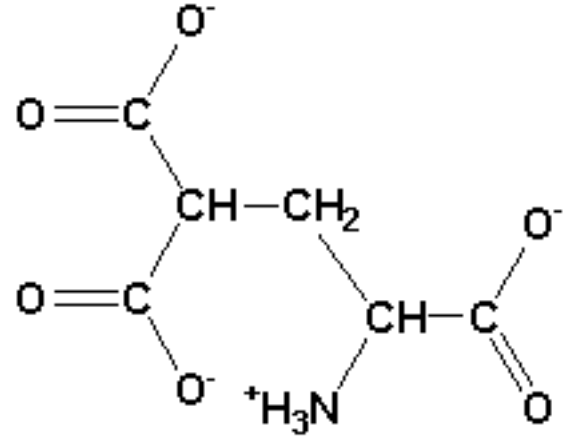

Gamma carboxyglutamic acid

See also: [Glutamic Acid](#), [Blood Clotting](#) (from Chapter 11),

Polyamines

Figure 21.10 depicts the synthesis of the **polyamines** [putrescine](#), [spermidine](#), and [spermine](#).

Polyamines are polycationic substances that stabilize intracellular conformations of negatively charged nucleic acids. **Polyamines** bind to phosphates on both strands of a duplex nucleic acid, thereby stabilizing double-stranded DNA or a duplex region of RNA.

Some proteins covalently bond **polyamines**, with the nitrogens linked to glutamate- γ -carboxyl groups.

Putrescine is a precursor to spermidine and spermidine yields spermine through the AdoMet-mediated transfer of active propylamino groups ([Figure 21.10](#)).

Polyamine biosynthesis is closely related to the proliferative state of the cell. When nucleic acid synthesis is activated, so is **polyamine** synthesis.

See also: [Metabolism of Ornithine and Arginine](#), [S-Adenosylmethionine and Biological Methylations](#), [AdoMet](#)

Figure 21.10: Biosynthesis of putrescine, spermidine, and spermine.

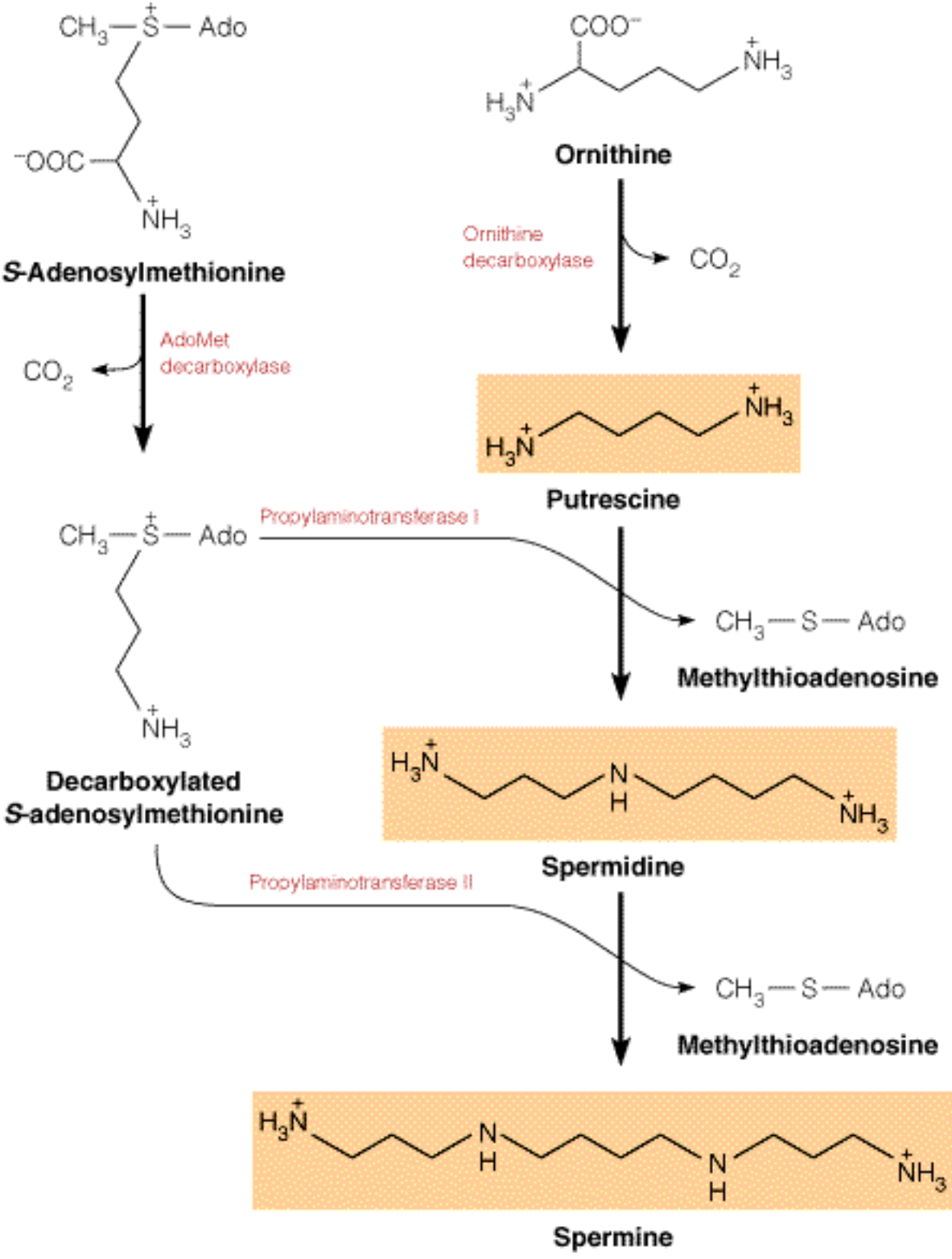

Putrescine (1,4-Diaminobutane)

Figure 21.10 depicts synthesis of **putrescine**, **spermidine**, and **spermine** from **ornithine**.

Putrescine is synthesized by decarboxylation of ornithine and it derives its name from the fact it was originally isolated from rotting meat. **Putrescine** is a precursor to spermidine, then to spermine through the **AdoMet**-mediated transfer of active propylamino groups

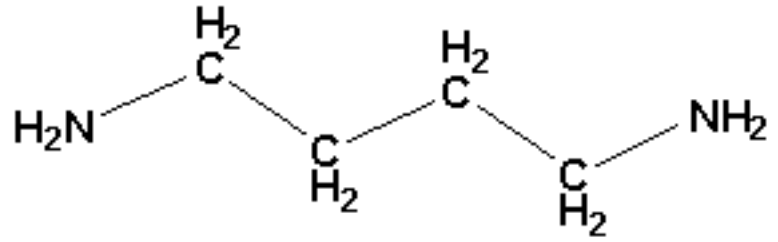

Putrescine (1,4-diaminobutane)

See also: [Polyamines](#), [Metabolism of Ornithine and Arginine](#)

Spermidine

Figure 21.10 depicts synthesis of **putrescine**, **spermidine**, and **spermine** from **ornithine**. The polyamines are polycationic substances that stabilize intracellular conformations of negatively charged nucleic acids. Polyamines bind to phosphates on both strands of a duplex nucleic acid, thereby stabilizing double-stranded DNA or a duplex region of RNA.

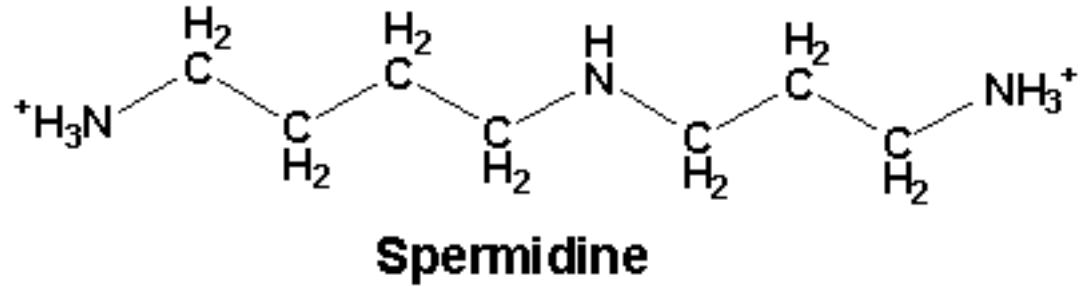

Some proteins covalently bind polyamines, with the nitrogens linked to glutamate- γ -carboxyl groups.

Putrescine is a precursor to **spermidine**, which is subsequently converted to spermine through the **AdoMet**-mediated transfer of active propylamino groups (**Figure 21.10**).

Polyamine biosynthesis is closely related to the proliferative state of the cell. When nucleic acid synthesis is activated, so is **polyamine** synthesis.

See also: [Metabolism of Ornithine and Arginine](#), [S-Adenosylmethionine and Biological Methylations](#), [Polyamines](#)

Spermine

Figure 21.10 depicts synthesis of **putrescine**, **spermidine**, and **spermine** from **ornithine**. The **polyamines** are polycationic substances that stabilize intracellular conformations of negatively charged nucleic acids. Polyamines bind to phosphates on both strands of a duplex nucleic acid, thereby stabilizing double-stranded DNA or a duplex region of RNA.

Some proteins covalently bind polyamines, with the nitrogens linked to glutamate- γ -carboxyl groups.

Putrescine is a precursor to spermidine, then to **spermine** through the **AdoMet**-mediated transfer of active propylamino groups (**Figure 21.10**).

Polyamine biosynthesis is closely related to the proliferative state of the cell. When nucleic acid synthesis is activated, so is polyamine synthesis.

See also: [Metabolism of Ornithine and Arginine](#), [S-Adenosylmethionine and Biological Methylations](#), [Polyamines](#)

Metabolism of Ornithine and Arginine

In the urea cycle, [ornithine](#) leads to **arginine** and urea. **Ornithine** can also be decarboxylated to yield 1,4-diaminobutane(see [here](#)), a precursor to polyamines. 1,4-Diaminobutane is also known as putrescine because it was originally isolated from rotting meat.

Arginine is a precursor to nitric oxide, a novel second messenger and neurotransmitter. The complex conversion of **arginine** to citrulline and nitric oxide is shown in [Figure 21.3](#) as is the conversion of **arginine** to creatine phosphate.

In summary:

Ornithine leads to [arginine](#) (in the [urea cycle](#));

Ornithine can be decarboxylated to yield [putrescine](#) (see [Figure 21.10](#) and [here](#));

[Putrescine](#) is a precursor to [polyamines](#);

Arginine is a precursor to [nitric oxide](#) and [citrulline](#) ([Figure 21.3](#)); and

Arginine can be converted to [creatine phosphate](#) ([Figure 21.3](#)).

See also: [Actions of Nitric Oxide](#), [S-Sadenosylmethionine and Biological Methylation](#), [Polyamines](#)

Unnumbered Item

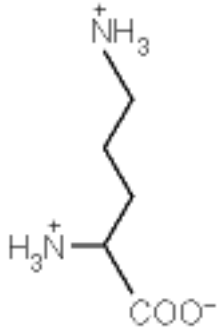

Ornithine

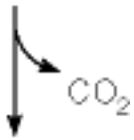

Putrescine

Unnumbered Item

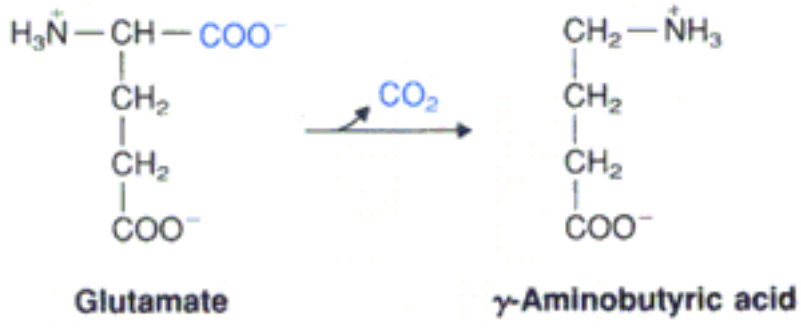
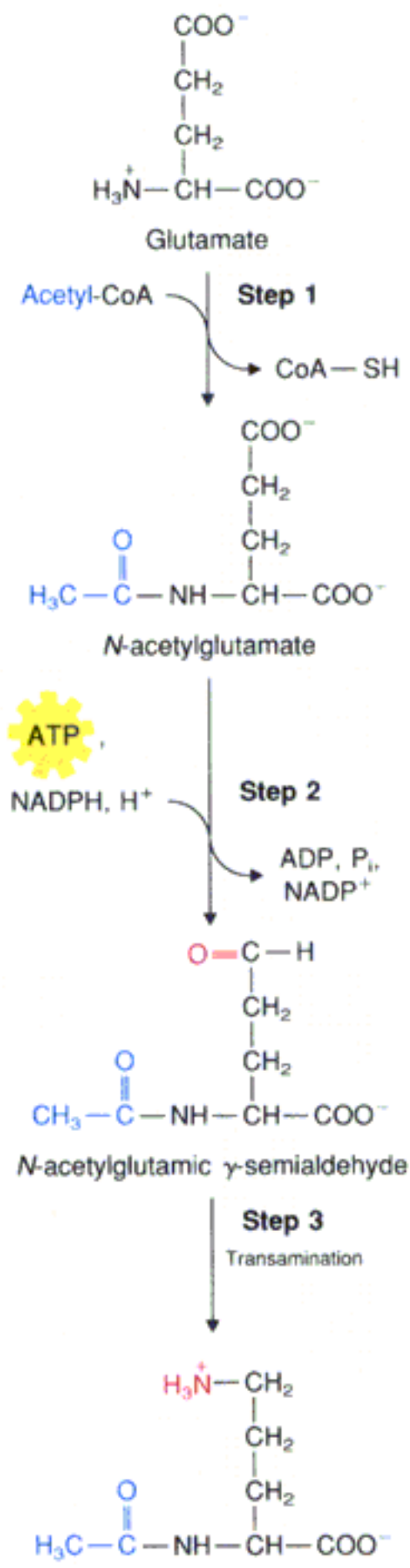
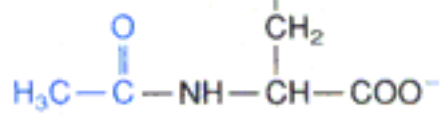
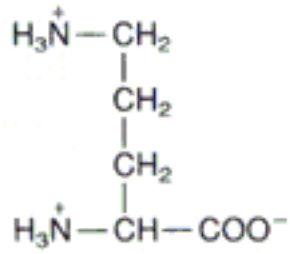
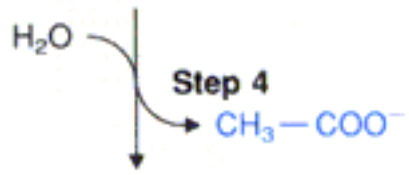

Figure 21.2: Biosynthesis of ornithine from glutamate.





N-acetylornithine



Ornithine

Glutamic- γ -Semialdehyde

Figure 21.2, illustrates conversion of **glutamate** to **ornithine** (a **urea cycle** intermediate). Formation of the intermediate, **glutamic- γ -semialdehyde**, is comparable to the reduction of **aspartate** to **aspartic semialdehyde**. **Glutamic- γ -semialdehyde** leads to the biosynthesis of **proline** (see **here**).

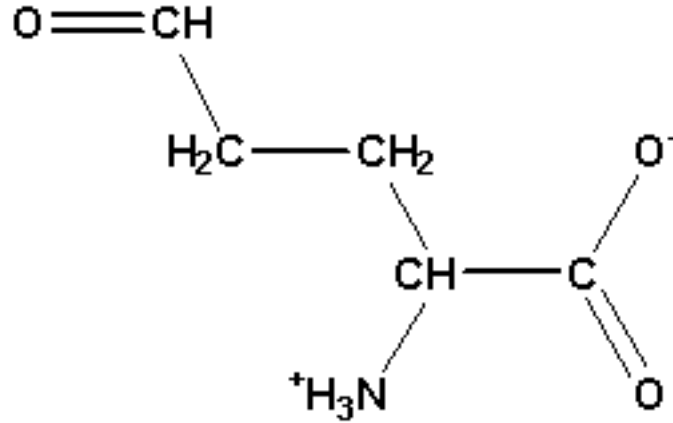

Glutamate-gamma-Semialdehyde

See also: **Metabolism of Ornithine and Arginine**

Unnumbered Item

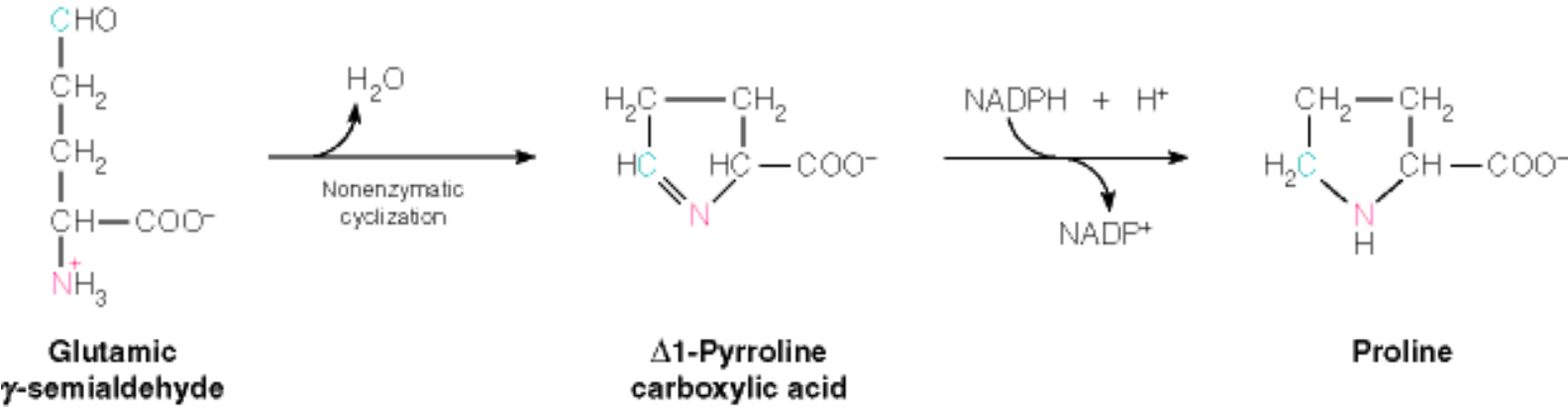

Procollagen Proline Hydroxylase



Proline is incorporated into polypeptide precursors of **collagen**. In the procollagen polypeptide (precursor to the mature collagen), proline is converted to **hydroxyproline** by the enzyme **procollagen proline hydroxylase** (**Figure 21.4**). As seen in the figure, the reaction requires ascorbic acid (**vitamin C**).

See also: [Modified Amino Acids in Proteins](#)

6-Methylpterin

In the structure of the vitamin [folic acid](#), **6-methylpterin** is linked through the amino group of p-aminobenzoic acid ([PABA](#)) to form [pteroic acid](#), which is linked in turn via an amide to [glutamate](#), to form pteroylmonoglutamate.

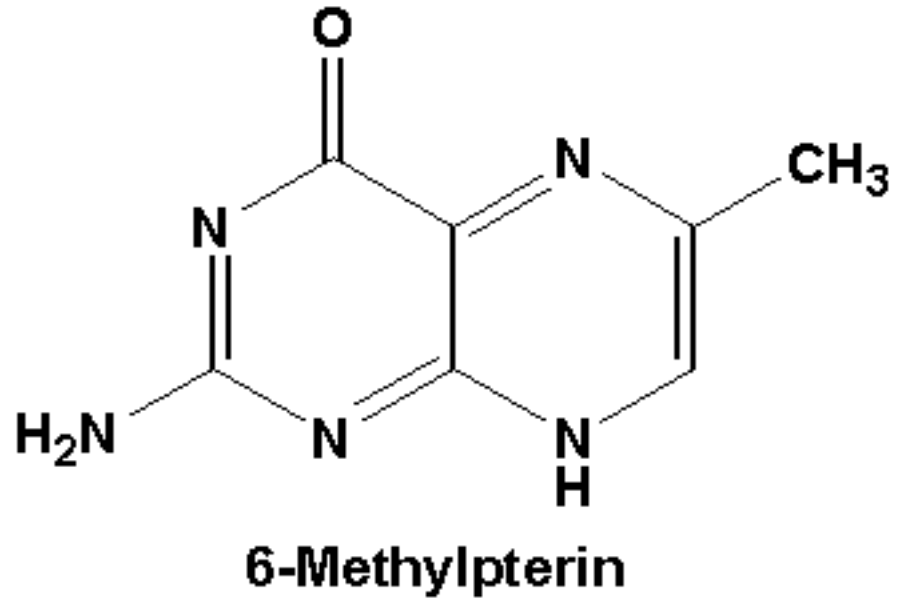

See also: [Glutamate as a Precursor to Other Amino Acids](#)

Pterotic Acid

In the structure of the vitamin **folic acid**, **6-methylpterin** is linked through the amino group of p-aminobenzoic acid (**PABA**) to form **pterotic acid**, which is linked in turn via an amide to **glutamate**, to form pteroylmonoglutamate.

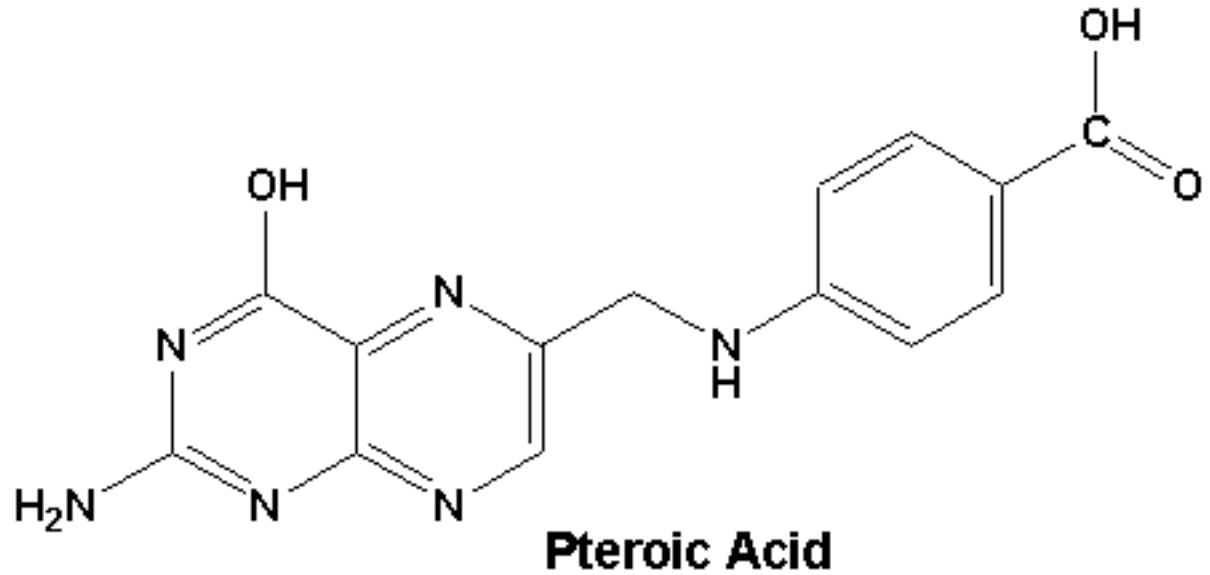

See also: [Glutamate as a Precursor to Other Amino Acids](#)

O⁶-Alkylguanine Alkyltransferase

Alkylating reagents cause damage to DNA similar to that induced by ultraviolet irradiation in that various modified DNA bases are formed, some of which are lethal if not repaired and some of which are mutagenic. Three methylating or ethylating reagents are shown [here](#).

The bases altered by these reagents are primarily purines (phosphate oxygens are also targets), and the spectrum of products formed varies with the reagent used. The most highly mutagenic of these products, [O⁶-alkylguanine](#), is mutagenic because the modified base has a very high probability of pairing with [thymine](#) when the modified strand replicates ([Figure 25.11](#)). Thus, alkylation of a DNA-guanine stimulates a GC ---> AT transition.

Repair of this type of damage involves an unusual enzyme, **O⁶-alkylguanine alkyltransferase**, which transfers a methyl or ethyl group from an O⁶-methylguanine or O⁶-ethylguanine residue to a [cysteine](#) residue in the active site of the protein. Thus, **O⁶-alkylguanine alkyltransferase** (like photoreactivation) directly changes damaged bases rather than removing them then replacing them.

Remarkably, **O⁶-alkylguanine alkyltransferase** is a catalyst that can function only once. Having become alkylated, it cannot remove the alkyl group, and the protein molecule turns over. Thus, this compound is not really an enzyme after all.

In bacteria **O⁶-alkylguanine alkyltransferase** regulates both its own transcription and that of another repair enzyme, a DNA-N-glycosylase. There is evidence that the alkylated form of the **alkyltransferase** is the specific form of the transcriptional activator. This allows the cell to adapt to alkylation damage by using the alkylated protein as a specific signal to produce more of the proteins needed to repair the damage.

See also: [Types and Consequences of DNA Damage](#), [Photoreactivation](#)

INTERNET LINK: [DNA Repair](#)

Unnumbered Item

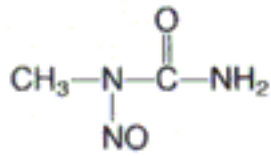

Methylnitrosourea (MNU)

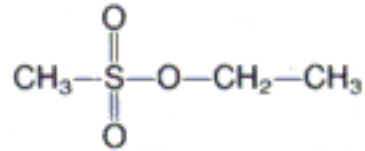

Ethylmethanesulfonate (EMS)

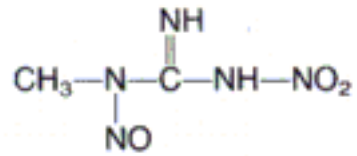

***N*-Methyl-*N'*-nitro-*N*-nitrosoguanidine (MNNG)**

O⁶-Alkylguanine

O⁶-alkylguanine is an alkylating agent that is a chemical mutagen - a substance that can cause mutations in DNA. DNA that has been alkylated with **O⁶-alkylguanine** is mutagenic because the modified base has a very high probability of pairing with **thymine** when the modified strand replicates (**Figure 25.11**). Thus, alkylation of a DNA-guanine stimulates a GC → AT transition.

The enzyme **O⁶-alkylguanine alkyltransferase** repairs DNA damaged by **6-alkylguanine**.

See also: [Types and Consequences of DNA Damage](#), [Photoreactivation](#)

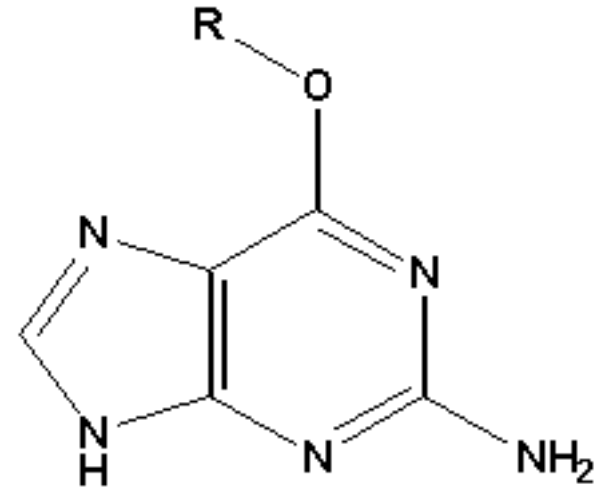

O⁶-alkylguanines

Figure 25.11: Mispairing of O⁶-methylguanine with thymine in a DNA duplex.

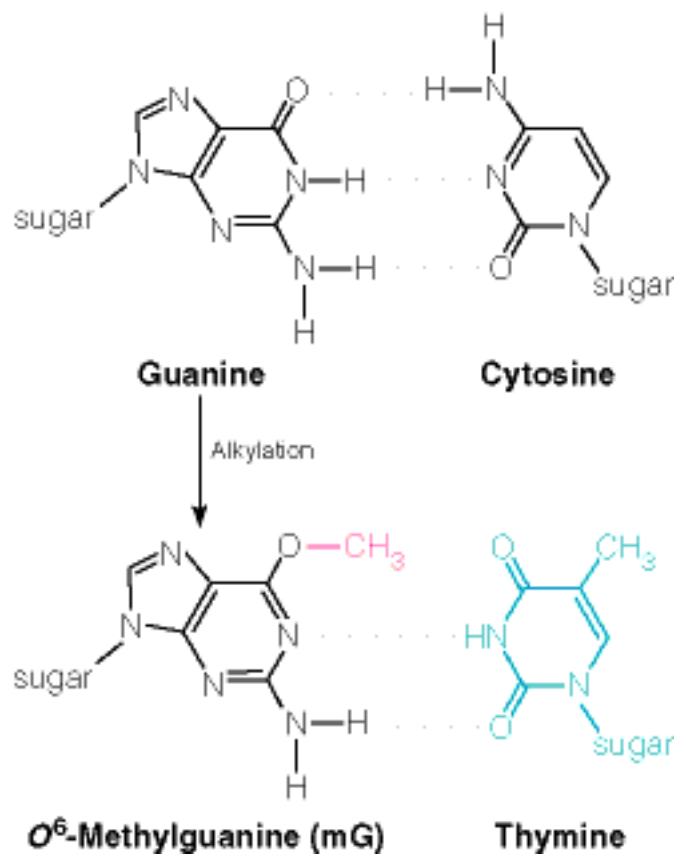

Trimethoprim

Trimethoprim is an inhibitor of the enzyme **dihydrofolate reductase**. Because it inhibits the enzyme, **tetrahydrofolate** cannot be regenerated and *de novo* synthesis of **thymidine** is stopped.

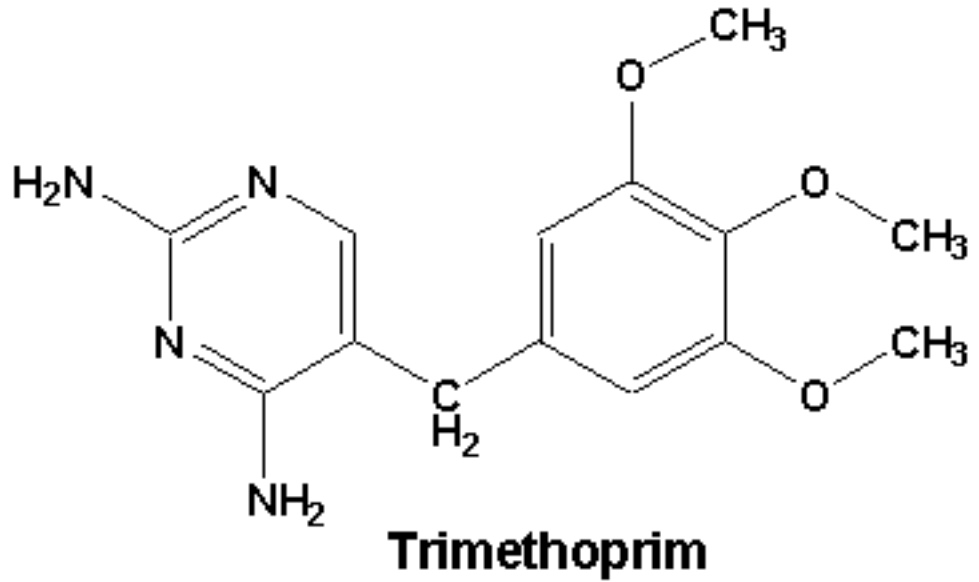

See also: [Biosynthesis of Thymine Deoxyribonucleotides](#), [Figure 22.18](#)

Nucleotide Analogs in Selection

Selectable genetic markers - Modified nucleotides can be used to select cells containing or lacking specific enzymes. Examples include the following:

6-Thioguanine - selects for cells lacking an active hypoxanthine-guanine phosphoribosyltransferase (**HGPRT**). Cells containing an active enzyme convert **6-thioguanine** to a toxic compound.

5-Bromodeoxyuridine (BrdUrd) - can be used to select cells lacking **thymidine kinase**, which is needed to metabolize BrdUrd to a toxic metabolite.

HAT Selection - The compounds **hypoxanthine**, aminopterin (see [here](#)), and **thymidine** (H,A, and T, respectively) can be used to select for cells having functional salvage pathways. Aminopterin inhibits **dihydrofolate reductase**, which blocks **de novo purine** and **thymidine synthesis**. Only cells which can utilize **thymidine** (pyrimidine salvage) and **hypoxanthine** (**purine salvage**) can grow in this medium.

See also: [Drug Design](#), [Salvage Routes to Deoxyribonucleotide Synthesis](#), [Excessive Uric Acid in Purine Degradation](#), [Biosynthesis of Thymine Deoxyribonucleotides](#)

6-Thioguanine

6-Thioguanine is a compound that selects for cells lacking an active hypoxanthine-guanine phosphoribosyltransferase (**HGPRT**). It accomplishes this because cells containing an active HGPRT enzyme convert **6-thioguanine** to a toxic compound.

See also: [Nucleotide Analogs in Selection](#)

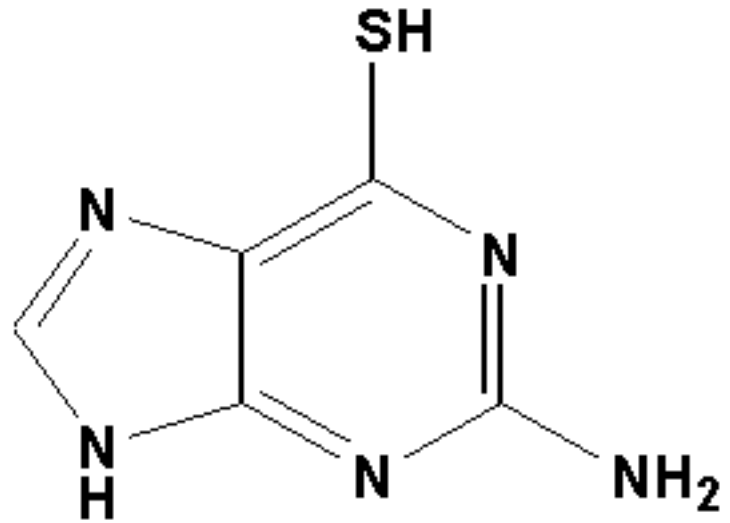

6-Thioguanine

5-Bromodeoxyuridine (BrdUrd)

5-Bromodeoxyuridine (BrdUrd) is a nucleotide analog that can be used to select cells lacking **thymidine kinase**. Cells containing a normal, functioning thymidine kinase convert **BrdUrd** to a toxic compound.

See also: [Nucleotide Analogs in Selection](#),

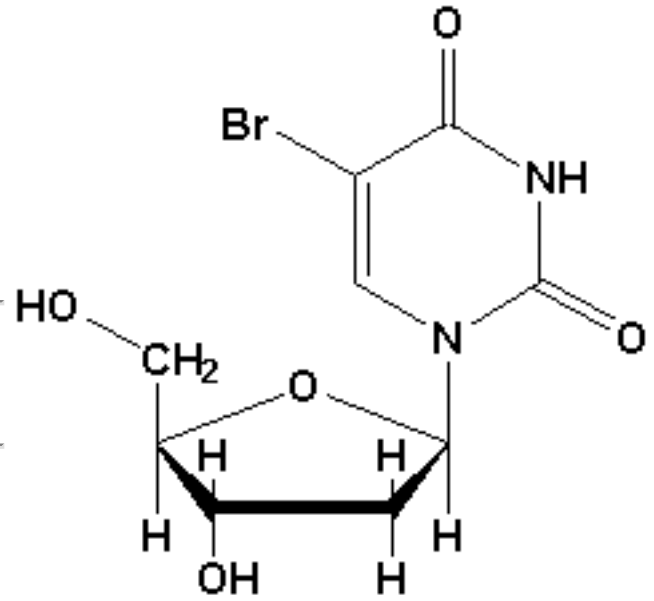

5-Bromodeoxyuridine (BrdUrd)

dCMP Deaminase



dCMP deaminase is an enzyme in nucleotide biosynthesis that catalyzes the following reaction:

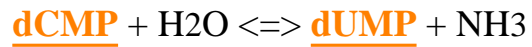

The enzyme is activated by dCTP and inactivated by dTTP.

See also: [Figure 22.17](#), [Ribonucleotide Reductase and Deoxyribonucleotide Biosynthesis](#), [Deoxyuridine Nucleotide Metabolism](#), [Salvage Routes to Deoxyribonucleotide Synthesis](#), [Nucleotide Analogs in Selection](#).

Figure 4.4: Tautomerization of the bases.

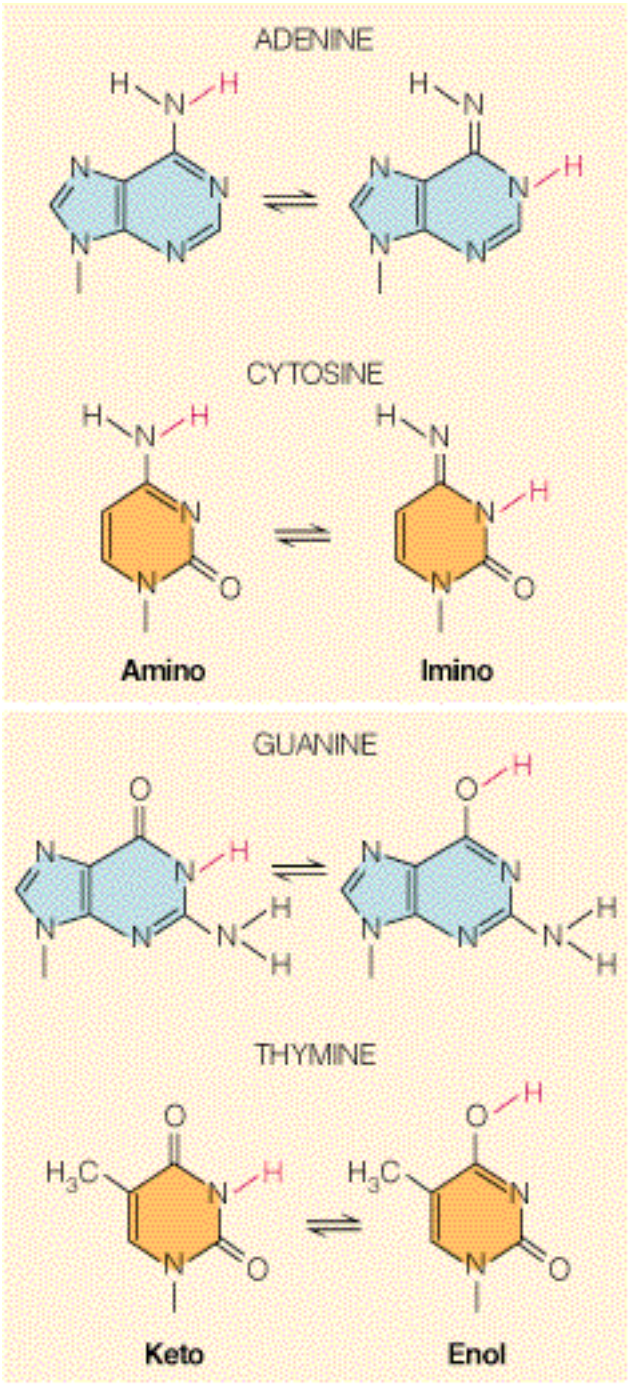
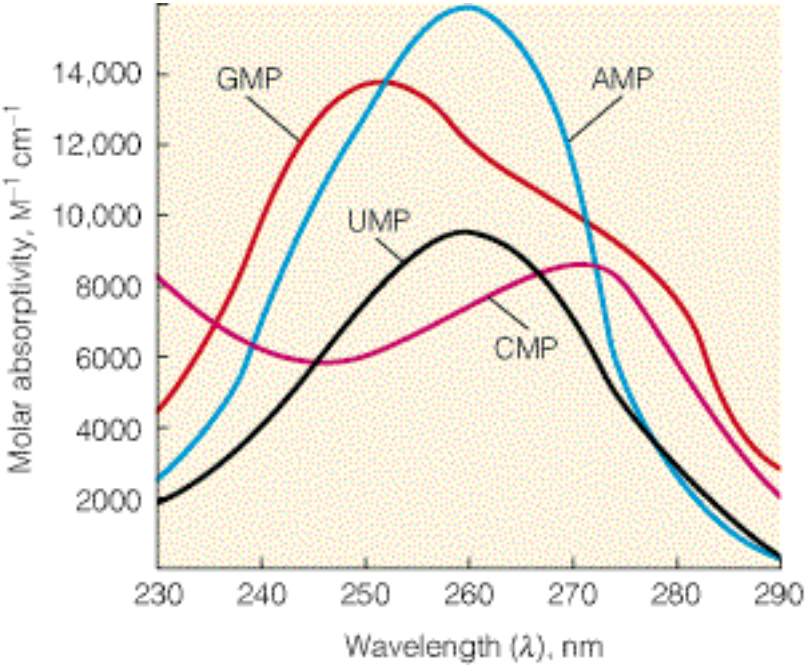

Figure 4.5: Ultraviolet spectra of ribonucleotides.



Data from A. L. Lehninger, D. L. Nelson, and M. M. Cox, Principles of Biochemistry, 2nd ed. (New York: Worth, 1993), p. 330, 12.10. © 1993, 1982 by Worth Publishers, Inc. Used with permission.

Primary, Secondary, and Tertiary Structure of Nucleic Acids

Primary, Secondary, Tertiary Structure of [Nucleic Acids](#)

1. The **primary structure** is the sequence of nucleoside monophosphates (usually written as the sequence of bases they contain).
2. The **secondary structure** refers to the shape a nucleic acid assumes as a result of the **primary structure**. B-DNA, A-DNA, and Z-DNA are forms of **secondary structure** (see [here](#) and [here](#)). B-DNA is the form that predominates in the aqueous environment of the cell.
3. **Tertiary structure** refers to large-scale folding in a linear polymer that is at a higher order than **secondary structure**. The **tertiary structure** is the specific three-dimensional shape into which an entire chain is folded.

See also: [B-DNA](#), [Polynucleotide Structures](#), [DNA](#), [RNA](#), [Palindromes](#)

Figure 4.26: Z-DNA.

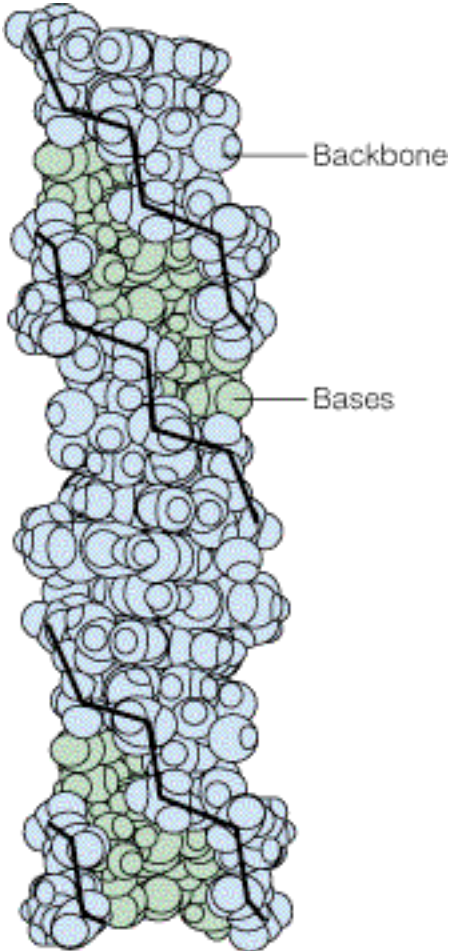

Courtesy of Dr. A. H.-J. Wang from Cold Spring Harbor Symp. Quant. Biol. (1982) 47:41.

Palindromes

With respect to [DNA](#), a **palindrome** is a segment in which the sequence is the same on one strand read right to left as on the other strand read left to right; thus, a back-to-back pair of inverted repeats.

For example, the double-stranded sequence below,

```
GGCGCGCC  
CCGCGCGG
```

is a **palindrome**. Note that the standard definition of a **palindrome** (a word or phrase that reads the same backwards or forwards - e.g., RADAR) is slightly different than the way the term is used here.

See also: [Figure 4.28](#), [Nucleic Acid Sequences](#)

Figure 4.28: A palindromic DNA sequence.

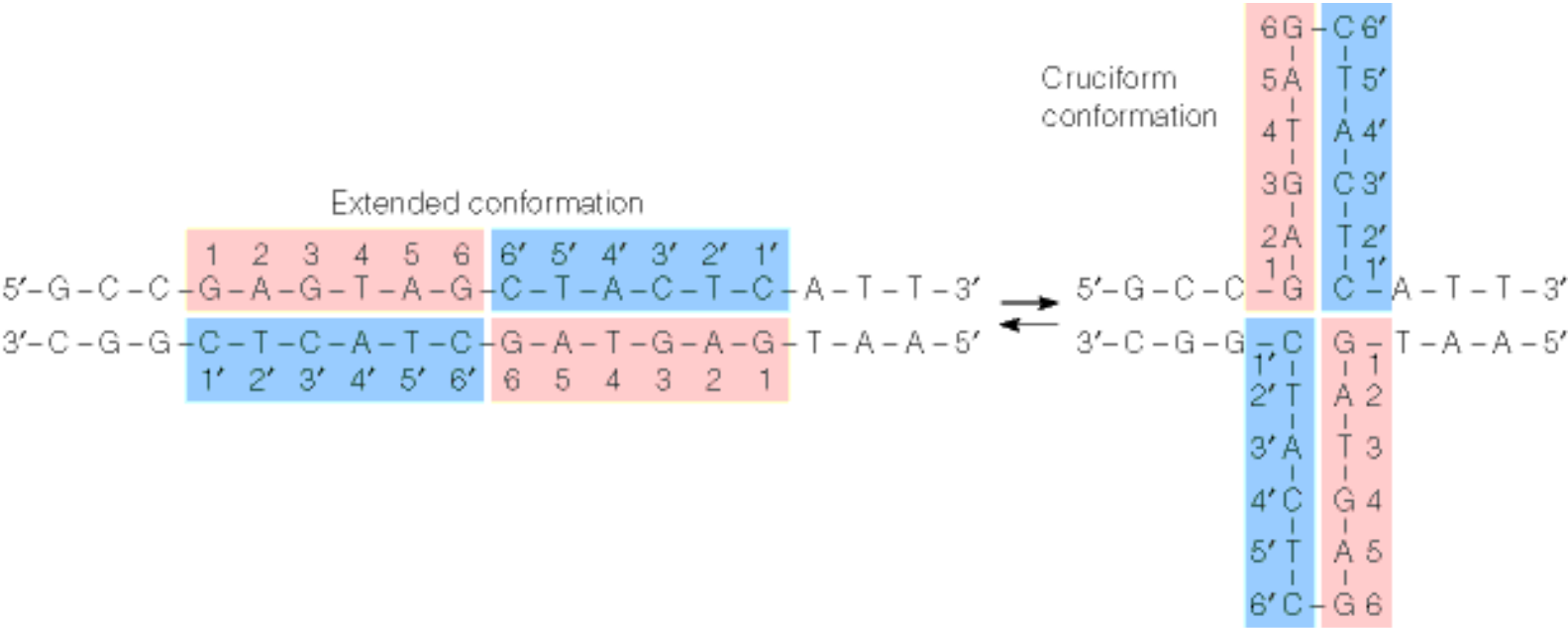

History of DNA

The **History of DNA** has been a long and interesting one. Some of the highlights include:

1. The Swiss biologist, Friedrich Miescher, isolated DNA from salmon sperm in 1868.
2. In 1944, Oswald Avery, Colin MacLeod, and Maclyn McCarty showed that DNA from pathogenic strains of the bacterium *Pneumococcus* could be transferred into nonpathogenic strains, making them (and any succeeding generations) pathogenic ([Figure 4.8a](#)).
3. Erwin Chargaff reported in 1947 that the quantities of adenine and thymine in DNA were very close to the same value. Similarly, he observed that cytosine and guanine were also very close to equal in quantity.
4. In 1952, Alfred Hershey and Martha Chase showed T2 bacteriophage inject only DNA into cells and this is sufficient to make more T2 bacteriophage ([Figure 4.8b](#)).
5. James Watson and Francis Crick proposed the model of the double helix of DNA in 1953 ([Figure 4.10](#) and [Figure 4.11](#)).
6. Matthew Meselson and Fanklin Stahl demonstrated in 1958 that DNA replication (see [here](#)) occurred by a semi-conservative mechanism (see [here](#)) in which a parental duplex yields two daughter duplexes. Each daughter duplex contains one strand from the original parental duplex and one newly synthesized strand, made by copying the parental strand.
7. In 1965, Marshall Nirenburg, Philip Leder, and others, identified the [genetic code](#) by which protein is made from information in DNA.
8. In 1979, an MIT team headed by Alexander Rich reported finding a left-handed, zig-zagging DNA strand that they named Z-DNA.

See also: [DNA](#)

INTERNET LINK: [Biotechnology Timeline Since 1977](#)

Figure 4.8: Experiments that showed DNA to be the genetic substance.

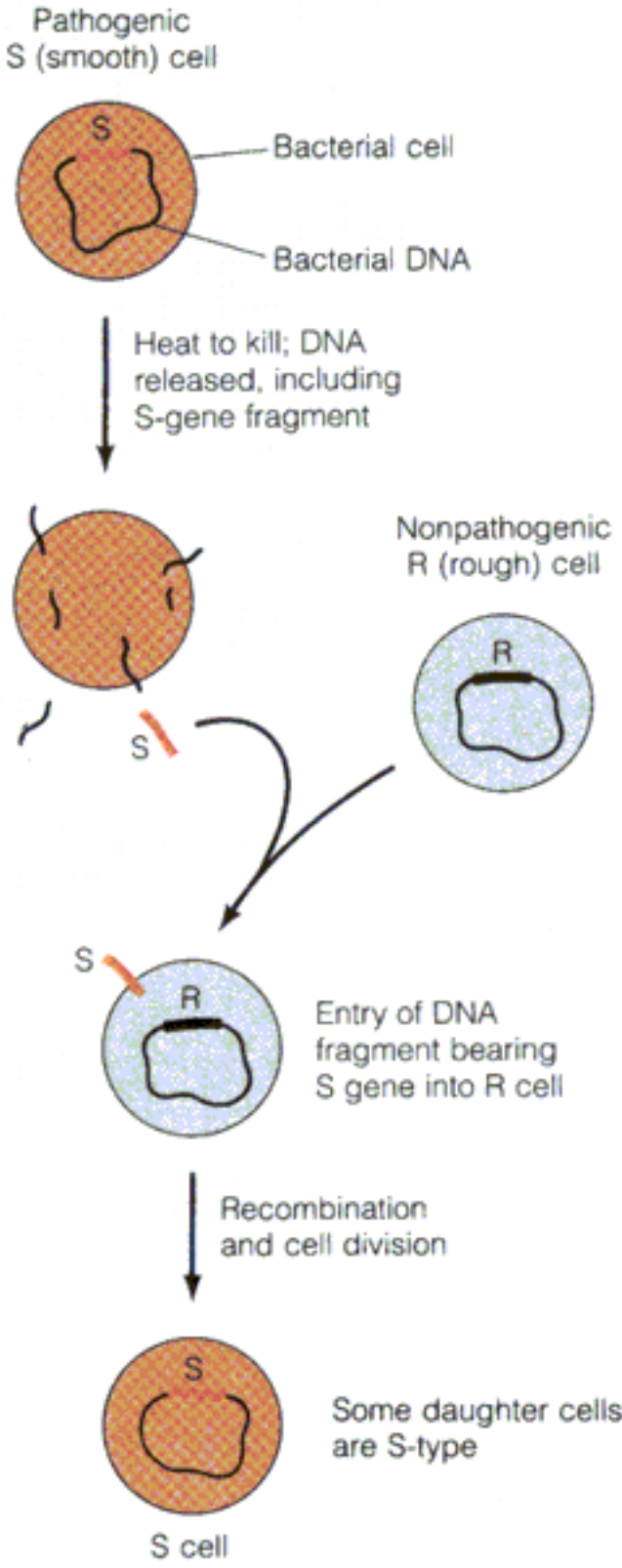

(a) Bacterial DNA alters phenotype (Avery et al.)

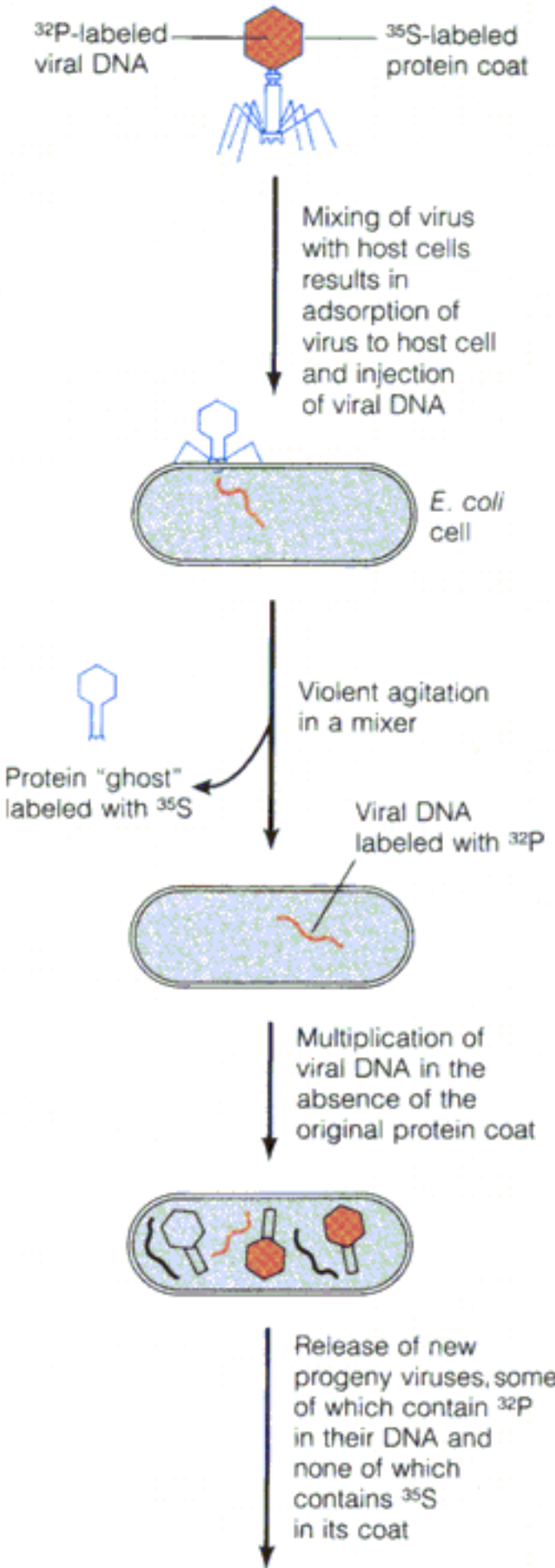

in their DNA and
none of which
contains ^{35}S
in its coat

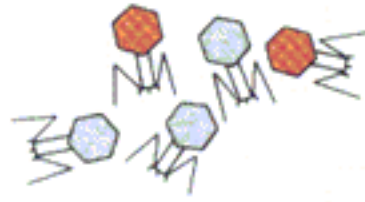

(b) Phage DNA gives rise to
 ^{32}P -labeled phages (Hershey
and Chase)

Semiconservative DNA Replication

Watson and Crick's model for the structure of **DNA** suggested that replication of the strands of DNA could be accomplished using the rules of base pairing, but did not specify the exact mechanism. Three general mechanisms were considered (**Figure 4.13**):

1. **Conservative**—From one parental double-stranded DNA, two "daughter" double-stranded DNAs are made. One contains two new strands and the other contains both of its original strands.
2. **Semi-conservative**—From one parental double-stranded DNA, two daughter double-stranded DNAs are made. Each daughter DNA contain one parental DNA strand and one newly made strand. (**Figure 4.12**)
3. **Dispersive**—From one parental double-stranded DNA, two daughter double-stranded DNAs are made. Each strand in the daughter molecules contains portions of old and newly synthesized material.

In 1958, Matthew Meselson and Franklin Stahl determined which mechanism was actually used (**Figure 4.14**) when they:

1. Grew cells for many generations in medium containing ^{15}N (a heavy isotope of nitrogen). This caused double-stranded DNA in these cells to be denser (1.724 g/mL) than normal double stranded DNA (1.710 g/mL) because the heavier nitrogen atoms were incorporated into the bases of the DNA.
2. The cells were then shifted to a medium containing the normal ^{14}N for one generation. This would allow only one round of DNA replication to take place.
3. The density of the double-stranded DNA obtained from cells after the shift to ^{14}N for one generation was midway between the density of normal and heavy DNA.
4. When cells were allowed to grow for two generations in ^{14}N medium, equal amounts of double-stranded DNA with a medium density and normal density were obtained.
5. Comparing the density of single-stranded DNA from these cells (by separating the strands at pH 12) revealed that cells grown in ^{14}N for one generation contained equal amounts of light and heavy strands.

These observations are all consistent with the **semi-conservative model of DNA replication**.

Observations 3 and 4, on the other hand, were not consistent with the conservative model of replication and observation 5 was inconsistent with the dispersive model of replication.

See also: [DNA Replication Overview](#) (from chapter 24), [DNA](#), [History of DNA](#)

INTERNET LINK: [Meselson and Stahl's Experiment](#)

Figure 4.13: Three models of DNA replication.

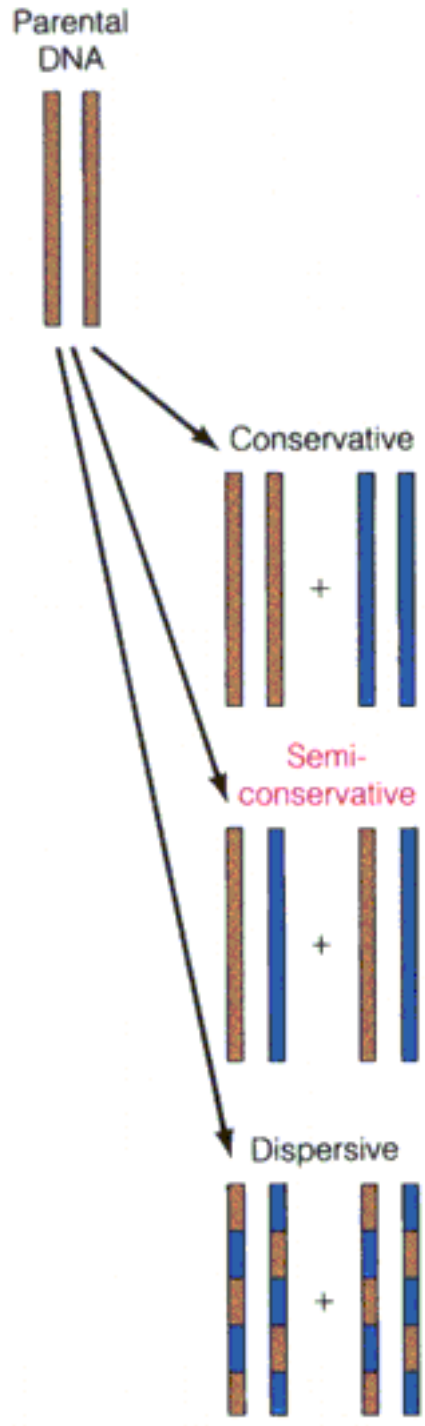

Figure 4.12: A model for DNA replication.

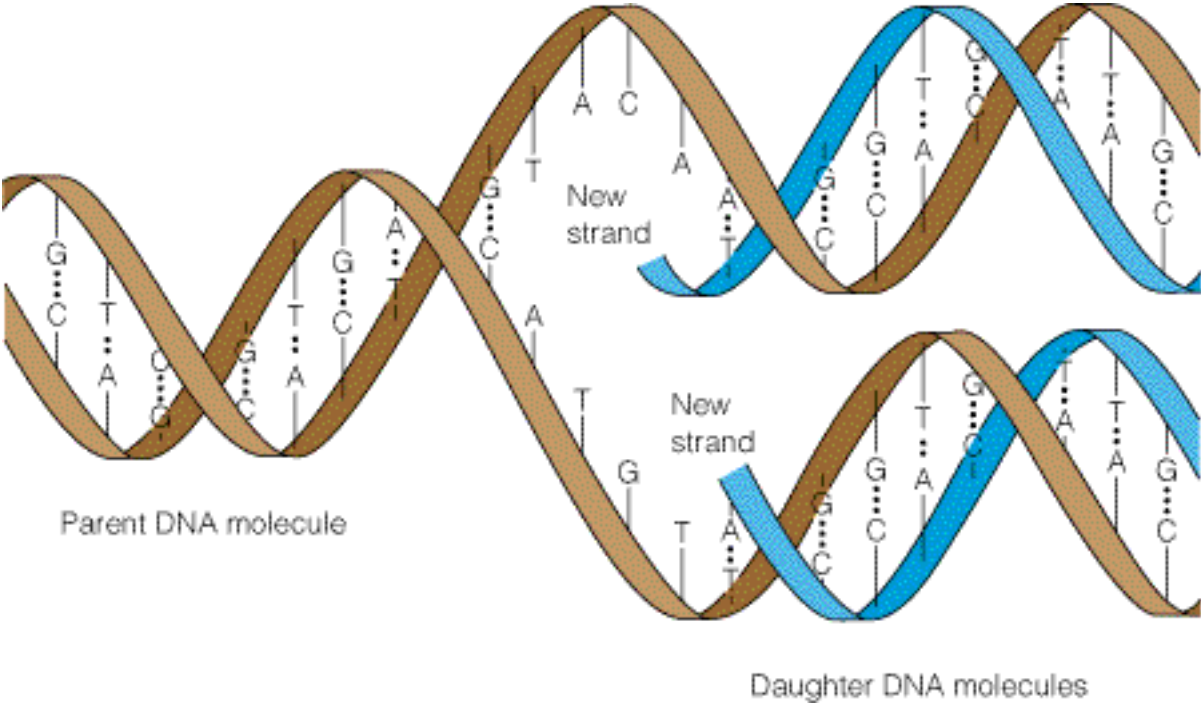
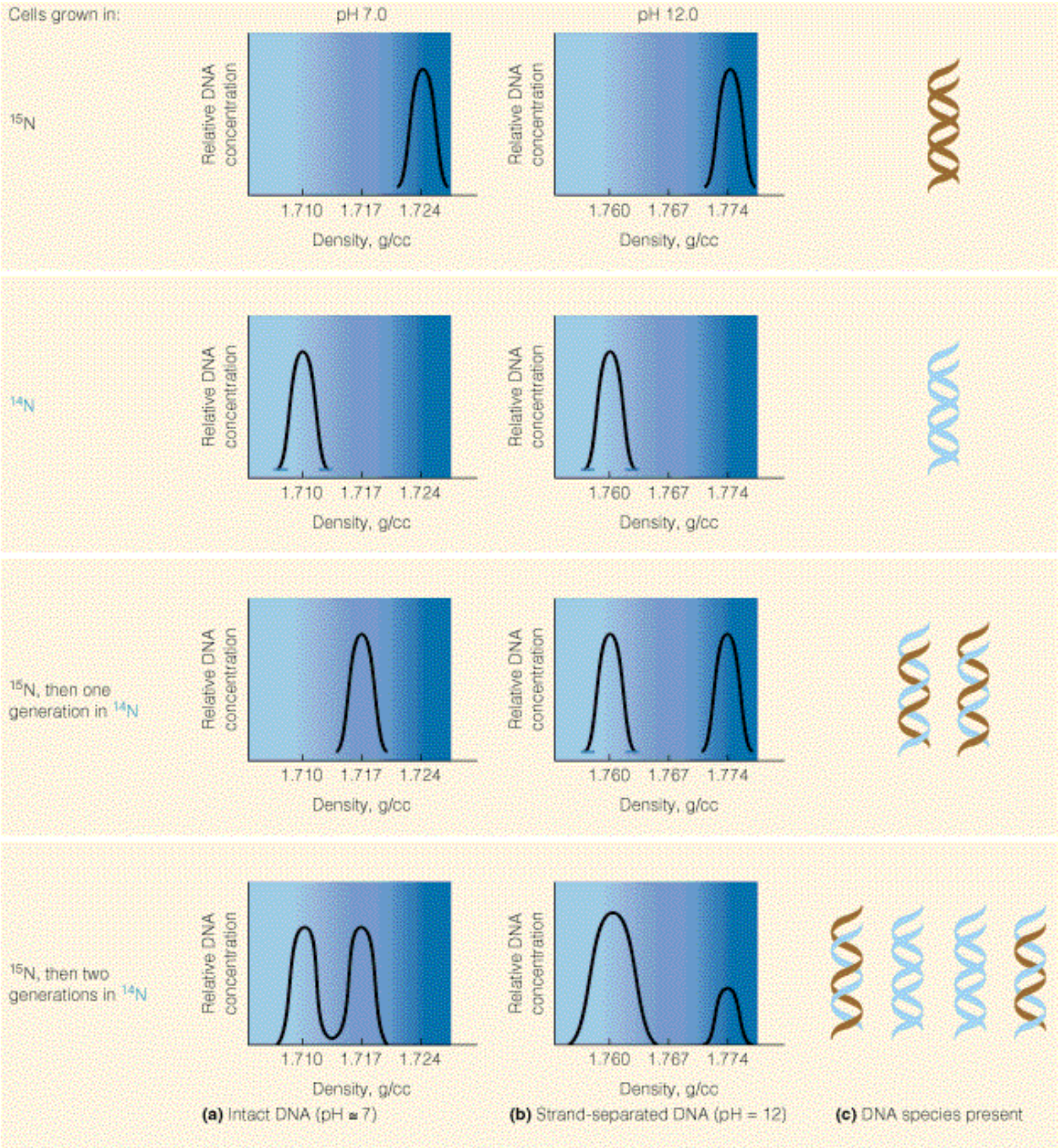

Figure 4.14: The Meselson-Stahl experiment proves DNA replicates semiconservatively.



Stability of Nucleic Acid Secondary and Tertiary Structure

The A and B forms are relatively stable for **RNA** and **DNA**, respectively, under physiological conditions. They must not be too stable, however, because processes, such as DNA replication (see [here](#)) and **transcription**, cannot occur unless the double-helix structure can be opened up. Denaturation refers to the loss of secondary (or tertiary) structure over large regions of a polynucleotide. Forces favoring denaturation of polynucleotides include

1. The electrostatic repulsion of the negative charges on the phosphate groups.
2. The higher entropy of the denatured state (the denatured form has more possible conformations than the double helix form, so the denatured form has greater randomness).

Forces stabilizing secondary structure, on the other hand, include

1. The **hydrogen bonds** between **A** and **T** and between **G** and **C** base pairs
2. The van der Waals interactions between the planar bases, which stack upon each other in the double helix structure ([Figure 4.15](#)).

The free energy change in going from a double helix structure to two individual random coils is given by

$$\Delta G = \Delta H - T\Delta S$$

1. ΔS is positive due to the increased entropy of the random coil, so the $-T\Delta S$ term makes a negative contribution to the free energy, thus favoring denaturation.
2. The electrostatic repulsion of the phosphate groups makes a negative contribution to ΔH , thus favoring denaturation, too.
3. Energy must be expended to break the hydrogen bonds between base pairs and the van der Waals interactions between the stacked bases, so these forces make a positive contribution to ΔH (and ΔG), thus favoring the double helix structure. These positive contributions exceed the negative contributions due to the phosphate groups.

Therefore, the stability of a duplex is a function of temperature. At high temperatures, denaturation is favored (the $-T\Delta S$ term dominates), but at lower temperatures duplexes are favored. The "melting temperature," T_m , corresponds to the temperature where $\Delta G = 0$. T_m is related to the ratio of $(G+C) / (A+T)$ because G-C base pairs have more hydrogen bonds (3) than A-T base pairs (2) and thus have a more positive ΔH ([Figure 4.32](#)).

Denaturation of DNA can be followed spectrophotometrically. Duplex DNA has bases packed into a helical configuration, causing them to absorb less light at 260 nm than a random coil ([Figure 4.31](#)). This phenomenon is called hypochromism. As followed in this manner, denaturation (also called strand melting) can be seen to occur over a fairly narrow temperature range. This means that the process is a cooperative transition; that is, it occurs all at once, not bit by bit or base pair by base pair. It would be very difficult for a single base to pop out of the stacked, hydrogen-bonded structure of the double helix.

See also: [Primary, Secondary, Tertiary Structure of Nucleic Acids](#), [Structure of B-DNA](#)

Concepts

DNA Replication Overview

Replication Fork

E. coli DNA Polymerases

Eukaryotic DNA Polymerases

Other Replication Proteins

Topoisomerases

Uracil-DNA N-Glycosylase

Replication Complexes

Initiation of DNA Replication

Replication of Linear Genomes

Fidelity of DNA Replication

RNA Viruses

Retrovirus Replication

Background on Transcription

Transcription is a process where information in **DNA** is assembled into **RNA** using complementarity similar to that used in making double-stranded DNA. Mechanistically, **transcription** is similar to DNA replication (see [here](#)), particularly in the use of nucleoside triphosphate substrates and the template-directed growth of nucleic acid chains in a 5' to 3' direction.

Two major differences between transcription and replication are as follows:

1. With few known exceptions, only one DNA template strand is transcribed
2. Only a small fraction of the entire genetic potential of an organism is converted to RNA in one cell.

In a differentiated eukaryotic cell, very little of the total DNA is **transcribed**. Even in single-celled organisms, in which virtually all of the DNA sequences can be **transcribed**, far fewer than half of all genes may be **transcribed** at any time.

The mechanisms used to select particular genes and template strands for **transcription** operate largely at the levels of initiation and termination of **transcription**, through the actions of proteins that contact DNA in a highly site-specific manner ([Figure 26.1](#)).

Three major types of RNA are found in cells--ribosomal RNA (**rRNA**), transfer RNA (**tRNA**), and messenger RNA (**mRNA**). They function in **ribosome** structure/function, translating the **genetic code**, and carrying the message to be translated, respectively. mRNA is a small percentage of total cellular RNA (1% to 3% in bacteria).

Bacterial genes are organized in clusters under common regulation. These clusters are called operons and are controlled by regulatory elements ([Figure 26.2](#)).

RNA polymerase is an enzyme that makes RNA using DNA as a template. RNA polymerase uses the nucleoside triphosphates, **ATP**, **GTP**, **CTP**, and **UTP** (uridine triphosphate) to make RNA. The nucleoside bases **adenine**, **guanine**, **cytosine** and **uracil** pair with the bases **thymine**, cytosine, guanine, and adenine, respectively, in DNA to make RNA. Like DNA polymerase (see [here](#)), RNA polymerases catalyze polymerization of nucleotides only in the 5' to 3' direction. Unlike DNA polymerases, however, RNA polymerases do not require a primer to initiate synthesis.

Like DNA replication (see [here](#)) and protein synthesis (see [here](#)), transcription occurs in three distinct

phases-[initiation](#), [elongation](#), and termination (see [here](#) and [here](#)). Initiation and termination signals in the DNA sequence punctuate the genetic message by directing RNA polymerase to specific genes and by specifying where transcription will start, where it will stop, and which strand will be transcribed. The signals involve instructions encoded in DNA base sequences mediated by interactions between DNA and proteins.

See also: [Eukaryotic Transcription](#) (from Chapter 28) [RNA Polymerases](#), [Initiation and Elongation](#), [Promoter Organization](#), [Factor-Independent Termination of Transcription](#), [Factor-Dependent Termination of Transcription](#) [Transcription Regulation in Phage \$\lambda\$](#) , [trp Operon Regulation](#)

INTERNET LINKS:

1. [The RNA World](#)
 2. [Transcription](#)
-

Figure 26.1: DNA-protein complex that regulates transcription.

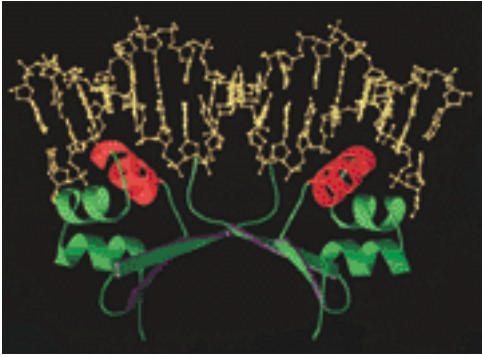

Courtesy of R. A. Albright and B. W. Matthews, Proc. Natl. Acad. Sci. USA (1998) 95:3431-3436, with permission of PNAS.

Figure 4.32: Effect of base-pair composition on the denaturation temperature of DNA.

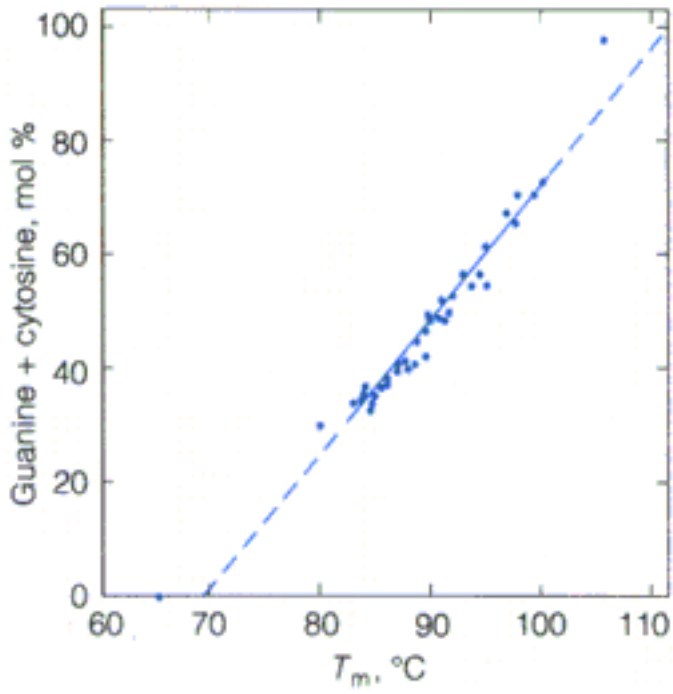

Data from J. Marmur and P. Doty, J. Mol. Biol. (1962) 5:120.

Figure 4.31: Denaturation of DNA.

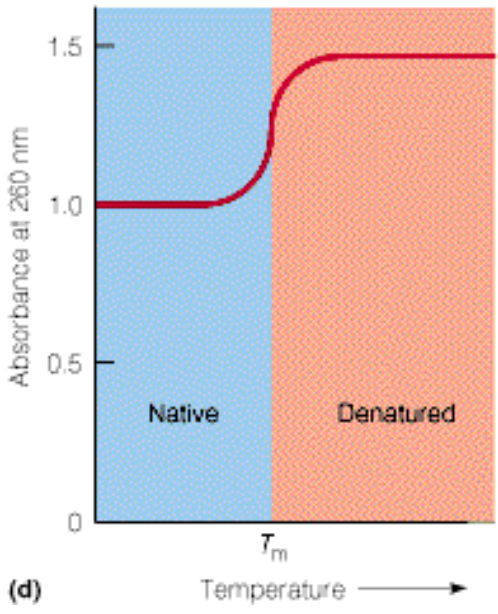
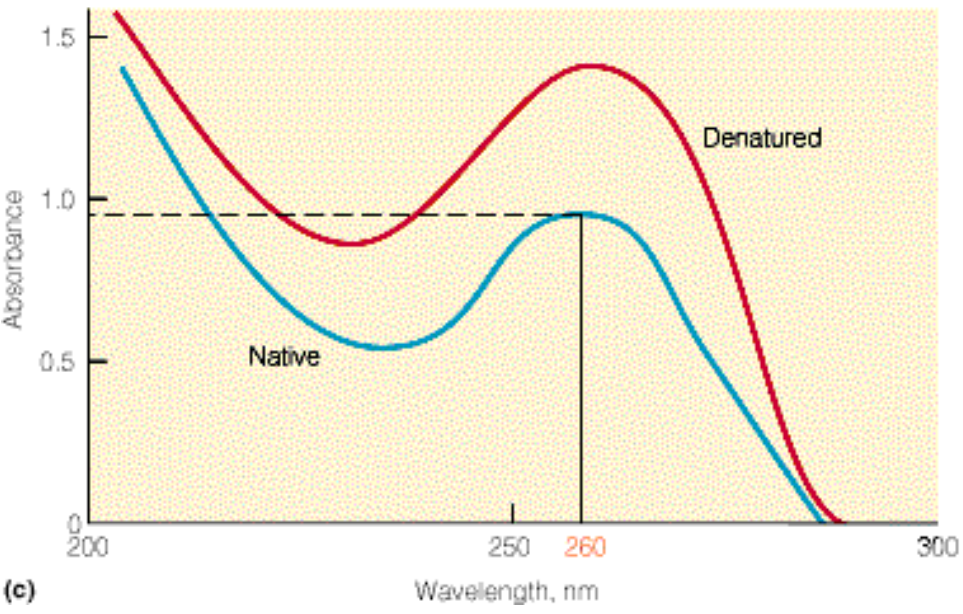
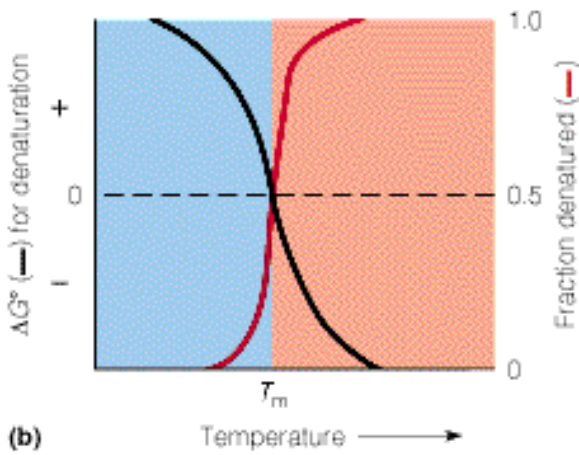
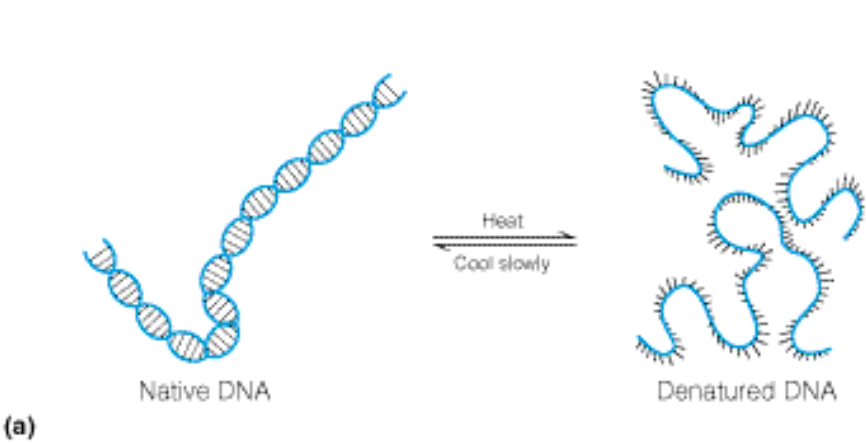

Unnumbered Figure

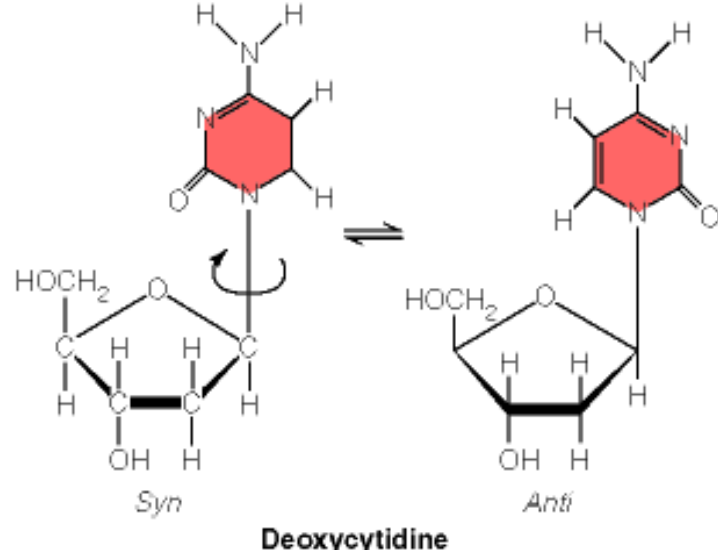
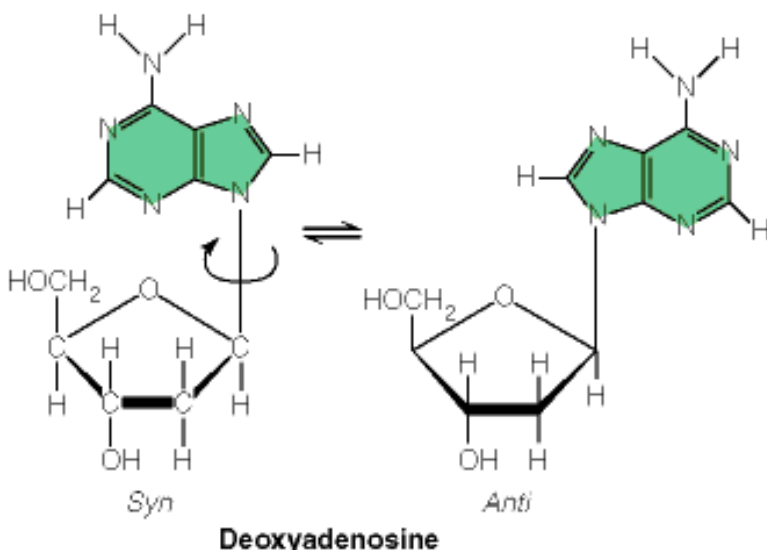

Figure 4.27: How self-complementarity dictates the tertiary structure of tRNA.

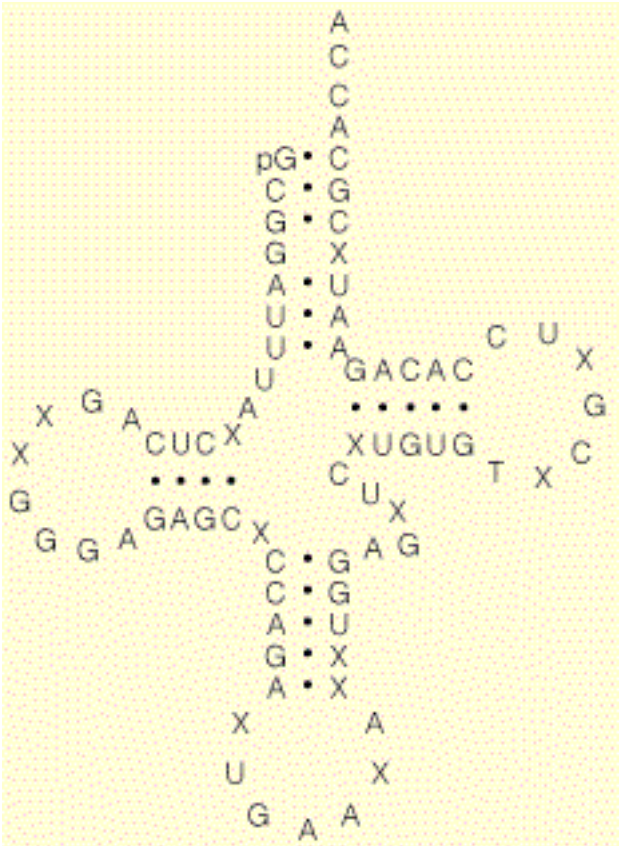
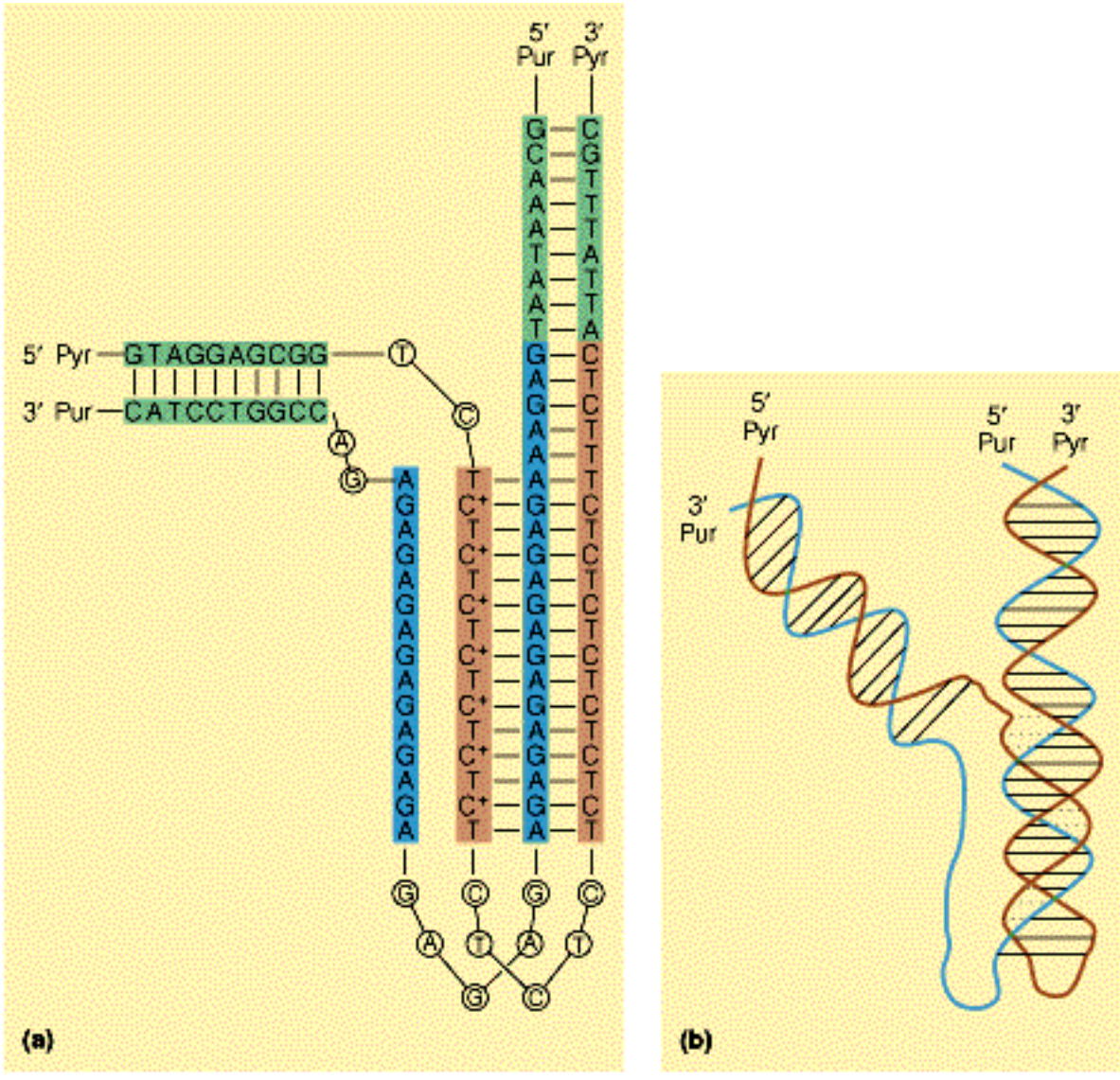
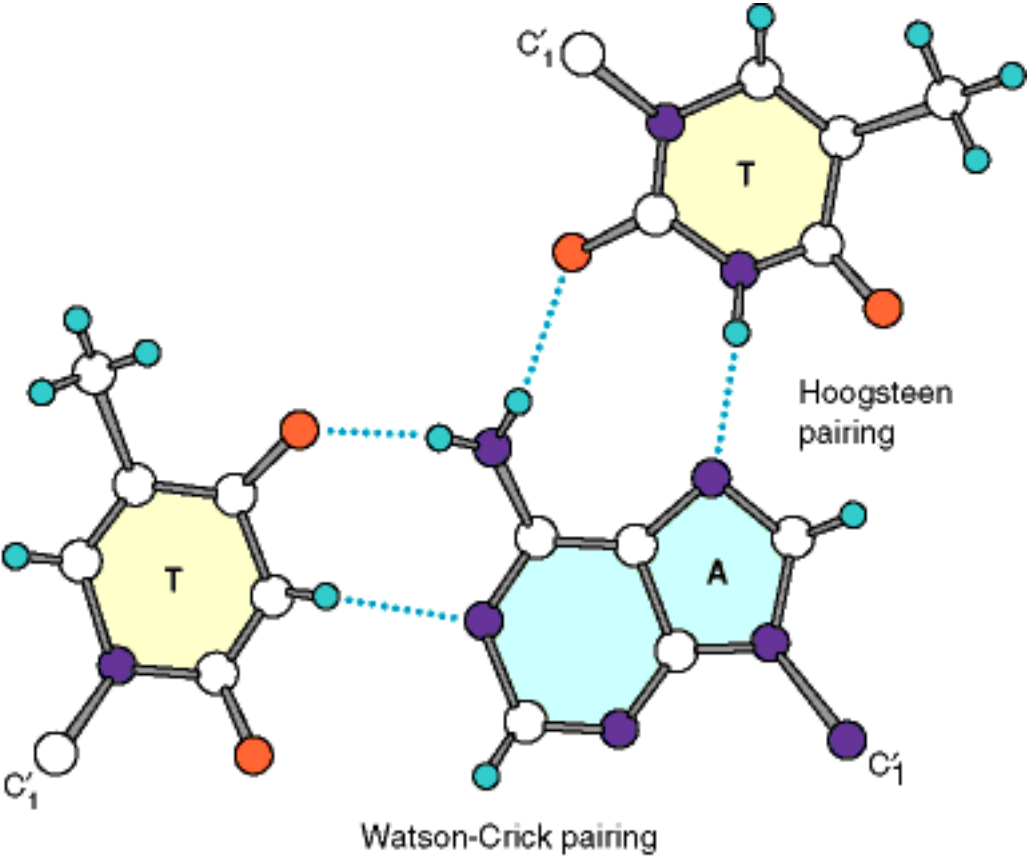

Figure 4.30: H-DNA.



Adapted from E. Palecek, Crit. Rev. Biochem. Mol. Biol., G. D. Fasman, ed. (1991) 26, 2:151-226. (Boca Raton, FL: CRC Press, 1991), with permission.

Figure 4.29: Base-pairing in one type of DNA triple helix.



Twist (T)



With respect to a DNA double helix, **twist** refers to the total number of times the two strands of the helix cross over each other, excluding writhing. **Twist** is a measure of how tightly the helix is wound.

See also: Figure 4.24, Linking Number, Supercoiling, Topoisomerases, Circular DNA and Supercoiling

INTERNET LINK: Supercoiling

Writhe (W)



With respect to a [supercoiled DNA](#) helix, **writhe** is the number of times the helix as a whole crosses over itself - that is, the number of superhelical turns that are present.

See also: [Linking Number](#), [Twist](#), [Figure 4.24](#), [Topoisomerases](#), [Circular DNA and Supercoiling](#)

INTERNET LINK: [Supercoiling](#)

Supercoiling

Supercoiling is a property of a [DNA](#) double helix in which the number of turns of the two strands around each other either exceed or are fewer than the number of turns in the most stable helical conformation. Only a helix that is circular or else fixed at both ends can support **supercoiling**. The energy stored in circular DNAs by twisting them into **supercoils** may have major effects on DNA conformation.

See also: [Figure 4.24](#), [Twist](#), [Writhe](#), [Linking Number](#), [Topoisomerases](#), [Circular DNA and Supercoiling](#)

Linking Number (L)

The **linking number** is the total number of times two strands of a DNA helix cross each other by means of either **twist** or **writhe**; this equals the number of times the two strands are interlinked. It reflects both the winding of the native DNA helix and the presence of any **supercoiling**.

See also: [Figure 4.24](#), [Topoisomerases](#), [Circular DNA and Supercoiling](#)

INTERNET LINK: [Supercoiling](#)

Nalidixic Acid

Nalidixic acid is an inhibitor of DNA replication in *E. coli*. It acts by binding to and inhibiting DNA gyrase.

See also: [Topoisomerases](#)

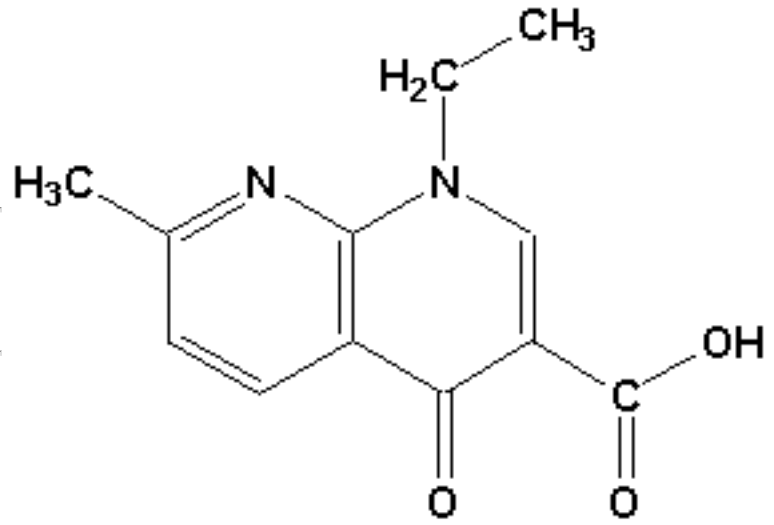

Nalidixic Acid

Figure 24.33: The types of topological interconversions catalyzed by type II topoisomerases.

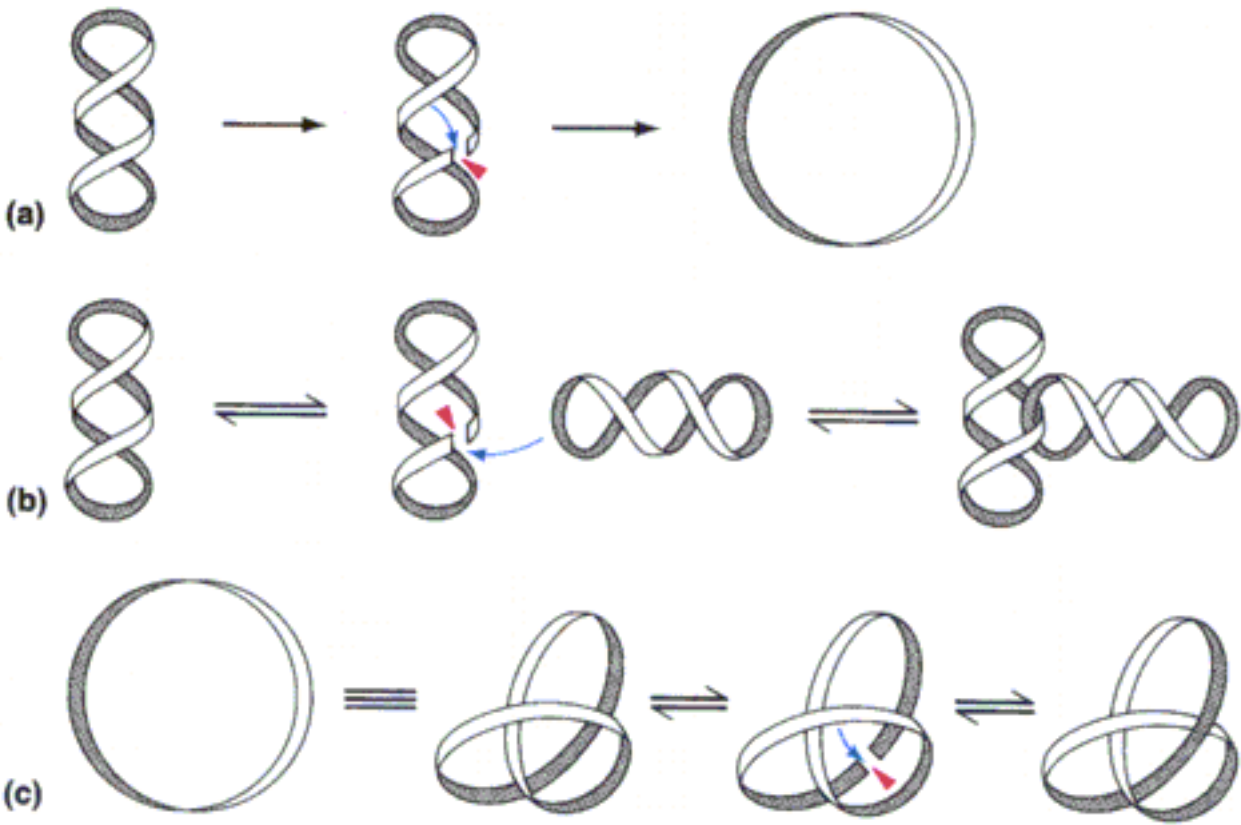
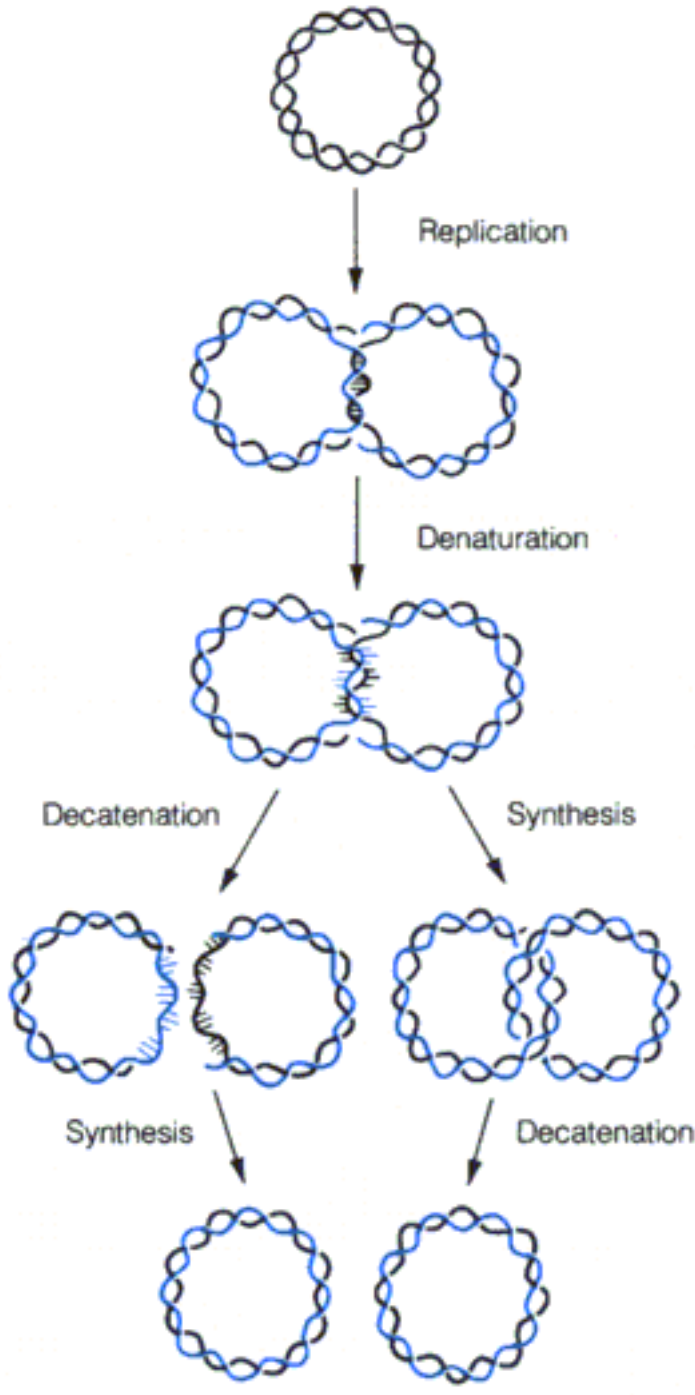
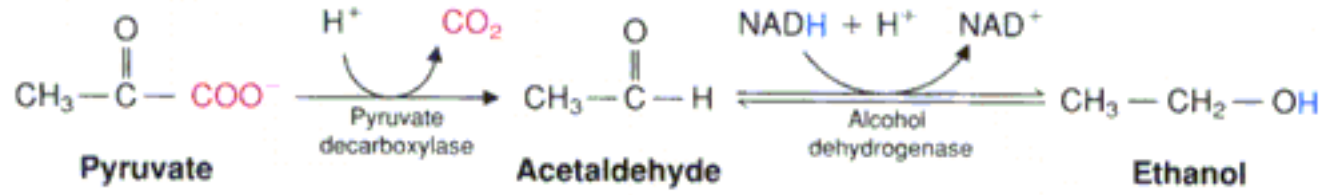

Figure 24.34: Topoisomerase action in termination of replication.



Unnumbered Item



ATP Energy Summaries

The net amounts of **ATP** generated by glycolysis depend on whether the process is occurring anaerobically or aerobically. Under aerobic conditions, the citric acid cycle, the electron transport system (ETS) and oxidative phosphorylation (OxPhos) are all occurring too. When this happens all of the carbons in glucose can ultimately be oxidized to CO₂ and the total yield is 38 molecules of **ATP** per molecule of glucose. Under anaerobic conditions, only two molecules of **ATP** are produced per molecule of glucose. If the citric acid cycle is not occurring, but ETS and OxPhos are, 8 molecules of **ATP** are produced per molecule of glucose.

See also: Oxidative Phosphorylation (from Chapter 15), Reactions/Energies of Glycolysis,

Unnumbered Item

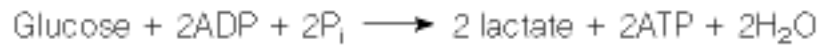

Unnumbered Item

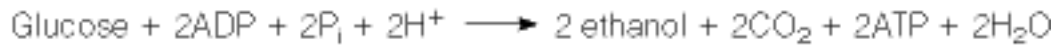

Unnumbered Item

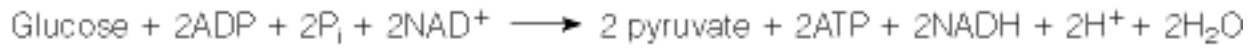

Unnumbered Item



Unnumbered Item

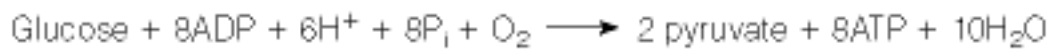
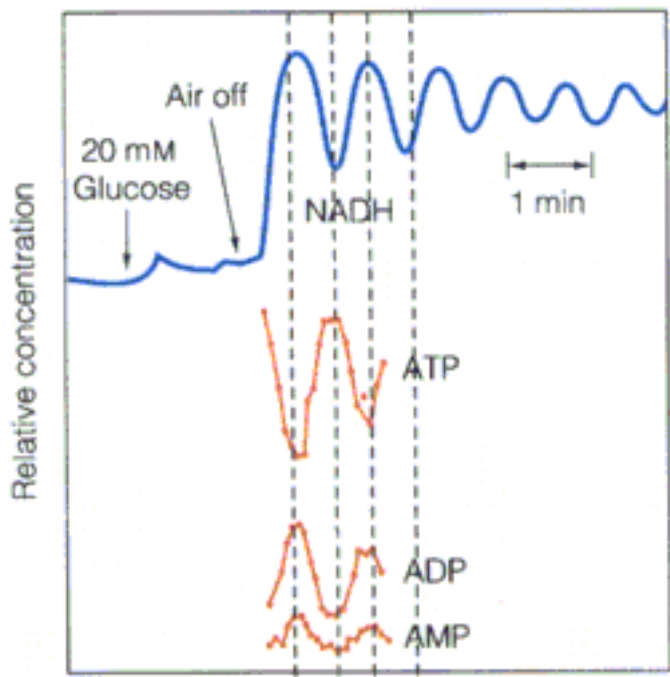
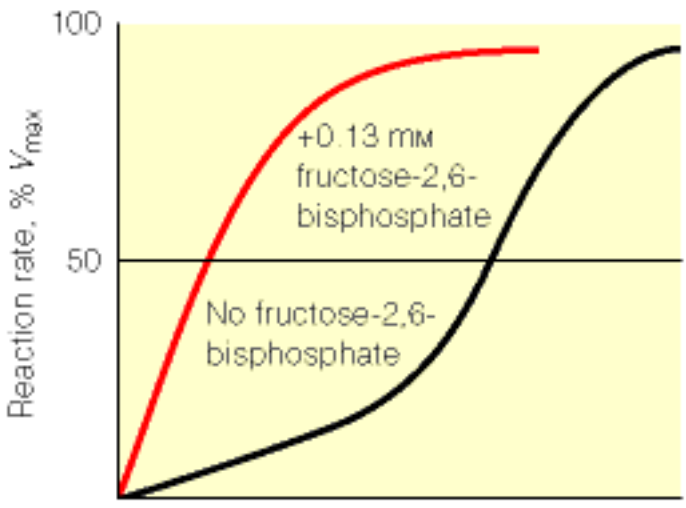

Figure 13.8: Periodic oscillations of the levels of glycolytic intermediates in yeast cells undergoing glycolysis.



Adapted with permission from A. Betz and B. Chance, Arch. Biochem. Biophys. (1964) 109:586. Copyright © 1964 Academic Press.

Figure 13.9: Allosteric control of liver phosphofructokinase.



(a) [Fructose-6-phosphate]

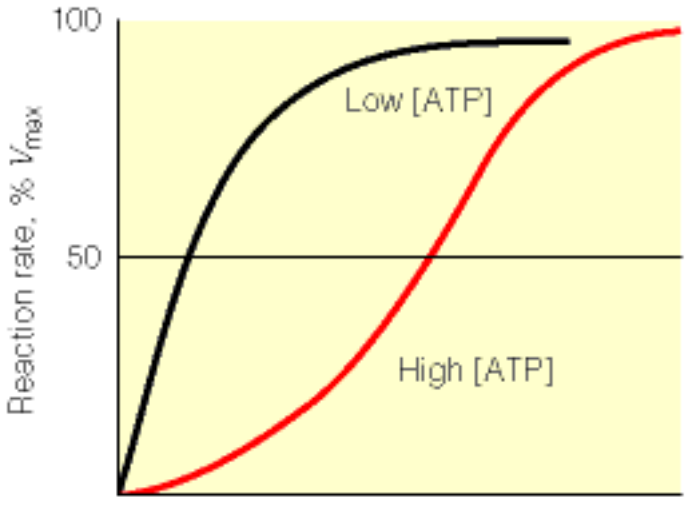

(b) [Fructose-6-phosphate]

Relationship of Glycolysis to Other Metabolic Pathways

Figure 13.1 schematically illustrates the **pathways** with which intermediates from **glycolysis** interact. These pathways include:

1. The amino acid, **alanine**, is synthesized and broken down through the **glycolytic** intermediate, **pyruvate**.
2. The **glycerol** portion of fats can be made or broken down through **DHAP**.
3. **Fatty acids** can be made or broken down using acetyl-CoA from the pyruvate formed in **glycolysis**.
4. **Acetyl-CoA** (from pyruvate) can enter the **citric acid cycle**. The citric acid cycle then produces the reduced electron carriers (**NADH** and **FADH₂**) that power electron transport and **oxidative phosphorylation**, producing substantial amounts of **ATP** in the process.
5. Glucose is produced as a breakdown product of glycogen or starch.
6. Glucose and **Glucose-6-phosphate** are intermediates in the conversion of other sugars. These sugars, in turn, are stored as polysaccharides (e.g. **glycogen**) or used to make nucleotides for making **DNA** and **RNA**.

See also: **Amino Acid Transamination** (from Chapter 21), **Fatty Acid Oxidation**, **Glycogen Breakdown**, **Other Sugar Metabolism**, **Glucose**, **Starch**,

Concepts



Mitochondrial Structure and Function

Oxidations and Energy Generation

Standard Reduction Potential

Free Energy Changes from Oxidation/Reduction

Electron Transport

Cytochromes

Difference Spectra

Inhibitors and Artificial Electron Acceptors

Shuttling Electron Carriers into the Mitochondrion

Oxidative Phosphorylation

P/O Ratio

Chemiosmotic Coupling

The F₀F₁ Complex

Integrity of Mitochondrial Membranes

Uncoupling ETS and Oxidative Phosphorylation

Respiratory Control

Oxidases and Oxygenases

Cytochrome P450

Reactive Oxygen

Oxygen Metabolism and Human Disease

Difference Spectra

For nicotinamide nucleotides, flavin nucleotides, and cytochromes, the absorption spectrum for the reduced carrier differs from that of its oxidized counterpart ([Figure 15.5](#)).

From the absorption spectrum of a mixture of these carriers, the proportions of each in the oxidized and reduced states can be ascertained. The sensitivity of the technique is increased if a **difference spectrum** is obtained ([Figure 15.8](#)). To obtain a difference spectrum, the sample cuvette contains the mixture of electron carriers under study, and the reference cuvette is filled with not a blank, but an equimolar concentration of carriers in a known state (i.e., entirely oxidized). Thus, any small absorbance changes, either positive or negative, result from reduction of a portion of the carriers in the test sample.

See also: [NAD⁺](#), [NADH](#), [FAD](#), [FADH₂](#), [Cytochromes](#)

Figure 15.8: Difference spectra of mitochondria.

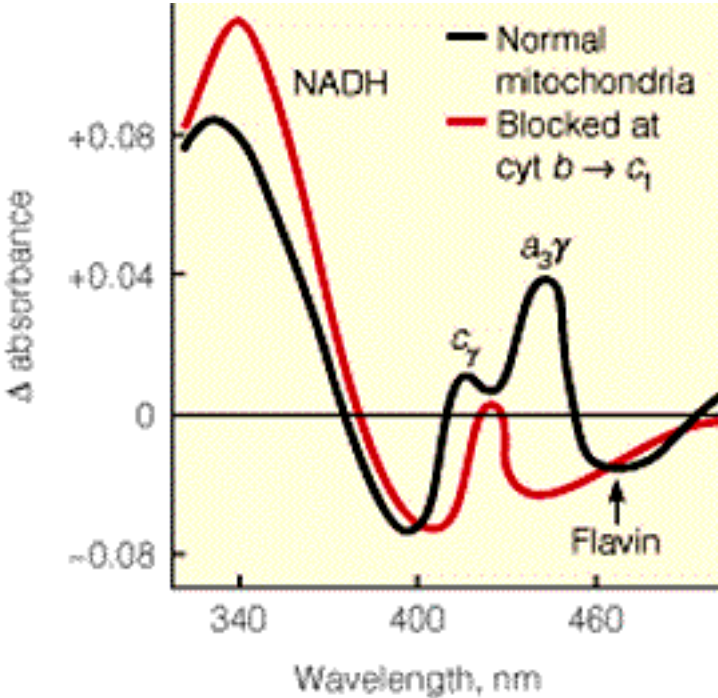

(a) Difference spectra for wavelengths below 500 nm

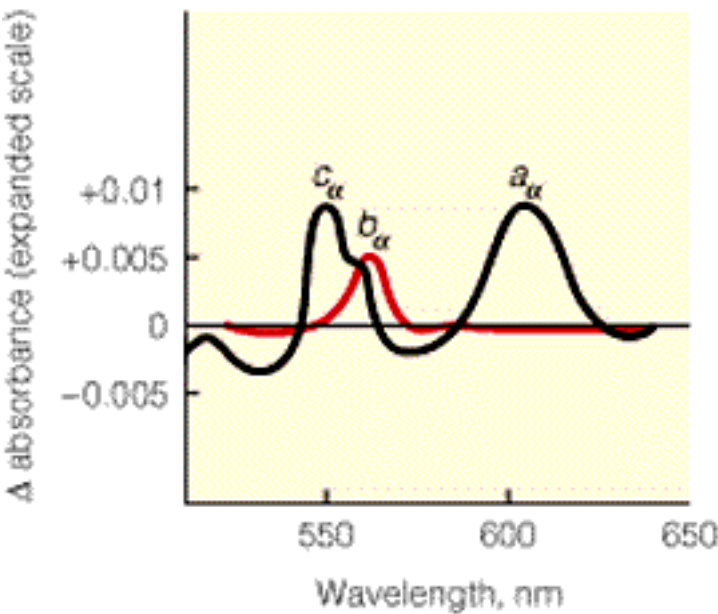

(b) Difference spectra continued with extended scale

Inhibitors and Artificial Electron Acceptors

The movement of electrons through the electron carrying proteins of the inner mitochondrial membrane is shown in [Figure 15.9](#). Also shown are **inhibitors** of electron movement at their point of action and the sites where artificial **electron acceptors** can accept electrons from the [electron transport](#) system. Specific **inhibitors** shown in [Figure 15.9](#) are rotenone, amytal, antimycin A, cyanide, azide, and carbon monoxide. The artificial electron acceptors are methylene blue, phenazine methosulfate, 2,6-indophenol, tetramethyl-p-phenylene diamine, and ferricyanide.

Addition of an **inhibitor** to electron transport creates a crossover point - a specific target of inhibition. When an overall pathway is blocked, electron carriers will be in a reduced state behind the crossover point and in an oxidized state after it. This can easily be monitored using difference spectra and is, in fact, one of the ways in which the order of action of the electron carriers in the respiratory chain was established.

Artificial **electron acceptors** have the opposite effect of **inhibitors**. That is they relieve the build-up of electrons at a specific point arising from an **inhibitor**. For example, if mitochondria were treated with both antimycin A (an **inhibitor**) and methylene blue (an artificial electron **acceptor**), Complex I would be oxidized relative to CoQ, due to release of electrons from complex I to methylene blue. CoQ would remain reduced, however, because it would be blocked from transferring its electrons to the next carrier, Complex III.

See also: [Difference Spectra](#), [Rotenone](#), [Amytal](#), [Antimycin A](#), [Cyanide](#), [Azide](#), [Carbon Monoxide](#), [Coenzyme Q](#)

Rotenone

Rotenone is a plant product from South America that is used as an insecticide. It blocks electron transport from NADH to Coenzyme Q ([Figure 15.9](#)), which is the same point that the barbiturate, amytal, works as well.

See also: [Electron Transport](#), [NADH](#), [Coenzyme Q](#), [Amytal](#)

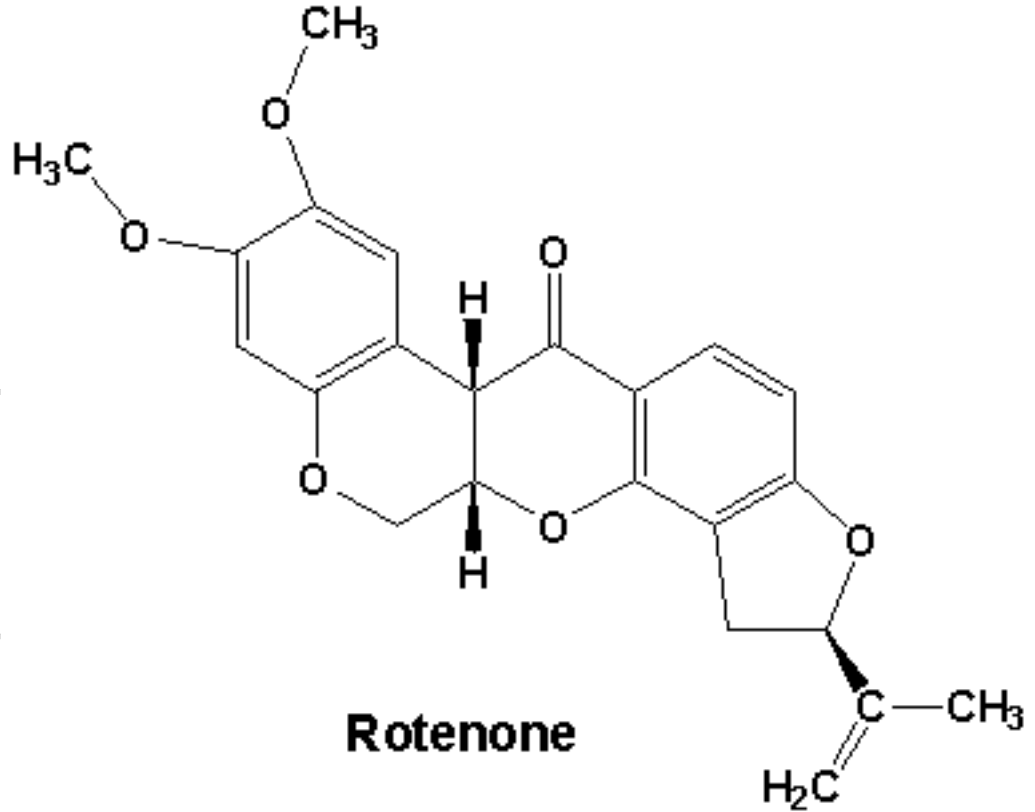

Amytal

Amytal is a barbiturate drug that blocks electron transport from NADH to coenzyme Q (Figure 15.9). **Amytal** blocks electron transport at the same point as the insecticide rotenone.

See also: NADH, Coenzyme Q, Inhibitors and Artificial Electron Acceptors

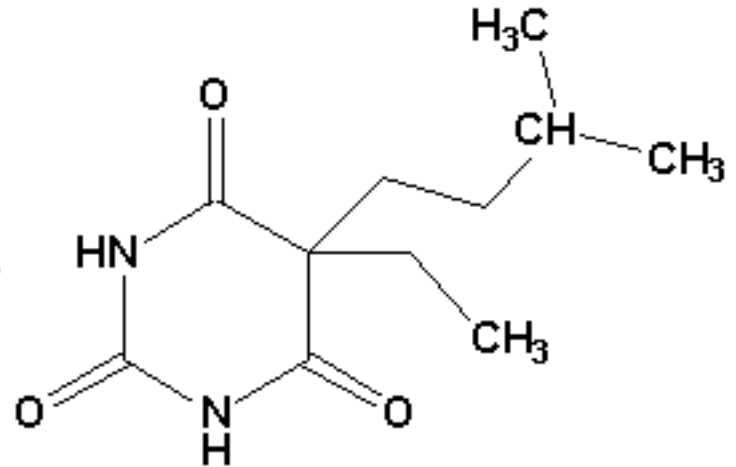

Amytal

Antimycin A



Antimycin A is an antibiotic produced by *Streptomyces* that blocks electron transport from cytochrome b to c1 (Figure 15.9).

See also: NADH, Cytochromes, Inhibitors and Artificial Electron Acceptors

Cyanide

Cyanide is a respiratory inhibitor that blocks electron transfer from cytochrome oxidase (Complex IV) to oxygen in the electron transport system ([Figure 15.9](#)).

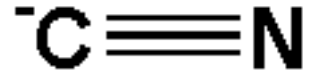

See also: [Electron Transport](#), [Cytochrome Oxidase](#), [Inhibitors and Artificial Electron Acceptors](#), [Azide](#), [Carbon Monoxide](#), [Complex IV](#)

Cyanide

Cytochrome Oxidase

Cytochrome Oxidase (also known as complex IV) is an iron and copper containing enzyme in the electron transport system. It catalyzes the final step in the electron transport process - the transfer of electrons and protons to oxygen, to form water (**Figures [15.2](#), [15.3](#), [15.10](#)**). Transfer of electrons through cytochrome oxidase can be blocked by cyanide, azide, and carbon monoxide.

See also: [Electron Transport](#), [Cyanide](#), [Azide](#), [Carbon Monoxide](#)

Azide

Azide is a respiratory inhibitor that blocks electron transfer from cytochrome oxidase (Complex IV) to oxygen in the electron transport system (Figure 15.9).

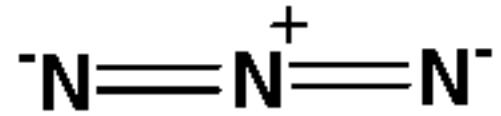

Azide

See also: Cytochrome Oxidase, Inhibitors and Artificial Electron Acceptors, Carbon Monoxide, Cyanide, Complex IV

Carbon Monoxide

Carbon Monoxide (CO) is a respiratory inhibitor that blocks electron transfer from cytochrome oxidase (Complex IV) to oxygen in the electron transport system ([Figure 15.9](#)).

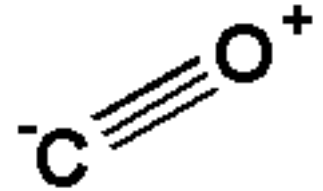

Carbon Monoxide

See also: [Electron Transport](#), [Cytochrome Oxidase](#), [Inhibitors and Artificial Electron Acceptors](#), [Azide](#), [Cyanide](#), [Complex IV](#)

P/O Ratio

The efficiency of **oxidative phosphorylation** is determined by the **P/O ratio**, which is a measure of the molecules of ATP made per pair of electrons carried through the electron transport. Experimentally, researchers isolate mitochondria from cells, then use oxygen electrodes to determine the amount of ATP synthesized per oxygen molecule reduced to water molecules in the last step of the electron transport system.

The relative amounts of ATP made per pair of electrons entering the ETS varies. Electrons entering the system at complex I from NADH have a **P/O ratio** of about 3/1. Electrons entering the system at complex II (FAD's electrons) have a **P/O ratio** of about 2/1.

With this in mind, the balanced equation for the mitochondrial oxidation of NADH is as follows:

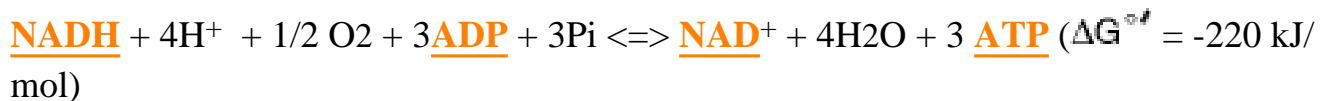

Under standard conditions, the formation of ATP from ADP and Pi requires 31 kJ/mol. Therefore, coupling the synthesis of three ATPs to the oxidation of one NADH traps 93 kJ, or about 42%, of the energy released (under standard conditions).

See also: [Chemiosmotic Coupling](#)

Figure 15.22: Experimental demonstration of respiratory control.

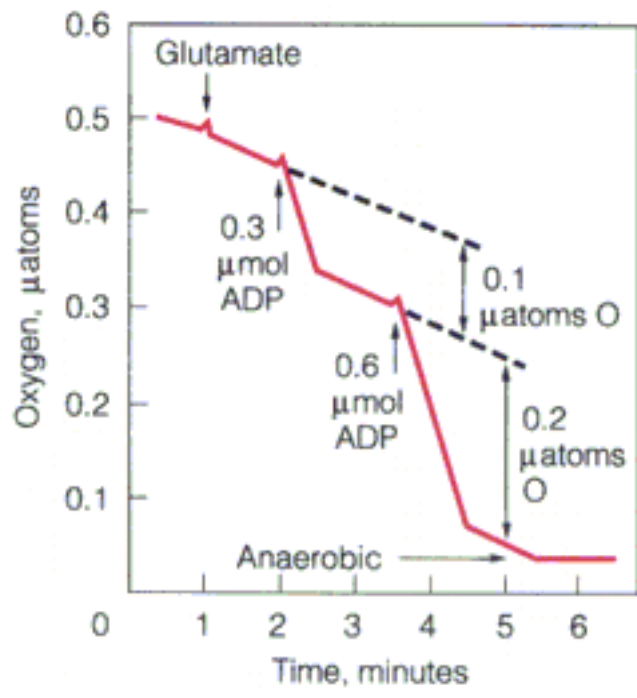

UDP-Glucose-4-Epimerase



UDP-glucose-4-epimerase (also called **UDG-galactose-4-epimerase**) catalyzes catalyzes the interconversion of **UDP-Glucose** and **UDG-Galactose**.



As shown in **Figure 13.14**, NAD^+/NADH plays an important role in the mechanism of the reaction.

See also: **Figure 11.26**, **Figure 13.13**, **Coenzymes**

Figure 13.14: Reaction pathway for UDP-galactose 4-epimerase.

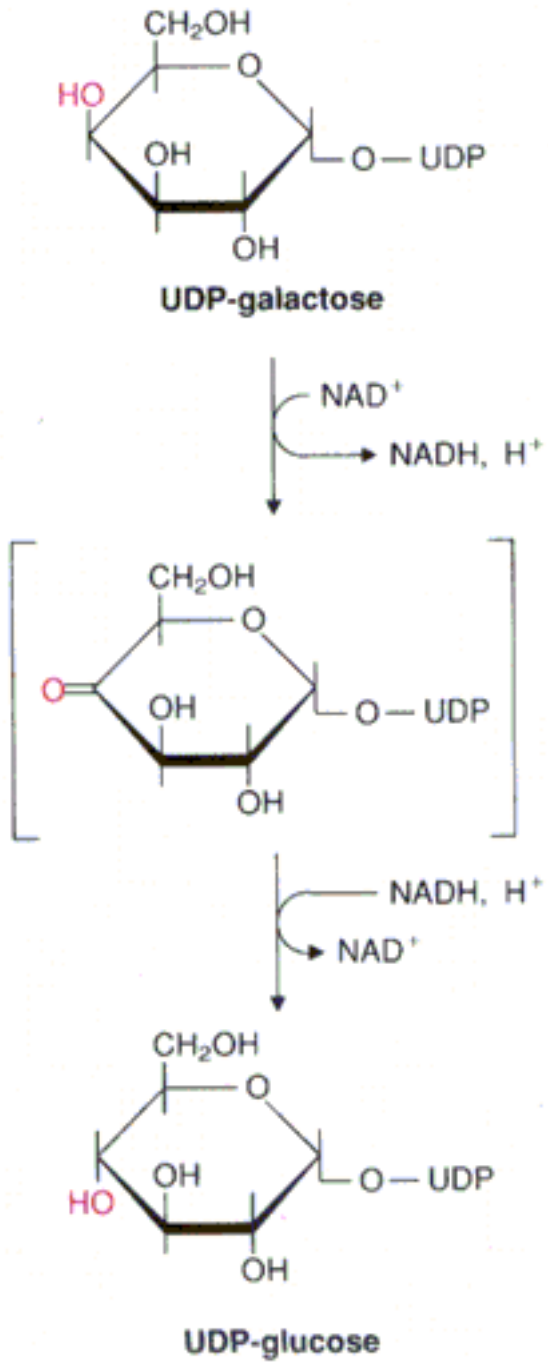

Figure 13.17: The debranching process in glycogen catabolism.

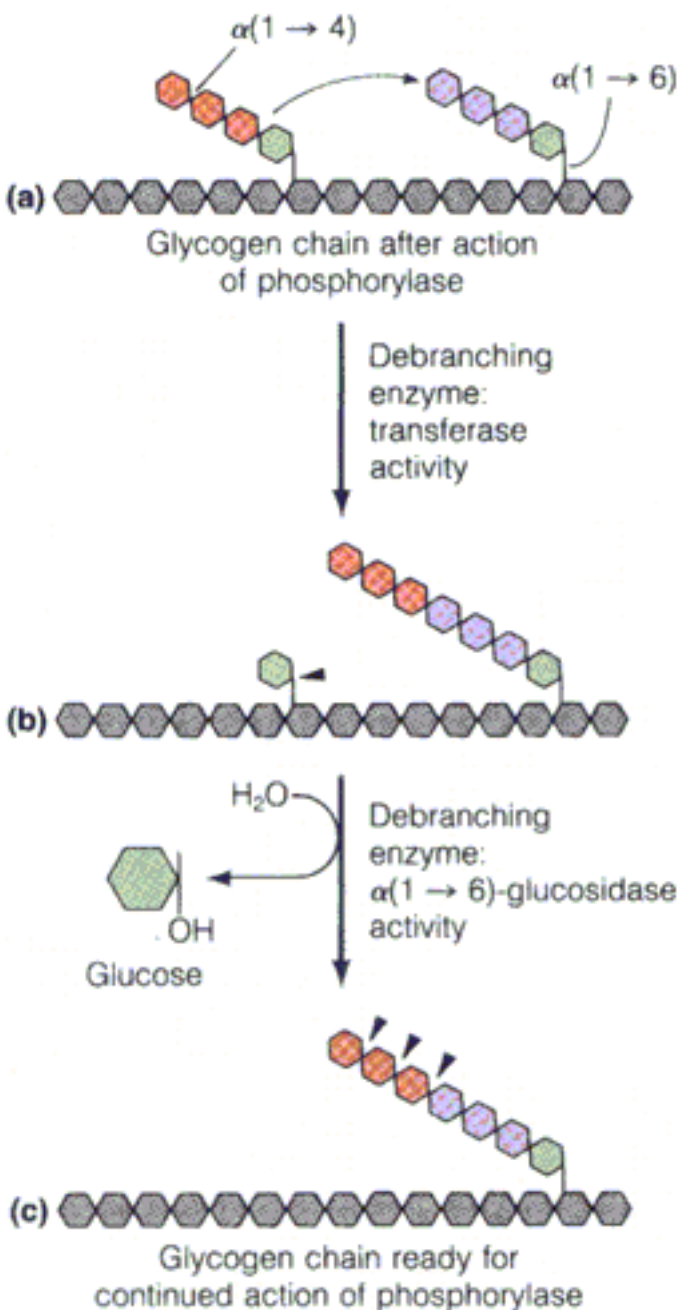

Figure 13.10: Alternative fates of glycolytic intermediates in biosynthetic pathways.

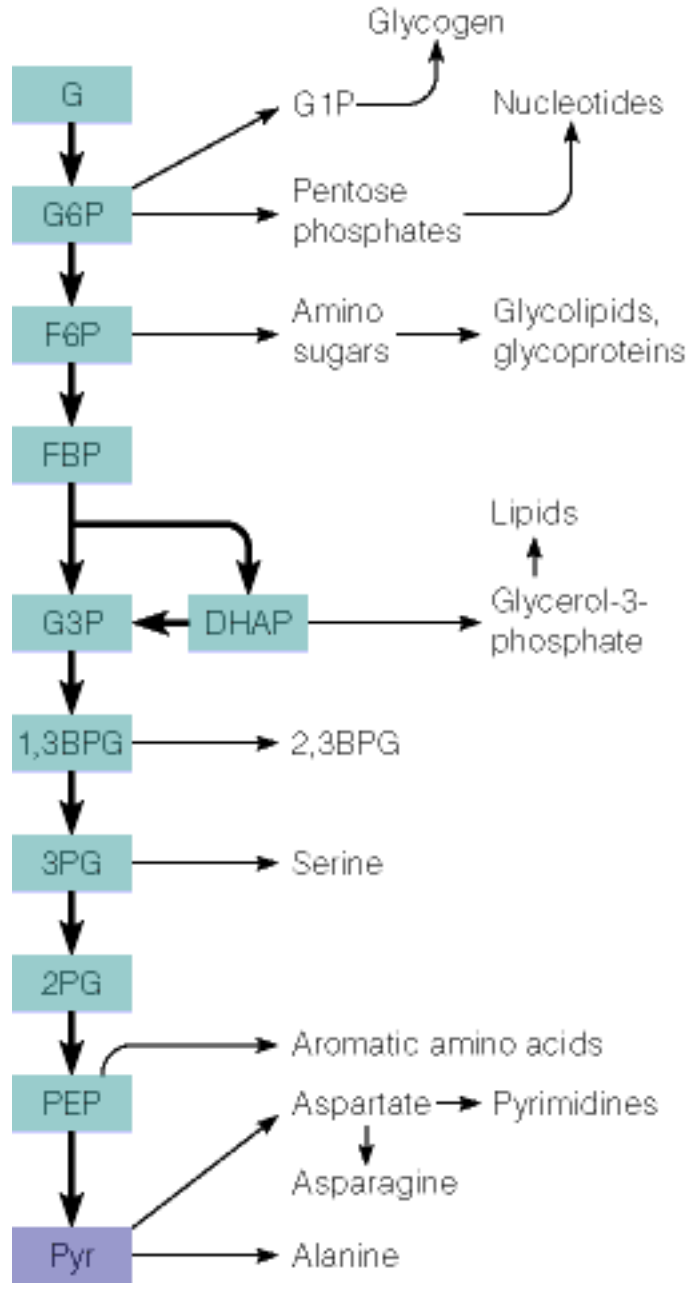
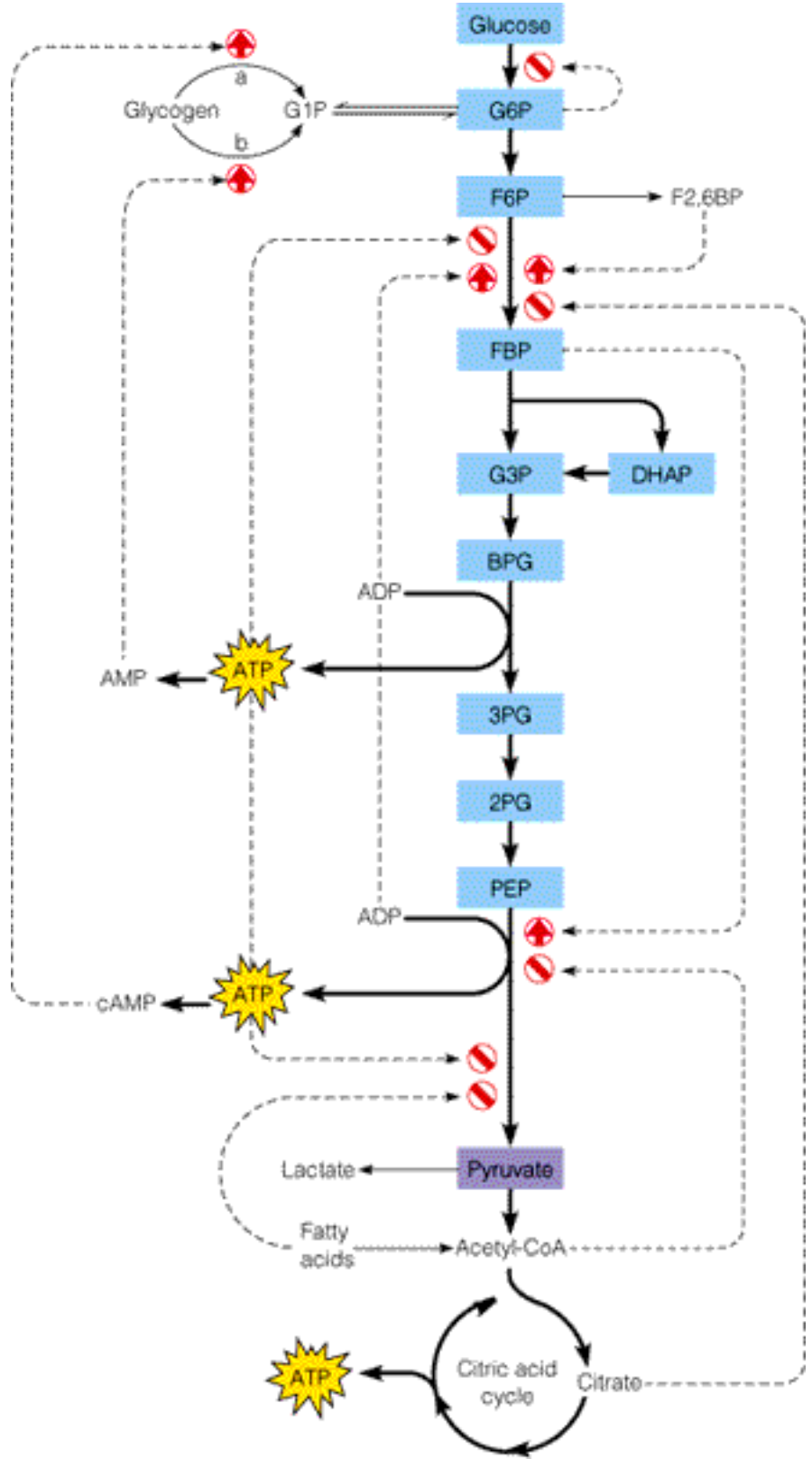

Figure 13.11: Overview of the regulation of glycolysis.



Mannose-6-Phosphate

Mannose-6-phosphate is an intermediate in metabolism of **mannose** formed in a phosphorylation reaction catalyzed by **hexokinase**. **Mannose-6-phosphate** is readily isomerized to **fructose-6-phosphate**, which participates in the glycolysis, gluconeogenesis, pentose phosphate pathway, or Calvin cycle pathways.

See also: [Figure 13.12](#), [Glycolysis](#), [Gluconeogenesis](#), [Pentose Phosphate Pathway](#), [Calvin Cycle](#), [Catabolism of Other Saccharides](#)

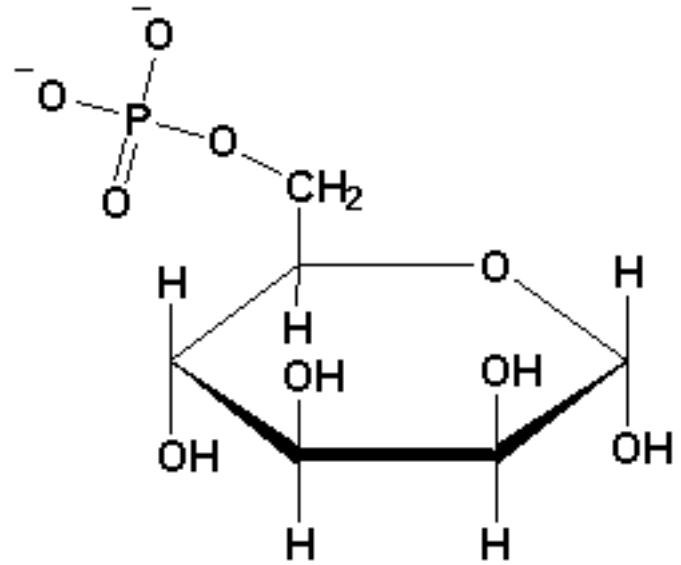

Mannose-6-Phosphate

Unnumbered Item

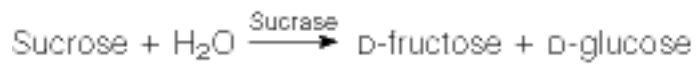
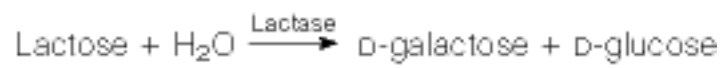
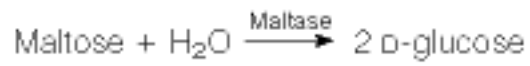

Glycerol-3-Phosphate Dehydrogenase (Gly3PDH)

Gly3PDH catalyzes the oxidation of glycerol-3-phosphate (**Gly3P**) to dihydroxyacetone phosphate (DHAP). Electrons are transferred to NAD^+ , forming NADH in the reaction. Glycerol is generated by digestion of fats. Conversion of Gly3P to DHAP by **Gly3PDH** allows all of glycerol's carbon backbone to enter the glycolysis, gluconeogenesis, or pentose phosphate pathways (via glyceraldehyde-3-phosphate).



Gly3PDH participates in the dihydroxyacetone phosphate/glycerol-3-phosphate shuttle of insect muscle ([Figure 15.11](#))

See also: [Glycolysis](#), [Gluconeogenesis](#), [Glycerol](#), [Pentose Phosphate Pathway](#)

Ethanol Metabolism and Gluconeogenesis

Ethanol strongly inhibits gluconeogenesis and can bring about hypoglycemia, a potentially dangerous decrease in blood glucose levels. **Ethanol** metabolism occurs primarily in the liver. The reaction, catalyzed by alcohol dehydrogenase, is shown as follows:



The NADH produced in this reaction shifts the equilibrium in the liver cytosol of the lactate dehydrogenase from pyruvate formation to lactate synthesis.

The NADH also favors reduction of oxaloacetate to malate in the reaction catalyzed by malate dehydrogenase, making less oxalacetate available for **gluconeogenesis**. The resulting hypoglycemia can affect the part of the brain concerned with temperature regulation and the body temperature can fall by as much as 2°C. Thus, feeding alcohol to people suffering from hypothermia is counterproductive. Metabolically speaking, glucose would be far more effective in raising body temperature.

See also: Relationship of Gluconeogenesis to Glycolysis, Gluconeogenesis, Lactate Dehydrogenase, Pyruvate, Lactate, Oxaloacetate, L-Malate.

Ferredoxin:NADP⁺ Oxidoreductase (FNR)



FNR catalyzes the transfer of electrons from ferredoxin to NADP⁺ in the last step of electron transport of photosystem II in photosynthesis.

See also: [Ferredoxin](#), [Figure 17.12b](#), [Photosystem II](#), [Photosystem Summary](#),

Unnumbered Item



Plastoquinone QB

Plastoquinones QB and QA are two molecules that participate in the electron transfer system between photosystem II (PSII) and photosystem I. The sequence of carriers is as follows: Pheophytin -> QA -> QB -> QH. **Plastoquinone QB** and QA are associated with PSII proteins. Electron transfer involving plastoquinones is shown [here](#). Reduction of a plastoquinone creates a plastoquinol.

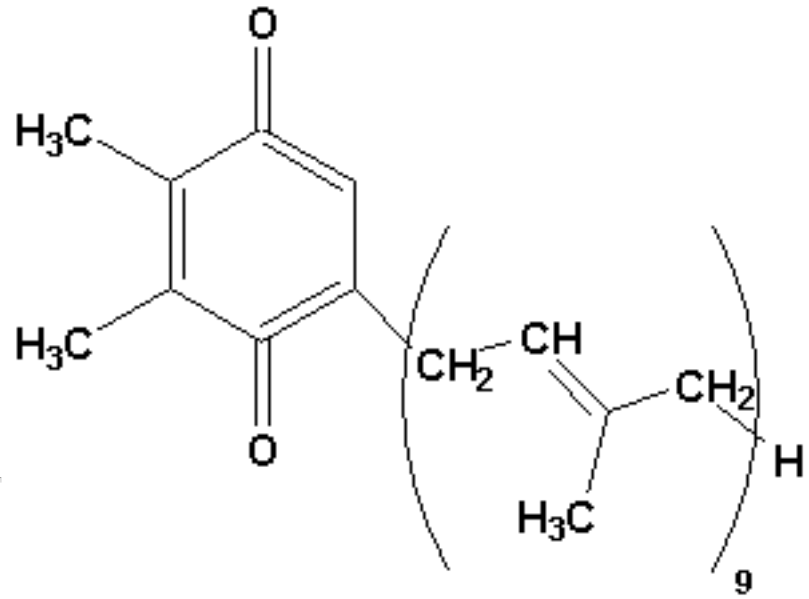

Plastoquinone QB

See also: [Plastoquinones](#), [Photosystem II](#), [Photosystem I](#), [Plastoquinone QH](#), [Pheophytin](#), [Plastoquinone QA](#)

Plastoquinone QA

Plastoquinones QA and QB are two molecules that participate in the electron transfer system between photosystem II (PSII) and photosystem I. The sequence of carriers is as follows: Pheophytin → QA → QB → QH. **Plastoquinone QA** and QB are associated with PSII proteins. Electron transfer involving plastoquinones is shown [here](#). Reduction of a plastoquinone creates a plastoquinol.

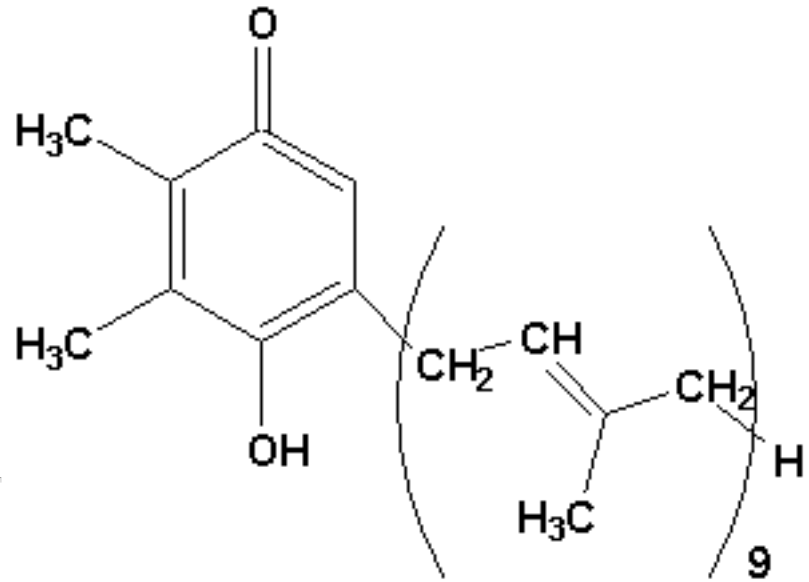

Plastoquinone QA

See also: [Plastoquinones](#), [Photosystem II](#), [Photosystem I](#), [Plastoquinone QH](#), [Pheophytin](#), [Plastoquinone QB](#)

Figure 17.13: A model for the function of the MnC cluster in PSII.

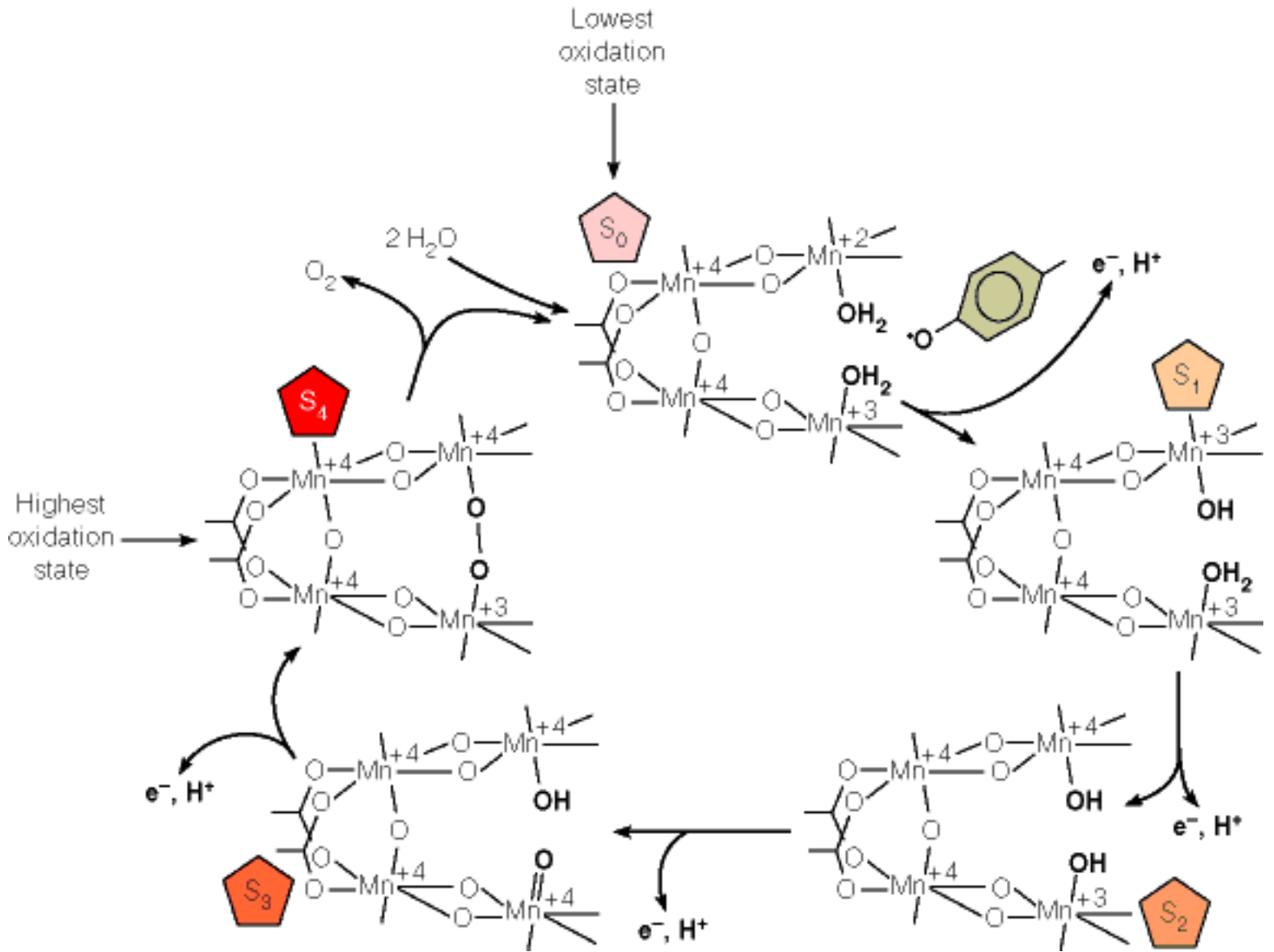

Reprinted with permission from C. W. Hoganson and G. T. Babcock, *Science* (1997) 277:1953-1955. © 1997 AAAS.

Unnumbered Item

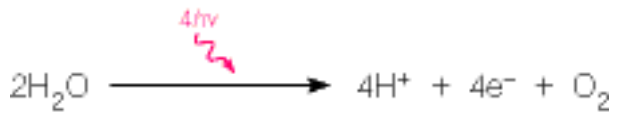

Concepts



Basic Processes of Photosynthesis

The Chloroplast

The Energy of Light

Light Absorbing Pigments

Light Gathering Structures

Photochemistry

Photosystem II

Photosystem I

Photosystem Summary

Cyclic Electron Flow

Calvin Cycle

Overall Reaction and Efficiency

Regulation of Photosynthesis

Photorespiration

The C4 Cycle

Overall Reaction and Efficiency

The [ATP](#) and [NADPH](#) needed for the dark reactions are released into the stroma by the light reactions of photosynthesis. It takes two photons for every electron that passes through photosystems I and II and it takes two electrons to produce each NADPH molecule. Thus, four photons are needed to produce each NADPH. This, in turn, means 8 photons per O₂ molecule produced by the light reactions and that 48 photons are required to produce the 12 NADPH molecules consumed per glucose made in the dark reactions. Assuming the 12 NADPH produced by non-cyclic electron flow causes enough protons to be pumped across the thylakoid membrane to make the 18 ATP necessary for making a [glucose](#), the overall reaction for photosynthesis is



If cyclic electron flow is required to produce additional ATP via cyclic photophosphorylation, then more photons will be needed.

From these assumptions, the **overall efficiency of photosynthesis** is about 35% because the 48 moles of photons of light correspond to about 8000 kJ and the energy difference between a mole of hexoses and a mole each of CO₂ and H₂O is 2870 kJ. Thus, 35% = 2870/8000.

See also: [Cyclic Electron Flow](#), [Photosystem Summary](#), [Calvin Cycle](#)

Photorespiration

Ribulose-1,5-bisphosphate carboxylase (**rubisco**) is the central enzyme of the **Calvin Cycle** because its catalyzed initial reaction is stage I, in which CO₂ is incorporated into **ribulose-1,5-bisphosphate**. This carboxylase activity occurs under conditions of low O₂ and high CO₂.

Under conditions of high O₂ and low CO₂, however, rubisco has oxygenase activity, initiating the phenomenon called **photorespiration**. When this happens, **3-phosphoglycerate** and phosphoglycolate are formed in the chloroplast from ribulose-1,5-bisphosphate. The phosphoglycolate is then dephosphorylated and transferred into the peroxisomes (cell organelles) where glycolate is oxidized to H₂O₂ (destroyed by catalase) and **glyoxylate** (**Figure 17.24**). Glyoxylate is aminated to produce **glycine**, which is transferred to the mitochondria. There, two glycines are converted into one molecule of **serine** plus one molecule each of CO₂ and NH₃. The serine ultimately is converted back to 3-phosphoglycerate.

Photorespiration results in a net loss for the cell:

Ribulose-1,5-bisphosphate is lost from the Calvin cycle;

O₂ is consumed, CO₂ is released;

Only a part of the carbon is returned to the chloroplast;

ATP is expended without apparent benefit.

Plant cells probably undergo **photorespiration** for a reason, however. Under conditions of high illumination, CO₂ levels around a plant may fall. Under these conditions, reactive oxygen species, such as superoxide, could be produced, causing damage to the plant. **Photorespiration**'s function may be to protect against reactive oxygen species under these conditions by consuming oxygen and releasing CO₂.

See also: **The C4 Cycle**, **Reactive Oxygen** (from Chapter 15), **Oxidases and Oxygenases** (from Chapter 15)

Glyoxylate

Glyoxylate is a two carbon compound generated in the glyoxylate cycle by action of the enzyme isocitrate lyase on isocitrate (the other product of the reaction is succinate). **Glyoxylate** is combined with acetyl-CoA to form malate by the enzyme malate synthase.

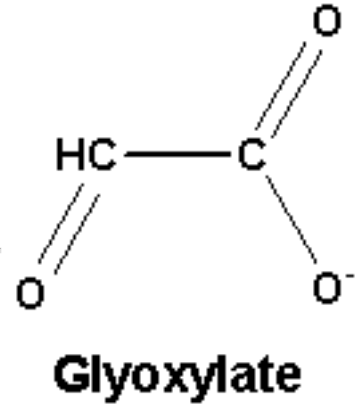

See also: [Isocitrate Lyase](#), [Glyoxylate Cycle](#), [Glyoxylate Cycle Intermediates](#), [Figure 14.20](#), [Malate Synthase](#)

INTERNET LINK: [Glyoxylate Cycle Metabolism](#)

Figure 14.20: Reactions of the glyoxylate cycle.

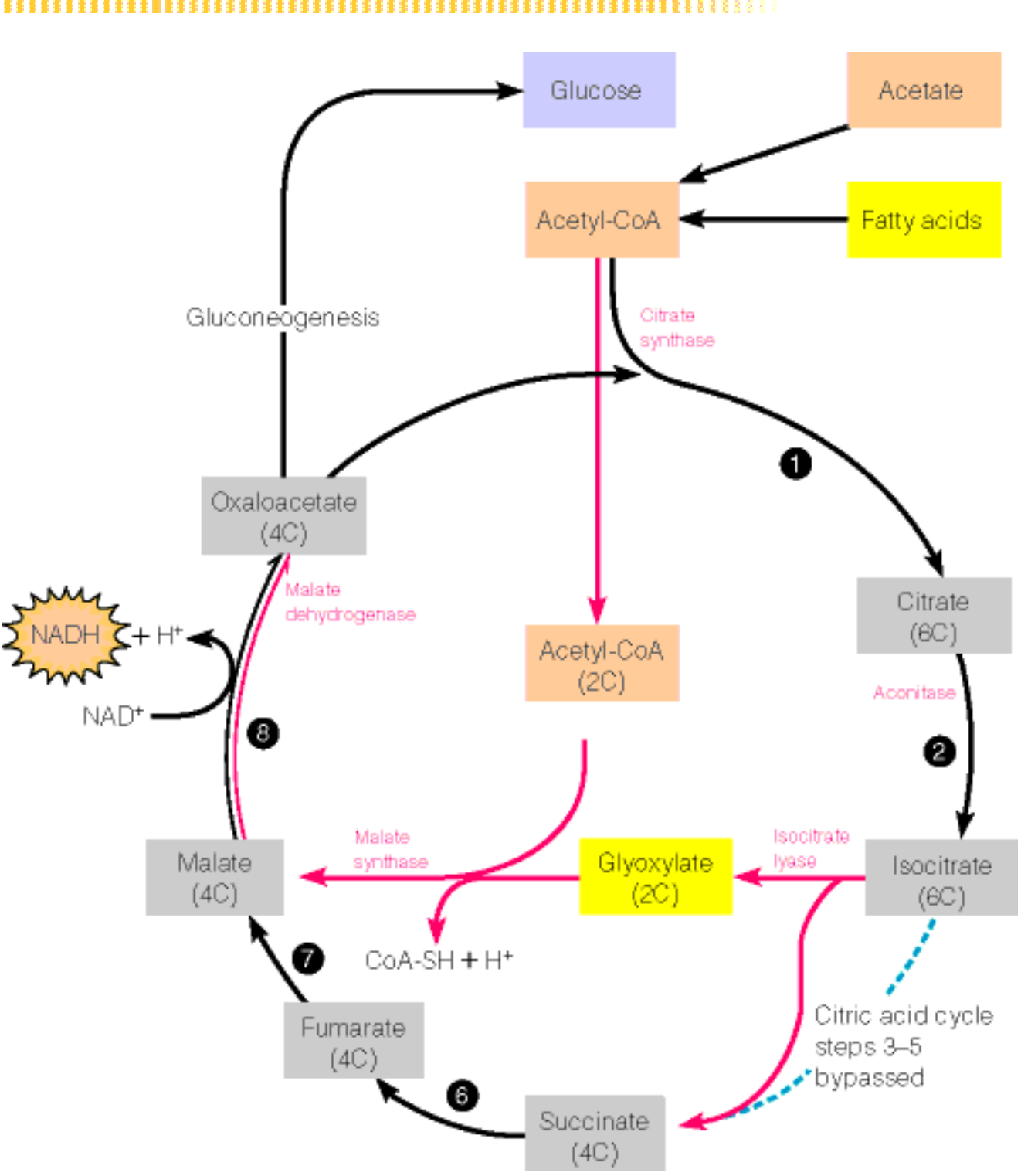

Malate Synthase

Malate synthase is an enzyme of the [glyoxylate cycle](#) that catalyzes the reaction below:

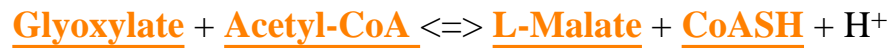

See also: [Glyoxylate Cycle Enzymes](#), [Figure 14.20](#)

INTERNET LINK: [Glyoxylate and Dicarboxylate Metabolism](#)

Enzymes of the Glyoxylate Cycle

[Citrate Synthase](#)

[Aconitase](#)

[Isocitrate Lyase](#)

[Malate Synthase](#)

[Succinate Dehydrogenase](#)

[Fumarate Hydratase](#) (Fumarase)

[Malate Dehydrogenase](#)

See also: [Glyoxylate Cycle Intermediates](#), [Glyoxylate Cycle Reactions](#), [Figure 14.20](#), [Citric Acid Cycle Pathway](#)

INTERNET LINK: [Glyoxylate Cycle Metabolism](#)

Glyoxylate Cycle Intermediates

Oxaloacetate + Acetyl-CoA

Citrate

Isocitrate

Glyoxylate

Succinate

Fumarate

Malate

See also: [Glyoxylate Cycle Enzymes](#), [Glyoxylate Cycle Reactions](#), [Figure 14.20](#)

INTERNET LINK: [Glyoxylate Cycle Metabolism](#)

Figure 17.24: Photorespiration.

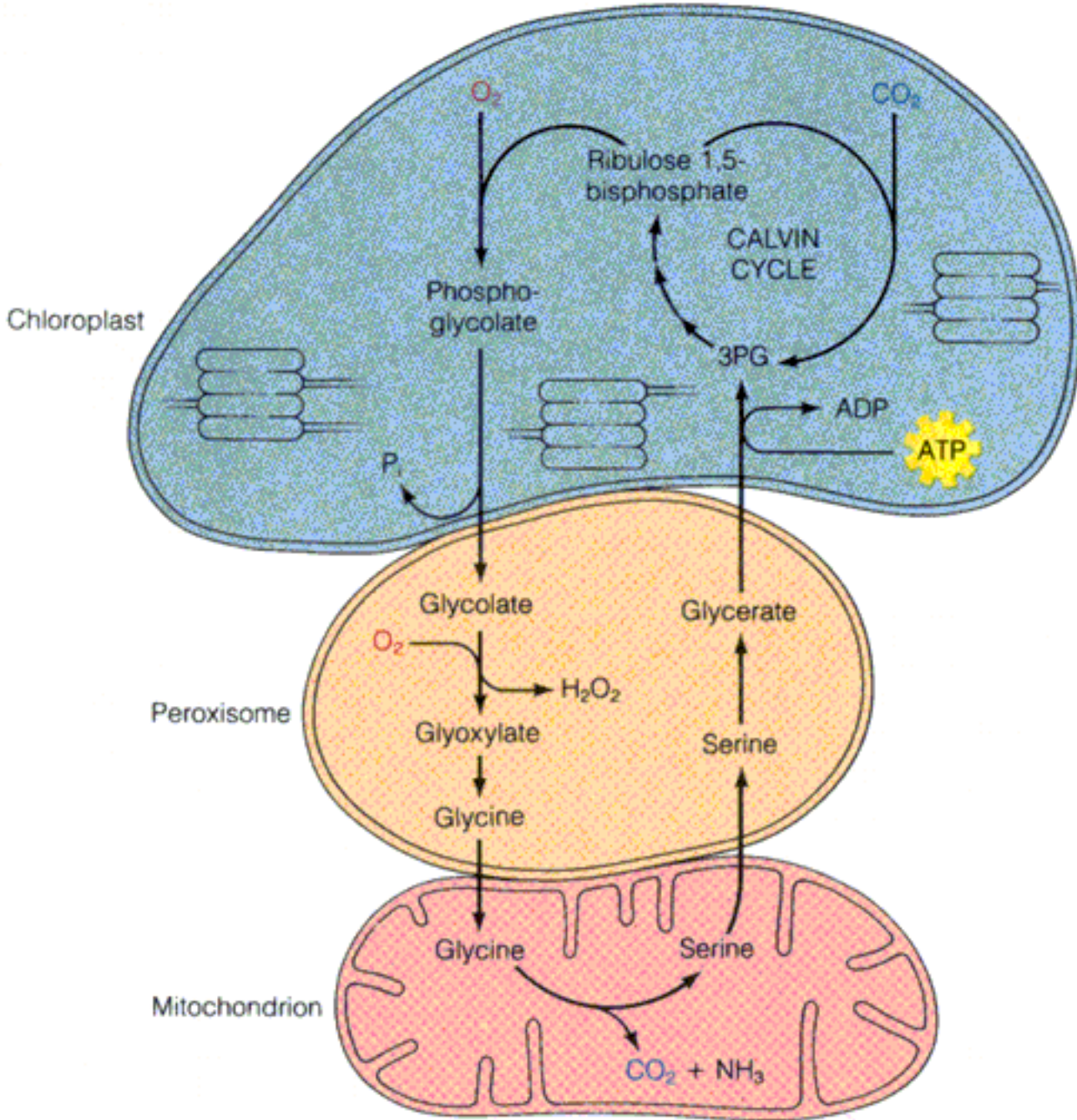

The C4 Cycle

Photorespiration is an inefficient process occurring in plants under conditions where CO₂ levels are low. Certain plants called **C4 plants** have evolved an additional photosynthetic pathway that helps conserve CO₂ released by photorespiration. This pathway is called the **C4 cycle** because it incorporates CO₂ into an intermediate with four carbons ([oxaloacetate](#)). By contrast, the [Calvin cycle](#) is sometimes called the C₃ cycle because the reaction of CO₂ with ribulose-1,5-bisphosphate yields two molecules of 3-phosphoglycerate, a three - carbon compound.

The **C4 cycle** is found in important crop species, such as maize and sugarcane, and is important in tropical plants, which are exposed to intense sunlight and high temperatures. Photorespiration is most active under these conditions.

C4 plants concentrate their Calvin cycle photosynthesis in specialized [bundle sheath cells](#), which lie below a layer of mesophyll cells ([Figure 17.25](#)). The mesophyll cells, which are most directly exposed to external CO₂, contain the enzymes of the **C4 cycle**. See [Figure 17.26](#) for the reactions of the **C4 cycle**. The key reaction, which is the capture of CO₂ into oxaloacetate, is catalyzed by the enzyme [phosphoenolpyruvate carboxylase](#) and occurs in the mesophyll cells.

Unlike ribulose bisphosphate carboxylase ([rubisco](#)) from the Calvin cycle, phosphoenolpyruvate carboxylase has no oxygenase activity. As a result, capturing CO₂ into oxaloacetate serves as a mechanism for delivering CO₂ to the Calvin cycle process in the bundle sheath cells, not for initiating photorespiration. In this way, high levels of CO₂ can be maintained in the bundle sheath cells, favoring CO₂ fixation rather than photorespiration. Even if photorespiration does occur, CO₂ released in that process may be readily returned to the Calvin cycle by the C₄ pathway, instead of being lost.

Note that the **C4 cycle** costs 2 additional ATPs for every CO₂ fixed. This price may seem steep, but it appears to be worth paying under circumstances when photorespiration would dominate.

See also: [Photorespiration](#)

INTERNET LINK: [Carbon Fixation in C4 Plants](#)

Bundle Sheath Cells

Bundle sheath cells are specialized cells found in C₄ plants that lie below a layer of mesophyll cells ([Figure 17.25](#)). The **bundle sheath cells** are the sites within C₄ plants where the [Calvin cycle enzymes](#) are located. By being beneath the mesophyll cells, the **bundle sheath cells** have a lower oxygen concentration and a steady supply of CO₂ from the mesophyll cells ([Figure 17.26](#)). The combination of these factors helps reduce the amount of wasteful oxygenase activity of [rubisco](#), known as photorespiration.

See also: [The C₄ Cycle](#), [Photorespiration](#),

Figure 17.25: Structural differences between leaves of C₃ and C₄ plants.

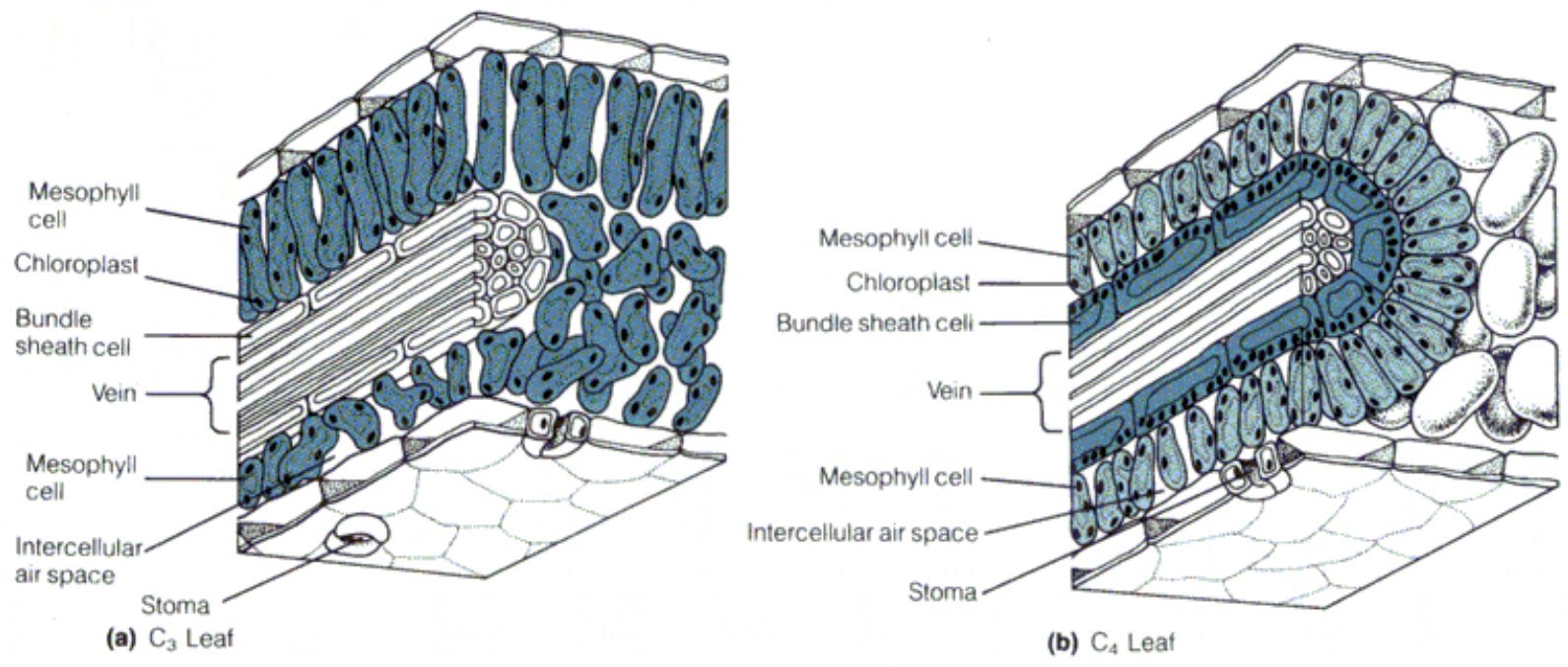

From N. A. Campbell, Biology, 2nd ed. (Redwood City, Calif.: Benjamin/Cummings, 1990). © 1990 Benjamin/Cummings Publishing Company.

Figure 17.26: Reactions of the C4 cycle.

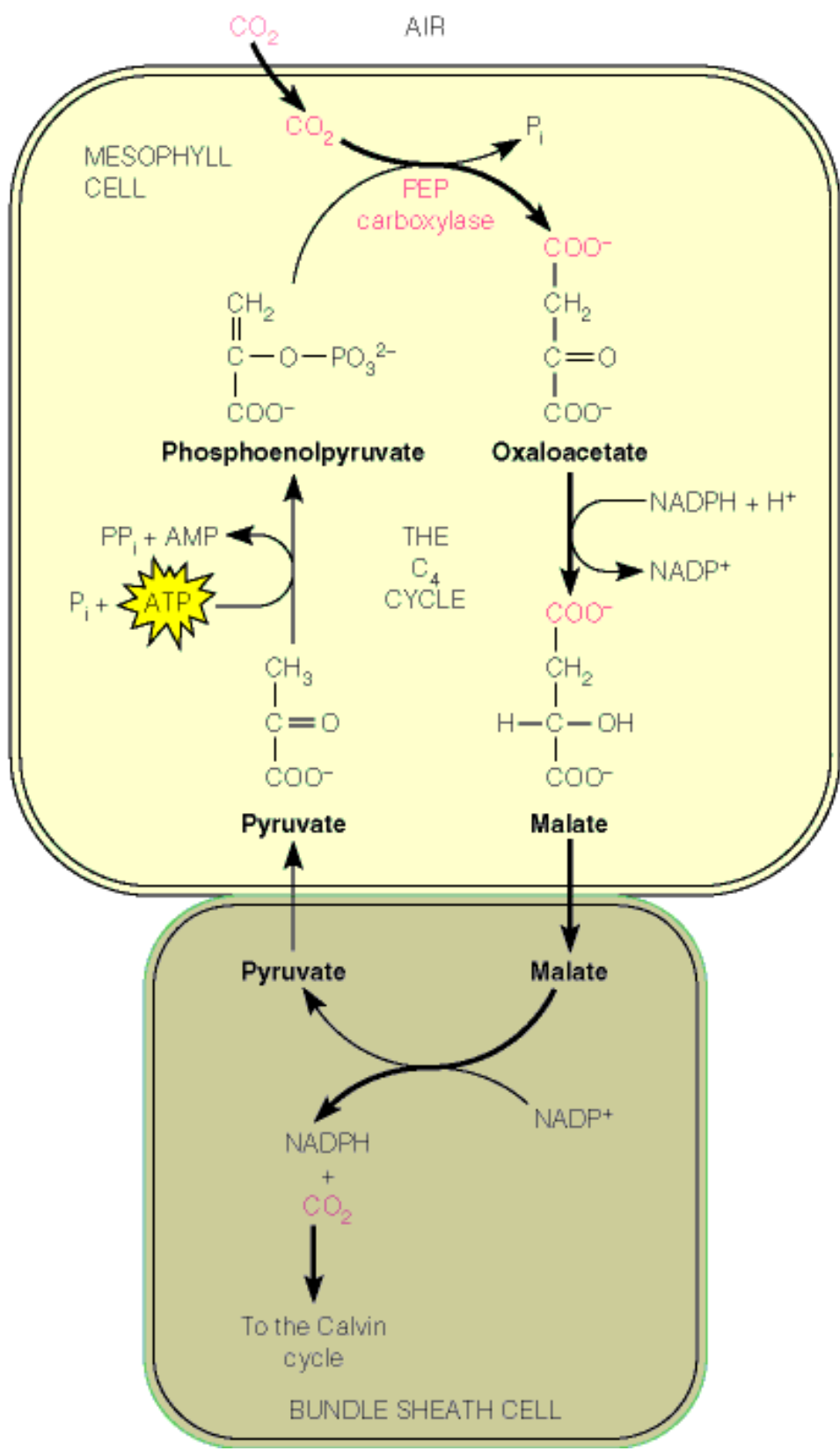
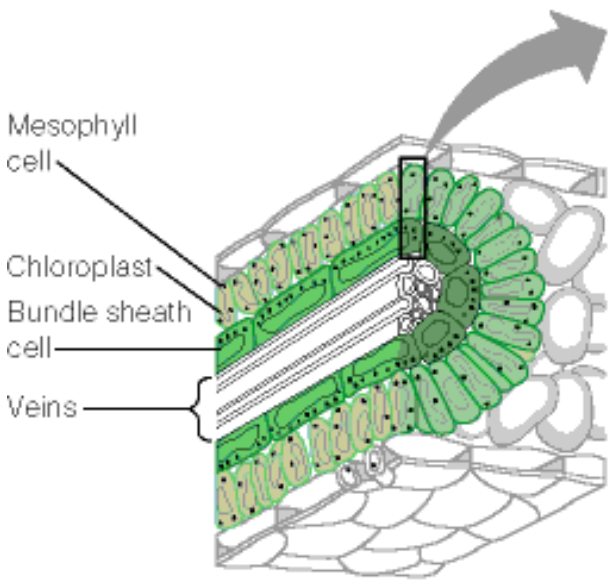

PEP Carboxylase

PEP carboxylase catalyzes conversion of phosphoenolpyruvate (PEP) to Oxaloacetate.



The reaction, which occurs in C4 plants and bacteria, uses the high energy phosphate of PEP to drive the incorporation of a carboxyl group in order to form oxaloacetate. In C4 plants, **PEP carboxylase** is located in the mesophyll cells on the external surfaces of the plant. Incorporation of CO₂ in this manner helps to shuttle CO₂ to the bundle sheath cells, where the Calvin cycle enzymes are concentrated. It also helps to avoid the wasteful photorespiration cycle due to the oxygenase activity of the CO₂ fixing enzyme, rubisco.

See also: [C4 Cycle](#), [Bundle Sheath Cells](#), [Calvin Cycle](#), [Photorespiration](#), [Rubisco](#)

Figure 20.20: The intramolecular rearrangement catalyzed by methylmalonyl-CoA mutase.

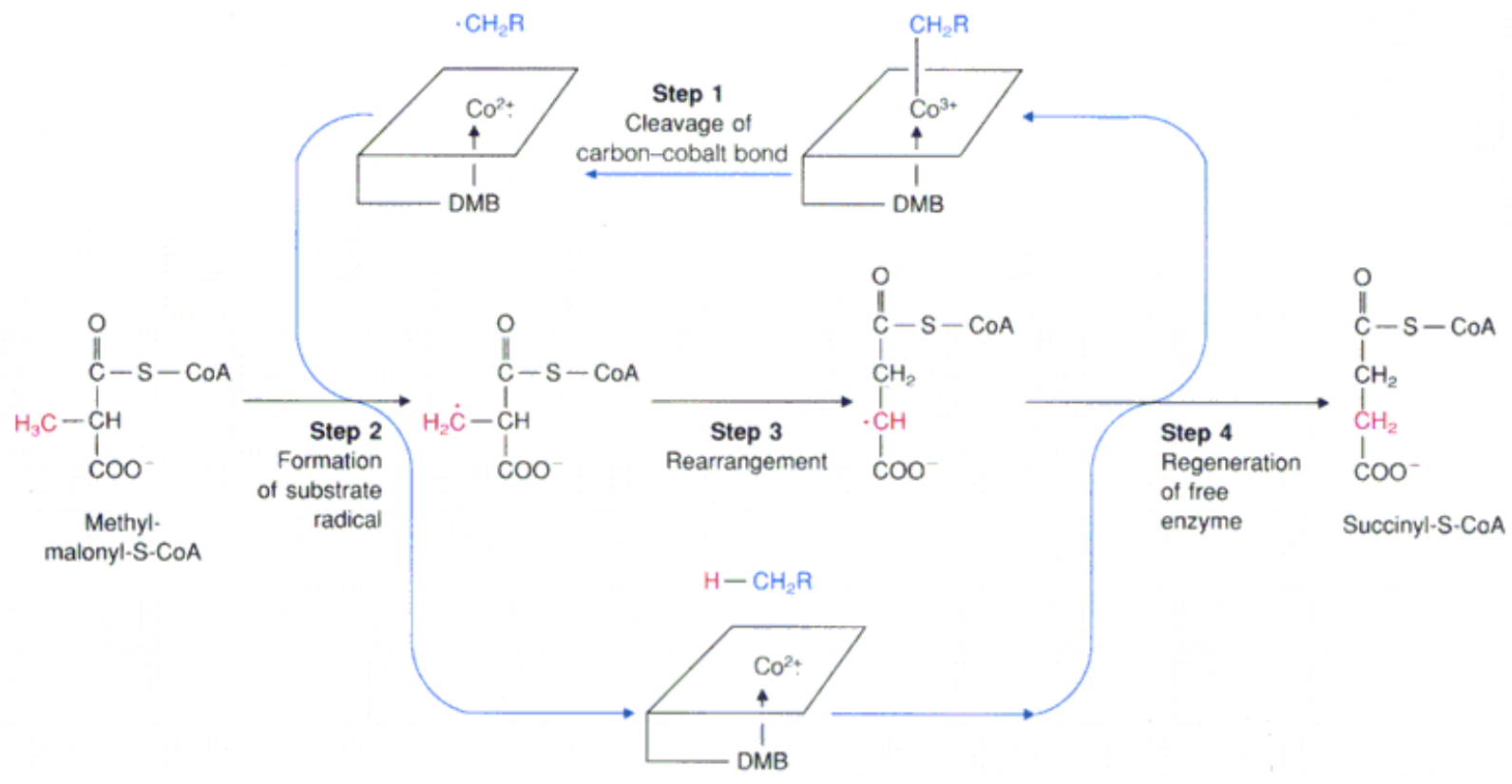

Unnumbered Item

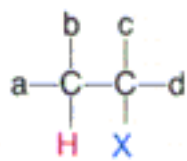
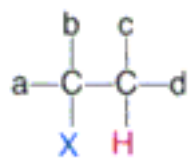
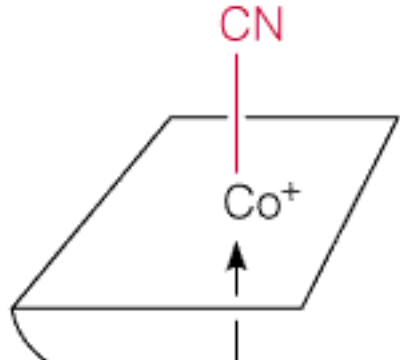
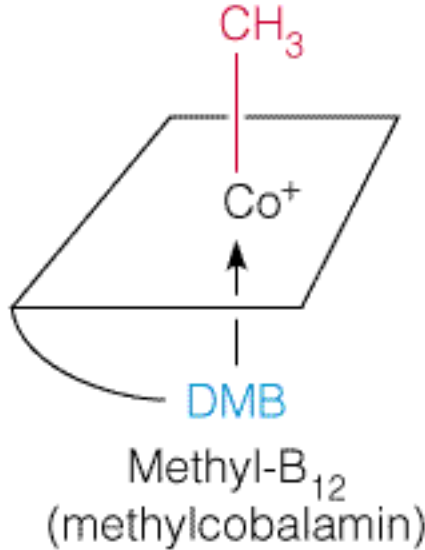
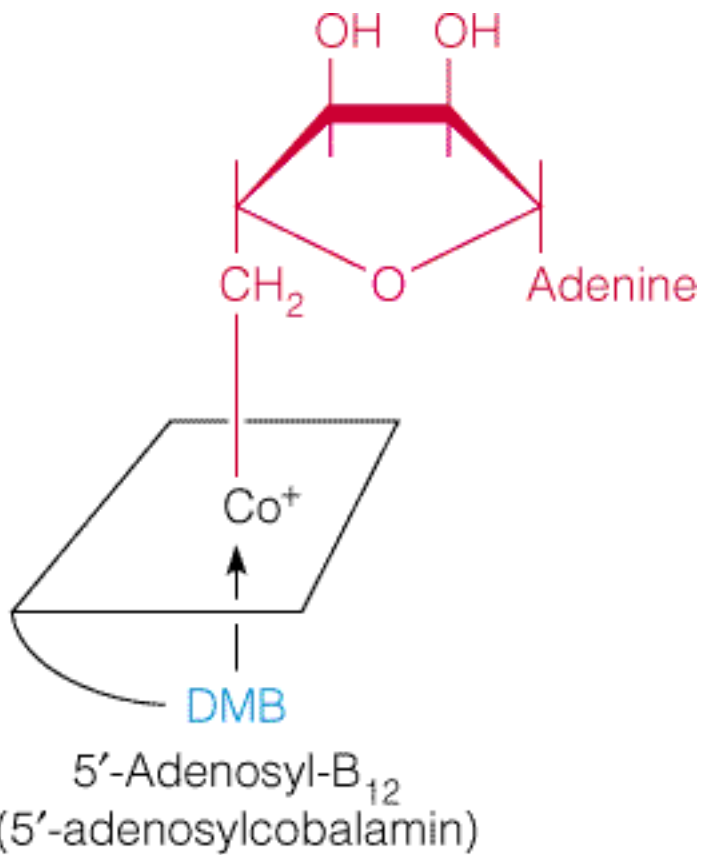
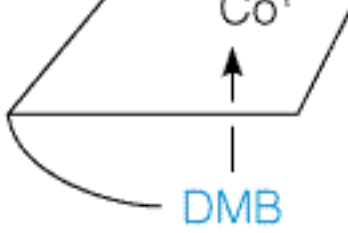

Figure 20.19: Coenzymes derived from vitamin B12





Vitamin B₁₂ as
originally isolated
(cyanocobalamin)

Figure 20.22: A relationship between folate and B12 metabolism.

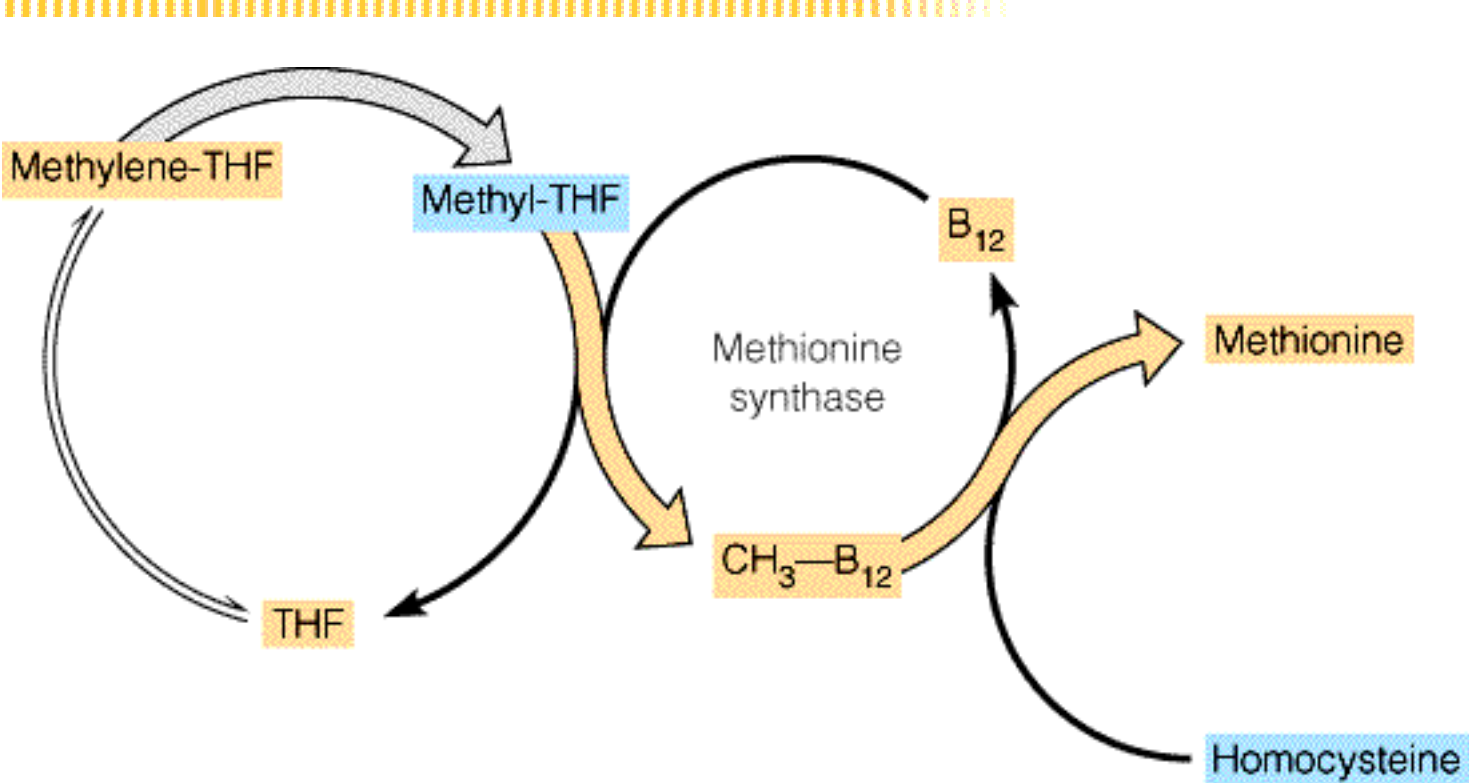
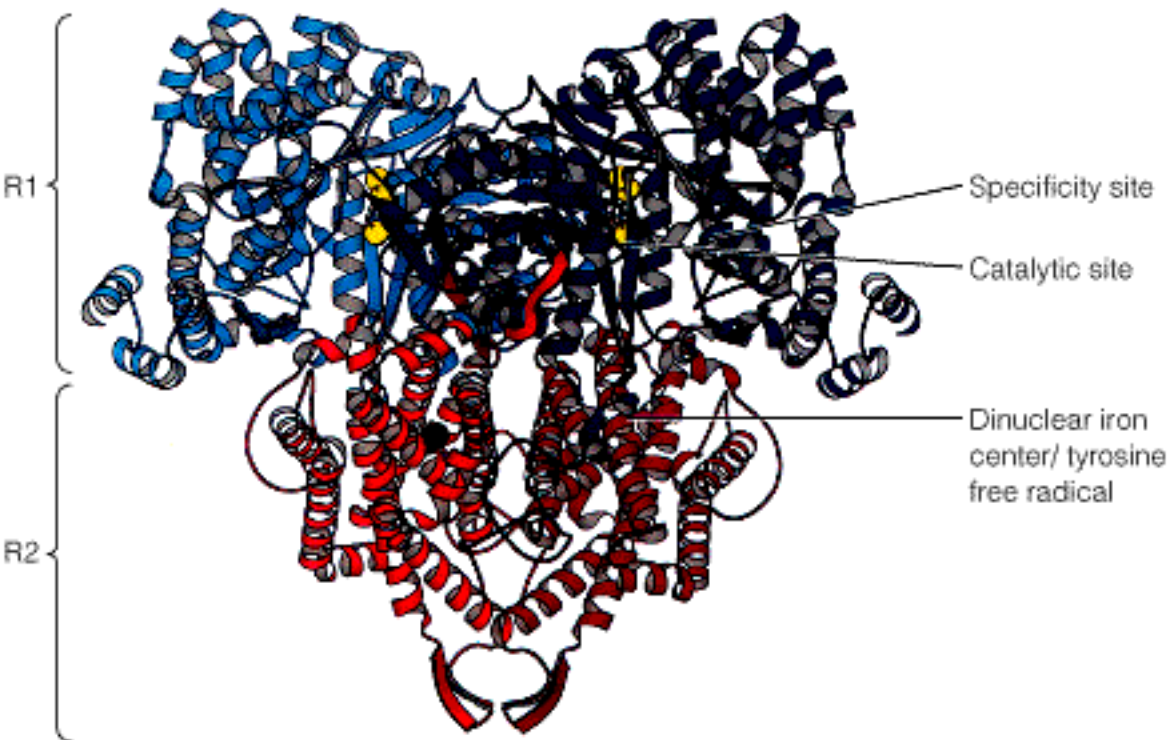
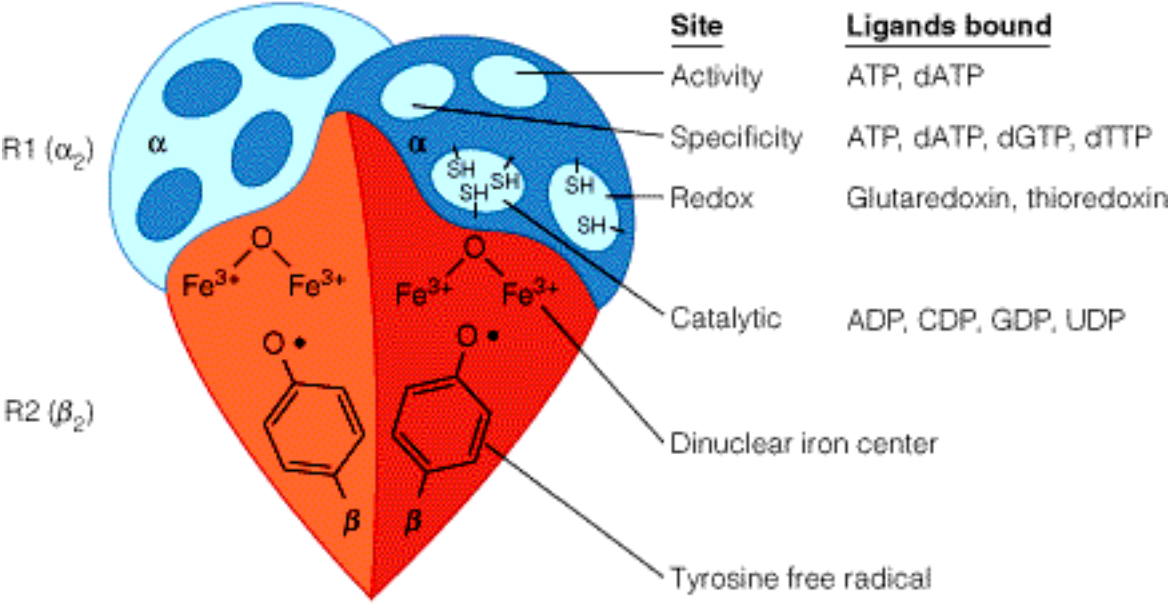

Figure 22.13: Structure of *E. coli* ribonucleoside diphosphate reductase.



(a)



(b)

(a) From U. Uhlin and H. Eklund, Nature (1994) 370:533-539. © 1994 Macmillan Magazines, Ltd.

Figure 22.14: Evidence that tyrosine 122 in *E. coli* R2 protein carries the essential free radical.

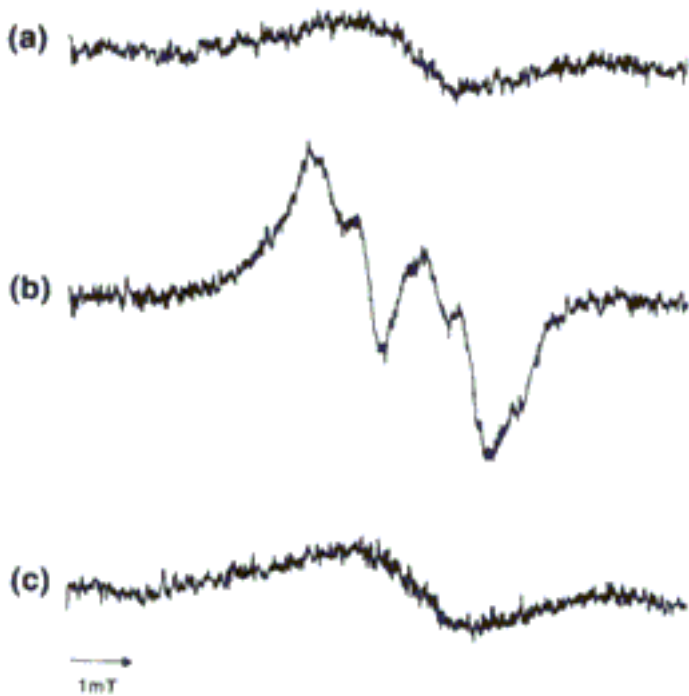

From Å. Larsson and B. M. Sjöberg, EMBO J. (1986) 3:2038. By permission of Oxford University Press.

Hydroxyurea

Hydroxyurea is an inhibitor of the enzyme [ribonucleotide reductase](#). **Hydroxyurea's** mechanism of inhibition involves destruction of the free radical in the enzyme that is essential for its activity ([Figure 21.15](#)).

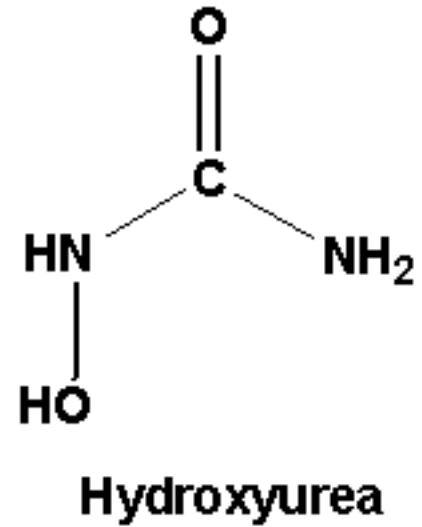

See also: [Ribonucleotide Reductase and Deoxyribonucleotide Biosynthesis](#), [Regulation of Ribonucleotide Reductase](#)

Glutaredoxin



A proposed mechanism of action of [ribonucleotide reductase](#) is shown in [Figure 22.15](#). Reduction of ribonucleotides requires electrons. These ultimately come from [NADPH](#) and are delivered to ribonucleotide reductase by either [thioredoxin](#) or [glutaredoxin](#), as shown in [Figure 22.16](#).

See also: [Ribonucleotide Reductase and Deoxyribonucleotide Biosynthesis](#), [Glutathione](#), [Glutathione Reductase](#), [Metabolism of Glutathione](#)

Figure 22.16: Reductive electron transport sequences in the action of rNDP reductase.

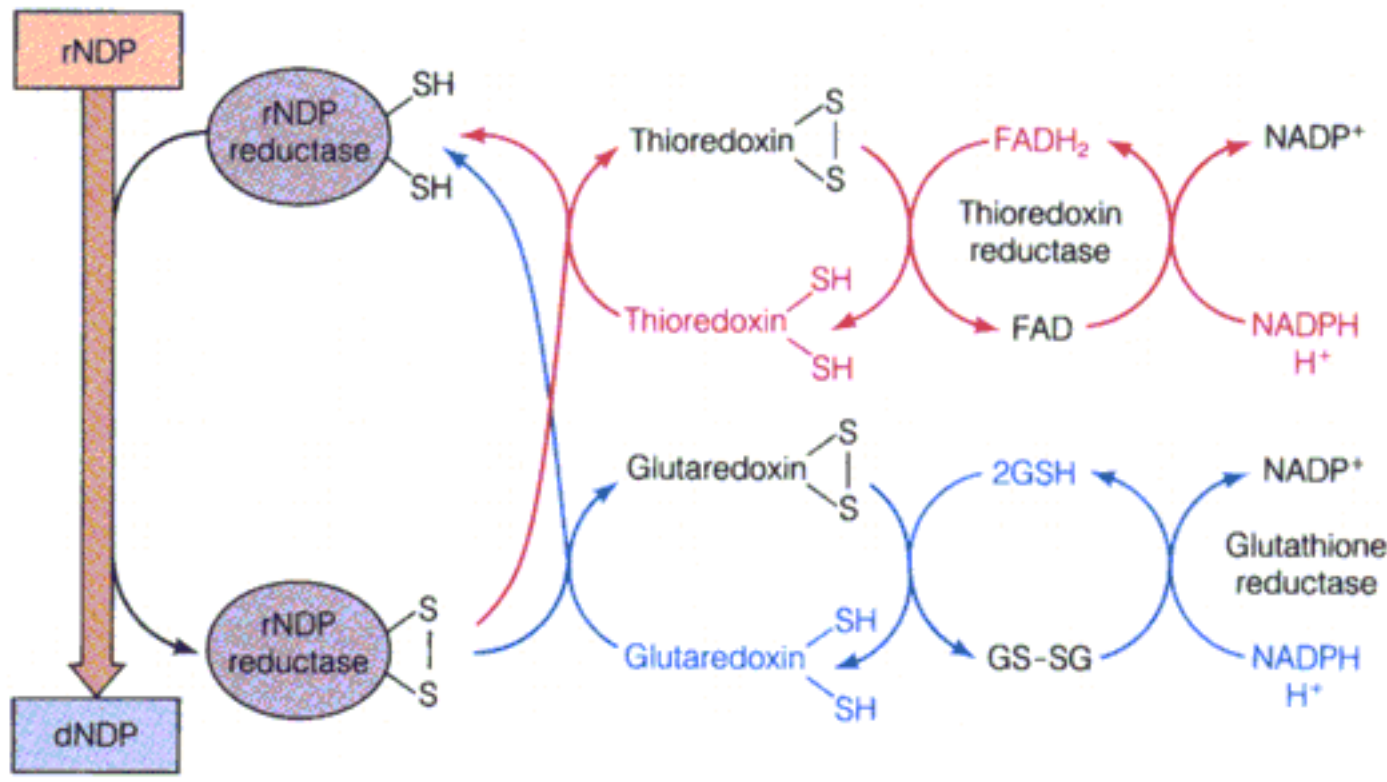

Glutathione Reductase

Glutathione reductase is an enzyme that uses the reducing ability of [NADPH](#) to regenerate reduced [glutathione](#) from oxidized glutathione (see [here](#)).

See also: [Ribonucleotide Reductase and Deoxyribonucleotide Biosynthesis](#), [Metabolism of Glutathione](#), [Figure 22.16](#)

INTERNET LINK: [Glutathione Metabolism](#)

Unnumbered Item

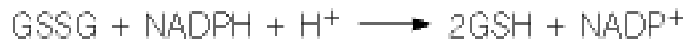

Metabolism of Glutathione

Glutathione is a tripeptide, γ -glutamylcysteinylglycine, which protects against two kinds of metabolic stress:

1. It can nonenzymatically reduce substances, such as peroxides or free radicals, which accumulate in cells under oxidizing conditions. By maintaining an intracellular reducing environment, **glutathione** prevents intracellular protein thiols from oxidizing to disulfides.
2. In conjunction with **glutathione S-transferases**, **glutathione** participates in detoxification of many substances, such as organic halides, fatty acid peroxides derived from lipid oxidation, and products derived from radiation-damaged DNA. **Glutathione** reacts with compounds as shown [here](#).

In fertilized eggs, the sulfur amino acid called ovothiol (see [here](#)) plays a role comparable to that of **glutathione**. That is, ovothiol protects the egg against oxidative damage by peroxides produced at the egg surface early in fertilization. Oxidized ovothiol is in turn reduced by **glutathione**.

See also: [Metabolism of Sulfur-Containing Amino Acids](#), [Antioxidants](#), [Reactive Oxygen](#) (from Chapter 15), [Oxygen Metabolism and Human Disease](#) (from Chapter 15), [Glutathione Peroxidase](#), [Glutathione Reductase](#)

INTERNET LINKS: [Glutathione Metabolism](#)

Unnumbered Item

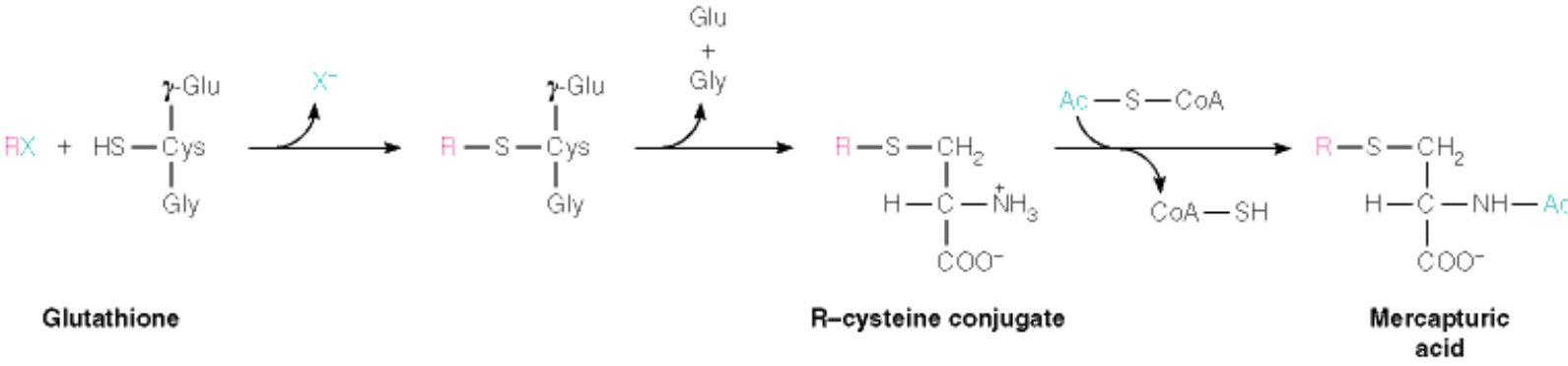

Unnumbered Item

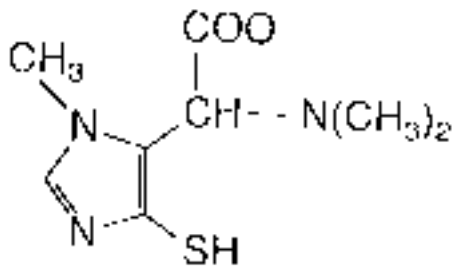

Ovothiol

Deoxyadenosine Diphosphate (dADP)

dADP is a deoxyribonucleotide made from ADP in the reaction catalyzed by **ribonucleotide reductase**, as follows:

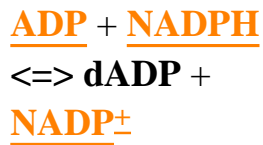

Phosphorylation of **dADP** yields **dATP**, a substrate for DNA polymerase in synthesis of **DNA**.

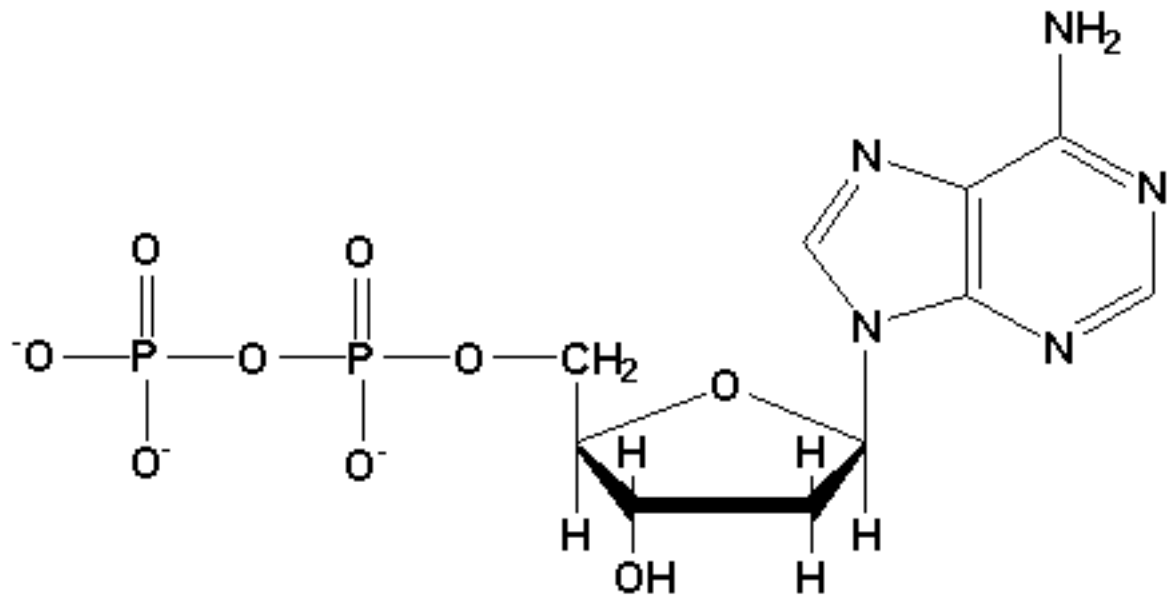

Deoxyadenosine diphosphate

See also: **Nucleotides**

Inosine

Dephosphorylation of inosine monophosphate ([IMP](#)) in purine catabolism yields **inosine**.

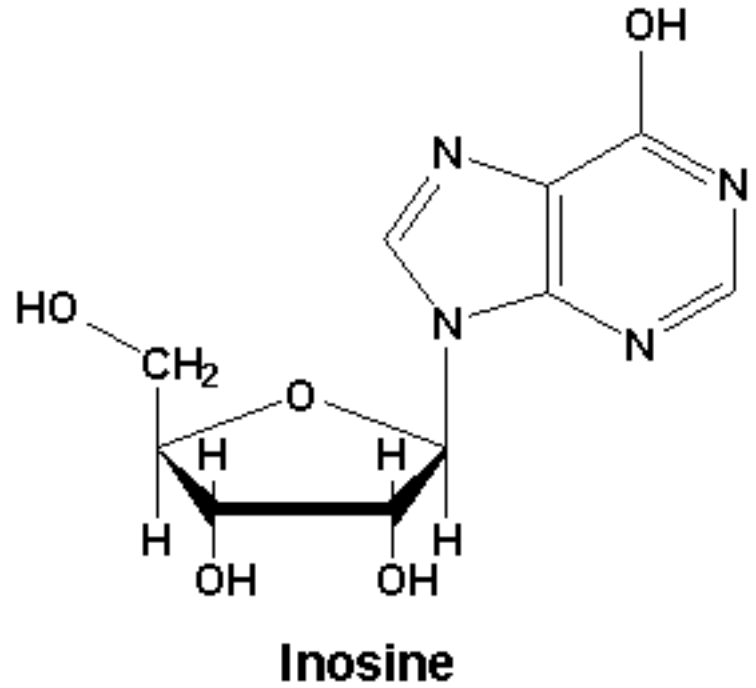

See also: [Purine Degradation](#), [Figure 22.7](#)

Allantoin

Oxidation of [uric acid](#) in non-primate animals yields **allantoin**.

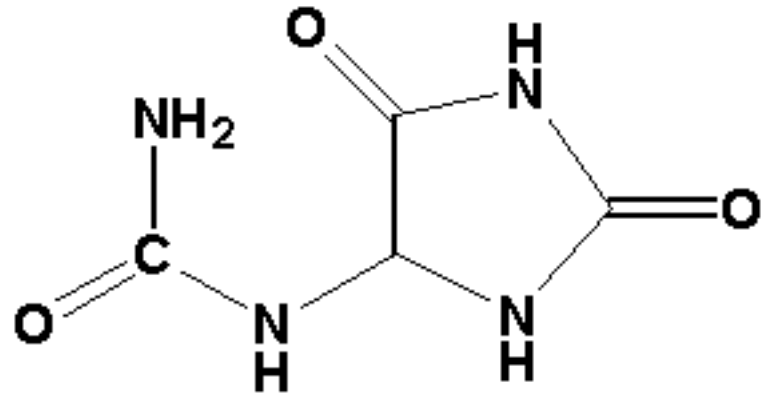

Allantoin

See also: [Purine Degradation](#), [Figure 22.8](#)

Figure 22.8: Catabolism of uric acid to ammonia and CO₂.

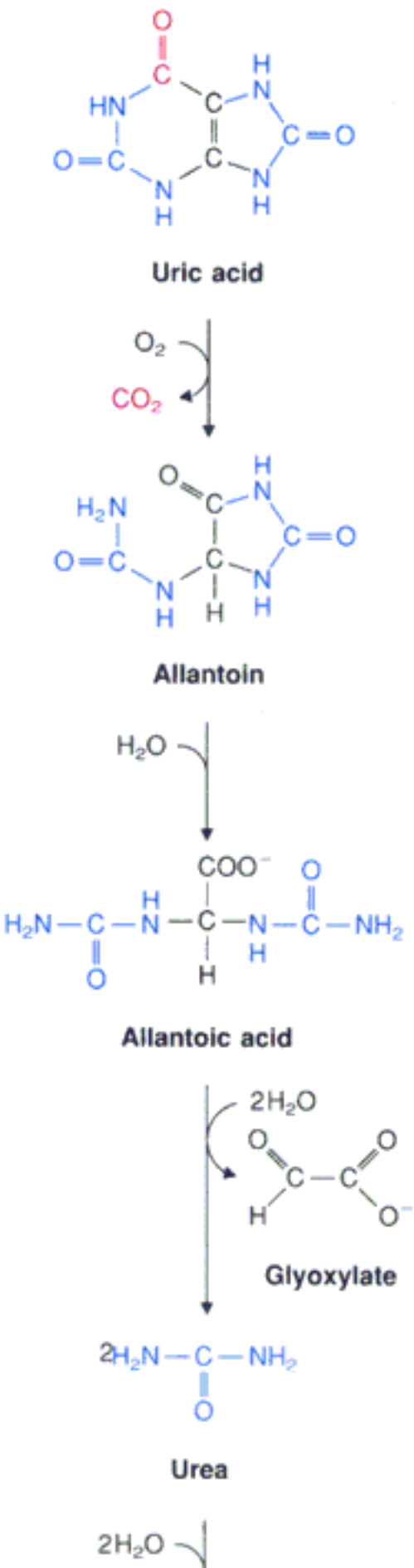

Urea

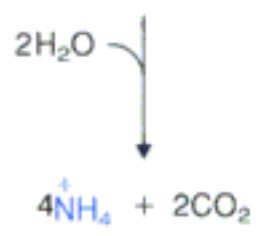

Allantoic Acid

Hydrolysis of [allantoin](#) in non-primate animals yields **allantoic acid**.

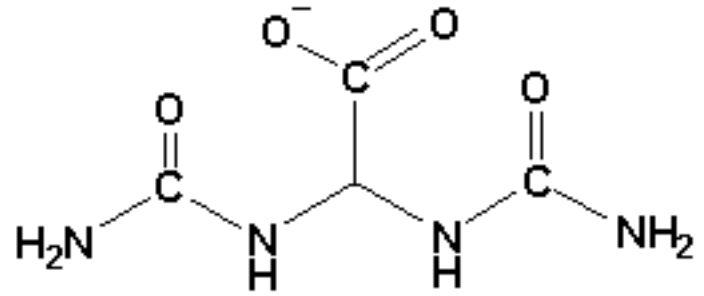

Allantoic Acid

See also: [Purine Degradation](#), [Figure 22.8](#)

Sarcosine

Sarcosine is an intermediate in amino acid metabolism and is found in many tissues.

See also: [Amino Acids Not In Proteins](#)

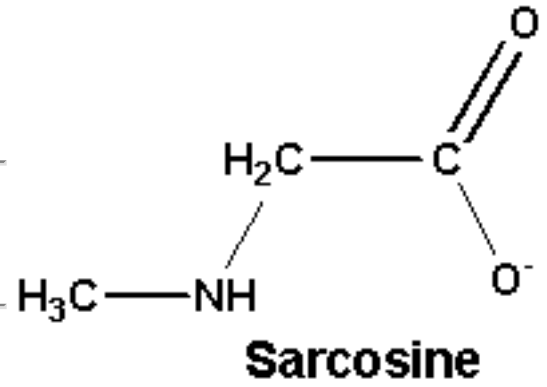

Azaserine

Azaserine is an antibiotic that is a potent inhibitor of **purine** nucleotide synthesis. **Azaserine** is similar in structure to **glutamine** and is an irreversible inhibitor of glutamine amidotransferases, which catalyze the ATP-dependent transfer of the amido nitrogen of glutamine to an acceptor. Four such reactions occur in nucleotide synthesis.

See also: [Nucleotides](#), [Amino Acids Not In Proteins](#), [De Novo Biosynthesis of Purine Nucleotides](#) (from Chapter 22)

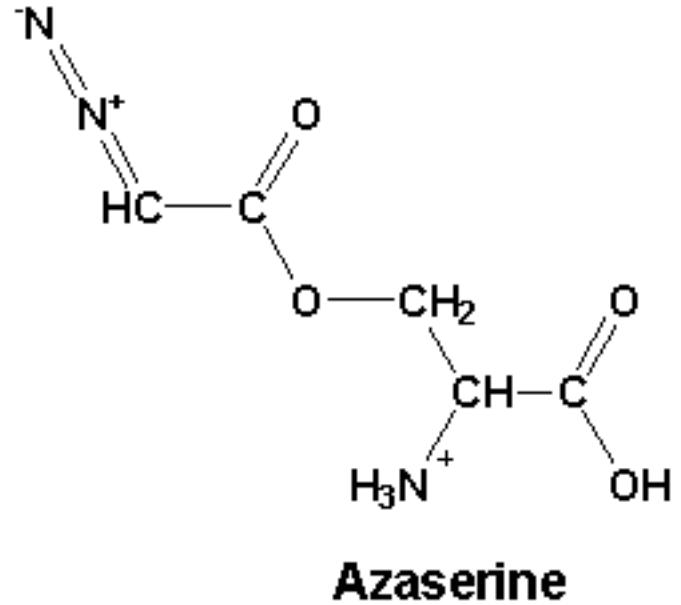

3-Hydroxyacyl-CoA Dehydrogenase

3-Hydroxyacyl-CoA Dehydrogenase catalyzes the reaction that follows:

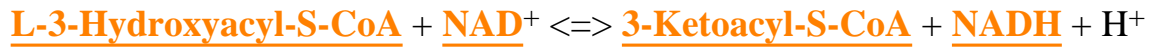

This reaction is part of the β oxidation pathway for catabolism of fatty acids ([Figure 18.16](#)).

See also: [\$\beta\$ Oxidation of Saturated Fatty Acids](#), [Oxidation of Unsaturated Fatty Acids](#), [Oxidation of Odd-Numbered Fatty Acids](#), [Peroxisomal](#)

INTERNET LINK: [Fatty Acid Metabolism](#)

Lysolecithin

Lysolecithin is another name for 1-acylglycerophosphorylcholine, which is [phosphatidylcholine](#) with the fatty acid at position 2 removed. **Lysolecithin** is an excellent detergent, capable of solubilizing membranes, and causing cells (such as erythrocytes) to lyse.

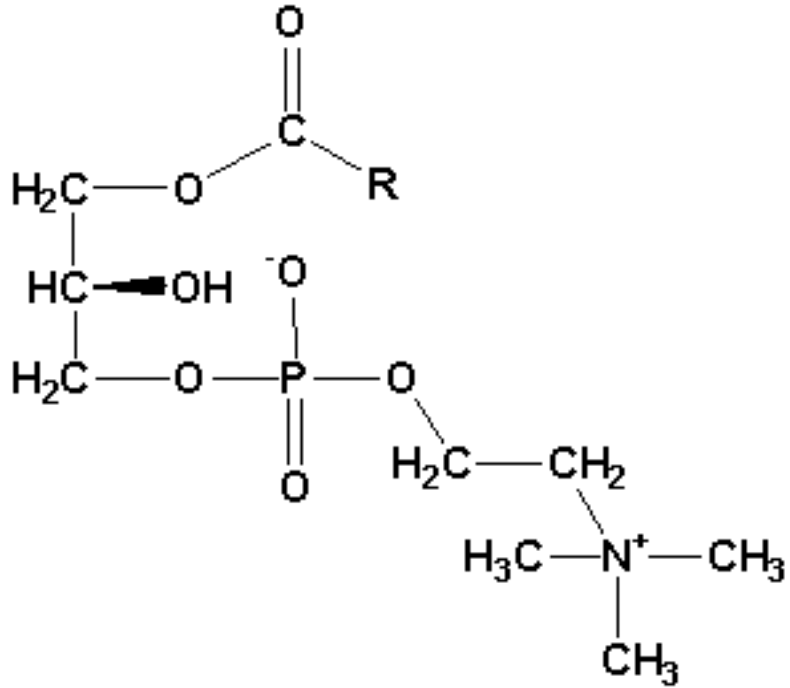

1-Acylglycerophosphorylcholine (lysolecithin)

See also:

[Glycerophospholipid](#)
[Metabolism in Eukaryotes](#),
[Glycerophospholipids](#)

INTERNET LINKS

1. [Glycerolipid Metabolism](#)
 2. [Phospholipid Catabolism](#)
-

Phosphatidylglycerol

Phosphatidylglycerol is an intermediate in synthesis of cardiolipin. It is made by hydrolysis of phosphatidylglycerol-3-phosphate ([Figure 19.4](#)).

Subsequently, two **phosphatidylglycerols** are joined together to make **cardiolipin** ([Figure 19.4](#)).

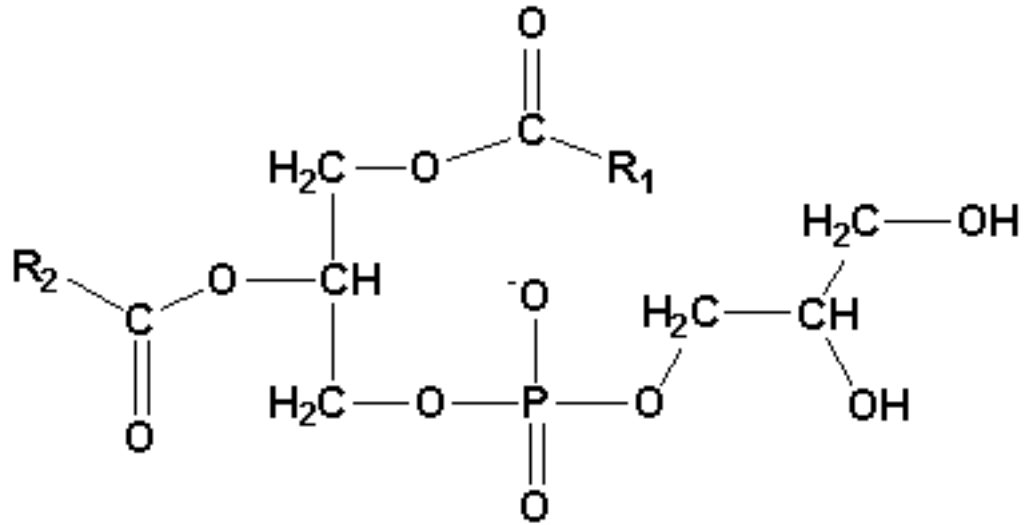

Phosphatidylglycerol

See also: [Glycerophospholipid Pathway](#), [Phosphatidylglycerol-3-Phosphate](#), [Glycerophospholipid Biosynthesis in Bacteria](#), [Glycerophospholipids](#), [Glycerophospholipid Pathway](#),

INTERNET LINKS

1. [Glycerolipid Metabolism](#)
 2. [Phospholipid Catabolism](#)
-

Ethanolamine

Ethanolamine is an amino alcohol which can be exchanged for serine on phosphatidylserine, to form **phosphatidylethanolamine** plus free **serine** (see [here](#)). The reverse reaction is one way to make free **ethanolamine**, starting with phosphatidylethanolamine.

See also: [CDP-Diacylglycerol](#), [Glycerophospholipid Pathway](#), [Serine](#)

INTERNET LINKS

1. [Glycerolipid Metabolism](#)
 2. [Phospholipid Catabolism](#)
-

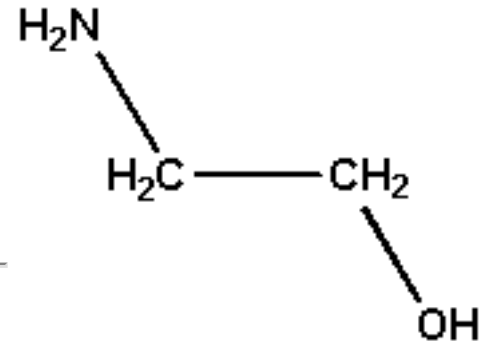

Ethanolamine

Figure 26.29: DNA binding faces of λ Cro, λ cI repressor, and CRP, showing the helix-turn-helix motif.

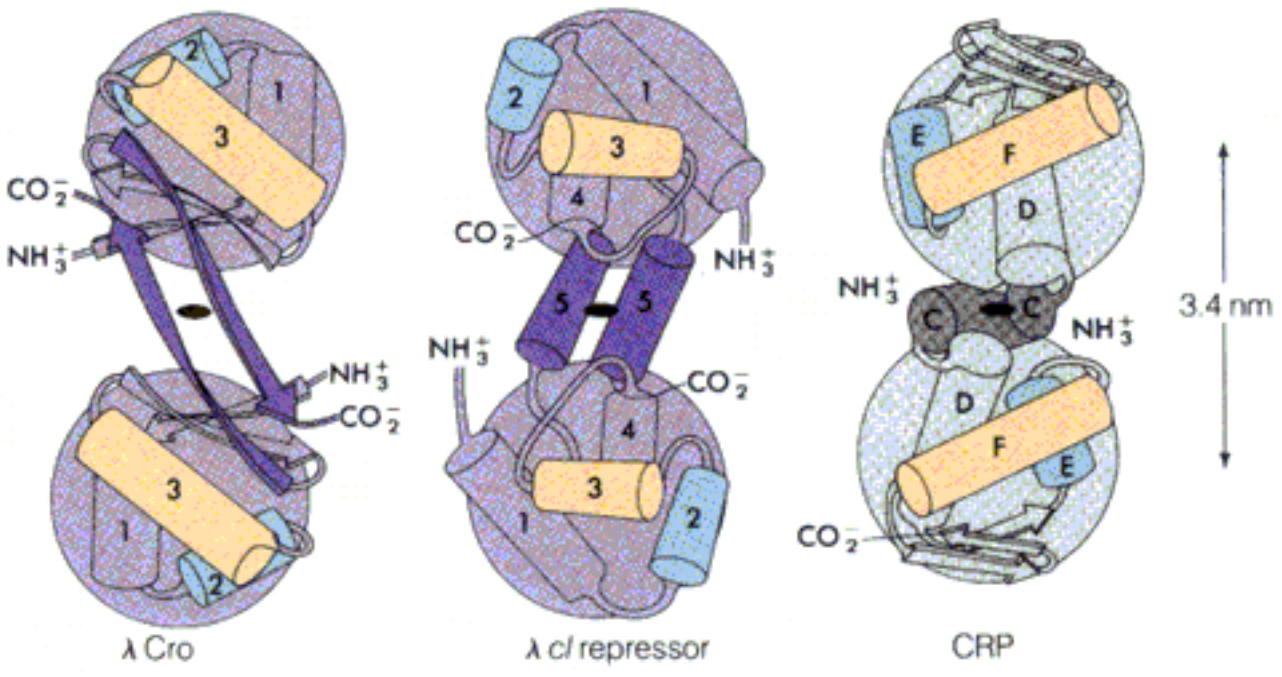

Courtesy of T. A. Steitz and I. T. Weber.

Figure 26.30: Conserved residues in the DNA-binding helices of λ cI repressor and Cro.

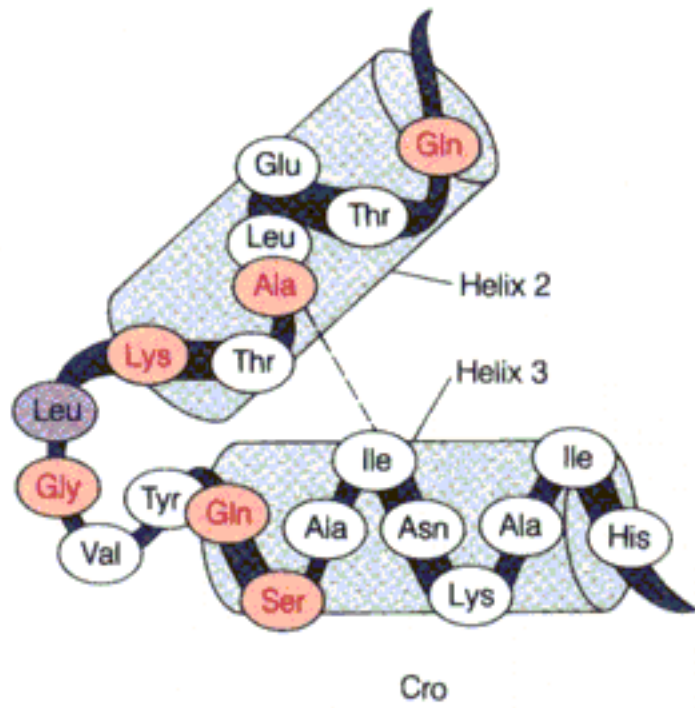
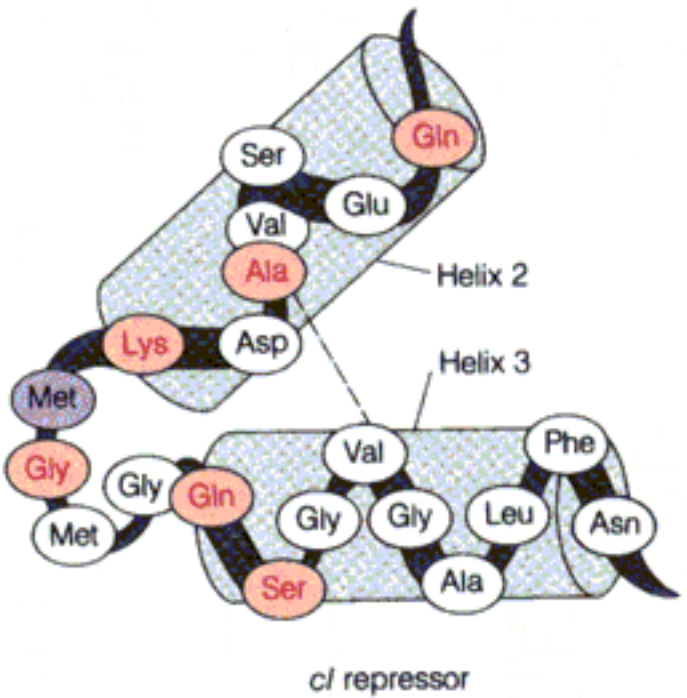

From M. Ptashne, A Genetic Switch: Gene Control and Phage λ (Cambridge, Mass.: Cell Press & BSI, 1986).

Figure 26.31: Specific amino acid-nucleotide contacts for cI and Cro repressors.

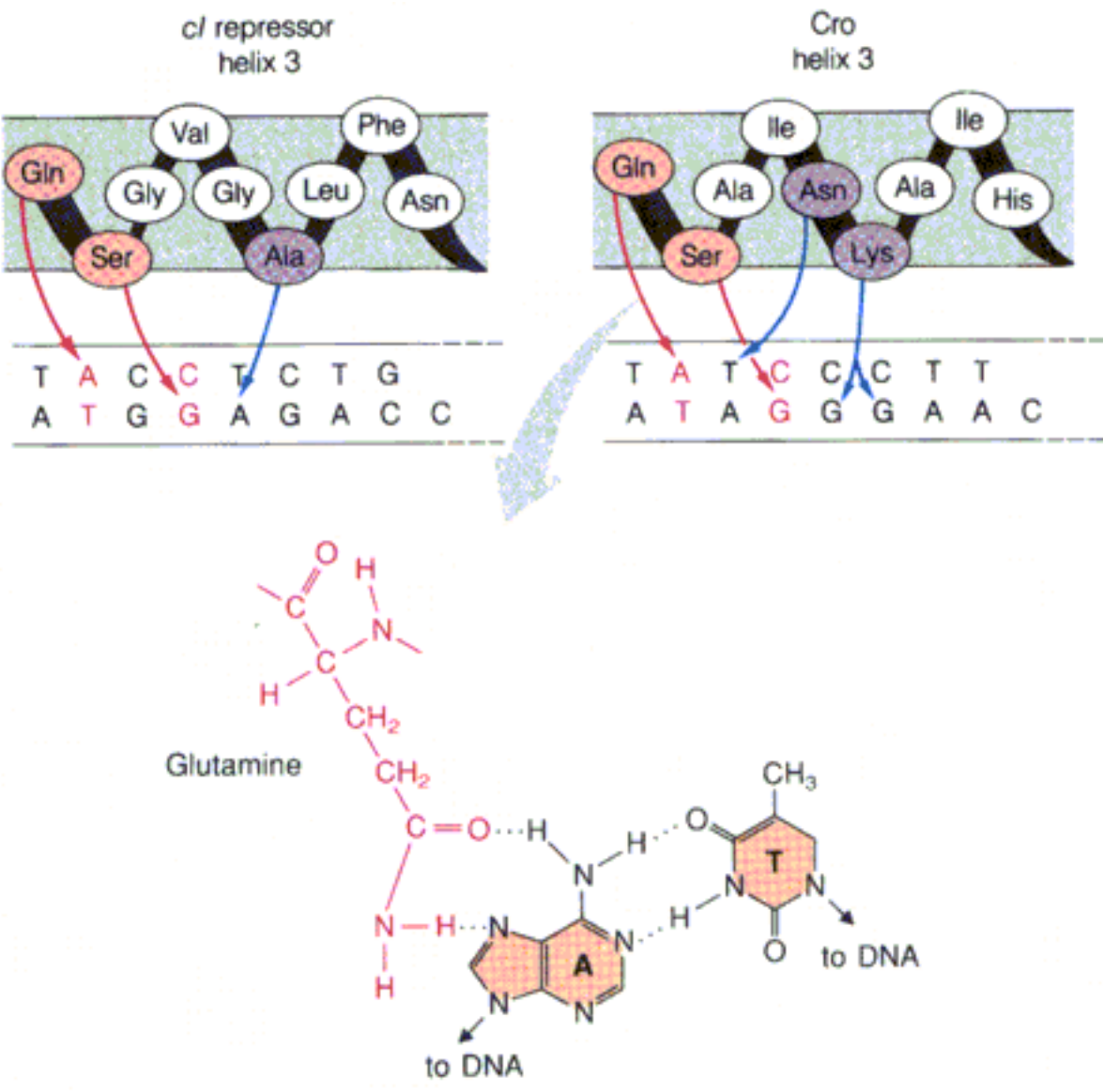

From M. Ptashne, A Genetic Switch: Gene Control and Phage λ (Cambridge, Mass.: Cell Press & BSI, 1986).

λ Phage Biology

λ Phage Biology - Phage λ infection can have two possible outcomes--a lytic cycle of growth, comparable to that of phage T4, or lysogenization, in which the viral chromosome circularizes and undergoes site-specific integration into the host-cell chromosome ([Figure 25.17](#)). In the lysogenic state, the phage chromosome is maintained in the host genome with repression of nearly all viral genes. This is accomplished by the binding of a λ encoded repressor to two operators in λ . Phage mutants defective in establishing or maintaining lysogeny have phenotypes comparable to those defective in *lac* regulation. The major λ phenotypes and comparisons to *lac* operator mutations are summarized in [Table 26.2](#).

The transcriptional repression can be broken, however, leading to excision of the viral chromosome from the host genome as a circular DNA, followed by replication of viral DNA, followed by activation of genes needed to assemble virus particles.

The virus must rely on the following four distinct patterns of gene expression needed for its four physiological states:

1. Infection leading to lytic growth;
2. Infection leading to the establishment of lysogeny,
3. Long-term maintenance of lysogeny, and
4. The breaking of lysogeny with subsequent lytic growth.

See also: [Transcription Regulation in Phage \$\lambda\$](#)

Table 26.2



<i>lac</i> Phenotype	Corresponding λ Phenotype	Regulatory Abnormality
Inducer-constitutive, recessive	Clear-plaque; cannot establish lysogeny	Repressor defective in operator binding
Operator-constitutive, cis-dominant	Virulent; can replicate in a superinfected immune lysogen	Operator unable to bind repressor
Noninducible, trans-dominant	Noninducible (cannot be induced by UV or other treatments)	Repressor cannot bind inducer or be inactivated

Sedoheptulose-1,7-Bisphosphatase

Sedoheptulose-1,7-bisphosphatase is an enzyme of the Calvin cycle that catalyzes the following reaction:

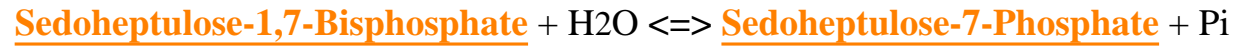

See also: [Calvin Cycle](#), [Pentose Phosphate Pathway](#)

INTERNET LINKS:

1. [CO₂ Fixation in Bacteria](#)
 2. [CO₂ Fixation in Plants](#)
-

Anthranilate

Anthranilate is a metabolic intermediate in **tryptophan** biosynthesis.

See also: [Metabolism of Aromatic Amino Acids and Histidine](#), [Chorismate](#), [Figure 21.14](#)

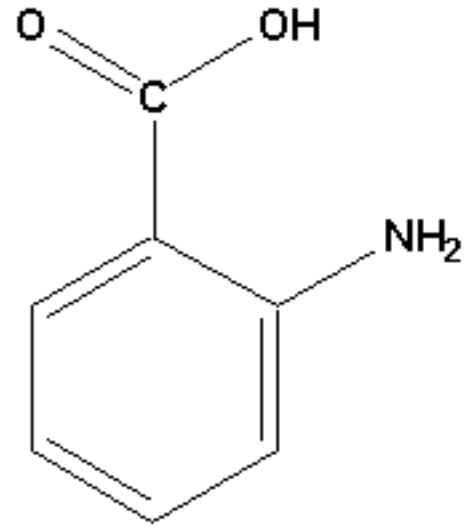

Anthranilic Acid (Anthranilate)

Phytanic Acid

Phytanic acid is an unusual fatty acid which accumulates in patients with Refsum's disease. **Phytanic acid** is derived from phytol, a constituent of chlorophyll ([Figure 18.20](#)). **Phytanic acid** contains a methyl group on carbon number three and this prevents β -oxidation from occurring. In this circumstance, α -oxidation ([Figure 18.20](#)) would normally handle the problem, but patients with Refsum's disease cannot undergo α -oxidation, so **phytanic acid** accumulates.

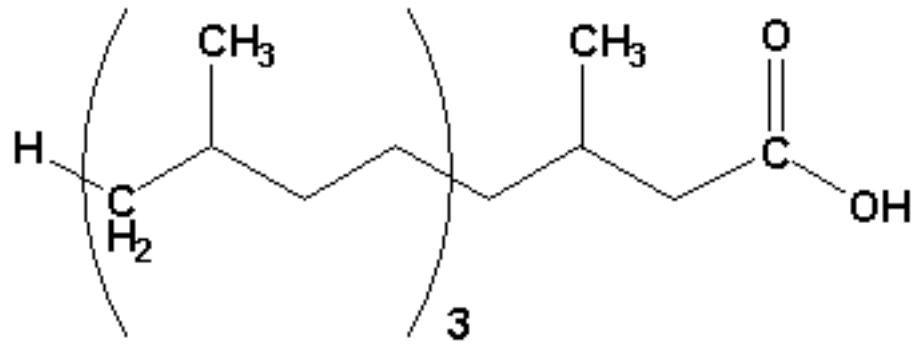

Phytanic Acid

See also: [\$\beta\$ -Oxidation](#), [Chlorophyll](#)

Figure 18.20: The α -oxidation pathway for phytanic acid oxidation.

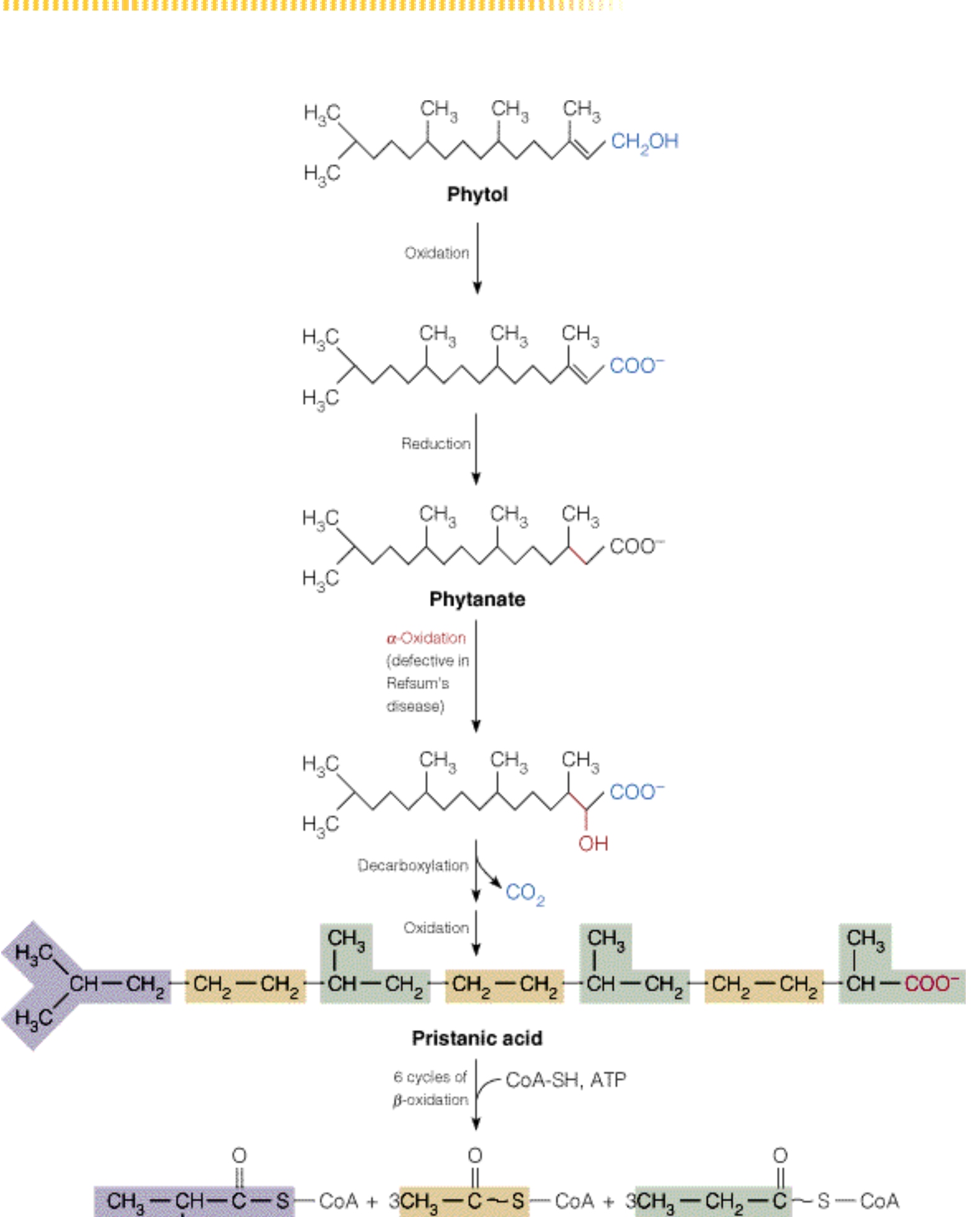

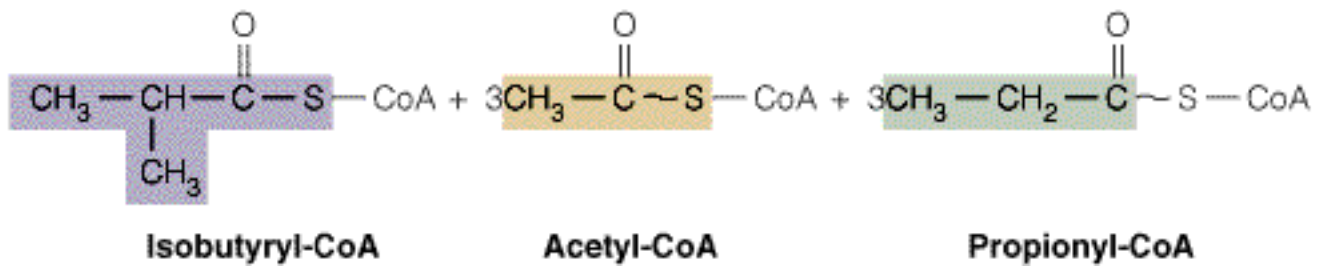

Galacturonic Acid

Galacturonic acid is a uronic acid derivative of [galactose](#).

See also: [Uronic Acids](#)

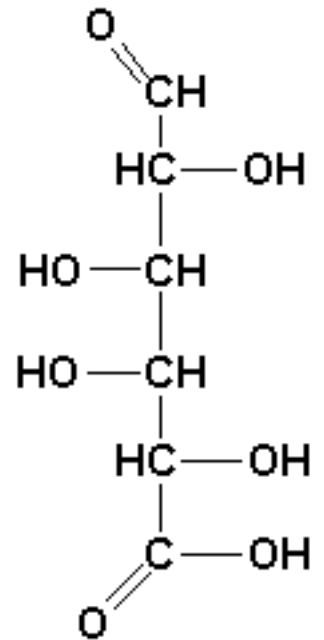

Galacturonic Acid

Mannuronic Acid

Mannuronic acid is a uronic acid derivative of [mannose](#).

See also: [Uronic Acids](#)

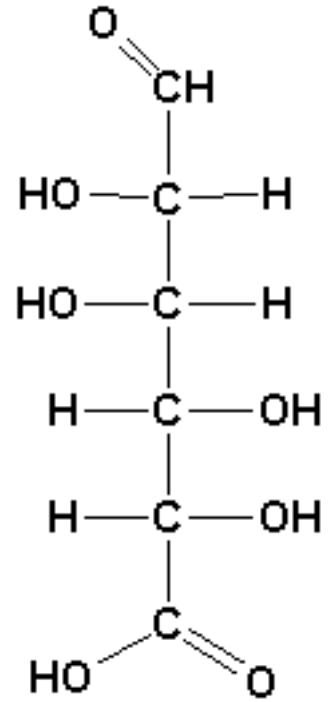

Mannuronic Acid

Heparin

Heparin (see [here](#)) is a heterogeneous polysaccharide polymer of D-iduronate-2-sulfate linked α 1->4 to N-sulfo-D-glucosamine-6-sulfate. This repeating unit of the polymer is shown at the right.

The sulfates in the molecule make it very negatively charged.

Heparin is found in mast cells lining the walls of arteries. **Heparin** blocks blood clotting and is used clinically for that purpose. In the body, release of **heparin** plays a role in preventing a clot from becoming dangerously large.

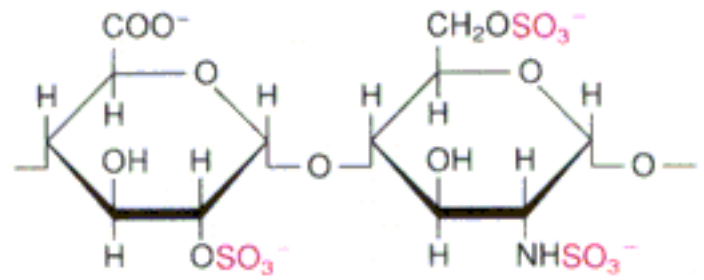

Heparin

See also: [Polysaccharides](#), [Blood Clotting](#)

Proteoglycans

Proteoglycans are glycoproteins that are very rich (over 50%) in [carbohydrates](#).

The protein-carbohydrate, or **proteoglycan**, complex in cartilage is a filamentous structure built on a single long [hyaluronic acid](#) molecule, to which extended core proteins are attached noncovalently. The core proteins, in turn, have [chondroitin sulfate](#) and [keratan sulfate](#) chains covalently bound to them through [serine](#) side chains. In cartilage, this kind of structure binds [collagen](#) and helps hold the collagen fibers in a tight, strong network. The binding apparently involves electrostatic interactions between the sulfate and/or carboxylate groups of the **proteoglycan** complex and the basic side chains in collagen.

See also: [Glycoproteins](#)

INTERNET LINK: [Proteoglycans](#)

Table 9.6



Glycoprotein	Oligosaccharide ^a and Attachment Site (in red)	No. of Chains in Proteins	Function of Protein
Fish antifreeze protein	Gal-GalNAc-Thr	From 4 to 50 in different proteins	Lowering of body fluid freezing point
Sheep submaxillary mucin	Sia-GalNAc-Ser (or Thr)	Many	Lubrication
Ribonuclease B	(Man) ₆ -GlcNAc-GlcNAc-Asn	1	Enzyme
Hen ovalbumin	Man-Man \ \ Man-GlcNAc-GlcNAc-Asn Man-Man Man (only one of many variants)	1	Storage protein in egg white
Human IgG	Sia-Gal-GlcNAc-Man \ \ Man-GlcNAc-GlcNAc-Asn Fuc Sia-Gal-GlcNAc-Man (many other variants in antibodies)	2 or more	Antibody molecule

^aFor compactness, the anomeric forms and linkages have been eliminated. For details, see R. C. Hughes, *Glycoproteins* (London: Chapman and Hall, 1983).

Unnumbered Item



chapter two

outline | concepts
terminology | quizzing

1	2	3	4
5	6	7	8
9	10	11	12
13	14	15	16
17	18	19	20
21	22	23	24
25	26	27	28

help | index

Outline

Introduction ([Figure 2.1](#))

[Non-Covalent Interactions](#) (2-40 kJ/mol)

[Hydrogen Bonds](#)

Charge-charge interactions

Other non-covalent interactions

[Covalent Bonds](#) (300-400 kJ/mol)

The Nature of Noncovalent Interactions ([Figure 2.2](#))

Charge-Charge Interactions

[Coulomb's Law](#)

The force is inversely proportional to r^2

[Dielectric Medium](#), [Dielectric Constant](#)

The medium shields charges

[Energy of Interaction](#)

The force is non-directional and inversely proportional to r

Permanent and Induced Dipole Interactions ([Figure 2.4](#), [Table 2.1](#))

[Permanent Dipole](#)

Permanent Dipole Interactions ([Figure 2.2](#))

[Induced Dipole Interactions](#)

[Dispersion Forces](#) ([Figure 2.5](#))

Molecular Repulsion at Extreme Close Approach: [Figure 2.6](#), [Table 2.2](#)

[van der Waals Radius](#)

[Hydrogen Bonds](#) ([Figure 2.7](#))

Donors/Acceptors ([Table 2.3](#))

The Role of Water in Biological Processes ([Figure 2.8](#))

[The Structure and Properties of Water](#) ([Table 2.4](#), [2.5](#), [Figure 2.9](#), [Figure 2.10](#))

-OH groups are strong [hydrogen bond donors](#)

Non-bonded electron pairs on oxygen excellent hydrogen bond acceptors.

Hydrogen bonds most clearly defined when water freezes

Unusual properties of water

- High viscosity
- High surface tension
- Density decreases on freezing
- High heat of vaporization
- High boiling point

Water as a Solvent

Hydrophilic molecules in Aqueous Solution (Figure 2.11)

Hydration shells (Figure 2.12)

Hydrophobic molecules in Aqueous Solution

Clathrate cages (Figure 2.13)

Amphipathic molecules in Aqueous Solution (Figure 2.14)

Examples = fatty acids, detergents

Structures formed

- Monolayer
- Micelles
- Bilayer vesicles

Ionic Equilibria

Acids and Bases: Proton Donors and Acceptors

Strong/Weak Acids/Bases (Table 2.6)

Ionization of Water and the Ion Product

$$[\text{H}^+][\text{OH}^-] = K_w = 1 \times 10^{-14} \text{ M}^2$$

The pH Scale and the Physiologic pH Range (Figure 2.16)

$$\text{pH} = -\log[\text{H}^+]$$

Weak Acid and Base Equilibria

Ka and pKa (Equation 2.8)

Polyprotic Acids

A Closer Look at pKa Values: Factors Affecting Acid Dissociation

Hydration favors

Electrostatic attraction opposes

Titration of Weak Acids: The Henderson-Hasselbalch Equation

Buffer Solutions (Figure 2.17, Table 2.7)

Buffers work within 1 pH unit of pKa

Buffer calculation

Molecules with Multiple Ionizing Groups: Ampholytes, Polyampholytes, and Polyelectrolytes (Figure 2.18, Figure 2.19, Diagram)

pI

Isoelectric focusing

Interactions Between Macroions in Solution

Solubility of Macroions and pH (Figure 2.20, Figure 2.21)

Repulsive effects (nucleic acids)

Attractive effects (histones to DNA)

Minimum solubility at isoelectric point

Influence of Small Ions: Ionic Strength (Figure 2.22)

Debye-Huckel Theory

Salting In - adding counterions to a point increases protein solubility

Salting Out - adding very large amounts of counterions decreases protein solubility

chapter three

outline | concepts
terminology | quizzing

1 2 3 4
5 6 7 8
9 10 11 12
13 14 15 16
17 18 19 20
21 22 23 24
25 26 27 28

help | index

Outline

Introduction

Bioenergetics

Energy, Heat, and Work

Isolated versus Open systems

Internal Energy (E) and the State of a System

Internal Energy is a Function of the State of a System

Amount of substance plus two of

- 1) Temperature (T)
- 2) Pressure (P)
- 3) Volume (V)

Heat = q (+ = system absorbs heat)

Work = w (+ = work done by system)

Energy change = ΔE

First Law of Thermodynamics

Internal Energy Change ($\Delta E = q - w$) ([Figure 3.1](#))

At constant P, $w = P\Delta V$, $q = \Delta E + \Delta n \cdot RT$

Enthalpy (H)

$H = E + PV$

At constant P, $\Delta H = \Delta E + P\Delta V$

At constant P, $\Delta H = q$

Entropy and the Second Law of Thermodynamics

The Direction of Processes

Reversible = at equilibrium

Irreversible = far from equilibrium

Spontaneous/Favorable Processes

Entropy (S) ([Table 3.1](#))

Tendency of Systems of Molecules to Randomization

$S = k \ln W$ (k = Boltzmann constant)

Second Law - "The entropy of an isolated system will tend to increase to a maximum"

value"

Free Energy: The Second Law in Open Systems

Gibbs Free Energy ([Table 3.2](#))

$$G = H - TS$$

$$\Delta G = \Delta H - T\Delta S$$

$\Delta G < 0$ means Exergonic, favorable process

$\Delta G > 0$ means Endergonic, reverse process favored

Example of Interplay of Enthalpy and Entropy ([Figure 3.3](#))

Summary of Interplay of Enthalpy and Entropy ([Figure 3.4](#), [Table 3.3](#))

1. From $\Delta G = \Delta H - T\Delta S$, favorability of a reaction depends on temperature.
2. Favorability of a reaction not related to its rate
3. Entropy of an OPEN system can decrease - energy must be expended.
4. Entropy of the whole universe must be increasing.

Free Energy and Useful Work

1. ΔG is the part of the energy change (ΔH) available to do useful work - work other than $P\Delta V$ expansion.
2. From $\Delta G = \Delta H - T\Delta S$, part of ΔH is dissipated as heat ($T\Delta S$) and is not available for useful work.
3. Efficiency = (Work accomplished)/(Theoretical work from free energy change).

Free Energy and Concentration

Chemical Potential

How Chemical Potential is Used: An Example ([Figure 3.5](#))

Free Energy and Chemical Reactions: Chemical Equilibrium

Free Energy Change and the Equilibrium Constant

ΔG° = Standard State Free Energy Change

$$\Delta G = \Delta G^\circ + RT\ln([\text{products}]/[\text{reactants}])$$

$\Delta G = \Delta G^\circ + RT\ln K$, where K is equilibrium constant

$$K = e^{(-\Delta G^\circ / RT)}$$

Free Energy Calculations: A Biochemical Example

1. $G6P \rightleftharpoons F6P$ ($\Delta G^\circ = +1.7$ kJ/mol means equilibrium concentration has more G6P than F6P)
2. Plugging this into $K = e^{(-\Delta G^\circ / RT)}$, one finds that $(F6P)/(G6P) = 0.504$
3. Since $\Delta G = \Delta G^\circ + RT\ln([\text{products}]/[\text{reactants}])$, displacements away from equilibrium will be moved towards equilibrium by corresponding force of free energy change brought about by the change. ([Figure 3.6](#))

High Energy Phosphate Compounds: Free Energy Sources in Biological Systems

Coupled Reactions

For

$A \rightleftharpoons B$ ($\Delta G^\circ = +10 \text{ kJ/mol}$) and

$C \rightleftharpoons D$ ($\Delta G^\circ = -30 \text{ kJ/mol}$),

$A + C \rightleftharpoons B + D$ ($\Delta G^\circ = +10 - 30 = -20 \text{ kJ/mol}$)

High-Energy Phosphate Compounds as Energy Shuttles ([Figure 3.7](#))

[ATP](#), [PEP](#), [Creatine Phosphate](#) (CP) ([Figure 3.8](#))

Resonance Stabilization of the Phosphate Products ([Figure 3.9](#))

Additional Hydration of the Hydrolysis Products

Electrostatic Repulsion Between Charged Products

Enhanced Resonance Stabilization or Tautomerization of Product Molecules

[Pyruvate](#)

[Creatine](#)

Release of a Proton in Buffered Solutions

Phosphate Transfer Potential ([Figure 3.7](#))

chapter twenty-three

outline | concepts
terminology | quizzing

1	2	3	4
5	6	7	8
9	10	11	12
13	14	15	16
17	18	19	20
21	22	23	24
25	26	27	28

help | index

Outline

Introduction

Interdependence of the Major Organs in Vertebrate Fuel Metabolism

Fuel Inputs and Outputs ([Figure 23.1](#), [Table 23.1](#))

Metabolic Division of Labor Among the Major Organs

[Brain](#)

[Muscle](#)

[Heart](#)

[Adipose Tissue](#)

[Liver](#)

[Blood](#)

[Hormonal Regulation of Fuel Metabolism](#)

Actions of the Major Hormones ([Table 23.2](#), [Figure 23.2](#))

[Insulin](#) ([Figure 23.2](#))

[Glucagon](#) ([Figure 23.2](#), [Figure 23.3](#))

[Epinephrine](#)

Responses to Metabolic Stress: [Starvation](#), [Diabetes](#) ([Figure 23.4](#))

Starvation ([Diagram](#))

Diabetes ([Figure 23.5](#))

[Mechanisms of Hormone Action](#) ([Figure 23.6](#))

An Outline of [Hormone Action](#) ([Figure 12.13](#), [Figure 13.18](#), [Figure 21.34](#), [Figure 23.7](#))

[Hierarchical](#) Nature of Hormonal Control ([Figure 23.8](#), [Figure 23.9](#))

Synthesis of Hormones: [Peptide Hormone](#) Precursors ([Figure 5.15](#), [Figure 23.10](#))

[Signal Transduction](#): Receptors

Experimental Study of Receptors

Agonists and Antagonists

Classes of Catecholamine Receptors (Table 23.3)

Receptors and Adenylate Cyclase as Distinct Components of Signal Transduction Systems (Figure 23.11)

Signal Transduction: G Proteins

Actions of G Proteins

Structure of G Proteins (Figure 23.12)

Consequences of Blocking GTPase (Diagram 1, #2)

G Proteins in Vision (Diagram)

A Closer Look at G Protein Subunits (Table 23.4)

Second Messenger Systems (Figure 23.14, Diagram 1, #2, Table 23.5)

The Insulin Receptor and Related Receptors with Protein Kinase Activity (Figure 23.15)

Steroid and Thyroid Hormones - Intracellular Receptors (Table 23.6, Figure 23.16, Figure 23.17, Figure 23.18)

Signal Transduction, Oncogenes, and Cancer

Viral and Cellular Oncogenes (Figure 23.19, Table 23.7)

Oncogenes in Human Tumors

Oncogenes and Cell Signalling (Figure 23.23, Figure 23.24 Table 23.7)

Plant Hormones (Figure 23.25)

chapter twenty-four

outline | concepts
terminology | quizzing

1	2	3	4
5	6	7	8
9	10	11	12
13	14	15	16
17	18	19	20
21	22	23	24
25	26	27	28

help | index

Outline

Introduction

Information Metabolism: The Major Processes ([Figure 4.23](#))

An [Overview](#) of DNA Replication ([Figure 24.1](#), [Figure 4.12](#), [Figure 4.13](#), [Figure 4.14](#), [Figure 24.2](#), [Figure 24.3](#), [Figure 24.4](#), [Figure 24.5](#), [Figure 24.6](#))

A Review of Genetic Terminology ([Figure 24.7](#), [Figure 24.8](#))

Early Insights into DNA Replication

Semiconservative Nature of DNA Replication

Sequential Nature of Replication ([Figure 24.9](#))

Origin and Direction of Replication

Units of Replication: The Replicon ([Figure 24.13](#), [Table 24.1](#))

DNA Polymerases: Enzymes Catalyzing Polynucleotide Chain Elongation

Discovery of DNA [Polymerase](#)

Structure and Activities of DNA Polymerase I

DNA Substrates for the Polymerase Reaction ([Figure 24.15](#))

Multiple Activities in a Single Polypeptide Chain

Structure of [DNA Polymerase I](#)

DNA Polymerases [II](#) and [III](#) ([Table 24.2](#))

Structure and Mechanism of DNA Polymerases

The DNA Polymerase III Holoenzyme

[Eukaryotic DNA Polymerases](#) ([Table 24.3](#))

[Replication Proteins Other than DNA Polymerases](#) ([Figure 24.23](#), [Figure 22.23](#))

[DNA Ligase](#): Discontinuous Replication of DNA ([Figure 24.3](#), [Figure 24.24](#))

[Primase](#): Synthesis of RNA Leader Sequences ([Figure 24.25](#), [Figure 24.5](#))

[Clamps and Clamp Loaders](#): Processivity

Single-Strand DNA-Binding Proteins: Maintaining Optimal Template Conformation
([Figure 24.26](#))

Helicases: Unwinding DNA Ahead of the Fork ([Figure 24.27](#), [Figure 24.28](#))

Topoisomerases: Relieving Torsional Stress

Actions of Type I and Type II Topoisomerases ([Figure 24.30](#), [Figure 24.31](#))

The Four Topoisomerases of *E. coli* ([Figure 24.33](#), [Figure 24.34](#))

Uracil-DNA N-Glycosylase: Removal of Incorporated Uracil ([Figure 24.35](#))

Reconstruction of Replication Machines ([Figure 24.6](#), [Figure 24.36](#))

Initiation of DNA Replication

Requirements for Initiation of Replication

Initiation of *E. coli* DNA Replication at *ori*^c ([Figure 24.37](#))

Plasmid DNA Replication: Control of Initiation by RNA ([Figure 24.38](#))

Mitochondrial DNA: Two Unidirectional Replication Forks ([Figure 24.39](#))

Replication of Linear Genomes ([Figure 24.40](#), [Figure 24.41ab](#), [Figure 24.41c](#), [Figure 24.42](#))

Fidelity of DNA Replication ([Figure 24.44](#))

RNA Viruses: The Replication of RNA Genomes

RNA-Dependent RNA Replicases

Replication of Retroviral Genomes ([Figure 24.45](#))

chapter twenty-eight

outline | concepts
terminology | quizzing

1	2	3	4
5	6	7	8
9	10	11	12
13	14	15	16
17	18	19	20
21	22	23	24
25	26	27	28

help | index

Outline

Introduction

The Eukaryotic Genome

Size of the Genome ([Figure 28.1](#))

Repetitive Sequences ([Figure 28.2](#))

Satellite DNA ([Figure 28.3](#))

Duplications of Functional Genes

Alu Elements

Introns

Gene Families

Multiple Variants of a Gene ([Figure 7.25](#), [Figure 7.20](#), [Figure 7.22](#))

Pseudogenes ([Figure 7.23](#))

The Physical Organization of Eukaryotic DNA: Chromosomes and Chromatin

Chromosomes

Chromatin ([Table 28.1](#))

The Nucleosome ([Figure 28.11](#))

Higher Order Chromatin Structure in the Nucleus ([Figure 28.12](#), [Figure 28.13](#))

The Cell Cycle and DNA Replication in Eukaryotes

The Cell Cycle ([Figure 28.14](#), [Figure 28.15](#), [Figure 28.16](#))

Molecular Events During Chromatin Replication

Replication of DNA ([Table 24.2](#), [Table 24.3](#))

Assembly of Nucleosomes ([Figure 28.17](#))

Origins of Replication ([Table 24.1](#), [Figure 28.18](#))

Telomeres ([Table 28.2](#), [Figure 28.19](#))

Transcription and its Control in Eukaryotic Cells

RNA Polymerase I: Transcription of the Major Ribosomal RNA Genes ([Figure 28.20](#))

RNA Polymerase III: Transcription of Small RNA Genes ([Figure 28.21](#), [Figure 28.22](#), [Figure 28.23](#))

RNA Polymerase II: Transcription of Structural Genes ([Figure 28.24](#), [Table 28.4](#))

Chromatin Structure and Transcription

The Problem of Initiation

Chromatin Remodeling ([Figure 28.27](#), [Figure 28.28](#))

Transcriptional **Elongation**

Termination of Transcription ([Figure 28.29](#))

Processing of Messenger RNA

Capping ([Figure 28.30](#))

Splicing ([Figure 28.31](#), [Table 28.5](#), [Figure 28.32](#), [Figure 28.33](#))

Alternative Splicing ([Figure 28.34](#))

Editing

Translation in Eukaryotes

Comparison with Prokaryotic Mechanisms

Ribosomes

Initiation ([Table 28.6](#), [Figure 28.35](#), [Figure 27.20](#))

Elongation and Termination

Inhibitors of Translation ([Figure 28.36](#))

Control of Translation ([Figure 28.37](#))

Protein Targeting in Eukaryotes

Proteins Synthesized in the Cytoplasm ([Figure 28.38](#))

Proteins Synthesized on the Rough Endoplasmic Reticulum ([Figure 28.39](#))

Role of the Golgi Complex ([Figure 28.40](#), [Figure 28.41](#))

The Fate of Proteins: Programmed Destruction

The Lysosomal System ([Figure 28.42](#))

Cytosolic Protein Degradation ([Figure 28.43](#), [Figure 28.44](#))

[Apoptosis](#)

[Eukaryotic DNA and Development: An Overview](#) ([Figure 28.45](#))

Main Index



Concepts, Molecules, Enzymes

<u>Number</u>	<u>A</u>	<u>B</u>	<u>C</u>	<u>D</u>	<u>E</u>	<u>F</u>	<u>G</u>	<u>H</u>
<u>I</u>	<u>J</u>	<u>K</u>	<u>L</u>	<u>M</u>	<u>N</u>	<u>O</u>	<u>P</u>	<u>Q</u>
<u>R</u>	<u>S</u>	<u>T</u>	<u>U</u>	<u>V</u>	<u>W</u>	<u>X</u>	<u>Y</u>	<u>Z</u>

Index to Items Beginning with a Number

[1,25-Dihydroxycholecalciferol](#)
[1,3 Bisphosphoglycerate](#)
[11-*cis* retinal](#)
[17-hydroxyprogesterone](#)
[2,3-Bisphosphoglycerate](#)
[2,4 Dinitrophenol](#)
[2,4-Dienoyl-CoA reductase](#)
[2-Isopentenyladenosine](#)
[2-Phosphoglycerate](#)
[3-Hydroxyacyl-ACP dehydrase](#)
[3-Hydroxyacyl-CoA Dehydrogenase](#)
[3-Ketoacyl-CoA](#)
[3-Ketoacyl-CoA transferase](#)
[3-Ketosphinganine](#)
[3-Ketosphinganine synthase](#)
[3-Phosphoglycerate](#)
[3D structural databases](#)
[4-Thiouridine](#)
[5,10-Methenyltetrahydrofolate](#)
[5,10-Methylenetetrahydrofolate](#)
[5,6,7,8-Tetrahydrofolate \(THF\)](#)
[5-Bromodeoxyuridine](#)
[5-Enoylpyruvylshikimic acid-3-phosphate](#)
[5-Fluorouracil](#)
[5-Hydroxymethylcytosine](#)
[5-Hydroxymethyluracil](#)
[5-Hydroxymethyluracil](#)
[5-Iododeoxyruridine](#)
[5-Methylcytosine](#)
[5-Methylcytosine](#)
[5-Methyltetrahydrofolate](#)

5-Phosphoribosylamine (PRA)

6-Mercaptopurine

6-Methylpterin

6-Phosphogluconate

6-Phosphogluconate dehydrogenase

6-Phosphogluconolactone

6-Thioguanine

7,8-Dihydrofolate (DHF)

7-Dehydrocholesterol

8-Hydroxy-5-deazaflavin

8-Oxoguanine

Index to Items Beginning with 'A'



[Back to Main Index](#)

- [A₀](#)
- [Abscisic acid](#)
- [Acetaldehyde](#)
- [Acetate thiokinase](#)
- [Acetic acid \(acetate\)](#)
- [Acetoacetate](#)
- [Acetoacetyl-CoA](#)
- [Acetone](#)
- [Acetyl-ACP](#)
- [Acetyl-CoA](#)
- [Acetyl-CoA carboxylase](#)
- [Acetyl-CoA-ACP transacylase](#)
- [Acetylcholine](#)
- [Acidic amino acids and their amides](#)
- [Aconitase](#)
- [ACTH](#)
- [Actin and myosin](#)
- [Actinomycin D](#)
- [Action potential](#)
- [Active transport mechanisms](#)
- [Acyclovir](#)
- [Acyl carrier protein \(ACP\)](#)
- [Acyl groups](#)
- [Acyl-ACP](#)
- [Acyl-CoA](#)
- [Acyl-CoA dehydrogenase \(FAD-linked\)](#)
- [Acyl-CoA: cholesterol acyltransferase \(ACAT\)](#)
- [Acylcarnitine](#)
- [Adenosuccinate synthetase](#)

Adenine

Adenine nucleotide as precursors of enzymes

Adenosine

Adenosine deaminase

Adenosine monophosphate

Adenosine triphosphate

Adenosine-5'-phosphosulfate

Adenylate cyclase

Adenylate kinase

Adenylosuccinate

Adenylosuccinate lyase

Adenylyl transferase

Adenosine diphosphate

Adipocytes

Adipocytes

Adipose tissue metabolism

ADP

ADP-glucose

Adrenal Corticotrophic Hormone (ACTH)

Aerobic vs anaerobic glycolysis

Affinity label

AIDS and the immune response

Alanine

Albumin

Alcohol fermentation

Alcohol dehydrogenase

Aldolase

Aldolase (Calvin cycle)

Aldolase b

Aldosterone

Aliphatic Amino Acids

Alkaloids

Allantoic acid

Allantoin

Allolactose

[Allopurinol](#)

[α- Amylose](#)

[α- Helix](#)

[α- Lactalbumin](#)

[α- Amanitin](#)

[α- Ketobutyrate](#)

[α- Ketoglutarate](#)

[α- Ketoglutarate dehydrogenase](#)

[Ames test](#)

[Amino acid 1 and 3 letter codes](#)

[Amino acid degradation](#)

[Amino Acid Information](#)

[Amino acids](#)

[Amino acids not in proteins](#)

[Amino acyl tRNA synthetases](#)

[Amino sugar biosynthesis](#)

[Aminoacylated tRNA formation](#)

[Aminotransferases](#)

[Ammonia transport in the body](#)

[AMP](#)

[AMP deaminase](#)

[AMP-dependent protein kinase](#)

[Amphipathic](#)

[Ampholytes](#)

[Amygdalin](#)

[Amylopectin](#)

[Amylose](#)

[Amytal](#)

[Anaerobic process of generating metabolic energy](#)

[Analysis of kinetic data](#)

[Anaplerotic pathways](#)

[Androgens](#)

[Androstenedione](#)

[Anion channel protein](#)

[Ankyrin](#)

Anomers

Anthranilate

Antibiotic inhibition of translation

Antibody diversity

Antibody structure

Anticodons

Antigens

Antimycin A

Antioxidants

Antisense RNA

Aphidicolin

Apoprotein A-I

Apoprotein A-II

Apoprotein B-100

Apoprotein B-48

Apoprotein C-I

Apoprotein C-II

Apoprotein C-III

Apoprotein D

Apoprotein E

Apoproteins (apolipoproteins)

Apoptosis

araA (arabinosyladenine)

araATP (arabinosyladenine triphosphate)

Arabinose

Arabinose operon

araC (arabinosylcytosine)

Arachidonic acid

Arachidonyl-CoA

araCTP (arabinosylcytosine triphosphate)

Arginase

Arginine

Arginine metabolism

Argininosuccinase

Argininosuccinate

[Argininosuccinate synthetase](#)

[Aromatic amino acid utilization](#)

[Aromatic amino acids](#)

[Asparagine](#)

[Asparagine synthetase](#)

[Aspartate carbamoyltransferase](#)

[Aspartic acid](#)

[Aspartic- \$\beta\$ -semialdehyde](#)

[Aspartokinase](#)

[Asymmetric carbon](#)

[Atherogenesis](#)

[ATP](#)

[ATP as free energy currency](#)

[ATP energy summaries](#)

[ATP- \$\gamma\$ -S](#)

[Avidin](#)

[Axonemes](#)

[Azacytidine](#)

[Azaserine](#)

[Azide](#)

[AZT](#)

[Back to Main Index](#)

Index to Items Beginning with 'B'



[Back to Main Index](#)

[Bacitracin](#)

[Bacterial cell walls](#)

[Bacterial motility: rotating proteins](#)

[Bacteriorhodopsin](#)

[Band 4.1 protein](#)

[Base excision repair](#)

[Basic amino acids](#)

[β-Sheet](#)

[β-Turns](#)

[β-Alanine](#)

[β-Aspartate semialdehyde dehydrogenase](#)

[β-Aspartyl-phosphate](#)

[β-Carotene](#)

[β-Cyanoalanine](#)

[β-Hydroxybutyrate](#)

[β-Hydroxybutyrate dehydrogenase](#)

[β-Keto-ACP reductase](#)

[β-Keto-ACP synthase](#)

[β-Ketoacyl ACP](#)

[β-Mercaptoethanolamine](#)

[β-O-acetylserine](#)

[β-Oxidation of fatty acids](#)

[β-Ureidopropionase](#)

[β-Ureidopropionic acid](#)

[Bile acids](#)

[Bile salts](#)

[Bile salts and emulsion of fats](#)

[Bilirubin](#)

[Bilirubin diglucuronide](#)

Biliverdin

Biochemistry - An interdisciplinary science

Biochemistry as a biological science

Biochemistry as a chemical science

Biochemistry of neurotransmission

Biological fuel

Biological molecules

Biosynthesis and degradation

Biosynthesis of histidine

Biosynthesis of other polysaccharides

Biosynthesis of sphingolipids

Biosynthesis of thymine deoxyribonucleotides

Biotin

Bisphosphoglycerate and hemoglobin

Bisphosphoglycerate mutase

Blood clotting

Blood metabolism

Bohr effect

Bovine pancreatic trypsin inhibitor

Brain metabolism

Branching enzyme

Buffer calculations

Bundle sheath cells

[Back to Main Index](#)

Index to Items Beginning with 'C'



[Back to Main Index](#)

[C₄ cycle](#)

[Calmodulin](#)

[Calpains](#)

[Calvin cycle](#)

[Calvin cycle reactions](#)

[cAMP receptor protein \(CRP\)](#)

[cAMP-dependent protein kinase](#)

[Carbamoyl phosphate](#)

[Carbamoyl phosphate synthetase](#)

[Carbamoyl phosphate synthetase II](#)

[Carbohydrate metabolism and fatty acid synthesis](#)

[Carbon dioxide and hemoglobin](#)

[Carbon monoxide](#)

[Cardiolipin](#)

[Carnitine](#)

[Carnitine acyltransferase I](#)

[Carnitine acyltransferase II](#)

[Catabolism of other saccharides](#)

[Catalase](#)

[Catecholamines](#)

[Cathepsins](#)

[CDP](#)

[CDP-choline](#)

[CDP-choline: 1,2-diacylglycerol phosphocholine transferase](#)

[CDP-diacylglycerol](#)

[CDP-glucose](#)

[Cell cycle](#)

[Cellobiose](#)

[Cellular conditions for ATP hydrolysis](#)

Cellulase

Cellulose

Central pathways of energy metabolism

Ceramides

Cerebrosides

CF₀CF₁

Chain elongation of palmitate

Chaperonins

Chemiosmotic coupling

Chenodeoxycholate

Chitin

Chloramphenicol

Chlorophyll

Chlorophyll a

Chlorophyll b

Chloroplast

Chloroplast anatomy

Chloroplasts

Cholecalciferol

Cholesterol

Cholesterol biosynthesis

Cholesterol esters

Cholic acid (cholate)

Choline

Choline acetyltransferase

Choline kinase

Chondroitin sulfates

Chorismic acid

Chromatin

Chromatin remodeling

Chromatin structure and transcription

Chromosomes

Chylomicrons

cI repressor

Circular DNA and supercoiling

[Cis-aconitate](#)

[Citrate](#)

[Citrate lyase](#)

[Citrate shuttle](#)

[Citrate synthase](#)

[Citric acid cycle enzymes](#)

[Citric acid cycle intermediates](#)

[Citric acid cycle intermediates in amino acid metabolism](#)

[Citric acid cycle reactions](#)

[Citric acid cycle regulation](#)

[Citric acid cycle strategy](#)

[Citroyl-CoA](#)

[Citrulline](#)

[Classification of protein enzymes](#)

[Clathrate structure of water](#)

[Clathrin](#)

[Clonal selection theory](#)

[CMP](#)

[CMP-sialic acid](#)

[Coated pits](#)

[Codon](#)

[Coenzyme A](#)

[Coenzyme Q](#)

[Coenzymes](#)

[Coenzymes in nitrogen metabolism](#)

[Collagen](#)

[Collagen synthesis](#)

[Conformational isomers](#)

[Coniferyl alcohol](#)

[Control of eukaryotic translation](#)

[Control of fatty acid synthesis](#)

[Cordycepin](#)

[Cori cycle](#)

[Corticotropin Releasing Hormone \(CRH\)](#)

[Cortisol](#)

[Coulomb's law](#)

[Coupled reactions](#)

[Covalent modification of proteins](#)

[Covalent modifications to regulate enzyme activity](#)

[Covalent vs noncovalent bonds](#)

[Creatine](#)

[Creatine kinase](#)

[Creatine phosphate](#)

[Cro repressor](#)

[CTP](#)

[CTP synthetase](#)

[Cyanide](#)

[Cyclic amino acid](#)

[Cyclic AMP](#)

[Cyclic electron flow in photosynthesis](#)

[Cyclic GMP](#)

[Cycloheximide](#)

[Cystathionine](#)

[Cystathionine synthase](#)

[Cysteine](#)

[Cysteine metabolism](#)

[Cytidine](#)

[Cytidine diphosphate](#)

[Cytidine monophosphate](#)

[Cytidine triphosphate](#)

[Cytochrome b6f](#)

[Cytochrome oxidase](#)

[Cytochrome P-450](#)

[Cytochromes](#)

[Cytosine](#)

[Back to Main Index](#)

Index to Items Beginning with 'D'

[Back to Main Index](#)

[D-3-Hydroxyacyl-ACP](#)

[D-Alanine](#)

[D-Amino acids](#)

[D-Glutamic acid](#)

[dADP](#)

[dAMP](#)

[dATP](#)

[dCDP](#)

[dCMP](#)

[dCMP deaminase](#)

[dCTP](#)

[ddC \(2',3'-dideoxycytidine\)](#)

[ddI \(2',3'-dideoxyinosine\)](#)

[De novo pyrimidine nucleotide metabolism](#)

[De novo synthesis of purine nucleotides](#)

[Debranching enzyme](#)

[Debye-Huckel theory](#)

[Dehydrolipoamide transacetylase \(E2\)](#)

[\$\delta\$ -Aminolevulinic acid \(ALA\)](#)

[\$\delta\$ -Aminolevulinic Acid Synthetase \(ALA Synthetase\)](#)

[Deoxyadenosine](#)

[Deoxyadenosine diphosphate](#)

[Deoxyadenosine monophosphate](#)

[Deoxyadenosine triphosphate](#)

[Deoxycholate](#)

[Deoxycytidine](#)

[Deoxycytidine diphosphate](#)

[Deoxycytidine kinase](#)

[Deoxycytidine monophosphate](#)

Deoxycytidine triphosphate

Deoxyguanosine

Deoxyguanosine diphosphate

Deoxyguanosine kinase

Deoxyguanosine monophosphate

Deoxyguanosine triphosphate

Deoxypyrimidine kinase

Deoxyribose

Deoxyribose-5-phosphate

Deoxythymidine diphosphate

Deoxythymidine monophosphate

Deoxythymidine triphosphate

Deoxyuridine nucleotide metabolism

Deoxyuridine

Deoxyuridine diphosphate

Deoxyuridine monophosphate

Deoxyuridine triphosphate

Derivation of the hyperbolic oxygen binding curve of myoglobin

Derivatives of monosaccharides

Dermatan sulfates

dGDP

dGMP

dGTP

Diabetes

Diacylglycerol

Diacylglycerol lipase

Diacylglycerol-3-phosphate

Diastereomers

Dielectric constant

Dielectric medium

Diethylstilbestrol

Difference spectra

Digitoxin

Dihydrobiopterin

Dihydrofolate reductase

[Dihydrolipoamide dehydrogenase \(E3\)](#)

[Dihydroorotase](#)

[Dihydroorotate](#)

[Dihydrouracil](#)

[Dihydroxyacetone](#)

[Dihydroxyacetone phosphate](#)

[Dimethylallyl pyrophosphate](#)

[Dimethylsulfoxide reductase](#)

[Disaccharides](#)

[Disaccharides](#)

[Dispersion forces](#)

[DNA](#)

[DNA](#)

[DNA methylation](#)

[DNA Polymerase I \(*E. coli*\)](#)

[DNA Polymerase II \(*E. coli*\)](#)

[DNA Polymerase III \(*E. coli*\)](#)

[DNA polymerases \(*E. coli*\)](#)

[DNA replication complexes](#)

[DNA replication fidelity](#)

[DNA replication in linear genomes](#)

[DNA replication initiation](#)

[DNA replication overview](#)

[DNA replication proteins \(other\)](#)

[Dolichol](#)

[Dolichol phosphate](#)

[Dolichol phospho-glucose](#)

[Dolichol phospho-mannose](#)

[Dopa \(3,4-dihydroxyphenylalanine\)](#)

[Dopamine](#)

[Drug design](#)

[dTDP](#)

[dTMP](#)

[dTTP](#)

[dUDP](#)

[dUMP](#)

[dUTP](#)

[dUTPase](#)

[Dynamics of protein folding](#)

[Dynein](#)

[Back to Main Index](#)

Index to Items Beginning with 'E'

[Back to Main Index](#)

[Eadie Hofstee plot](#)

[Eicosanoid functions](#)

[Eicosanoids](#)

[Elastin](#)

[Electron acceptors](#)

[Electron transport](#)

[Endoplasmic reticulum](#)

[Energetics in muscular motion](#)

[Energy of interaction](#)

[Energy of light](#)

[Enolase](#)

[Enoyl-ACP reductase](#)

[Enoyl-CoA hydratase](#)

[Enoyl-CoA isomerase](#)

[Enthalpy](#)

[Enthalpy and the second law of thermodynamics](#)

[Enzyme inhibition](#)

[Enzyme roles](#)

[Epinephrine](#)

[Epinephrine action](#)

[Erythritol](#)

[Erythrocyte membranes](#)

[Erythromycin](#)

[Erythrose](#)

[Erythrose-4-phosphate](#)

[Erythrulose](#)

[Essential amino acids](#)

[Essential fatty acids](#)

[Ester phospholipids](#)

Estradiol

Estrogens

Ethanol

Ethanol metabolism and gluconeogenesis

Ethanolamine

Ethylene

Eukaryotic DNA and development

Eukaryotic DNA polymerases

Eukaryotic DNA replication

Eukaryotic mismatch repair

Eukaryotic transcriptional initiation/elongation

Eukaryotic transcription

Eukaryotic vs prokaryotic translation

Evolution of myoglobin/hemoglobin proteins

[Back to Main Index](#)

Index to Items Beginning with 'F'

[Back to Main Index](#)

[F₀F₁ complex](#)

[FA](#)

[Factor-dependent termination](#)

[Factor-independent termination of transcription](#)

[Factors contributing to large energy of hydrolysis of phosphate compounds](#)

[Factors determining secondary and tertiary structure](#)

[FAD](#)

[FADH₂](#)

[Familial hypercholesterolemia](#)

[Farnesyl pyrophosphate](#)

[Fat](#)

[Fat absorption and transport](#)

[Fats and energy storage](#)

[Fatty acid activation](#)

[Fatty acid biosynthesis strategy](#)

[Fatty acid desaturation](#)

[Fatty acid synthase](#)

[Fatty acids](#)

[Fatty acyl-CoA dehydrogenase](#)

[Fatty acyl-CoA desaturase](#)

[Fatty acyl-CoA ligase](#)

[FB](#)

[FdUMP \(5-Fluorodeoxyuridine monophosphate\)](#)

[Fenfluramine](#)

[Fermentation](#)

[Ferredoxin](#)

[Ferredoxin-NADP⁺-Oxidoreductase \(FNR\)](#)

[Fibrin](#)

Fibroin

Fibrous proteins

Fischer projection

Flagellin

Flavin mononucleotide (FMN)

Flavin mononucleotide, reduced (FMNH₂)

Fluoroacetate

Fluorocitrate

Foam cells

Folic acid

Foundations of modern biochemistry

Free energy and concentration

Free energy and useful work

Free energy change and the equilibrium constant

Free energy changes from oxidation/reduction

Fructokinase

Fructose

Fructose metabolism

Fructose-1,6-bisphosphatase

Fructose-1,6-bisphosphate

Fructose-1-phosphate

Fructose-2,6-bisphosphatase

Fructose-2,6-bisphosphate

Fructose-2,6-bisphosphate and gluconeogenesis regulation

Fructose-6-phosphate

Fucose

Fumarate

Fumarate hydratase (Fumarase)

Function of coenzymes

FX

[Back to Main Index](#)

Index to Items Beginning with 'G'



[Back to Main Index](#)

[G protein families and subunits](#)

[G proteins and signal transduction](#)

[G proteins in vision](#)

[Galactokinase](#)

[Galactosamine](#)

[Galactose](#)

[Galactose metabolism](#)

[Galactose operon](#)

[Galactose-1-phosphate](#)

[Galactosyltransferase](#)

[Galacturonic acid](#)

[\$\gamma\$ - Amino butyric acid](#)

[\$\gamma\$ - Carboxyglutamic Acid](#)

[Ganciclovir](#)

[Gangliosides](#)

[GDP](#)

[GDP-mannose](#)

[Gene amplification](#)

[Gene families](#)

[Gene rearrangements](#)

[Generating antibody diversity](#)

[Genes](#)

[Genetic code](#)

[Genetics review](#)

[Gentiobiose](#)

[Geranyl pyrophosphate](#)

[Globin gene expression in development](#)

[Globosides](#)

[Globular proteins](#)

[Glucagon](#)

[Glucagon action](#)

[Glucocorticoid hormones](#)

[Glucogen synthase D](#)

[Glucokinase](#)

[Gluconeogenesis](#)

[Gluconeogenesis and bodily needs for glucose](#)

[Gluconeogenesis and glycolysis regulation](#)

[Gluconeogenesis enzymes](#)

[Gluconeogenesis molecular intermediates](#)

[Gluconeogenesis precursors](#)

[Gluconeogenesis regulation](#)

[Glucosamine](#)

[Glucosamine-6-phosphate](#)

[Glucose](#)

[Glucose-1-phosphate](#)

[Glucose-6-phosphatase](#)

[Glucose-6-phosphate](#)

[Glucose-6-phosphate dehydrogenase](#)

[Glucose-alanine cycle](#)

[Glucuronic acid](#)

[Glutamate as a precursor to other amino acids](#)

[Glutamate dehydrogenase](#)

[Glutamate synthase](#)

[Glutamic Acid](#)

[Glutamic- \$\gamma\$ -semialdehyde](#)

[Glutaminase](#)

[Glutamine](#)

[Glutamine synthetase](#)

[Glutamine: fructose-6-phosphate amidotransferase](#)

[Glutaredoxin](#)

[Glutaryl-CoA](#)

[Glutathione](#)

[Glutathione metabolism](#)

[Glutathione peroxidase](#)

[Glutathione reductase](#)

[Glyceraldehyde](#)

[Glyceraldehyde-3-phosphate](#)

[Glyceraldehyde-3-phosphate dehydrogenase](#)

[Glycerol](#)

[Glycerol kinase](#)

[Glycerol-3-phosphate dehydrogenase](#)

[Glycerol-3-phosphate](#)

[Glycerol-3-phosphate](#)

[Glycerol-3-phosphate dehydrogenase](#)

[Glycerophospholipid image map](#)

[Glycerophospholipid metabolism in eukaryotes](#)

[Glycerophospholipid synthesis in bacteria](#)

[Glycerophospholipids](#)

[Glycine](#)

[Glycine Betaine](#)

[Glycine metabolism](#)

[Glycocholate](#)

[Glycoconjugate biosynthesis](#)

[Glycogen](#)

[Glycogen](#)

[Glycogen biosynthesis](#)

[Glycogen breakdown](#)

[Glycogen breakdown regulation](#)

[Glycogen metabolism diseases](#)

[Glycogen phosphorylase](#)

[Glycogen phosphorylase a](#)

[Glycogen phosphorylase b](#)

[Glycogen phosphorylase b kinase](#)

[Glycogen synthase](#)

[Glycogen synthase I](#)

[Glycolysis](#)

[Glycolysis molecular intermediates](#)

[Glycolysis reactions/energies](#)

[Glycolysis regulation](#)

[Glycolysis strategy](#)

[Glycophorins](#)

[Glycoproteins](#)

[Glycosaminoglycans](#)

[Glycosides and glycosidic bonds](#)

[Glycosphingolipids](#)

[Glyoxylate](#)

[Glyoxylate cycle](#)

[Glyoxylate cycle enzymes](#)

[Glyoxylate cycle intermediates](#)

[Glyphosate](#)

[GMP](#)

[Golgi Apparatus](#)

[Gout](#)

[Grana](#)

[GTP](#)

[Guanidinoacetate](#)

[Guanine](#)

[Guanine deaminase](#)

[Guanosine](#)

[Guanosine diphosphate](#)

[Guanosine monophosphate](#)

[Guanosine triphosphate](#)

[Guanosine-3',5'-tetrphosphate](#)

[Guanylate cyclase](#)

[Guanylate kinase](#)

[Back to Main Index](#)

Index to Items Beginning with 'H'



[Back to Main Index](#)

[Haworth projection](#)

[HDLs \(high density lipoprotein complexes\)](#)

[Headpieces](#)

[Heart metabolism](#)

[Heme](#)

[Heme a](#)

[Heme metabolism](#)

[Hemoglobin](#)

[Hemoglobin allostery](#)

[Hemoglobin variants](#)

[Henderson-Hasselbalch equation](#)

[Heparin](#)

[Hexokinase](#)

[Higher order chromatin structure](#)

[Hill plots and cooperativity](#)

[Histidine](#)

[Histidine metabolism](#)

[Histones](#)

[History of DNA](#)

[HIV](#)

[HMG-CoA](#)

[HMG-CoA ligase](#)

[HMG-CoA reductase](#)

[HMG-CoA reductase](#)

[HMG-CoA synthase](#)

[Homocysteine](#)

[Homogentisic acid](#)

[Homologous recombination](#)

[Homoserine](#)

[Hormonal regulation of fuel metabolism](#)

[Hormone action](#)

[Hormone hierarchy of action](#)

[Hormone mechanisms of action](#)

[Hormone receptors](#)

[Hormones](#)

[How catalysts work](#)

[Hyaluronic acid](#)

[Hydrogen bonds](#)

[Hydrolysis vs phosphorolysis](#)

[Hydrophilic](#)

[Hydrophobic](#)

[Hydropyrimidine hydratase](#)

[Hydroxylated or sulfur amino acids](#)

[Hydroxylysine](#)

[Hydroxyproline](#)

[Hydroxyurea](#)

[Hypoxanthine](#)

[Hypoxanthine-guanine phosphoribosyltransferase \(HGPRT\)](#)

[Back to Main Index](#)

Index to Items Beginning with 'I'



[Back to Main Index](#)

[Ibuprofen](#)

[IDLs \(intermediate density lipoprotein complexes\)](#)

[Idose](#)

[Immune response](#)

[Immunodeficiency and defective purine catabolism](#)

[Immunoglobulins](#)

[IMP \(inosine monophosphate\)](#)

[IMP dehydrogenase](#)

[Importance of metastability](#)

[Important differences between \$\Delta G_0\$ and \$\Delta G_0'\$](#)

[Important points about \$\Delta G\$](#)

[Indole-3-acetic acid](#)

[Induced dipoles](#)

[Induced fit model](#)

[Inhibitors and artificial electron acceptors](#)

[Initiation and elongation](#)

[Initiation of DNA replication](#)

[Inosine](#)

[Inositol 1,4,5-triphosphate \(InsP3\)](#)

[Inositol Hexasphosphate](#)

[Insulin](#)

[Insulin action](#)

[Insulin receptor](#)

[Integrity of mitochondrial membranes](#)

[Interactions with promoters](#)

[Interleukin 2](#)

[Internal energy](#)

[Internal ribosomal structure](#)

[Interplay of enthalpy and entropy](#)

[Intracellular transport of materials](#)

[Introns](#)

[Ionic equilibria and pH](#)

[IPTG](#)

[Isocitrate](#)

[Isocitrate dehydrogenase](#)

[Isocitrate lyase](#)

[Isoleucine](#)

[Isoleucine metabolism](#)

[Isopentenyl pyrophosphate](#)

[Isopropylthiogalactoside \(IPTG\)](#)

[Isoproterenol](#)

[Back to Main Index](#)

Index to Items Beginning with 'J'



[Back to Main Index](#)

Index to Items Beginning with 'K'



[Back to Main Index](#)

[Ka and pKa](#)

[Keratan sulfate](#)

[Keratins](#)

[Ketogenesis](#)

[Ketone bodies](#)

[Kinase cascade](#)

[Kinesin](#)

[KM, kcat, and kcat/KM](#)

Index to Items Beginning with 'L'

[Back to Main Index](#)

[L-3-Hydroxyacyl-S-CoA](#)

[L-amino acid oxidase](#)

[Lac repressor](#)

[Lactase](#)

[Lactate](#)

[Lactate dehydrogenase isoenzymes](#)

[Lactonase](#)

[Lactose](#)

[Lactose fermentation](#)

[Lactose intolerance](#)

[Lactose operon regulation](#)

[Lactose synthase](#)

[λ- Phage biology](#)

[Lanosterol](#)

[Lactate dehydrogenase](#)

[LDL receptor](#)

[LDLs \(low density lipoprotein complexes\)](#)

[Lecithin cholesterol acyl transferase](#)

[Leptin](#)

[Lesch-Nyhan syndrome](#)

[Leucine](#)

[Leucine metabolism](#)

[Leukotrienes](#)

[Light absorbing pigments](#)

[Light gathering structures](#)

[Light harvesting complexes](#)

[Lineweaver Burk plots](#)

[Linking Number](#)

[Linoleic acid](#)

[Linolenic acid](#)

[Lipid complexes in fat transport](#)

[Lipid-soluble vitamins](#)

[Lipids](#)

[Lipids in biological membranes](#)

[Lipoamide](#)

[Lipoic acid](#)

[Lipoic acid \(lipoamide\) as acyl carrier and electron carrier](#)

[Lipoprotein complexes](#)

[Lipoprotein lipase](#)

[Liver metabolism](#)

[Lovastatin](#)

[Lung surfactant](#)

[Lycopene](#)

[Lysine](#)

[Lysine metabolism](#)

[Lysolecithin](#)

[Lysosomes](#)

[Back to Main Index](#)

Index to Items Beginning with 'M'



[Back to Main Index](#)

[Macroions](#)

[Maintaining blood glucose levels](#)

[Malate](#)

[Malate dehydrogenase](#)

[Malate synthase](#)

[Malic enzyme](#)

[Malonate](#)

[Malonyl-ACP](#)

[Malonyl-CoA](#)

[Malonyl-CoA-ACP transacylase](#)

[Maltase](#)

[Maltose](#)

[Mannitol](#)

[Mannose](#)

[Mannose-6-phosphate](#)

[Mannuronic acid](#)

[Mechanism of activating glycogen breakdown](#)

[Mechanisms of protein mutation](#)

[Melatonin](#)

[Membrane asymmetry](#)

[Membrane fluidity](#)

[Membrane proteins](#)

[Messenger RNA](#)

[Metabolic control mechanisms](#)

[Metabolic melodies](#)

[Metabolic nitrogen balance](#)

[Metabolism of aromatic amino acids and histidine](#)

[Metabolism of ornithine and arginine](#)

[Metabolism of serine, glycine, and threonine](#)

Metabolism of sulfur-containing amino acids

Metabolism of valine, leucine, isoleucine, and lysine

Metalloenzymes

Methionine

Methionine metabolism

Methotrexate

Methylmalonyl-CoA

Methylmalonyl-CoA mutase

Methylmalonyl-CoA epimerase

Mevalonic acid

Michaelis-Menten kinetics

Microbial cell wall polysaccharides -peptidoglycans

Microtubule systems

Mineralocorticoids

Mitochondria

Mitochondrial structure and function

Models of allosteric activity

Modified amino acids in proteins

Molecular control of the cell cycle

Molecular engineering

Molecular structure and properties of lipids

Monoacylglycerol

Monoacylglycerol lipase

Monosaccharide nomenclature

Monosaccharides

Morphine

Motions of cilia and flagella

Motions within globular protein molecules

mRNA turnover

Multisubstrate reactions

Multisubunit proteins and their interactions

Muramic acid

Muscle metabolism

Mutarotation

Mutation suppression

[Myoglobin](#)

[Myristic Acid \(Myristate\)](#)

[Back to Main Index](#)

Index to Items Beginning with 'N'



[Back to Main Index](#)

[N-10-Formyltetrahydrofolate \(10-formyl-THF\)](#)

[N-4-Methylcytosine](#)

[N-6-Methyladenine \(mA\)](#)

[N-Acetyl-D-galactosamine sulfate](#)

[N-Acetyl-muramic acid](#)

[N-Acetyl-neuraminic Acid](#)

[N-acetylgalactosamine](#)

[N-acetylglucosamine](#)

[N-acetyllactosamine](#)

[N-carbamoyl-L-aspartate \(CAA\)](#)

[NAD+](#)

[NAD+/NADH balance](#)

[NADH](#)

[NADP+](#)

[NADPH](#)

[Nalidixic acid](#)

[Neurotransmission](#)

[Neurotransmitters and biological receptors](#)

[Neurotransmitters and their receptors](#)

[Nexin](#)

[Nicotine](#)

[Nitrate reductase](#)

[Nitrate utilization](#)

[Nitric Oxide](#)

[Nitric oxide actions](#)

[Nitric oxide synthase](#)

[Nitrite reductase](#)

[Nitrogen cycle](#)

[Nitrogen fixation](#)

[**Nitrogenase \(component I\)**](#)

[**Nitrogenase reductase**](#)

[**Nonmuscle actin and myosin**](#)

[**Norepinephrine**](#)

[**Norethynodrel**](#)

[**NSAIDs**](#)

[**Nucleic acid sequences**](#)

[**Nucleic acids**](#)

[**Nucleoside diphosphokinase \(NDPK\)**](#)

[**Nucleoside kinases**](#)

[**Nucleosides**](#)

[**Nucleosides and nucleotide naming**](#)

[**Nucleosomes**](#)

[**Nucleotidases**](#)

[**Nucleotide analogs in medicine**](#)

[**Nucleotide analogs in selection**](#)

[**Nucleotide excision repair**](#)

[**Nucleotide metabolism pathways**](#)

[**Nucleotide properties**](#)

[**Nucleotide salvage synthesis**](#)

[**Nucleotides**](#)

[**Nucleus**](#)

[**Back to Main Index**](#)

Index to Items Beginning with 'O'



[Back to Main Index](#)

[O-Phosphoserine](#)

[O2-Methylguanosine](#)

[O6-alkylguanine](#)

[O6-alkylguanine alkytransferase](#)

[Obesity biochemistry](#)

[Odd-numbered fatty acid oxidation](#)

[Oleic acid](#)

[Oligosaccharides](#)

[Oligosaccharides and polysaccharides as cell markers](#)

[ω-3-fatty acids](#)

[Oncogenes](#)

[Oncogenes and cell signaling](#)

[Oncogenes in human tumors](#)

[Ornithine](#)

[Ornithine metabolism](#)

[Ornithine transcarbamoylase](#)

[Orotic acid \(orotate\)](#)

[Other high energy nucleotides](#)

[Ouabain](#)

[Oxaloacetate](#)

[Oxidases and oxygenases](#)

[Oxidation and energy generation](#)

[Oxidation as a metabolic energy source](#)

[Oxidation/reduction](#)

[Oxidative phosphorylation](#)

[Oxygen binding by heme proteins](#)

[Oxygen binding by hemoglobin](#)

[Oxygen binding by myoglobin](#)

[Oxygen metabolism and human disease](#)

[Oxytetracycline](#)

[Back to Main Index](#)

Index to Items Beginning with 'P'



[Back to Main Index](#)

[p-Aminobenzoic acid](#)

[p-Hydroxybenzoic Acid](#)

[P/O ratio](#)

[p53](#)

[Pactamycin](#)

[Palindromes](#)

[Palmitate synthesis from acetyl-CoA](#)

[Palmitic acid](#)

[Palmitoleic acid](#)

[Palmitoyl-CoA](#)

[Pancreas anatomy](#)

[Pancreatic lipase](#)

[Pantothenic Acid](#)

[PAPS \(3'-phosphoadenosine-5'-phosphosulfate\)](#)

[Passive transport mechanisms](#)

[Passive vs active transport](#)

[Penicillin](#)

[Pentose phosphate pathway](#)

[Pentose phosphate pathway enzymes](#)

[Pentose phosphate pathway intermediates](#)

[PEP carboxykinase](#)

[PEP carboxylase](#)

[Peptide bond structure and stability](#)

[Peptide bonds](#)

[Peptide hormone synthesis](#)

[Peptidoglycans](#)

[Permanent dipoles](#)

[Peroxisomal oxidation of fatty acids](#)

[PGH synthase \(prostaglandin H synthase\)](#)

Phenylalanine

Phenylalanine hydroxylase

Phenylalanine metabolism

Pheophytin

Phosphatidic acid

Phosphatidyl-glycerol-3-phosphate

Phosphatidylcholine

Phosphatidylglycerol

Phosphatidylinositol

Phosphatidylinositol 4,5-bisphosphate (PIP2)

Phosphatidylserine

Phosphocholine

Phosphodiester bonds

Phosphoenolpyruvate

Phosphofructokinase

Phosphofructokinase 2

Phosphoglucoisomerase

Phosphoglucomutase

Phosphoglycerate kinase

Phosphoglycerate mutase

Phosphoglycolate

Phospholipase a2

Phospholipase C

Phospholipases

Phospholipid bilayer

Phosphopentose epimerase

Phosphopentose isomerase

Phosphoprotein phosphatase I (PP-I)

Phosphoprotein phosphatase inhibitor (PI-1)

Phosphoribosyl Pyrophosphate (PRPP)

Phosphoribosyl transferases

Phosphorolysis

Phosphorylation mechanisms

Phosphatidylethanolamine

Photochemistry

[Photophosphorylation](#)

[Photoreactivation](#)

[Photoreception chemistry](#)

[Photorespiration](#)

[Photosynthesis - basic process](#)

[Photosynthesis reaction efficiency](#)

[Photosynthesis regulation](#)

[Photosystem I](#)

[Photosystem II](#)

[Photosystem summary](#)

[Phylloquinone A1](#)

[Phytanic acid](#)

[pI](#)

[Plant hormones](#)

[Plasmalogens](#)

[Plastocyanin](#)

[Plastoquinone QA](#)

[Plastoquinone QB](#)

[Plastoquinone QH2](#)

[Plastoquinones](#)

[Polyamines](#)

[Polyampholytes](#)

[Polyelectrolytes](#)

[Polyketide synthesis](#)

[Polyketides](#)

[Polynucleotide sequences](#)

[Polypeptide chain folding](#)

[Polypeptide sequence](#)

[Polypeptides](#)

[Polysaccharides](#)

[Porphobilinogen](#)

[Porphyrin and heme metabolism](#)

[Porphyrinogen](#)

[Postreplication repair](#)

[Posttranscriptional processing of rRNA and tRNA](#)

Posttranslational addition of lipids to proteins

Posttranslational modification of proteins

Prediction of secondary and tertiary protein structure

Pregnenolone

Presqualene pyrophosphate

Primary, secondary and tertiary structure of nucleic acids

Prions and protein folding

Processing of mRNA

Procollagen proline hydroxylase

Progesterone

Progestins

Programmed destruction of proteins

Prokaryotic mismatch repair

Prokaryotic translation regulation

Proline

Promoter organization

Propionyl-CoA

Propionyl-CoA carboxylase

Propranolol

Prostaglandin A

Prostaglandin biosynthesis

Prostaglandin E

Prostaglandin E₂

Prostaglandin F

Prostaglandin F₂

Prostaglandin H

Prostaglandin H₂

Prostaglandin I₂

Prostaglandins

Proteasomes

Protein kinase C

Protein targeting

Protein turnover

Proteins

Proteins of recombination

[Proteoglycans](#)

[Protoporphyrin IX](#)

[PRPP](#)

[PRPP amidotransferase](#)

[PRPP synthetase](#)

[PRPP's importance](#)

[Pterioic Acid](#)

[Purine degradation](#)

[Purines](#)

[Puromycin](#)

[Putrescine](#)

[Pyridoxal phosphate](#)

[Pyrimidine catabolism](#)

[Pyrimidine dimers](#)

[Pyrimidines](#)

[Pyruvate](#)

[Pyruvate carboxylase](#)

[Pyruvate decarboxylase](#)

[Pyruvate decarboxylase \(E1\)](#)

[Pyruvate dehydrogenase complex](#)

[Pyruvate dehydrogenase complex regulation](#)

[Pyruvate dehydrogenase kinase](#)

[Pyruvate dehydrogenase](#)

[Pyruvate dehydrogenase phosphatase](#)

[Pyruvate kinase](#)

[Pyruvate kinase isoenzyme regulation](#)

[Pyruvate kinase regulation](#)

[Pyruvate oxidation](#)

[Pyruvate/lactate/ethanol metabolism](#)

[Back to Main Index](#)

Index to Items Beginning with 'Q'



[Back to Main Index](#)

Index to Items Beginning with 'R'



[Back to Main Index](#)

[Ramachandran plots](#)

[Ras](#)

[Reaction center \(photosynthesis\)](#)

[Reaction order](#)

[Reactive oxygen](#)

[RecA](#)

[RecA/SOS response](#)

[Receptor-mediated endocytosis](#)

[Receptors with protein kinase activity](#)

[Reciprocal regulation](#)

[Reciprocal regulation of glycogen biosynthesis and mobilization](#)

[Recombination](#)

[Recombinational repair](#)

[Reconstitution](#)

[Redistribution of phospholipid fatty acids](#)

[Regulation of enzyme activity](#)

[Regulation of ribonucleotide reductase](#)

[Relationship of gluconeogenesis to glycolysis](#)

[Relationship of glycolysis to other metabolic pathways](#)

[Repetitive sequences](#)

[Replication fork](#)

[Replication of linear genomes](#)

[Respiration](#)

[Respiratory control](#)

[Response to starvation](#)

[Resting potential](#)

[Restriction endonucleases \(Type I\)](#)

[Restriction endonucleases \(Type II\)](#)

[Restriction endonucleases \(Type III\)](#)

Restriction enzyme types

Restriction-modification

Retinal

Retinoic acid

Retrovirus replication

Retrovirus transposition

Reverse transcriptase

Rhodopsin

Riboflavin

Ribonucleotide reductase

Ribonucleotide reductase and deoxyribonucleotide biosynthesis

Ribose

Ribose-1-phosphate

Ribose-5-phosphate

Ribosomal RNA

Ribosomes

Ribozymes

Ribulose biphosphate carboxylase-oxygenase (RUBISCO)

Ribulose-1,5-bisphosphate

Ribulose-5-phosphate kinase

Ribulose=5-phosphate

Rifampicin

RNA

RNA polymerase I

RNA polymerase I transcription

RNA polymerase II

RNA polymerase II transcription

RNA polymerase III

RNA polymerase III transcription

RNA polymerases

RNA viruses

Role of calcium in contraction

Roles of hemoglobin and myoglobin

Rotenone

RU-486

[Back to Main Index](#)

Index to Items Beginning with 'S'



[Back to Main Index](#)

[S-Adenosylhomocysteine](#)

[S-Adenosylmethionine and biological methylation](#)

[S-Adenosylmethionine](#)

[Saccharides](#)

[Salting in/salting out](#)

[Salvage routes to deoxyribonucleotide synthesis](#)

[Sarcoplasmic reticulum](#)

[Sarcosine](#)

[Scavenger receptor](#)

[Second messenger systems](#)

[Secondary structure - general](#)

[Secondary structure - specific examples](#)

[Secondary structure - terms](#)

[Sedoheptulose-1,7-bisphosphatase](#)

[Sedoheptulose-1,7-bisphosphate](#)

[Sedoheptulose-7-phosphate](#)

[Selenocysteine](#)

[Semiconservative DNA replication](#)

[Serine](#)

[Serine metabolism](#)

[Serine protease catalysis](#)

[Serotonin](#)

[SGOT \(serum glutamate-oxaloacetate transaminase\)](#)

[SGPT \(glutamate-pyruvate transaminase\)](#)

[Shuttling electron carriers into the mitochondrion](#)

[Sialic acid](#)

[Signal transduction agonists and antagonists](#)

[Siroheme](#)

[Site-specific recombination](#)

Size of the eukaryotic genome

Sliding filament model

Sodium-potassium pump

Solubility and isoelectric point (pI)

Sorbitol

SOS regulon

Spectrin

Spermidine

Spermine

Sphinganine

Sphingolipids

Sphingolipids and disease

Sphingomyelin

Sphingosine

Squalene

Stability of nucleic acid secondary and tertiary structure

Standard reduction potential

Starch

Stearic acid

Stereochemistry

Stereospecificity of aconitase

Steroid and thyroid hormones--intracellular receptors

Steroid hormone synthesis

Steroid hormones

Steroid metabolism

Steroids.

Stop codons

Stored fat mobilization

Streptomycin

Stringent response

Stroma

Structural polysaccharides

Structure and properties of water

Structure of B-DNA

Structure of cro and cI repressors

[Structure of eukaryotic genes](#)

[Structure of muscle](#)

[Structure of prokaryotic mRNAs](#)

[Structure of RNA polymerase](#)

[Structure of tRNAs](#)

[Substrate level phosphorylation](#)

[Succinate](#)

[Succinate dehydrogenase](#)

[Succinyl-CoA](#)

[Succinyl-CoA synthetase](#)

[Sucrase](#)

[Sucrose](#)

[Sucrose phosphorylase](#)

[Sugar ring structures](#)

[Sugars](#)

[Suicide inhibitor](#)

[Supercoiling](#)

[Superoxide dismutase](#)

[Systems for studying metabolism](#)

[Back to Main Index](#)

Index to Items Beginning with 'T'



[Back to Main Index](#)

[T cells and the cellular response](#)

[Talose](#)

[Tamoxifen](#)

[Taurine](#)

[Taurocholate](#)

[Testosterone](#)

[Tethahydrofolate coenzymes](#)

[Tetracycline](#)

[Tetrahydrobiopterin](#)

[Thalassemas](#)

[Thermodynamics and transport across membranes](#)

[Thermodynamics of protein folding](#)

[Thiamine](#)

[Thiamine pyrophosphate](#)

[Thiamine pyrophosphate and decarboxylations](#)

[Thioester bond energy](#)

[Thiolase](#)

[Thioredoxin](#)

[Threonine](#)

[Threonine aldolase](#)

[Threonine metabolism](#)

[Thrombin](#)

[Thromboxane A₂](#)

[Thromboxane B₂](#)

[Thromboxanes](#)

[Thylakoid lumen](#)

[Thylakoid membrane](#)

[Thymidine](#)

[Thymidine kinase](#)

Thymidylate synthase

Thymine

Thymine dimers

Thymine glycol

Thyroglobulin

Thyroxine

Topoisomerases

Trans- Δ -2-enoyl-ACP

Trans- Δ -2-enoyl-CoA

Transaldolase

Transaminases

Transamination in amino acid metabolism

Transcription

Transcription background

Transcription factor binding domains

Transcription regulation in λ phage)

Transcription termination

Transducin

Transfer RNAs

Transition states and reaction rates

Transketolase

Translation

Translation overview

Translation rates and energetics

Translation termination

Translational elongation

Translational initiation

Translocases

Transport mechanisms

Transposable elements (Class I)

Transposable elements (Class II)

Transposable elements (Class III)

Transposable genetic elements

Tranverse Tubules

Trehalose

[Triacylglycerol lipase](#)

[Triacylglycerol synthesis](#)

[Trifluorocarbonylcyanide phenylhydrozone](#)

[Triiodothyronine](#)

[Trimethoprim](#)

[Triose phosphate isomerase](#)

[Triose phosphate isomerase catalysis](#)

[Tropomyosin](#)

[Troponin](#)

[trp operon regulation](#)

[Tryptophan](#)

[Tryptophan metabolism](#)

[Tryptophan synthase](#)

[Tubulin](#)

[Tunicamycin](#)

[Turnover number](#)

[Twist](#)

[Types and consequences of DNA damage](#)

[Tyrosine](#)

[Tyrosine kinase](#)

[Tyrosine metabolism](#)

[Back to Main Index](#)

Index to Items Beginning with 'U'



[Back to Main Index](#)

[UAA](#)

[UAG](#)

[Ubiquitin](#)

[UDP](#)

[UDP-galactose](#)

[UDP-galactose](#)

[UDP-glucose](#)

[UDP-glucose pyrophosphorylase](#)

[UDP-glucose- \$\alpha\$ -D-galactose-1-phosphate uridylyltransferase](#)

[UDP-glucose-4-epimerase](#)

[UDP-glucuronate](#)

[UDP-N-acetylgalactosamine](#)

[UDP-N-acetylglucosamine](#)

[UDP-N-acetylmuramic acid](#)

[UDP-N-acetylmuramyl pentapeptide](#)

[UGA](#)

[UMP](#)

[Uncoupling electron transport and oxidative phosphorylation](#)

[Undecaprenol phosphate](#)

[Unsaturated fatty acid oxidation](#)

[Uracil](#)

[Uracil-DNA N-glycosylase](#)

[Urea](#)

[Urea cycle](#)

[Uric acid](#)

[Uric acid excess in purine degradation](#)

[Uridine](#)

[Uridine diphosphate](#)

[Uridine monophosphate](#)

Uridine triphosphate

Uridylyl transferase

Uronic Acids

Uroporphyrinogen I

Uroporphyrinogen III

Uses of biochemistry

Utilization of ammonia

UTP

Index to Items Beginning with 'V'



[Back to Main Index](#)

[Valine](#)

[Valine metabolism](#)

[Valinomycin](#)

[van der Waals radius](#)

[Vancomycin](#)

[Viral and cellular oncogenes](#)

[Virus-directed alterations of nucleotide metabolism](#)

[Viruses](#)

[Vitamin A](#)

[Vitamin B12](#)

[Vitamin C](#)

[Vitamin D](#)

[Vitamin E](#)

[Vitamin K](#)

[Vitamin K1](#)

[Vitamin K2](#)

[Vitamins](#)

[VLDLs \(very low density lipoprotein complexes\)](#)

Index to Items Beginning with 'W'



[Writhe](#)

[Back to Main Index](#)

Index to Items Beginning with 'X'



[Back to Main Index](#)

[Xanthine](#)

[Xanthine oxidase](#)

[Xanthosine monophosphate \(XMP\)](#)

[XMP](#)

[Xylose](#)

[Xylulose-5-phosphate](#)

Index to Items Beginning with 'Y'



[Back to Main Index](#)

Index to Items Beginning with 'Z'



[Back to Main Index](#)

[Zwitterions](#)

[Zymogens](#)

- **Overview** of this product and its contents
- Minimum computer system **requirements** for successfully running this software. In addition to basic computer system requirements, this information also covers enabling Java (necessary to run the quizzes in the *Quizzing* section), and checking/ changing your computer's video display resolution so that you can view the contents of the site with less scrolling.
- Information on how to contact us for technical support (immediately below this bulleted list)
- **Troubleshooting** note for Macintosh users who are having a serious graphical display problem when operating in the *Quizzing* section of this software while using the Internet Explorer browser.

Contacting Us for Technical Support

If you have questions that haven't been answered by any of the links above, Addison Wesley Longman would like to address your questions through our technical support division:

Pearson Education Technology Support:

telephone: 800-677-6337

fax: 847-486-2595

email: techsprt@awl.com

web site: <http://techsupport.awl.com>

Troubleshooting Note for Macintosh Internet Explorer Users Experiencing Graphical Display Problems in the *Quizzing* Section of This Software

Some Macintosh Internet Explorer users have reported serious graphical display problems on their monitors while in the *Quizzing* section of this software. These problems are similar to the image shown below.

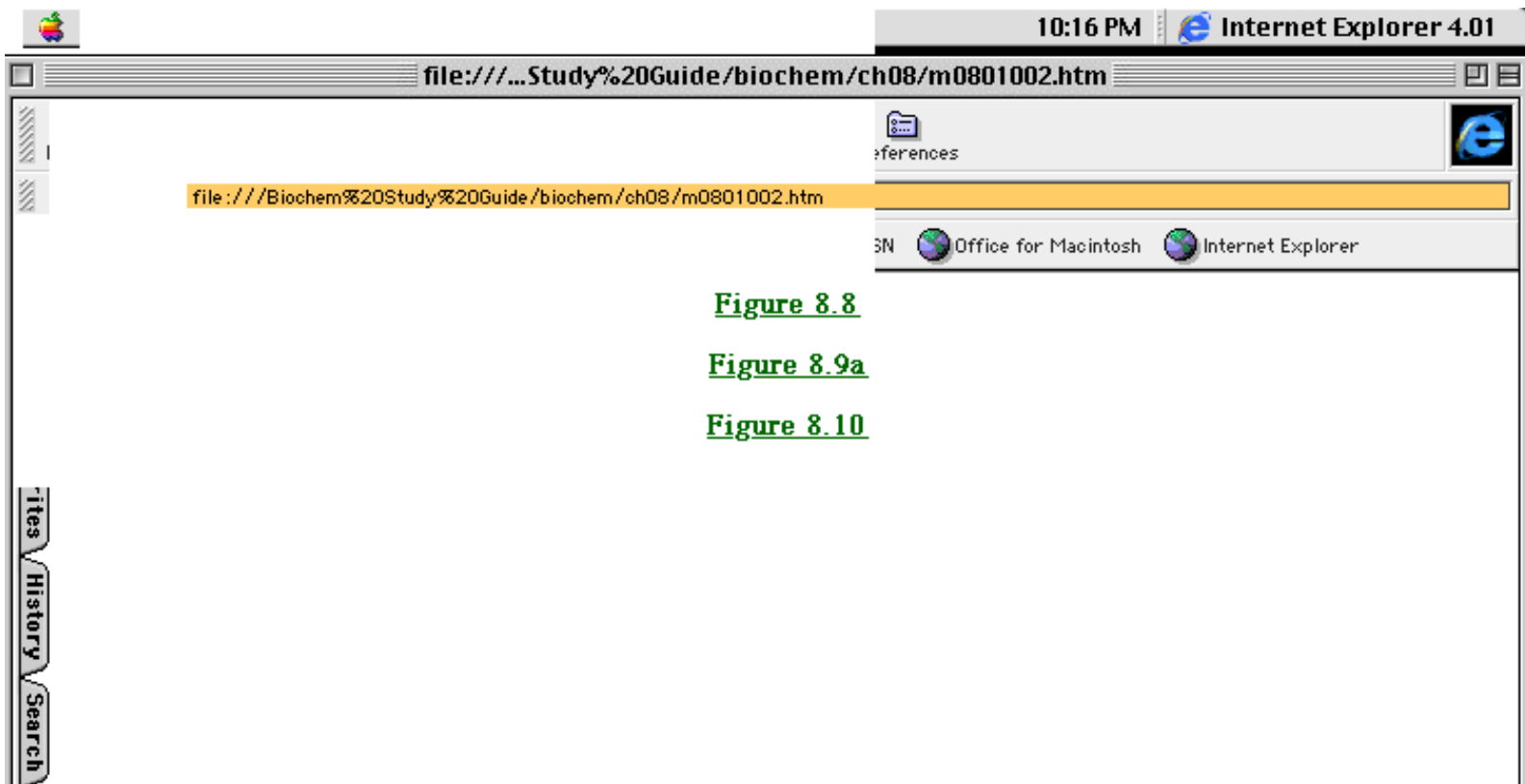

[Figure 8.8](#)

[Figure 8.9a](#)

[Figure 8.10](#)



Such a graphical display problem occurs because of an incompatibility between the quizzing exercises and older versions of the Macintosh Runtime for Java (which is a piece of software that allows Internet Explorer to view Java applets such as the *Quizzing* exercises). To resolve this problem:

1. Restart your computer system.
2. With the *Biochemistry 3/e Electronic Study Guide* CD-ROM in your CD-ROM drive, click on the "Install Biochem Study Guide" icon on the CD to launch the product installer (it won't be a problem that you have already done this in the past).
3. As part of the installation process, you will choose the "Microsoft" button to designate that you intend to use the Internet Explorer browser to run this product. After you have clicked "Microsoft," an "Installation Successful" dialog box will appear and will give you the option to install a compatible version of the Macintosh Runtime for Java (version 2.1.4). Choose this option. Version 2.1.4 of Macintosh Runtime for Java will then install on your computer system and you should not encounter the graphics display problem again.

chapter twenty-seven

outline | concepts
terminology | quizzing

1 2 3 4
5 6 7 8
9 10 11 12
13 14 15 16
17 18 19 20
21 22 23 24
25 26 27 28

help | index

Outline

Introduction ([Figure 5.19](#), [Figure 5.20](#))

An [Overview of Translation](#) ([Figure 4.20](#))

The [Genetic Code](#)

How the Code was Deciphered ([Figure 27.1](#), [Figure 27.2](#))

Features of the Code ([Figure 27.3](#), [Table 27.1](#), [Figure 27.4](#), [Table 27.2](#), [Figure 22.4](#))

The Major Participants in Translation: mRNA, tRNA, and Ribosomes

[Structure of Prokaryotic mRNAs](#) ([Figure 27.5](#), [Table 27.3](#))

Transfer RNA [Structure](#) ([Figure 27.6](#), [Figure 27.7](#), [Figure 4.20](#), [Figure 27.9](#))

Coupling of tRNAs to Amino Acids: Formation of Aminoacylated tRNAs ([Figure 27.10](#), [Figure 27.11](#))

The [Ribosome](#) ([Figure 27.13](#), [Figure 27.15](#), [Figure 27.16](#), [Figure 27.18](#), [Figure 27.19](#))

[Internal Structure of the Ribosome](#) ([Figure 27.25](#))

The Mechanisms of Translation ([Table 27.4](#))

[Initiation](#) ([Figure 27.20](#), [Figure 27.21](#))

[Elongation](#) ([Figure 27.22](#), [Figure 27.23](#))

[Termination](#) ([Figure 27.26](#))

[Suppression of Mutations](#) ([Figure 27.27](#), [Figure 27.31](#))

The [Inhibition](#) of Translation by Antibiotics ([Figure 27.28](#))

[Rates and Energetics of Translation](#)

The Final Stages in Protein Synthesis: Folding and Covalent Modification

[Chain Folding](#)

[Covalent Modification](#) ([Table 27.5](#), [Figure 27.30](#))

The [Regulation](#) of Protein Synthesis in Prokaryotes ([Figure 27.31](#), [Figure 27.32](#), [Figure 27.33](#))

chapter twenty-six

outline | concepts
terminology | quizzing

1	2	3	4
5	6	7	8
9	10	11	12
13	14	15	16
17	18	19	20
21	22	23	24
25	26	27	28

help | index

Outline

Introduction ([Figure 26.1](#))

DNA as the Template for RNA Synthesis

The Predicted Existence of Messenger RNA ([Figure 26.2](#))

T2 Bacteriophage and the Demonstration of Messenger RNA ([Figure 26.3](#))

RNA Dynamics in Uninfected Cells

Enzymology of RNA Synthesis: RNA Polymerase (Item [#1](#), p. 960, [#2](#))

Biological Role of [RNA Polymerase](#) ([Figure 26.4](#))

[Structure of RNA Polymerase](#) ([Table 26.1](#))

Mechanism of Transcription

Initiation of Transcription: [Interactions with Promoters](#) ([Figure 26.6](#))

[Initiation and Elongation](#): Incorporation of Ribonucleotides ([Figure 26.8](#))

Punctuation of Transcription: Promoter Recognition ([Figure 26.11](#), [Figure 26.12](#), [Figure 26.14](#))

Punctuation of Transcription: [Termination](#) ([Figure 26.15](#))

[Factor-Dependent](#) Termination ([Figure 26.16](#))

Regulation of Transcription

The Lactose Operon: Early Evidence for Transcriptional Control of Gene Expression

Regulation in the [Lactose Operon](#) ([Figure 26.17](#), [Figure 26.18](#))

Isolation and Properties of [Repressor](#)

The Repressor Binding Site ([Figure 26.10](#), [Figure 26.19](#))

Regulation of the lac Operon by Glucose: A Positive Control System ([Figure 26.21](#))

The [CRP](#)-DNA Complex

[Bacteriophage \$\lambda\$](#) : Multiple Operators, Dual Repressors, and Models for DNA Binding Specificity ([Figure 26.23](#))

Genes and Mutations in the λ System ([Table 26.2](#))

The λ **cI** repressor and its Operators ([Figure 26.24](#), [Figure 26.26](#))

Early Genes in Phage λ

[Interactions Between the Two \$\lambda\$ Repressors](#) ([Figure 26.27](#))

[Structure of Cro and cI Repressors and Related DNA-Binding Proteins](#) ([Figure 26.28](#), [Figure 26.29](#), [Figure 26.30](#), [Figure 26.31](#))

The **SOS Regulon**: Activation of Multiple Operons by a Common Set of Environmental Signals ([Figure 26.32](#))

Biosynthetic Operons: Ligand-Activated Repressors and Attenuation ([Figure 21.14](#), [Figure 26.33](#), [Figure 26.35](#), [Figure 26.36](#), [Figure 26.15](#))

Other Forms of Regulation

The [Galactose Operon](#) ([Figure 26.38](#))

The [Arabinose Operon](#) ([Figure 26.39](#))

Control by [Antisense RNA](#) ([Figure 26.40](#))

The [Stringent Response](#)

Posttranscriptional Processing

[mRNA Turnover](#)

[Posttranscriptional Processing in the Synthesis of rRNA and tRNA](#)

rRNA Processing ([Figure 26.41](#))

tRNA Processing ([Figure 26.42](#))

chapter twenty-five

outline | concepts
terminology | quizzing

1	2	3	4
5	6	7	8
9	10	11	12
13	14	15	16
17	18	19	20
21	22	23	24
25	26	27	28

help | index

Outline

[Introduction \(Figure 25.1\)](#)

[DNA Methylation \(Figure 25.3\)](#)

[Restriction and Modification](#)

[Biology of Restriction and Modification \(Figure 25.5, Figure 25.6\)](#)

[Properties of Restriction and Modification Enzymes \(Table 25.1\)](#)

[Type I](#)

[Type II \(Table 25.2, Figure 25.7\)](#)

[Type III](#)

[DNA Repair](#)

[Types and Consequences of DNA Damage](#)

[Biologically Significant DNA Photoproducts: Pyrimidine Dimers \(Figure 25.9\)](#)

[Direct Repair of Damaged DNA Bases: Photoreactivation and Alkyltransferases](#)

[Photoreactivation \(Figure 25.10\)](#)

[⁶O⁶-Alkylguanine Alkyltransferase \(Figure 25.11\)](#)

[Nucleotide Excision Repair: Excinucleases \(Figure 25.12, Figure 25.13\)](#)

[Base Excision Repair: DNA-N-Glycosylases \(Figure 25.14\)](#)

[Postreplication Repair: Recombinational Repair and the SOS Response \(Item #1, p. 919\)](#)

[Recombinational Repair \(Figure 25.15\)](#)

Error-Prone Repair and the [SOS Response](#)

[Mismatch Repair \(Figure 25.16\)](#)

[Recombination](#)

[Classification of the Recombination Processes \(Figure 25.17, Table 25.3\)](#)

[Homologous Recombination](#)

Breaking and Joining of Chromosomes ([Figure 25.18](#), [Figure 4.14](#), [Figure 25.19](#))

Models for Recombination ([Figure 25.20](#), [Figure 25.22](#))

Proteins Involved in Homologous Recombination ([Figure 25.23](#), [Figure 25.24](#), [Figure 25.28](#), [Figure 25.29](#), [Figure 25.30](#))

Site-Specific Recombination ([Figure 25.31](#))

Gene Rearrangements

Immunoglobulin Synthesis: Generating Antibody Diversity ([Figure 25.32](#), [Figure 25.33](#))

Transposable Genetic Elements ([Figure 25.34](#), [Figure 25.35](#), [Table 25.4](#), [Figure 25.36](#), [Figure 25.37](#))

Retroviruses ([Figure 25.38](#), [Figure 25.35](#), [Figure 25.39](#))

Gene Amplification ([Figure 25.41](#))

chapter twenty-two

outline | concepts
terminology | quizzing

1	2	3	4
5	6	7	8
9	10	11	12
13	14	15	16
17	18	19	20
21	22	23	24
25	26	27	28

help | index

Outline

Introduction

Outlines of Pathways in Nucleotide Metabolism

Biosynthetic Routes: *De Novo* and Salvage Pathways ([Figure 22.1](#))

Nucleic Acid Degradation and the Importance of Nucleotide Salvage ([Figure 22.2, Diagram](#))

PRPP: A Central Metabolite in *De Novo* and Salvage Pathways ([Diagram 1, #2](#))

De Novo Biosynthesis of Purine Nucleotides

Early Studies on *De Novo* Purine Synthesis ([Figure 22.3, Diagram](#))

Purine Synthesis from PRPP to Inosinic Acid ([Figure 22.4, Figure 22.5](#))

Synthesis of ATP and GTP from Inosinic Acid ([Figure 22.6, Diagram 1, #2](#))

Utilization of Adenine Nucleotides in Coenzyme Biosynthesis

Purine Degradation and Clinical Disorders of Purine Metabolism

Formation of Uric Acid ([Figure 22.7, Figure 22.8](#))

Excessive Accumulation of Uric Acid: Gout ([Figure 22.9, Figure 22.4](#))

Dramatic Consequences of a Severe HGPRT Deficiency: Lesch-Nyhan Syndrome

Unexpected Consequences of Defective Purine Catabolism: Immunodeficiency ([Diagram](#))

Pyrimidine Nucleotide Metabolism

De Novo Biosynthesis of the Pyrimidine Ring ([Figure 22.10](#))

Control of Pyrimidine Biosynthesis in Bacteria

Multifunctional Enzymes in Eukaryotic Pyrimidine Synthesis ([Diagram](#))

Salvage Synthesis and Pyrimidine Catabolism ([Figure 22.11](#))

Deoxyribonucleotide Biosynthesis and Metabolism ([Figure 22.12](#))

Reduction of Ribonucleotides to Deoxyribonucleotides

Structure of Ribonucleotide Reductase (Figure 22.13)

Mechanism of Ribonucleotide Reduction (Figure 22.14, Figure 22.15)

Source of Electrons for rNDP Reduction (Figure 22.16, Table 22.1)

Regulation of Ribonucleotide Reductase Activity (Figure 22.13, Table 22.2)

Biosynthesis of Thymine Deoxyribonucleotides (Figure 22.17, Figure 22.18)

Deoxyuridine Nucleotide Metabolism

Salvage Routes to Deoxyribonucleotide Synthesis (Figure 22.17)

Thymidylate Synthase: A Target Enzyme for Chemotherapy (Diagram, Figure 22.20, Figure 22.22, Diagram)

Virus-Directed Alterations of Nucleotide Metabolism (Diagram, Figure 22.23)

Biological and Medical Importance of Other Nucleotide Analogs

Nucleotide Analogs as Chemotherapeutic Agents

Antiviral Nucleoside Analogs (Diagram)

Purine Salvage as a Target

Folate Antagonists (Figure 22.18)

Nucleotide Analogs and Mutagenesis (Figure 22.24)

Nucleotide-Metabolizing Enzymes as Selectable Genetic Markers (Diagram)

chapter twenty-one

outline | concepts
terminology | quizzing

1 2 3 4
5 6 7 8
9 10 11 12
13 14 15 16
17 18 19 20
21 22 23 24
25 26 27 28

help | index

Outline

Introduction

Amino Acids Related to [Citric Acid Cycle Intermediates](#) ([Figure 21.1](#))

Synthesis and Catabolism of Glutamate, Aspartate, Alanine, Glutamine, and Asparagine ([Diagram 1](#), [#2](#), [#3](#) [Figure 20.14](#))

Intermediary Metabolism of [Glutamate](#)

Biosynthesis of [Ornithine](#), [Arginine](#), and Creatine Phosphate ([Figure 21.2](#), [Figure 21.3](#), [Figure 21.10](#), [Diagram](#))

[Arginine](#) as the Precursor to [Nitric Oxide](#), a Novel Second Messenger ([Figure 21.3](#))

Biosynthesis of [Proline](#), [Hydroxyproline](#), and [Collagen](#) ([Diagram 1](#), [#2](#), [Figure 21.4](#))

γ -[Aminobutyric Acid](#) ([Diagram](#))

Other Functions of [Glutamate](#)

[Metabolism of Sulfur-Containing Amino Acids](#)

Reduction of Inorganic Sulfur ([Diagram](#))

Synthesis of [Cysteine](#) and [Methionine](#) in Plants and Bacteria ([Figure 21.5](#))

Cysteine Biosynthesis ([Diagram 1](#), [#2](#))

Methionine Biosynthesis ([Figure 21.6](#))

Methionine as the Source of Cysteine Sulfur in Animals ([Figure 21.7](#), [Figure 21.8](#), [Figure 21.9](#))

[Metabolism of Glutathione](#) ([Diagram](#))

[S-Adenosylmethionine and Biological Methylations](#) ([Figure 21.3](#), [Table 21.1](#), [Diagram](#))

[Polyamines](#) ([Figure 21.10](#), [Diagram](#))

Catabolism of Cysteine and Methionine ([Figure 21.11](#))

Aromatic Amino Acids

Biosynthesis of [Aromatic Rings](#): The [Shikimic Acid](#) Pathway ([Figure 21.12](#), [Figure 21.13](#), [Figure 21.14](#), [Diagram](#))

Biosynthesis of Histidine (Figure 21.17)

Aromatic Amino Acid Utilization in Plants (Diagram)

Aromatic Amino Acid Utilization in Animals

Tyrosine Biosynthesis (**Figure 21.18, Diagram**)

Tyrosine Utilization and Catabolism (**Figure 21.19, Figure 21.20, Figure 21.21, Diagram**)

Tryptophan (**Figure 21.16, Figure 21.22, Table 11.5, Diagram**)

Histidine (**Figure 21.23**)

Serine, Glycine, and Threonine (Figure 21.24, Diagram, Figure 21.25, Diagram)

Valine, Leucine, Isoleucine, and Lysine

Valine, Leucine, and Isoleucine (Figure 21.26, Diagram)

Lysine

Porphyrin and Heme Metabolism

Biosynthesis of Tetrapyrroles: The Succinate-Glycine Pathway (Figure 21.27, Figure 21.28, Figure 21.29, Diagram, Figure 21.30)

Degradation of Heme in Animals (Figure 21.31)

Amino Acids and Their Metabolites as Neurotransmitters and Biological Regulators

Biosynthesis of Serotonin and Catecholamines (Diagram, Figure 21.32)

Biochemistry of Neurotransmission

The Cholinergic Synapse (**Figure 21.33, Diagram**)

The Nicotinic Acetylcholine Receptor (**Figure 21.34**)

Inhibition of the Cholinergic Synaptic Transmission (**Table 11.4**)

Catecholamines and Adrenergic Neurons (Diagram**)**

Excitatory and Inhibitory Neurotransmission (**Figure 21.36, Table 21.2**)

Neurotransmitter Receptors and Psychopharmacology

chapter twenty

outline | concepts
terminology | quizzing

1	2	3	4
5	6	7	8
9	10	11	12
13	14	15	16
17	18	19	20
21	22	23	24
25	26	27	28

help | index

Outline

Introduction ([Figure 20.1](#))

Utilization of Inorganic Nitrogen: [The Nitrogen Cycle](#) ([Figure 20.2](#))

Biological [Nitrogen Fixation](#) ([Diagram](#), [Figure 20.4](#), [Figure 20.5](#))

[Nitrate Utilization](#) ([Figure 20.6](#), [Diagram 1](#), [#2](#))

Utilization of Ammonia: Biogenesis of Organic Nitrogen ([Figure 20.7](#))

[Glutamate Dehydrogenase](#): Reductive Amination of α -ketoglutarate ([Diagram 1](#), [#2](#))

[Glutamine Synthetase](#): Generation of Biologically Active Amide Nitrogen ([Diagram](#))

Regulation of Glutamine Synthetase ([Diagram](#), [Figure 20.9](#))

[Asparagine Synthetase](#): A Similar Amidation Reaction ([Diagram](#))

[Carbamoyl Phosphate Synthetase](#): Generation of an Intermediate for Arginine and Pyrimidine Synthesis ([Diagram](#))

The Nitrogen Economy: Aspects of Amino Acid Synthesis and Degradation

[Metabolic](#) Consequences of the Absence of Nitrogen Storage Compounds

Biosynthetic Capacities of Organisms ([Table 20.1](#))

[Transamination](#) ([Diagram 1](#), [#2](#), [#3](#))

[Protein Turnover](#)

Quantitative features of Protein Turnover ([Table 20.2](#))

Biological Importance of Protein Turnover

Intracellular Proteases and Sites of Turnover ([Figure 20.10](#))

Chemical Signals for Turnover

Ubiquitination ([Figure 20.11](#))

Oxidation of Amino Acid Residues

PEST Sequences

N-Terminal Amino Acid Residue

Common features of Amino Acid Degradation Pathways (Diagram, Figure 20.12)

Detoxification and Excretion of Ammonia

The Krebs-Henseleit Urea Cycle (Figure 20.13, Figure 21.2, Diagram)

Transport of Ammonia to the Liver (Figure 20.14, Diagram)

Coenzymes Involved Primarily in Nitrogen Metabolism

Pyridoxal Phosphate (Figure 20.15, Diagram 1, #2)

Tetrahydrofolate Coenzymes and One-Carbon Metabolism

Discovery and Chemistry of Folic Acid (Diagram)

Conversion of Folate to Tetrahydrofolate (Diagram 1, #2, #3)

Tetrahydrofolate in the Metabolism of Single-Carbon Units (Figure 20.17, Diagram 1, #2, #3)

B12 Coenzymes (Figure 20.18)

Coenzyme forms of B12 (Figure 20.19, Diagram 1, #2)

Action of Adenosylcobalamin (Figure 20.20)

B12 Coenzymes and Pernicious Anemia (Figure 20.22)

chapter nineteen

outline | concepts
terminology | quizzing

1	2	3	4
5	6	7	8
9	10	11	12
13	14	15	16
17	18	19	20
21	22	23	24
25	26	27	28

help | index

Outline

Introduction ([Figure 19.1](#))

Metabolism of Glycerophospholipids ([Figure 19.2](#))

Biosynthesis of Glycerophospholipids in Bacteria

Biosynthesis of Phosphatidic Acid and Polar Head Groups ([Figure 19.3](#), [Figure 19.4](#))

Control of Phospholipid Synthesis in Prokaryotes

Glycerophospholipid Metabolism in Eukaryotes ([Figure 19.2](#))

Synthesis of Phosphatidic Acid ([Diagram](#))

Pathways to Phosphatidylcholine and Phosphatidylethanolamine ([Figure 19.5](#), [Diagram 1](#), [#2](#), [#3](#))

Redistribution of Phospholipid Fatty Acids: Lung Surfactant and Phospholipases ([Figure 19.6](#), [Figure 19.7](#))

Biosynthesis of Other Acylated Glycerophospholipids ([Figure 19.8](#))

Posttranslational Protein Modification by Lipids ([Figure 19.9](#))

Ether Phospholipids ([Figure 19.11](#), [Figure 19.12](#), [Diagram](#))

Intracellular Transport of Membrane Phospholipids

Metabolism of Sphingolipids ([Figure 19.13](#), [Figure 19.14](#), [Table 19.1](#), [Figure 19.16](#))

Steroid Metabolism

Some Structural Considerations ([Figure 19.17](#))

Biosynthesis of Cholesterol

Early Studies of Cholesterol Biosynthesis

Stage 1: Formation of Mevalonate ([Figure 19.18](#))

Stage 2: Synthesis of Squalene from Mevalonate ([Figure 19.19](#), [Figure 19.20](#), [Figure 19.21](#))

Stage 3: Cyclization of Squalene to Lanosterol and Its Conversion to Cholesterol ([Figure 19.22](#))

[Bile Acids \(Figure 19.23\)](#)

[Steroid Hormones \(Figure 19.24, Diagram\)](#)

Other Isoprenoid Compounds

Lipid-Soluble Vitamins

[Vitamin A \(Figure 19.25, Figure 19.26, Figure 19.27\)](#)

[Vitamin D](#)

[Vitamin E](#)

[Vitamin K](#)

Other Terpenes ([Figure 19.28](#))

[Eicosanoids: Prostaglandins, Thromboxanes, and Leukotrienes](#)

Some Historical Aspects

Structure ([Figure 19.29](#))

[Biosynthesis and Catabolism \(Figure 19.30, Figure 19.31, Figure 19.32\)](#)

[Biological Actions](#)

chapter eighteen

outline | concepts
terminology | quizzing

1 2 3 4
5 6 7 8
9 10 11 12
13 14 15 16
17 18 19 20
21 22 23 24
25 26 27 28

help | index

Outline

Introduction ([Figure 18.1](#))

Utilization and Transport of Fat and Cholesterol

5-25% of mammalian body weight is lipid

90% of this lipid is [triacylglycerols \(fat\)](#)

Fat stored in [adipocytes](#)

[Fats as Energy Reserves](#)

[Glycogen](#) binds water - fats are anhydrous

Intracellular fat contain 6 times the potential metabolic energy of glycogen

400,000 kJ of fuel in body fat, 100,000 kJ in protein, 2500 kJ in glycogen, 170 kJ in [glucose](#)

40% of Western diet calories come from fat

Fat Digestion and [Absorption](#) ([Figure 18.3](#))

[Triacylglycerols](#) come from

1. Diet
2. *de novo* biosynthesis (primarily liver)
3. Adipocyte storage

[Bile salts](#) ([Figure 18.4](#))

[Transport of Fat to Tissues: Lipoproteins](#)

Classification and Functions of Lipoproteins ([Figure 18.5](#))

Lipoproteins ([Table 18.1](#))

[Chylomicrons](#), [VLDL](#), [IDL](#), [LDL](#), [HDL](#)

Apolipoproteins ([Table 18.2](#))

Lipoproteins solubilize 500 mg of total lipid per 100 ml blood

Transport and Utilization of Lipoproteins ([Figure 18.7](#))

Chylomicrons carry dietary fat from intestines ([Figure 18.3](#))

VLDL carries triacylglycerols synthesized in liver ([Figure 18.3](#))

VLDLs are degraded to IDLs

Lipoprotein lipase (Figure 18.6)

Cholesterol Transport and Utilization in Animals (Diagram)

Phosphatidylcholine + Cholesterol \rightleftharpoons Lysolecithin + Cholesterol Ester
(catalyzed by Lecithin:Cholesterol Acyl Transferase)

LDL is lipoprotein class that is richest in cholesterol

Single molecule of B-100 apolipoprotein is LDL's primary protein component

Cholesterol primarily synthesized in liver - LDL important in transport

The LDL Receptor and Cholesterol Homeostasis (Figure 18.10)

Atherosclerosis

Familial hypercholesterolemia

LDL receptor transports cholesterol into cell by receptor mediated endocytosis

Receptors clustered into coated pits which contain clathrin

Imported cholesterol moves to endoplasmic reticulum and has 3 effects

1. Suppresses endogenous cholesterol synthesis by inhibiting HMG-CoA Reductase
2. Activates acyl-CoA:cholesterol acyltransferase (ACAT) to make acyl-cholesterol esters
3. Regulates synthesis of LDL receptor

Cholesterol, LDL, and Atherosclerosis

Unknowns

Why do diets rich in saturated fat tend to elevate serum cholesterol levels?

Why to the polyunsaturated fats called ω -3 fatty acids tend to depress levels of serum cholesterol?

Plaque formation (Atherosclerosis)

Ready oxidation of LDLs

Include peroxidation of unsaturated fatty acids, hydroxylation of cholesterol, and oxidation of amino acids in apoprotein.

LDL taken into a class of white blood cells (via scavenger receptor) at site of injury/oxidation

Unlimited uptake of LDL by white blood cells converts them to foam cells. This attracts more white cells and they form chief chemical constituents of a plaque at the site.

"Good/Bad" Cholesterol

LDL called bad cholesterol because of link to atherosclerosis

HDL called good cholesterol because high HDL levels counter atherosclerosis by transporting cholesterol back to the liver from peripheral tissues

Mobilization of Stored Fat

Begins with hydrolysis of fat to glycerol and free fatty acids (is hormonally regulated - comparable to glycogen metabolism - Figure 18.11)

Hormonal activation involves triacylglycerol lipase (= hormone-sensitive lipase)

Catalyzes release of fatty acid from position 1 or 3 of fat

Freed fatty acids bound in blood plasma to serum albumin (10 fatty acids each)

95% of energy of fat from fatty acids, 5% from glycerol

Fatty acid catabolized to acetyl-CoA

Fatty Acid Oxidation

Early Experiments (Figure 18.13)

Knoop's evidence suggested fatty acids broken into two carbon units in breakdown (Figure 18.12)

Leloir and Lehninger demonstrated fatty acid oxidation in cell-free liver homogenates

Kennedy and Lehninger showed process occurs in mitochondria

Lynen showed ATP-dependent activation of fatty acid involves linkage of carboxyl group to thiol group of coenzyme A

Fatty Acid Activation and Transport into Mitochondria (Diagram)

Fatty acyl-CoA ligases (specific for short, medium, or long chain fatty acids) catalyze formation of fatty acyl thioester conjugate with coenzyme A (**Diagram**)

Short and medium chain ligases found in mitochondria. Long chain ligase found in endoplasmic reticulum and outer mitochondrial membrane

ATP energy drives endergonic thioester formation (**Figure 18.14**)

Carnitine acyltransferase I catalyzes exchange of CoA for **carnitine** to carry acyl group into mitochondrion. **Carnitine acyltransferase II** on inside of mitochondrion catalyzes reverse reaction to yield acyl-CoA and free carnitine (**Figure 18.15**)

The **β -Oxidation Pathway** (**Figure 18.16**)

Fatty acids broken down sequentially into **acetyl-CoA** units (called **β -oxidation**)

Process similar to succinate oxidation in the **Citric Acid Cycle** (dehydrogenation, hydration, dehydrogenation, attack of CoA to β carbon to release acetyl-CoA and fatty acyl-CoA two carbons shorter than the original. (Note - unsaturated fatty acids are oxidized slightly differently).

Reaction 1: The Initial Dehydrogenation (**Diagram**, **Figure 18.17**)

Catalyzed by **fatty acyl-CoA dehydrogenase**

Electrons passed to enzyme-bound **FAD** and then to **Coenzyme Q** (like **succinate dehydrogenase**)

Reactions 2 and 3: Hydration and Dehydrogenation (**Diagram**)

Catalyzed by **enoyl-CoA hydratase** and **3-hydroxyacyl-CoA dehydrogenase**, respectively.

Electrons passed to **NAD⁺**

Reaction 4: Thiolytic Cleavage (**Diagram**)

Catalyzed by **β -ketothiolase** (thiolase)

Energy Yield from Fatty Acid Oxidation (**Diagram**)

ATP yield (including ATP from **oxidative phosphorylation**) = 129 ATP

Oxidation of Unsaturated Fatty Acids (**Table 10.1**, **Figure 18.18**)

Enoyl-CoA isomerase

2,4-dienoyl-CoA reductase

Oxidation of Fatty Acids with Odd-numbered Carbon Chains (**Diagram**, **Figure 18.19**)

Yields propionyl-CoA

Propionyl-CoA carboxylase

Methylmalonyl-CoA epimerase

Methylmalonyl-CoA mutase (B12 enzyme)

Methylmalonic acidemia

Control of Fatty Acid Oxidation

By fatty acid substrate availability by hormonal control of fat mobilization

Triacylglycerol lipase regulated by hormonally controlled cAMP regulatory cascades

Glucagon and epinephrine cause fat breakdown - leads to fatty acid accumulation

In liver, malonyl-CoA controls uptake of fatty acyl-CoAs from cytosol into mitochondria by inhibiting carnitine acyltransferase I

Peroxisomal β -Oxidation of Fatty Acids (Diagram)

FAD-linked acyl-CoA dehydrogenase transfers electrons directly to oxygen (not electron transport chain) to form hydrogen peroxide.

In animals, oxidation stops at C4 and C6 acyl-CoAs.

May have function in oxidizing very long chain fatty acids.

α -Oxidation of Fatty Acids (Figure 18.20)

Deficient in Refsum's disease - patients accumulate phytanic acid (derived from phytol)

Ketogenesis (Figure 18.21, Diagram)

Ketone body formation - occurs when acetyl-CoA levels are high

Thiolase

HMG-CoA synthase

HMG-CoA lyase

Important in starvation

Fatty Acid Biosynthesis

Relationship of Fatty Acid Synthesis to Carbohydrate Metabolism (Figure 18.22)

Acetyl-CoA from fatty acid and carbohydrate catabolism can be made into

fatty acids, but not into glucose in animals.

Early Studies of Fatty Acid Synthesis

Biosynthesis of Palmitate from Acetyl-CoA (Figure 18.23)

Synthesis of Malonyl-CoA (Diagram, Figure 18.24, Diagram)

Acetyl-CoA carboxylase (biotin-containing - is primary regulatory enzyme of pathway)

Acyl Carrier Protein (Diagram)

Same thioester linkage to fatty acid as Coenzyme A and same phosphopantetheine moiety too, but is linked to a protein instead of adenosine-3' phosphate-5' bisphosphate (Figure 18.26)

Malonyl-CoA-ACP transacylase & Acetyl-CoA-ACP transacylase

From Malonyl-ACP to Palmitate (Figure 18.27, Figure 18.23, Diagram 1, #2, #3)

Fatty acid synthase

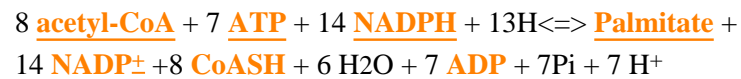

Multifunctional Proteins in Fatty Acid Synthesis (Figure 18.29, Figure 18.30)

Intermediates between acetyl-CoA and palmitate do not accumulate in cells that are synthesizing fatty acids

Transport of Acetyl Units and Reducing Equivalents into the Cytosol (Figure 18.31, Diagram 1, #2, #3, #4)

Citrate shuttle

Elongation of Fatty Acid Chains

Elongation beyond palmitate occurs in mitochondria and endoplasmic reticulum

Uses acyl-CoAs, Malonyl-CoAs, and NADPH (Diagram 1, #2)

Fatty Acid Desaturation (Table 10.1, Diagram, Figure 18.33)

Fatty acyl-CoA desaturase (Figure 18.32)

Mammals cannot introduce double bonds beyond position #9 in the fatty acid chain.

Thus, linolenic acid is an essential fatty acid

Control of Fatty Acid Synthesis

Largely hormonal control ([Figure 18.34](#))

[Insulin](#) stimulates fatty acid synthesis by stimulating [glucose](#) entry into cells and activating [pyruvate dehydrogenase complex](#).

[Acetyl-CoA carboxylase](#) inhibited by long chain fatty acyl-CoAs

[NADPH](#) may be limiting

Biosynthesis of Triacylglycerols ([Diagram 1](#), [#2](#), [#3](#))

Occurs through [glycerol-3-phosphate](#) and [diacylglycerol-3-phosphate](#) - intermediates in fat and phospholipid biosynthesis.

Variant Fatty Acid Synthesis Pathways that Lead to Antibiotics ([Figure 18.35](#))

[Polyketides](#)

[Erythromycin](#) (from *Saccharopolyspora erythraea*)

[Oxytetracycline](#) (from *Streptomyces rimosus*)

Polyketide synthesis pathway

Starts with [propionyl-CoA](#) and [Malonyl-CoA](#)

Complex lacks a dehydratase domain and two modules lack the ketoacyl reductase domain

Biochemical Insights Into Obesity

Ob gene product = leptin

[Leptin](#) is a hormone that binds receptor in brain

When leptin binds receptor, feeding behavior is controlled

[Serotonin](#) - controls satiety

[Fenfluramine](#) acts by increasing [serotonin](#) levels

chapter seventeen

outline | concepts
terminology | quizzing

1	2	3	4
5	6	7	8
9	10	11	12
13	14	15	16
17	18	19	20
21	22	23	24
25	26	27	28

help | index

Outline

Introduction ([Formula 1](#), [Figure 17.1](#), [Formula 2](#), [Figure 17.2](#))

The [Basic Processes of Photosynthesis](#) (Item [Reactions 1](#), [#2](#), [#3](#) [Table 17.1](#), [Figure 17.3](#))

[The Chloroplast](#) ([Figure 17.4c](#))

The Light Reactions

Absorption of Light: The Light-Harvesting System

[The Energy of Light](#) (Eqs. [17.1](#), [17.2](#), [Figure 17.6](#))

[Light Absorbing Pigments](#) ([Figure 17.7](#), [Figure 17.8](#))

[Light Gathering Structures](#) ([Figure 17.9](#), [Figure 17.11](#))

Photochemistry in Plants and Algae: Two Photosystems in Series ([Reaction](#), [Figure 17.3](#), [Figure 17.12](#))

[Photosystem II](#): The Splitting of Water ([Diagram 1](#), [#2](#), [Figure 17.13](#))

[Photosystem I](#): Production of NADPH ([Figure 17.12](#), [Figure 15.4](#), [Diagram](#))

[Summation](#) of the Two Systems: The Overall Reaction and ATP Generation ([Diagram 1](#), [#2](#), [#3](#), [Figure 17.15](#), [Figure 17.16](#))

An Alternate Light Reaction Mechanism: [Cyclic Electron Flow](#) ([Figure 17.17](#))

Reaction Center Complexes in Photosynthetic Bacteria ([Figure 17.19](#))

Artificial Photosynthesis

The Dark Reactions: The [Calvin Cycle](#) ([Figure 17.20](#))

Stage I: [Carbon Dioxide Fixation](#) and Sugar Production (Item [Diagram 2](#), [#2](#), [Figure 17.21](#))

Formation of Hexose Sugars ([Diagram 1](#), [#2](#))

Stage II: Regeneration of the Acceptor ([Figure 17.22](#), [Diagram](#))

A Summary of the Light and Dark Reactions In Two-System Photosynthesis

The [Overall Reaction and Efficiency](#) of Photosynthesis ([Diagram](#))

[Regulation of Photosynthesis](#) ([Figure 17.22](#), [Figure 17.23](#))

chapter sixteen

outline | concepts
terminology | quizzing

1 2 3 4
5 6 7 8
9 10 11 12
13 14 15 16
17 18 19 20
21 22 23 24
25 26 27 28

help | index

Outline

Introduction ([Figure 16.1](#))

Gluconeogenesis

Physiological Need for Glucose Synthesis in Animals ([Figure 16.2](#))

Enzymatic Relationship of Gluconeogenesis to Glycolysis ([Figure 16.3](#))

Step 1: Conversion of Pyruvate to Phosphoenolpyruvate (Reaction [#1](#), p. 557, [Figure 15.11b](#), [#2](#), [#3](#))

Step 2: Conversion of Fructose-1,6-bisphosphate to Fructose-6-phosphate (Reaction [#1](#), p. 558)

Step 3: Conversion of Glucose-6-phosphate to Glucose (Reaction [#2](#), p. 558)

Stoichiometry and Energy Balance of Gluconeogenesis (Reaction [#3](#), p. 558, [Table 16.1](#))

Substrates for Gluconeogenesis ([Figure 16.4](#))

Lactate ([Figure 16.5](#))

Amino Acids

Glycerol ([Figure 16.4](#))

Propionate (Reaction [#1](#), p. 561)

Ethanol Metabolism and Gluconeogenesis (Reaction [#1](#), p. 562)

Roles of Extrahepatic Phosphoenolpyruvate Carboxykinase

Regulation of Gluconeogenesis

Reciprocal Regulation of Glycolysis and Gluconeogenesis ([Figure 16.6](#))

Fructose-2,6-bisphosphate and the Control of Gluconeogenesis ([Figure 16.7](#))

Glycogen Biosynthesis

Glycogen Synthase and the Branching Process

Biosynthesis of UDP-Glucose ([Figure 16.8](#), [13.13b](#))

The Glycogen Synthase Reaction ([Figure 16.9](#))

Formation of Branches ([Figure 16.10](#))

Reciprocal Regulation of Glycogen Biosynthesis and Mobilization (13.18, Figure 16.11)

Phosphorylation of Glycogen Synthase

Cyclic AMP and Glycogen Synthase Regulation ([Figure 16.11](#))

A Closer Look at Glycogen Synthase Regulation: Dephosphorylation of the D Form ([Figure 16.12](#))

Functions of Glycogen Stores in Muscle and Liver

Congenital Defects of Glycogen Metabolism in Humans (Table 16.2)

Biosynthesis of Other Polysaccharides (Reaction [#1](#), p. 573, [#2](#))

Biosynthesis of Amino Sugars (Reaction [#3](#), p. 573, [Figure 16.13](#), [Figure 16.14](#), [13.14](#), Item [#1](#), p. 574, [#2](#), [#3](#), [#4](#))

Biosynthesis of Glycoconjugates

O-Linked Oligosaccharides: Blood Group Antigens (Item [#1](#), p. 575, [Figure 16.15](#))

N-Linked Oligosaccharides: Glycoproteins ([Figure 16.16](#), Item [#1](#), p. 577, [#2](#))

Synthesis of the Lipid-Linked Intermediate ([Figure 16.17](#))

Processing of the Oligosaccharides ([Figure 16.18](#))

Processing and Intracellular Protein Traffic

Microbial Cell Wall Polysaccharides: Peptidoglycan ([Figure 9.26](#))

Synthesis of N-Acetylmuramylpeptide (Item [#1](#), p. 580, [Figure 16.19](#), [Figure 16.21](#))

Formation of the Peptidoglycan Chain (Item [#1](#), p. 582, [Figure 16.20](#))

Cross-Linking of Peptidoglycan Strands ([Figure 16.21](#))

Microbial Cell Wall Polysaccharides: O Antigens ([Figure 16.22](#))

chapter fifteen

outline | concepts
terminology | quizzing

1	2	3	4
5	6	7	8
9	10	11	12
13	14	15	16
17	18	19	20
21	22	23	24
25	26	27	28

help | index

Outline

Introduction ([Figure 15.1](#))

The [Mitochondrion](#): Scene of the Action ([Figure 15.2](#))

[Oxidations and Energy Generation](#) ([Figure 15.3](#))

Quantitation of Reducing Power: [Standard Reduction Potential](#) (Reaction [#1](#), [#2](#), [#3](#), [#4](#), [Table 15.1](#))

Free Energy Changes from Oxidation-Reduction Reactions (Eq. [15.1](#))

Free energy Changes Under Standard Conditions (Reaction [#1](#), [#2](#), [#3](#), Eqs. [15.2](#), [15.3](#))

Free Energy Changes Under Nonstandard Conditions (Eqs. [15.4](#), [15.5](#))

Free Energy Changes in Biological Oxidations ([Reaction](#), [Eq. 15.6](#))

[Electron Transport](#)

Electron Carriers in the Respiratory Chain ([Figure 15.3](#), [Table 15.1](#))

NADH and NADH Dehydrogenase (Reaction [#1](#), [#2](#), [#3](#) [Figure 15.4](#))

[Coenzyme Q](#) ([Figure 15.3](#), [Reaction](#))

[Cytochromes](#) ([Figure 15.5](#), [Figure 15.6](#))

Determining the Sequence of Respiratory Electron Carriers ([Figure 15.7](#))

[Difference Spectra](#) ([Figure 15.8](#))

[Inhibitors and Artificial Electron Acceptors](#) ([Figure 15.9](#))

Respiratory Complexes ([Figure 15.10](#))

[Shuttling Electron Carriers into Mitochondria](#) ([Figure 15.11](#))

[Oxidative Phosphorylation](#)

[The P/O Ratio](#): Efficiency of Oxidative Phosphorylation ([Reaction](#))

Oxidative Reactions that Drive ATP Synthesis ([Figure 15.12](#))

The Enzyme System for ATP Synthesis ([Figure 15.14](#))

Mechanism of Oxidative Phosphorylation: Chemiosmotic Coupling (Figure 15.15)

A Closer Look at Chemiosmotic Coupling: The Experimental Evidence

Membranes Can Establish Proton Gradients (Eq. 15.7)

An Intact Inner Membrane is Required for Oxidative Phosphorylation

Key Electron Transport Proteins Span the Inner Membrane

Uncouplers Act by Dissipating the Proton Gradient

Generation of a Proton Gradient Permits ATP Synthesis Without Electron Transport

Structural Insights into Oxidative Phosphorylation (The F₀F₁ Complex) (Figure 15.16, Figure 15.18, Figure 15.19, Figure 15.20)

Respiratory States and Respiratory Control (Figure 15.22, Figure 15.23)

Mitochondrial Transport Systems (Figure 15.24)

Energy Yields from Oxidative Phosphorylation (Reactions)

Oxygen as a Substrate for Other Metabolic Reactions

Oxidases and Oxygenases (Reaction #1, #2, #3, #4)

Cytochrome P450 (Figure 15.25)

Reactive Oxygen Species, Antioxidant Defenses, and Human Disease

Formation of Reactive Oxygen Species

Dealing with Oxidative Stress (Reaction #1, #2, #3)

Oxygen Metabolism and Human Disease

chapter fourteen

outline | concepts
terminology | quizzing

1	2	3	4
5	6	7	8
9	10	11	12
13	14	15	16
17	18	19	20
21	22	23	24
25	26	27	28

help | index

Outline

Introduction ([Figure 14.1](#))

Overview of Pyruvate Oxidation and the Citric Acid Cycle

The Three Stages of [Respiration](#) ([Figure 14.2](#))

[Strategy](#) of the Citric Acid Cycle ([Figure 14.3](#))

Oxidation

Dehydrogenases

Oxidases

Oxygenases

Discovery of the Citric Acid Cycle ([Structures](#))

[Pyruvate Oxidation: A Major Entry Route for Carbon into the Citric Acid Cycle](#) ([Reaction](#), [Figure 14.4](#))

[Acetyl-CoA](#) sources

Pyruvate - [oxidative decarboxylation by pyruvate dehydrogenase](#)

Fatty Acids

Amino Acids

[Coenzymes](#) Involved in Pyruvate Oxidation and the Citric Acid Cycle

[Thiamine Pyrophosphate](#) ([Figure 14.6](#))

[Role in Decarboxylation](#)

[Lipoic Acid](#)

[Role as Acyl Carrier and Electron Carrier](#)

[Flavin Coenzymes](#) ([Figure 14.7](#), [Figure 14.8](#))

[Role as Electron Acceptor](#)

[Coenzyme A](#) and the Activation of Acyl Groups ([Reaction](#), [Figure 14.9](#))

Free thiol end of Coenzyme A used to linked to acetyl and acyl groups

Action of the Pyruvate Dehydrogenase Complex (Reactions, mechanisms, Figure 14.10)

The Citric Acid Cycle (Figure 14.3)

Enzymes / Intermediates / Summary / of the citric acid cycle

Phase 1: Introduction and Loss of Two Carbon Atoms

Step 1: Introduction of Two Carbon Atoms as Acetyl-CoA (Reaction, Figure 14.11)

Step 2: Isomerization of Citrate (Reactions, Reaction, specificity of aconitase, fluoroacetate).

Step 3: Generation of CO₂ by an NAD⁺ Linked Dehydrogenase (Reaction, Figure 14.13)

Step 4: Generation of a Second CO₂ by a Multienzyme Complex (Reaction, Figure 14.14, Figure 14.10)

Phase 2: Regeneration of Oxaloacetate

Step 5: A Substrate-Level Phosphorylation (Reaction, Reaction 2, Figure 14.15, more)

Step 6: A Flavin-Dependent Dehydrogenase (Reaction, structure)

Step 7: Hydration of a Carbon-Carbon Double Bond (Reaction)

Step 8: A Dehydrogenation That Regenerates Oxaloacetate (Reaction)

Stoichiometry and Energetics of the Citric Acid Cycle (Table 14.1, Reaction, Reaction 2)

Regulation of Pyruvate Dehydrogenase and the Citric Acid Cycle (Figure 14.16)

Control of Pyruvate Oxidation (Figure 14.10, Figure 14.17)

Regulation of the Pyruvate Dehydrogenase Complex

Control of the Citric Acid Cycle (Figure 14.3) (Summary)

NAD⁺/NADH ratio

Citrate Levels

Isocitrate dehydrogenase (Activated by ADP, inactivated by NADH)

α-Ketoglutarate dehydrogenase (Inhibited by Succinyl-CoA and NADH)

Substrate availability for Citrate Synthase

Anaplerotic Sequences: The Need to Replace Cycle Intermediates (Figure 14.18)

Reactions that Replenish Oxaloacetate (Reaction, Figure 14.19, Reaction)

Pyruvate Carboxylase (allosterically activated by acetyl-CoA)

Phosphoenolpyruvate Carboxylase

The Malic Enzyme (Reaction)

Reactions Involving Amino Acids (Reaction, Reaction 2)

Transamination (Glutamate and Aspartate)

Glutamate dehydrogenase

Glyoxylate Cycle: An Anabolic Variant of the Citric Acid Cycle (Figure 14.21, Reaction, Reaction 2, Reaction 3, Reaction 4)

Enzymes / Intermediates / Summary / of the Glyoxylate Cycle

Bypasses decarboxylations of Citric Acid Cycle (Figure 14.20)

Allows net synthesis of glucose from acetyl-CoA

Occurs in plants (glyoxysomes) and some microorganisms

A Biosynthetic Pathway That Oxidizes Glucose: The Pentose Phosphate Pathway (Figure 14.22)

Enzymes / Intermediates / Summary / of the Pentose Phosphate Pathway

Functions

Provide NADPH for biosynthetic reactions

Provide Ribose-5-phosphate for nucleotide biosynthesis

Provide means of metabolizing dietary pentoses

Variant of pathway functions in plants to fix carbon in photosynthesis

The Oxidative Phase: Generation of Reducing Power as NADPH (Figure 14.23)

The Nonoxidative Phase: Alternative Fates of Pentose Phosphates

Production of Six-Carbon and Three-Carbon Sugar Phosphates (Reaction #1, #2, #3, #4, #5, #6, #7, #8, Figure 14.24)

Tailoring the Pentose Phosphate Pathway to Specific Needs (Figure 14.25)

When nucleotide biosynthesis is needed, ribose-5-phosphate is the primary product.

When NADPH is needed, cycling of fructose and glucose phosphates is favored

When energy is the primary need, glycolysis and citric acid cycle intermediates are favored products.

Human Genetic Disorders Involving Pentose Phosphate Pathway Enzymes (Structure, Reaction, Reaction 2, Reaction 3)

Prone to Oxidative Stress (Due to deficiency of glucose-6-phosphate dehydrogenase)

Wernicke-Korsakoff syndrome (transketolase deficiency)

chapter thirteen

outline | concepts
terminology | quizzing

1 2 3 4
5 6 7 8
9 10 11 12
13 14 15 16
17 18 19 20
21 22 23 24
25 26 27 28

help | index

Outline

Introduction ([Figure 13.1](#))

Anaerobic Metabolism

Glycolysis Overview ([Figure 13.3](#))

Relation to Other Pathways

Entry Point for Hexose Sugars ([Figure 13.12](#))

Energy Investment/Generation ([Figure 13.2](#))

Anaerobic/Aerobic Glycolysis

Early Atmosphere

Reoxidize **NADH** to Maintain Steady State

Fermentation (no net change in oxidation state) = Anaerobic Glycolysis

Pyruvate/Lactate

Alcohol DH

Respiration (oxidative breakdown and energy release by reaction with oxygen)

Respiration Using Oxygen = Aerobic Glycolysis

Crucial Early Experiments

Buchners - 1897 - Cell Free fermentation

Harden/Young - 1905 Phosphate Stimulates fermentation of glucose

Emden/Meyerhof/Warburg - 1930s - [Reactions of glycolysis](#)

Strategy of Glycolysis

Glycolysis occurs in cytosol

Overview ([Figure 13.3](#))

1,3BPG and **PEP** energy of hydrolysis ([Figure 3.7](#))

Types of phosphorylation

Substrate-level (Glycolysis)

Oxidative phosphorylation (Driven by electron transport)

Photophosphorylation (Photosynthesis)

Reactions of Glycolysis

Energy Investment ([Figure](#))

Reaction 1 - [Structures](#) / [Enzyme](#) / [Summary](#)

Reaction 2 - [Structures](#) / [Enzyme](#) / [Summary](#)

Reaction 3 - [Structures](#) / [Enzyme](#) / [Summary](#)

Reaction 4 - [Structures](#) / [Enzyme](#) / [Summary](#) ([Figure 13.4](#))

Reaction 5 - [Structures](#) / [Enzyme](#) / [Summary](#)

Energy Generation ([Figure on page 454](#))

Reaction 6 - [Structures](#) / [Enzyme](#) / [Summary](#) ([Figure 13.5](#))

Reaction 7 - [Structures](#) / [Enzyme](#) / [Summary](#)

Reaction 8 - [Structures](#) / [Enzyme](#) / [Summary](#)

Reaction 9 - [Structures](#) / [Enzyme](#) / [Summary](#)

Reaction 10 - [Structures](#) / [Enzyme](#) / [Summary](#)

Overall Summary ([Table 13.1](#))

Metabolic Fates of Pyruvate ([Pyruvate/Lactate/Ethanol Metabolism](#))

[Lactate](#) Metabolism

[Lactate Dehydrogenase Reaction](#)

[Isoenzymes](#) of Lactate Dehydrogenase

[Ethanol](#) Metabolism

[Pyruvate decarboxylase](#) / [Alcohol dehydrogenase](#) ([Figure](#))

[Thiamine pyrophosphate](#) requirement

Energy And Electron Balance Sheets ([Figure 13.6](#))

[ATP Energy Summaries of Glycolysis](#)

[Glucose -> 2 Lactate](#) (lactic acid fermentation)

[Glucose -> 2 Ethanol](#) (alcoholic fermentation)

[Glucose -> 2 Pyruvate](#) (aerobic subtotal)

[2 NADH -> 6 ATP](#) (aerobic conversion)

[Glucose -> 2 Pyruvate overall](#) (oxidative)

Metabolism to [lactate](#) or [ethanol](#) non-oxidative

More ATPs from Citric Acid Cycle (38 total)

[Regulation of Glycolysis](#)

The Pasteur Effect

Inhibition of glycolysis by oxygen

Intermediates after F6P decrease with O₂

Oscillations of Glycolytic Intermediates

Activity of glycolysis depends on adenylate energy charge ([Figure 13.8](#))

Allosteric Regulation of [Phosphofruktokinase](#)

PFK Activator = [Fructose-2,6-bisphosphate](#) ([Figure 13.9](#))

PFK-2

Phosphorylation/dephosphorylation - Figure 16.7

Other PFK Activators = AMP, ADP

PFK Inhibitors = ATP and Citrate

PFK is the enzyme through which adenylate energy charge is controlled

Control of Pyruvate Kinase

Inhibitors = ATP and Acetyl CoA

Feedforward Activation by F1,6BP

Glycolysis as Both a Catabolic and an Anabolic Pathway

(Relationship of Glycolysis to Other Metabolic Pathways)

Biosynthetic intermediates from glycolysis (Figure 13.10)

Regulatory relationships with other pathways (Figure 13.11)

Entry of Other Sugars into the Glycolytic Pathway

Catabolism of Other Saccharides

Monosaccharide Metabolism (Figure 13.12)

Galactose Utilization (Summary)

Derived from Lactose

Conversion to glucose-6-phosphate (Figure 13.13)

Galactose-1-phosphate formation by galactokinase

UDP-galactose formation (UDP-Glc:GalP uridylyl transferase)

UDP-glucose formation (UDP-galactose 4-epimerase) (Figure 13.14)

Galactose-1-phosphate release (UDP-Glc:GalP uridylyl transferase)

Conversion to glucose-6-phosphate (phosphoglucomutase)

Lactose synthesis in milk

Lactose synthase

Galactosemia

Fructose Utilization

Fructose-6-phosphate (from hexokinase)

Fructose-1-phosphate (from fructokinase then cleavage by aldolase B)

Mannose Utilization

Mannose-6-phosphate formation (catalyzed by hexokinase)

Conversion of mannose-6-phosphate to fructose-6-phosphate

Disaccharide Metabolism (See Figure)

Maltose -> 2 Glucose (catalyzed by maltase)

Lactose -> Galactose + Glucose (catalyzed by lactase)

Sucrose -> Fructose + Glucose (catalyzed by sucrase)

Lactose intolerance

Bacterial sucrose enzyme (sucrose phosphorylase)

Glycerol Metabolism

From fat digestion

Glycerol kinase (glycerol -> glycerol-3-phosphate)

Glycerol-3-phosphate dehydrogenase (glycerol-3-phosphate -> DHAP)

Catabolism of Polysaccharides

Hydrolytic and Phosphorolytic Cleavages (Figure 13.15)

Phosphorylase vs. phosphatase
Energy considerations

Starch and Glycogen Digestion

α -Amylase (Figure 13.16)

In saliva
Cleaves internal $\alpha(1,4)$ linkages of starch and glycogen
Limit Dextrin

Glycogen Mobilization (Glycogen Breakdown)

Glycogen phosphorylase

Starch phosphorylase
Debranching activity (Figure 13.17)
Conversion of glucose-1-phosphate to glucose-6-phosphate

Phosphoglucomutase

Regulation of Glycogen Breakdown (Figure 13.18)

Structure of glycogen phosphorylase

Phosphorylation by phosphorylase b kinase (Calmodulin effects)

Dephosphorylation by phosphorylase phosphatase

Control of Phosphorylase Activity

Phosphorylase b kinase activation by cAMP-dependent protein kinase

Reciprocal effect on glycogen synthesis

Role of epinephrine

Kinase cascade

Proteins in the Glycogenolytic Cascade

Adenylate cyclase

cAMP-dependent protein kinase

Phosphorylase b kinase

Calmodulin (Figure 13.20)

Glycogen phosphorylase

Nonhormonal Control of Glycogenolysis

Activation of glycogen phosphorylase b by AMP

chapter twelve

outline | concepts
terminology | quizzing

1	2	3	4
5	6	7	8
9	10	11	12
13	14	15	16
17	18	19	20
21	22	23	24
25	26	27	28

help | index

Outline

Introduction

A First Look at Metabolism ([Figure 12.1](#))

Freeways on the Metabolic Road Map ([Figure 12.2](#))

[Central Pathways of Energy Metabolism](#) ([Figure 12.3](#), [Figure 12.4](#), [Figure 12.5](#), [Figure 12.6](#), [Figure 12.7](#), [Figure 12.8](#))

[Distinct Pathways for Biosynthesis and Degradation](#) ([Reactions, p. 422](#))

Some Bioenergetic Considerations

[Oxidation as a Metabolic Energy Source](#)

Biological Oxidations: Energy Release in Small Increments ([Reaction](#))

Energy Yields, respiratory Quotients, and Reducing Equivalents ([Reaction](#), [Reaction 2](#), [Reaction 3](#), [Figure 12.9](#))

[ATP as Free Energy Currency](#) ([Reaction](#), [Reaction 2](#), [Figure 3.7](#))

Thermodynamic Properties of [ATP](#)

[The Importance of Differences Between \$\Delta G'\$ and \$\Delta G^{\circ}\$](#)

[Other High-Energy Nucleotides](#)

Adenylate Energy Charge

Major [Metabolic Control Mechanisms](#)

[Control of Enzyme Levels](#)

[Control of Enzyme Activity](#) ([Figure 12.10](#))

[Compartmentation](#) ([Figure 12.11](#))

[Hormonal Regulation](#) ([Figure 12.13](#))

[Distributive Control of Metabolism](#)

Experimental Analysis of [Metabolism](#)

Goals for the Study of Metabolism

Levels of Organization at Which Metabolism is Studied

Whole Organism (Figure 12.14)

Isolated or Perfused Organ

Whole Cells

Cell-Free Systems

Purified Components

Metabolic Probes (Figure 12.15)

chapter eleven

outline | concepts
terminology | quizzing

1	2	3	4
5	6	7	8
9	10	11	12
13	14	15	16
17	18	19	20
21	22	23	24
25	26	27	28

help | index

Outline

Introduction

The Role of Enzymes

Chemical Reaction Rates and the Effects of Catalysts

Reaction Rates and Reaction Order

First-Order Rates: The Rate Constant (Equations [11.1](#), [11.2](#), [11.3](#), [11.4a](#), [11.4b](#), [Figure 11.1](#), Eqs. [11.5](#), [11.6a](#), [11.6b](#))

Second-Order Reactions (Equation [11.7](#))

Transition States and Reaction Rates ([Figure 11.2](#), Eqs. [11.8](#), [11.9](#), [11.10](#), [11.11](#), [Figure 11.3](#), Eqs. [11.12](#), [11.13](#))

What a Catalyst Does ([Figure 11.4](#), [Figure 11.5](#), [Figure 11.6](#))

How Enzymes Act as Catalysts: Principles and Examples

General Principles: The Induced Fit Model ([Figure 11.7](#), [Figure 11.8](#), [Reaction](#))

Triose Phosphate Isomerase ([Reaction](#), [Figure 11.9](#), [Reaction](#), [Reactions](#), [Figure 11.10](#))

Serine Protease ([Table 5.4](#), [Figure 11.11](#), [Figure 11.12](#), [Figure 11.13](#))

The Kinetics of Enzymatic Catalysis

Reaction Rate for a Simple Enzyme-Catalyzed Reaction: Michaelis-Menten Kinetics ([Reaction](#), Eqs. [11.14](#), [11.15](#), [11.16](#), [Figure 11.14](#), Eqs. [11.17](#), [11.18](#), [11.19](#), [11.20](#), [11.21](#), [11.22](#), [11.23](#), [11.24](#), [Figure 11.15](#), Eqs. [11.25](#), [11.26](#))

Expressing Reaction Rates for Multistep Reactions ([Reaction](#), [Equation 11.27](#))

The Significance of K_M , k_{CAT} , and k_{CAT}/K_M ([Table 11.1](#), Eqs. [11.28](#), [11.29](#), [Table 11.2](#))

Analysis of Kinetic Data: Testing the Michaelis-Menten Equation ([Figure 11.16](#), eqs. [11.30a](#), [11.30b](#), [11.31](#), [11.32](#), [11.33](#), [Figure 11.17](#))

Multisubstrate Reactions

Random Substrate Binding (Scheme [#1](#), [#2](#), [#3](#), [#4](#))

Ordered Substrate Binding

The "Ping-Pong" Mechanism

A Closer Look at Some Complex Reactions ([Scheme](#), Eqs. [11.34](#), [11.35a](#), [11.35b](#), [11.35c](#), [Figure 11.18](#), [Table 11.3](#))

Enzyme Inhibition

Reversible Inhibition

Competitive Inhibition ([Figure 11.19](#), [Scheme](#), Eqs. [11.36](#), [11.37a](#), [11.37b](#), [Figure 11.20](#), [Figure 11.21](#))

Noncompetitive Inhibition ([Figure 11.22](#), [Scheme](#), Eqs. [11.38](#), [11.39](#), [Figure 11.23](#))

Irreversible Inhibition ([Table 11.4](#), [Figure 11.24](#))

Coenzymes, Vitamins, and Essential Metals

Coenzymes and What They Do ([Table 11.5](#), [Structure](#), [Figure 11.25](#), [Figure 11.26](#))

Metal Ions in Enzymes ([Figure 11.27](#))

The Diversity of Enzymatic Function

Classification of Protein Enzymes ([Table 11.7](#))

1. Oxidoreductases catalyze oxidation-reduction reactions.
2. Transferases catalyze transfer of functional groups from one molecule to another.
3. Hydrolases catalyze hydrolytic cleavage
4. Lyases catalyze removal of a group from or addition of a group to a double bond, or other cleavages involving electron rearrangement.
5. Isomerases catalyze intramolecular rearrangement.
6. Ligases catalyze reactions in which two molecules are joined.

Molecular Engineering of New and Modified Enzymes

Site-Directed Mutagenesis

Hybrid Enzymes ([Figure 11.28](#))

Catalytic Antibodies

Nonprotein Biocatalysts: Ribozymes ([Figure 11.29](#), [Figure 11.30](#))

The Regulation of Enzyme Activity: Allosteric Enzymes

Substrate-Level Control ([Reaction](#))

Feedback Control (Scheme [#1](#), [#2](#), [#3](#))

Allosteric Enzymes

Homoallostery ([Figure 11.32](#), [Figure 11.33](#))

Heteroallostery (Figure 11.34)

Aspartate Carbamoyltransferase: An Example of an Allosteric Enzyme (Figure 11.35, Figure 11.36, Figure 11.37, Figure 11.38)

Covalent Modifications to Regulate Enzyme Activity

Pancreatic Proteases: Activation by Cleavage (Figure 11.39, Figure 11.40)

A Further Look at Activation by Cleavage: Blood Clotting (Figure 11.42)

chapter ten

outline | concepts
terminology | quizzing

1	2	3	4
5	6	7	8
9	10	11	12
13	14	15	16
17	18	19	20
21	22	23	24
25	26	27	28

help | index

Outline

Introduction

Molecular Structures and Behavior of Lipids ([Structure p. 316](#))

Fatty Acids ([Figure 10.1](#), [Table 10.1](#), [Reaction](#))

Triacylglycerols: Fats ([Structure](#), [Figure 10.2](#), [Table 10.2](#))

Soaps and Detergents ([Structure](#), [Structure 2](#))

Waxes ([Figure 10.4](#))

The Lipid Constituents of Biological Membranes ([Figure 10.5](#))

Glycerophospholipids ([Figure 10.6](#), [Table 10.3](#), [Figure 10.7](#))

Sphingolipids and Glycosphingolipids ([Structure 1, p. 324](#), [Structure](#), [Structure](#), [Figure 10.8](#))

Glycoglycerolipids

Cholesterol ([Figure 10.9](#), [Figure 10.13](#))

The Structure and Properties of Membranes and Membrane Proteins ([Figure 10.10](#))

Motion in Membranes ([Membrane Fluidity](#)) ([Figure 10.11](#))

Motion in Synthetic Membranes ([Figure 10.12](#), [Figure 10.13](#))

Motion in Biological Membranes ([Figure 10.12](#), [Figure 10.13](#))

The Asymmetry of Membranes [Figure 10.14](#)

Characteristics of Membrane Proteins ([Figure 10.15](#), [Figure 10.16](#), [Table 6.4](#), [Table 10.4](#))

The Erythrocyte Membrane: An Example of Membrane Structure ([Table 10.3](#), [Figure 10.17](#))

Separating Peripheral and Integral Proteins ([Table 10.5](#))

The Protein Skeleton ([Figure 10.18](#))

The Major Integral Membrane Proteins ([Figure 10.19](#))

Transport Across Membranes

Thermodynamics of Transport (Equations [10.1](#), [10.2](#), [10.3](#))

Passive Transport: Diffusion (Equations [10.4](#), [10.5](#), [10.6](#), [Table 10.6](#))

Facilitated Transport: Accelerated Diffusion ([Figure 10.20](#))

Pore Facilitated Transport ([Figure 10.20](#), [Figure 10.21](#), [Figure 10.22](#))

Carrier-Facilitated Transport ([Figure 10.23](#))

Distinguishing Different Types of Diffusion ([Figure 10.24](#), Equations [10.4](#), [10.5](#))

Active Transport: Transport Against a Concentration Gradient

Ion Pumps: Direct Coupling of ATP Hydrolysis to Transport ([Figure 10.25](#), Equation [10.7](#), [Figure 10.26](#))

Cotransport Systems ([Figure 10.27](#), [Table 10.7](#))

Transport by Modification ([Figure 10.28](#))

Excitable Membranes, Action Potentials, and Neurotransmission ([Figure 10.29](#))

The Resting Potential (Equations [10.8](#), [10.9](#), [10.10](#), [Figure 10.30](#))

The Action Potential ([Figure 10.31](#), [Figure 10.32](#), [Figure 10.33](#))

1. The action potential does not appreciably decrease with distance transmitted.
2. The action potential is an all-or-none phenomenon.
3. After an impulse has passed, the region of axon immediately behind it is unable to transmit another impulse for a period of some milliseconds because of the refractory period.

The Velocity of Neural Transmission ([Figure 10.34](#))

Toxins and Neurotransmission

chapter nine

outline | concepts
terminology | quizzing

1 2 3 4
5 6 7 8
9 10 11 12
13 14 15 16
17 18 19 20
21 22 23 24
25 26 27 28

help | index

Outline

Introduction ([Figure 9.1](#), [Figure 9.2](#))

Monosaccharides

Monosaccharide Nomenclature

Aldoses and Ketoses ([Figure 9.3](#), [Figure 9.4](#))

Enantiomers ([Figure 9.5](#), [Structures](#))

Alternative Designations for Enantiomers: D-L and R-S ([Figure 9.6](#))
Monosaccharide Enantiomers in Nature ([Table 9.1](#))

Diastereomers

Tetrose Diastereomers ([Figure 9.7](#), [Figure 9.8](#))
Pentose Diastereomers ([Figure 9.9a](#), [Figure 9.9b](#))
Hexose Diastereomers ([Figure 9.9a](#), [Figure 9.9b](#))

Ring Structures

Pentose Rings ([Figure 9.10](#), [Figure 9.11](#), [Table 9.2](#), [Structure](#))
Hexose Rings ([Structure](#), [Figure 9.12](#), [Figure 9.13](#))
Sugars with More Than Six Carbons ([Table 9.1](#), [Figure 9.14](#))

Derivatives of the Monosaccharides

Phosphate Esters ([Table 9.3](#), [Structure](#))

Acids and Lactones ([Structure 1](#), [Structure 2](#), [Structure 3](#))

Alditols ([Structure](#))

Amino Sugars ([Structure 1](#), [Structure 2](#), [Structure 3](#), [Table 9.4](#))

Glycosides ([Structure](#), [Figure 9.15](#))

Oligosaccharides

Oligosaccharide Structures ([Table 9.5](#), [Figure 9.16](#))

Distinguishing features of Different Disaccharides

1. The 2 Specific Sugar Monomers Involved and their Stereoconfigurations.
2. The Carbons Involved in the Linkage.

3. The Order of the Two Monomer Units, if Different
4. The Anomeric Configuration of the OH Group on Carbon 1 of Each Residue

Writing the Structure of Disaccharides ([Structure](#), [Table 9.5](#))

1. Sequence written starting with the nonreducing end at the left.
2. Anomeric and enantiomeric forms are designated by prefixes.
3. The Ring Configuration is Indicated by a Suffix
4. The Atoms Between Which Glycosidic bonds are Formed are indicated by Numbers in Parentheses Between Residue Designations.

Stability and Formation of the [Glycosidic Bonds](#) ([Figure 9.17](#))

Polysaccharides

Storage Polysaccharides ([Figure 9.19](#), [Figure 9.20](#))

Structural Polysaccharides

Cellulose ([Figure 9.21](#), [Structure](#), [Figure 9.22](#))

Chitin ([Structure](#))

Glycosaminoglycans ([Figure 9.23](#))

The [Proteoglycan](#) Complex ([Figure 9.24b](#), [Structure](#))

Nonstructural Roles of Glycosaminoglycans ([Structure](#))

Bacterial Cell Wall Polysaccharides ([Figure 9.25](#), [Figure 9.26](#), [Structure](#))

Glycoproteins ([Table 9.6](#))

N-Linked and O-Linked Glycoproteins ([Figure 9.28](#))

N-Linked Glycans ([Structure](#))

O-Linked Glycans

Blood Group Substances ([Figure 9.29](#), [Table 9.7](#))

Oligosaccharides as Cell Markers ([Figure 9.30](#))

chapter eight

outline | concepts
terminology | quizzing

1 2 3 4
5 6 7 **8**
9 10 11 12
13 14 15 16
17 18 19 20
21 22 23 24
25 26 27 28

help | index

Outline

Introduction

Muscles and Other Actin-Myosin Contractile Systems

Actin and Myosin

Actin ([Figure 8.1](#))

Myosin ([Figure 8.3](#), [Figure 6.11](#), [Figure 8.4](#))

The Reaction of Myosin and Actin

The Structure of Muscle ([Figure 8.8](#), [Figure 8.9a](#))

The Mechanism of Contraction: Sliding Filament Model ([Figure 8.10](#), [Figure 8.11](#))

Stimulation of Contraction: The Role of Calcium ([Figure 8.13](#), [Figure 8.14](#), [Figure 8.15](#))

Energetics and Energy Supplies in Muscle ([Table 8.1](#), [Figure 8.12](#), [Here](#), [Figure 12.14](#))

Nonmuscle Actin and Myosin ([Figure 8.17](#))

Microtubule Systems for Motility ([Figure 8.19](#), [Figure 8.20](#))

Motions of Cilia and Flagella ([Figure 8.22b](#), [Figure 8.23](#), [Figure 8.24](#))

Intracellular Transport ([Figure 8.27](#))

Microtubules and Mitosis ([Figure 8.28](#))

Bacterial Motility: Rotating Proteins ([Figure 8.29](#), [Figure 8.31](#))

chapter seven

outline | concepts
terminology | quizzing

1	2	3	4
5	6	7	8
9	10	11	12
13	14	15	16
17	18	19	20
21	22	23	24
25	26	27	28

help | index

Outline

Introduction ([Figure 7.1](#))

Oxygen Transport and Storage: [The Roles of Hemoglobin and Myoglobin](#) ([Figure 7.3](#))

The Mechanism of [Oxygen Binding by Heme Proteins](#)

[The Oxygen Binding Site](#) ([Figure 7.4](#), [Figure 7.5](#), [Figure 6.1](#))

[Analysis of Oxygen Binding by Myoglobin](#) (Equations [7.1](#), [7.2](#), [7.3](#), [7.4](#), [7.5](#), [7.6](#), [7.7](#), [Figure 7.6](#), [Figure 7.7](#))

Oxygen Transport: [Hemoglobin](#)

[Cooperative Binding and Allostery](#) ([Figure 7.8](#), [Figure 7.9](#), Equations [7.8](#), [7.9](#), [7.10](#), [7.11](#))

[Models of Allosteric Change in Hemoglobin](#) ([Figure 7.10](#), [Figure 7.12](#))

[Changes in Hemoglobin Structure Accompanying Oxygen Binding](#) ([Figure 7.12](#))

[A Closer Look at the Allosteric Change in Hemoglobins](#) ([Figure 7.13](#), [Figure 7.14](#), [Figure 7.15](#))

Effects of Other Ligands on the Allosteric Behavior of Hemoglobin ([Reaction](#))

[Response to pH Changes: The Bohr Effect](#) ([Reaction](#), [Figure 7.16](#))

[Carbon Dioxide Transport](#) ([Reaction](#), [Figure 7.1](#))

[Bisphosphoglycerate](#) ([Figure 7.17](#), [Figure 7.18](#), [Figure 7.19](#))

Protein [Evolution](#): [Myoglobin and Hemoglobin](#) as Examples

[The Structure of Eukaryotic Genes: Exons and Introns](#) ([Figure 7.20](#))

[Mechanisms of Protein Mutation](#) ([Table 7.1](#))

Replacement of DNA Bases ([Figure 7.21](#))

Deletions or Insertions of Bases in the Gene

Gene Duplications and Rearrangements

[Evolution of the Myoglobin/Hemoglobin Proteins](#) ([Figure 5.14](#), [Figure 7.22](#), [Figure 7.23](#), [Figure 7.10](#), [Figure 7.24](#), [Figure 7.13](#), [Figure 7.24](#))

Hemoglobin Variants: Evolution in Progress

Variants and Their Inheritance ([Figure 7.25](#), [Figure 7.26](#))

Pathological Effects of Variant Hemoglobins ([Table 7.2](#), [Figure 7.21](#))

Thalassemias: Effects of Misfunctioning Hemoglobin Genes

β -Thalassemia
 α -Thalassemias

Immunoglobulins: Variability in Structure Yields Versatility in Binding

The Immune Response ([Figure 7.29](#), [Figure 7.30](#), [Figure 7.31](#))

The Structure of Antibodies ([Table 7.3](#), [Figure 7.29](#), [Figure 7.32](#), [Figure 7.33](#), [Figure 7.36](#))

Generation of Antibody Diversity

T Cells and the Cellular Response ([Figure 7.35](#))

AIDS and the Immune Response ([Figure 7.37b](#))

chapter SIX

outline | concepts
terminology | quizzing

1	2	3	4
5	6	7	8
9	10	11	12
13	14	15	16
17	18	19	20
21	22	23	24
25	26	27	28

help | index

Outline

Introduction ([Figure 6.1](#))

Secondary Structure: Regular Ways to Fold the Polypeptide Chain

Discovery of Regular Polypeptide Structures ([Figure 5.12b](#), [Figure 6.2](#), [Figure 6.3](#), [Figure 6.4](#))

Describing the Structures: Molecular Helices and Pleated Sheets ([Figure 6.5](#), [Figure 6.6](#), [Table 6.1](#))

Ramachandran Plots ([Figure 6.2](#), [Figure 6.8](#), [Figure 6.9](#), [Figure 6.10](#))

Fibrous Proteins: Structural Materials of Cells and Tissues ([Table 6.2](#))

The Keratins ([Figure 6.11](#))

Fibroin ([Figure 6.12](#), [Table 6.2](#))

Collagen

Collagen Structure ([Figure 6.13](#), [Figure p. 179](#))

Collagen Synthesis ([Figure 6.14](#))

Elastin ([Unnumbered Figure](#))

Globular Proteins: Tertiary Structure and Functional Diversity

Different Folding for Different Functions ([Figure 6.1](#), [Figure 6.16](#))

Varieties of Globular Protein Structure: Patterns of Folding ([Figure 6.16](#), [Figure 6.17](#), [Figure 6.18](#), [Figure 6.19](#))

Factors Determining Secondary and Tertiary Structure

The Information for Protein Folding ([Figure 6.20](#))

The Thermodynamics of Folding

Conformational Entropy

Charge-Charge Interactions

Internal Hydrogen Bonds ([Figure 6.21](#))

van der Waals Interactions ([Table 6.3](#))

The Hydrophobic Effect ([Table 6.4](#), [Figure 6.22](#))

The Role of Disulfide Bonds ([Figure 6.23](#))

Dynamics of Globular Protein Structure

Kinetics of Protein Folding ([Figure 6.24](#))

Kinetics of Disulfide Bond Formation ([Figure 6.25](#))

Chaperonins ([Figure 6.26](#))

Motions Within Globular Protein Molecules ([Table 6.5](#))

Prions - Protein Folding and Mad Cow Disease ([Figure 6.27](#))

Prediction of Secondary and Tertiary Protein Structure

Prediction of Secondary Structure ([Table 6.6](#), [Figure 6.28](#))

Tertiary Structure: Computer Simulation of Folding

Quaternary Structure of Proteins ([Figure 6.29](#))

Multisubunit Proteins: Homotypic Protein-Protein Interactions ([Figure 6.30](#), [Figure 6.32](#), [Figure 6.33](#))

Heterotypic Protein-Protein Interactions

chapter five

outline | concepts
terminology | quizzing

1	2	3	4
5	6	7	8
9	10	11	12
13	14	15	16
17	18	19	20
21	22	23	24
25	26	27	28

help | index

Outline

Introduction

Protein Complexity ([Figure 5.1](#))

Amino Acids

Structure of the α -amino acids ([Figure 5.2](#), [Figure 5.3](#))

Amino group attached to α carbon (next to carboxyl carbon)

Side chains

Zwitterions

Stereochemistry of the α -amino acids ([Figure 5.4](#))

Chiral center/Stereocenter

Asymmetric carbon

Stereoisomers/Enantiomers/Optical isomers ([Figure 5.5](#))

L-amino acids (predominant form in polypeptides)

Drawn in this book with amino to left, carboxyl to right, R group on top

Glycine is only α amino acid in proteins with asymmetric carbon - so is not chiral.

D-Amino acids (rare - occur in some bacterial polypeptides)([Table 5.2](#))

It is possible to chemically synthesize proteins with D-amino acids.

Properties of Amino Acid Side chains: Classes of α -Amino Acids ([Table 5.1](#), [Figure 5.3](#))

Aliphatic side chains (a diverse group - more nonpolar ones, such as VAL, LEU, ILE prefer interior of protein molecule)

Glycine, Alanine, Valine, Leucine, Isoleucine, Proline

Hydroxyl or Sulfur-Containing Side Chains (weakly polar side chains, except MET)

Serine, Cysteine, Threonine, Methionine

Aromatic Amino Acids (Strong absorption of light in near UV) ([Figure 5.6](#))

Phenylalanine, Tyrosine, Tryptophan

Basic Amino Acids (Strongly polar, usually on exterior of proteins) ([Figure](#)

5.7)

Histidine, Lysine, Arginine

Acidic Amino Acids and Their Amides (ASP and GLU strongly acid, ASN and GLN polar but not charged. All prefer exterior of protein)

Aspartic Acid, Glutamic Acid, Asparagine, Glutamine

Modified Amino Acids

O-Phosphoserine

4-Hydroxyproline

Δ -Hydroxylysine

γ -Carboxyglutamic acid

Peptides and the Peptide Bond (Figure 5.8)

Peptides (amide bond between α amino and α carboxyl groups) (Figure 5.9, Figure 5.10)

Dipeptide contains 2 amino acids linked by a peptide bond

Oligopeptide contains a few amino acids joined by peptide bonds

Polypeptide contains many amino acids joined by peptide bonds

All proteins are polypeptides

Polypeptides as Polyampholytes (Figure 5.11)

Small pH changes can significantly alter protein charge and properties

Structure of the Peptide Bond (Figure 5.12)

Double bond character of peptide bonds makes C,N,H,O nearly coplanar (Figure 5.12)

Stability and Formation of the Peptide Bond (Unnumbered Figure, Table 5.4)

Hydrolysis of peptide bond favored energetically, but uncatalyzed reaction very slow

Strong mineral acid, such as 6 M HCl, good catalyst for hydrolysis

Proteolytic enzymes (proteases) provide catalysis for cleaving specific peptide bonds

Cyanogen bromide cleaves peptide bonds at specific point too - on carboxyl side of methionines (Figure 5.13)

Amino acids must be "activated" by ATP-driven reaction to be incorporated into proteins (Figure 5.19)

Proteins: Polypeptides of Defined Sequence (Figure 5.14, Figure 5.15)

Amino acid composition

Amino acid sequence

From Gene to Protein

The Genetic Code (Three nucleotides - codon - code for one amino acid in a protein) (Figure 5.16, Figure 5.17, Figure 5.18)

Translation (Figure 5.19, Figure 5.20)

Translation is the process of "reading" the codons and linking appropriate amino acids together through peptide bonds

tRNAs carry amino acids for translation

Translation is accomplished by the anticodon loop of tRNA forming base pairs with the codon of mRNA in ribosomes

Stop codons act to stop translation

Posttranslational Processing of Proteins (Figure 5.21)

Folding

Amino acid modification (some proteins)

Proteolytic cleavage (some proteins - insulin is an example) -

1. Insulin is synthesized as a single polypeptide called preproinsulin with leader sequence to help it be transported through the cell membrane.
2. Specific protease cleaves leader sequence to yield proinsulin.
3. Proinsulin folds into specific 3D structure and disulfide bonds form
4. Another protease cuts molecule, yielding insulin, which has two polypeptide chains

chapter four

outline | concepts
terminology | quizzing

1 2 3 4
5 6 7 8
9 10 11 12
13 14 15 16
17 18 19 20
21 22 23 24
25 26 27 28

help | index

Outline

Introduction

The Nature of Nucleic Acids

Two Types of Nucleic Acids: DNA and RNA (Figure 4.1)

Nucleotide = Base + Sugar + Phosphate (Figure 4.3)

Nucleosides = Sugar + Base (no phosphate)

Structural Difference DNA-RNA - Ribose in RNA, Deoxyribose in DNA

Phosphodiester links between nucleotides (Figure 4.1)

Purine bases - Adenine (A) and Guanine (G) (Figure 4.2)

Pyrimidine Bases - Cytosine (C), Thymine (T), Uracil (U)

Same bases in RNA and DNA except T only in DNA, U in RNA

Properties of the Nucleotides

Ionization - Table 4.1

Tautomerization (Figure 4.4)

UV Spectra (Figure 4.5)

Stability and Formation of the Phosphodiester Linkage

Dehydration - unfavorable thermodynamics (Figure 4.6)

Energy of triphosphate hydrolysis coupled to synthesis (Figure 4.7)

Primary Structure of Nucleic Acids

The Nature and Significance of Primary Structure

1. Directionality of polynucleotide chain
2. Individuality of polynucleotide chain determined by sequence of nucleotides. (Primary Structure)

Shortcut sequence listings (#1, #2)

Genetic information stored in nucleotide sequence of DNA

Gene is a particular DNA sequence

DNA as the Genetic Substance: Early Evidence (History of DNA)

Miescher first to isolate DNA from salmon sperm (late 1800s)

Avery, MacLeod, McCarty - Transfer of DNA carried pathogenicity. (Figure 4.8)

Hershey and Chase - Bacteriophage T2 transfers DNA to bacteria

Secondary and Tertiary Structure of Nucleic Acids

The Double Helix

Watson, Crick, Franklin, Wilkins
Secondary Structure from X-ray Diffraction
Refined Structure ([Figure 4.10](#))
Major and Minor Grooves ([Figure 4.11](#))
Chargaff's Rule (A=T, G=C in DNA) ([Table 4.2](#))
Complementarity allows replication ([Figure 4.12](#))

Semiconservative Nature of DNA Replication

Half of original is conserved in each of two copies of duplicated strand ([Figure 4.13](#))
Meselson and Stahl ([Figure 4.14](#))

Alternative Nucleic Acid Structures: B and A Helices ([Figure 4.15](#), [Table 4.3](#))

'B' form predominant form in cells ([Figure 4.16](#)) ([Structure of B-DNA](#))

'A' form found in double-stranded RNA and RNA/DNA hybrids
Lack of steric hindrance in B DNA enables it to accommodate water better than A form.

DNA and RNA Molecules in vivo ([Table 4.4](#))

Long Eukaryotic DNAs
Circular DNA and Supercoiling ([Figure 4.18](#))

3D Structure = Tertiary Structure
[Supercoiling](#)

Topoisomerases

Structure of Single-Strand Polynucleotides ([Figure 4.19](#), [Figure 4.20](#))

The Biological Functions of Nucleic Acids: A Preview of Molecular Biology

Genome ([Table 4.4](#))
[Genes](#)

[Transcription](#): DNA to RNA ([Figure 4.12](#), [Figure 4.21](#))

[Translation](#): RNA to Protein ([Figure 4.22](#))

Types of RNA ([Table 4.5](#))

[Codons](#)
[Genetic Code](#)

[mRNAs](#)
[Ribosomes](#)

Flow of genetic information in cell ([Figure 4.23](#))

Manipulating DNA

Recombinant DNA techniques

Plasticity of Secondary and Tertiary DNA Structure

Changes in Tertiary Structure: A Closer Look at Supercoiling (Figure 4.24)

Twist (T)

Writhe (W)

Linking number (L)

$$\Delta L = \Delta T + \Delta W$$

Unusual Secondary Structures of DNA

Left-Hand DNA (Z-DNA) (Figure 4.26)

Purines -Syn and Pyrimidines -Anti base orientations (Figure bottom p. 111)

Hairpins and Cruciforms (Figure 4.27)

Palindrome (Figure 4.28)

Triple Helices and H-DNA (Figure 4.30)

Hoogsteen base pairing (Figure 4.29)

Stability of Secondary and Tertiary Structure

The Helix-to-Random-Coil Transition: Nucleic Acid Denaturation

Loss of Secondary Structure = Denaturation (Figure 4.31)

Factors favoring dissociation of double helices to random coils

1. Electrostatic repulsion between chains
2. Higher entropy of random coil

Forces stabilizing double helices

1. Hydrogen bonds between base pairs
2. van der Waals interactions between stacked bases.

Since $\Delta G = \Delta H - T\Delta S$ (helix \rightleftharpoons random coil) and ΔH and ΔS are both positive, helix stability is a function of temperature. (Figure 4.32)

Hypochromism - absorption of light by bases reduced when in helix = denaturation causes increase in absorbance of light at 260 nm.

Cooperative transitions - Denaturation happens over a short temperature range.

Superhelical Energy and Changes of DNA Conformation

Increasing supercoiling puts DNA circles under stress. Stress may be alleviated by:

1. Melting of AT-rich regions.
2. Formation of Z-DNA in purine/pyrimidine tracts

3. Cruciform formation in palindrome sequences

4. H-DNA formation in stretches of purines/pyrimidines on one strand.

Please select a question set from the drop-down menu above.

Caution!

If you are using Internet Explorer 4.5 or greater on a Macintosh platform **DO NOT** select a question set without first downloading and installing Mac OS Runtime for Java 2.2! Running a quiz without first installing MRJ 2.2 may result in a system crash. You can download MRJ 2.2 from Apple at www.apple.com/java.